

BYTE

A MCGRAW-HILL PUBLICATION

HP's
Vectra
with
Local
Bus
Page 53



Managing Infoglut

How to Add Value to Your Data

William F. Buckley Jr. on Privacy

Special Report: Get the Most Out of Windows

7 Color PostScript Printers Under \$8000

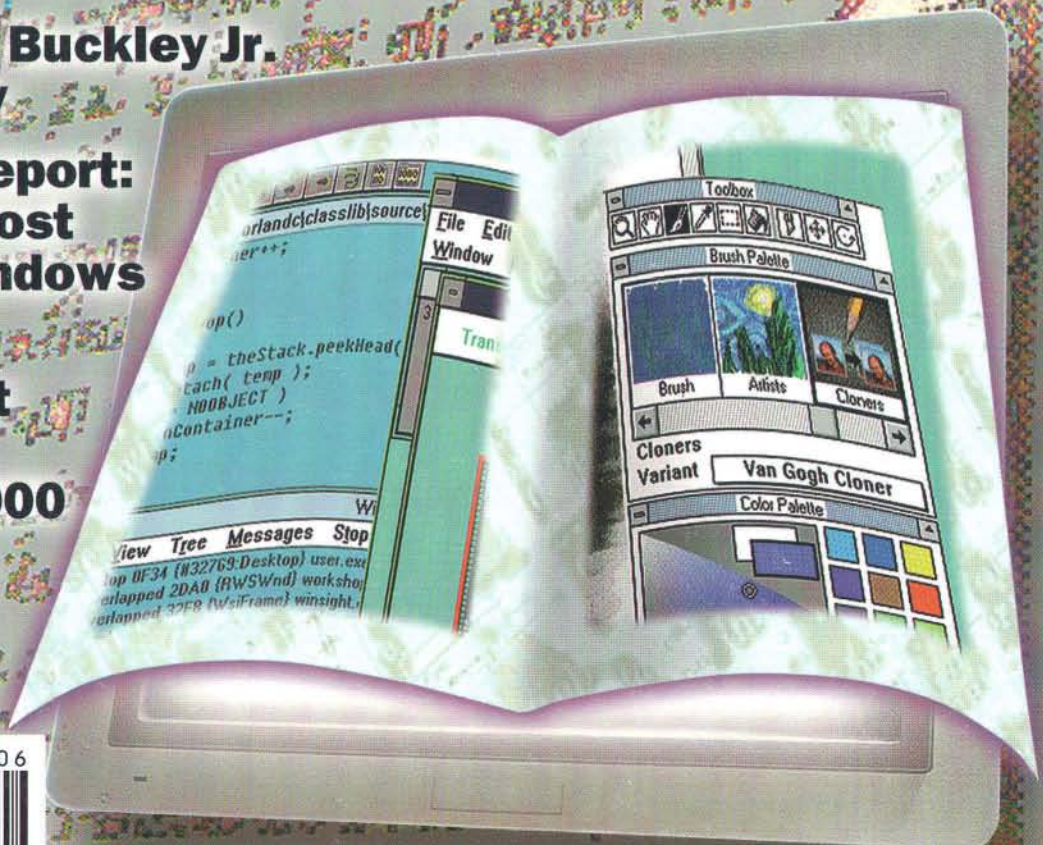

£1.95 U.K./LIT. 8,000 ITALY
\$3.50 U.S.A./0360-5280

Holy Cow!

Notebook PCs Are From Gateway 2000!



Dakota and Lexa — Gateway 2000 employees Phil and Mary — were photographed in Beautiful Rushmore Cave near Keystone in the Black Hills of South Dakota.

“Now it’s our mission to tell the world about our discovery!”

Dakota pauses. In all the excitement, he has forgotten that Lexa’s dream remains unfulfilled.

“I’m sorry, Lexa,” Dakota tries to comfort her. “I know you were hoping to find something different — more like a cross between a notebook and a palmtop.”

“You’re right. These are excellent machines, but they’re not quite what I was hoping for,” she murmurs.

“But wait!” Dakota shouts, his voice echoing through the cave. “There’s another map loaded on my Nomad.

Yes, more directions. And the arrow is pointing to something called the HandBook. Do you suppose...?” he wonders.

Dakota and Lexa hurry out of the cave. What they thought was their journey’s end has turned out to be just the beginning.

TO BE CONTINUED...





- Weight 5.8 Lbs. (Nomad & Battery)
- Dimensions 8.5" x 11" x 1.8"
- 7-Hr.* NiCad 5.7Ah Battery
- 14.4-Oz. Battery Charger, 6.12" x 2.25" x 1.5"
- Traveling Weight 6.7 Lbs. (Nomad, Battery & Charger)
- Backlit 10" VGA Screen, 640 x 480 Resolution, 64 Gray Scale
- Simultaneous Video with 1MB
- 1.44MB 3.5" Diskette Drive
- 1 Parallel/1 Serial Port
- External Video & Expansion Bus Ports (Ports are Full Size)
- 79-Key Keyboard, 101-Key Emulation, Inverted T Cursor Pad
- Pointing Device
- MS DOS 5.0 & Windows™ 3.1

NOMAD 325SXL • \$1995
25MHz, 386SXL, 2MB RAM, 80MB Hard Drive

NOMAD 420SXL • \$2795
20MHz, Intel® 486SX, 4MB RAM, 80MB Hard Drive

NOMAD 425DXL • \$3495
25MHz, Intel 486DX, 4MB RAM, 120MB Hard Drive

Nomad Options: 2,400 bps and 9,600 bps modems, portable printer, numeric keypad, expansion station, Token Ring or Ethernet interfaces, SCSI interface, memory upgrades, executive carrying case, extra batteries

**Battery life was measured using PC Magazine's Battery Run-down Test with power management enabled. Actual results may vary depending on configuration and applications.*

All prices and configurations are subject to change without notice. Prices do not include shipping.

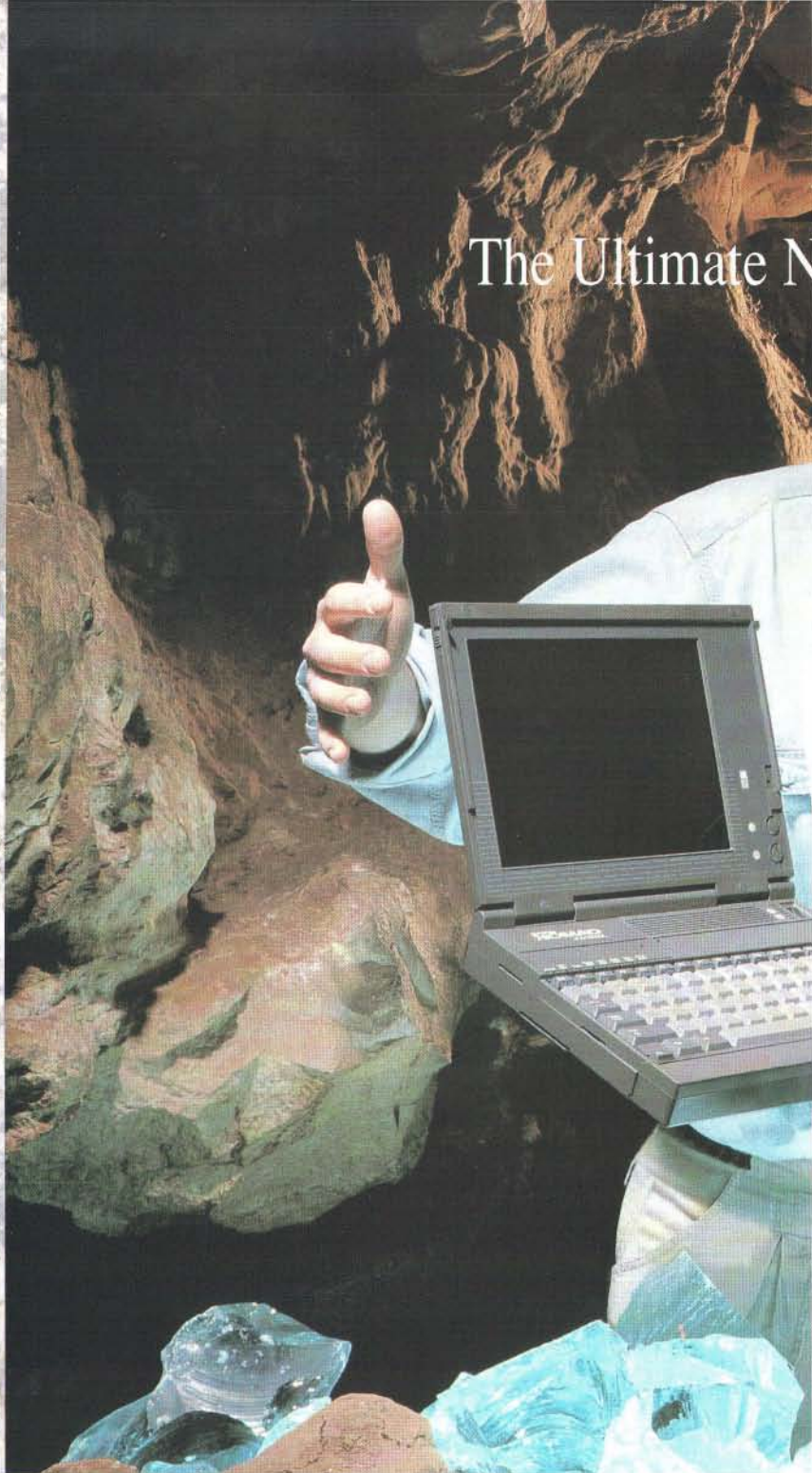

The Ultimate N

Deep inside a mysterious cave, Dakota and Lexa discover three notebooks called the Nomad Series.

NOMAD They're Dakota's dream come true — notebooks designed for serious computing on the road, all with supernatural battery life, great screens and keyboards, in a compact, lightweight model.

Dakota can't help wondering how these astonishing little machines got here. "They must have been placed in the cave by some ancient civilization advanced beyond our time, or

perhaps by beings from another galaxy," he surmises. Lexa, always probing for the truth, points out that the notebooks are clearly marked with the Gateway 2000 logo. Dakota is not satisfied. "Why would Gateway 2000 keep these wonderful notebooks hidden from the world?" he wonders.

"It must be a conspiracy!" Lexa exclaims. "An evil competitor must be behind this! The people at Gateway must have sent us the clues to discover their treasures so we could tell the world!"

"I think you're on to something, Lexa," Dakota agrees.

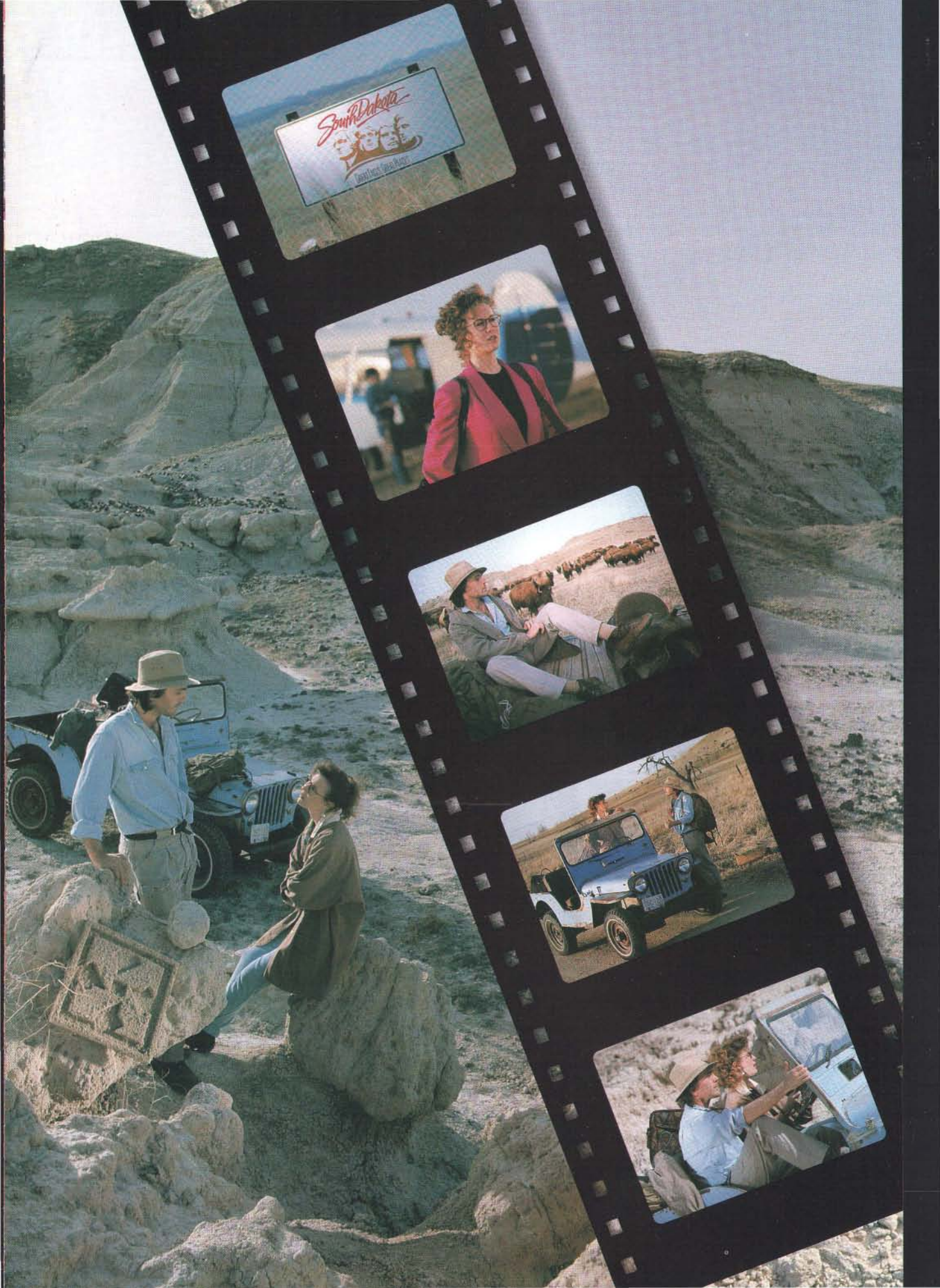

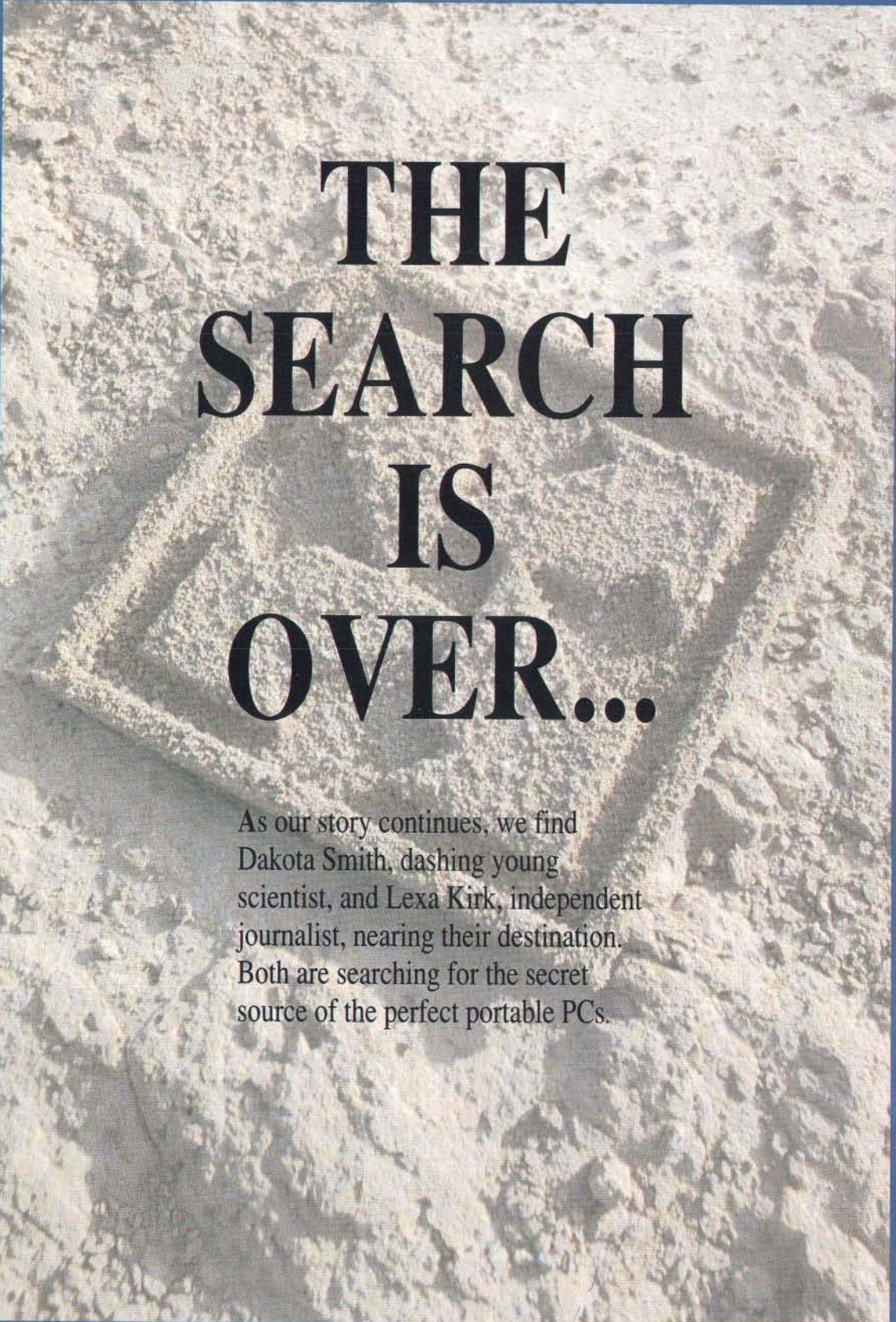
An aerial photograph of a desert landscape, showing a winding path or road that leads through a vast, arid terrain. The ground is light-colored and textured, with some darker patches and shadows. The overall scene is desolate and expansive.

THE SEARCH IS OVER...

As our story continues, we find Dakota Smith, dashing young scientist, and Lexa Kirk, independent journalist, nearing their destination. Both are searching for the secret source of the perfect portable PCs.

Introducing the alternative to accounting software.

Introducing QuickBooks, from the makers of Quicken. The first software that does your books while you conduct your business. All you do is pay bills, invoice clients, and collect deposits. QuickBooks does all the work to provide you with management information and financial statements – any time you want.

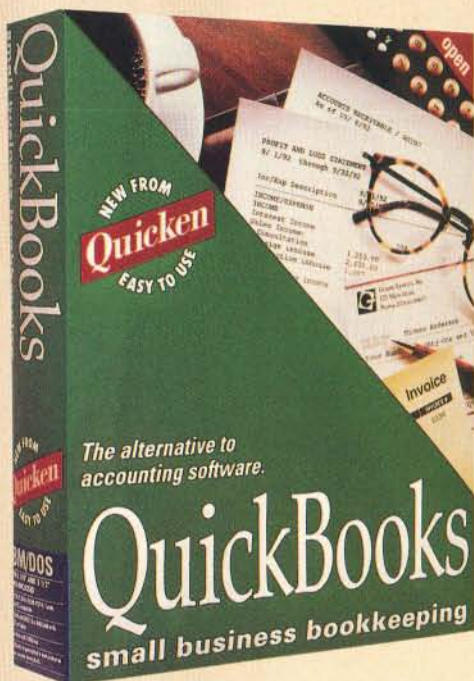

Specifications: PC compatible computer with 640K RAM and DOS 2.1 or higher. Hard disk with 2 MB free.

No accounting mumbo-jumbo. With accounting software, you had to "post" "debits and credits" and "reverse entries" in "journals" and "ledgers." You practically needed to be a CPA.

But now you can computerize your books without any accounting mumbo-jumbo.

New QuickBooks uses just plain English. If you want to pay a bill, choose "Checkbook" from the

"Checkbook" from the Main Menu.

If you want to invoice a customer, choose "Invoicing." It's that simple.



Stunningly simple to use.

Work with familiar forms.

Only enter information once.

QuickBooks remembers your recurring payments.

Flexibly assign expenses.

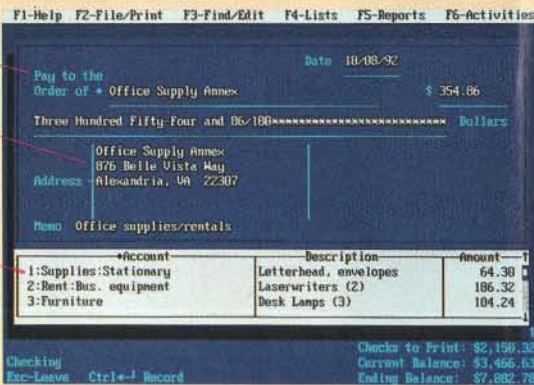

Choose whom to pay and when.

Choose Bills to Pay

Vendor	Invoice	Pay Date	Balance	Payment
Chicago Tools & Gage	856	11/11/92	682.32	588.00
Garden Supplies Inc.	12498	10/22/92	1,753.31	1,753.31
Garden Supplies Inc.	13546	11/ 4/92	3,825.52	3,825.52
New Leaf Landscaping	2456	10/25/92	1,865.62	1,865.62
New Leaf Landscaping	3578	11/ 8/92	158.00	158.00
New Leaf Landscaping	5685	11/ 9/92	236.35	236.35
Office Supply Annex	69699	12/16/92	856.36	8.00
Pine Lumber Yard	8976	11/16/92	745.32	8.00
Speedy Printing	5692	10/19/92	42.31	42.31
Checking Balance	\$8,561.83		TOTAL	7,573.11

Just select the bills you want to pay from this list.

Payments to the same vendor can be combined.

Prints checks automatically for all bills selected.

Shows your bank balance.

Totals how much you owe.

Invoice customers in minutes.

Practically no typing.

Pick here:

Customer	Balance
Bay Shore Properties	1,771.89
Bayshore Book Mook	508.75
Bayshore National Bank	0.00
BaySoft, Inc.	0.00
Catering By Stephanie	0.00

It's entered here.

Sales tax is calculated for you.

The math is done for you.



Powerful bookkeeping, easier than you ever imagined possible.

Collect money faster than ever.

All the information you need to call customers.

Quickly see who's behind.

A/R Aging

Customer	1-30	31-60	61-90	91-120	121-150	151-180	181-210	211-240	241-270	271-300	Total
Green Systems, Inc.	1,000.00	1,000.00	1,000.00	1,000.00	1,000.00	1,000.00	1,000.00	1,000.00	1,000.00	1,000.00	10,000.00
New Line Computers	1,000.00	1,000.00	1,000.00	1,000.00	1,000.00	1,000.00	1,000.00	1,000.00	1,000.00	1,000.00	10,000.00
Oak Management	1,000.00	1,000.00	1,000.00	1,000.00	1,000.00	1,000.00	1,000.00	1,000.00	1,000.00	1,000.00	10,000.00
Pearla Cinema	1,000.00	1,000.00	1,000.00	1,000.00	1,000.00	1,000.00	1,000.00	1,000.00	1,000.00	1,000.00	10,000.00
Total	4,000.00	4,000.00	4,000.00	4,000.00	4,000.00	4,000.00	4,000.00	4,000.00	4,000.00	4,000.00	40,000.00

Collections Report
As of 12/31/92
Green Systems, Inc.

Customer	Invoice	Issued	Due	Balance Due
New Line Computers Mr. Ridge Ewers (309) 676-9896 ext 124	1825	9/2/92	10/17/92	1,000.76
Total New Line Computers				1,000.76
Oak Management Mr. John Driscoll (309) 673-7097 ext 234	1886	10/5/92	12/4/92	810.92
	2001	10/12/92	11/26/92	57.75
Total Oak Management				868.67
Pearla Cinema Mr. Garry Paswellz (309) 673-9856 ext	1841	9/17/92	11/16/92	6,435.89
Green Systems, Inc.-Receivables				

Esc-Create Ctrl-R Memorize F1-Help Ctrl-P Print

QuickBooks proven 12 times easier than leading products.

An independent research firm had small business bookkeepers perform 11 of the most common bookkeeping tasks using

QuickBooks, DacEasy, and Pacioli. People using QuickBooks were able to complete all 11 tasks 12 times more often than people using DacEasy. No one using Pacioli was able to complete all of the tasks.

QuickBooks DacEasy Pacioli

Source: Merrill Research & Associates

Complete financial picture of your business.

Get control over your bottom line.

Evaluate your financial resources.

See emerging sales trends.

Predict your cash needs.

Profit & Loss
1/1/93 12/31/92

Balance Sheet
1/1/93 12/31/92

Sales Report
1/1/93 12/31/92

Cash Flow Forecast
1/1/93 12/31/92

Complete Financial Reports

- Profit and loss statement
- Sales report
- Accounts receivable aging
- Collections report
- Accounts payable aging
- Sales tax report
- 1099 report
- Cash flow forecast
- Payroll report
- Budget report
- Other reports
 - Summary report
 - Transaction report
 - Itemized income and expenses
 - Project or Job report

Works with QuickPay for payroll.

With QuickPay, QuickBooks calculates all deductions, prints payroll checks and keeps complete records.



Special offers for Quicken users!

QuickBooks reads your Quicken files during set-up. And if you act now, you'll get a **\$30.00 rebate** when you buy QuickBooks from your local retailer. (Rebate coupon and redemption instructions are in the package.) Or, buy QuickBooks direct from Intuit for \$54.95. **QuickPay users:** when ordering, tell us you use QuickPay or send in the QuickPay card in the QuickBooks package.

QuickBooks limited time offer

\$99.95

Save \$40.00

\$139.95 Suggested Retail Price

Or buy QuickBooks & QuickPay for \$129.95

\$169.95 Suggested Retail Price

Full 60 day money back guarantee. Rebate offer only valid through retail stores. All offers expire June 30, 1992.

To order, call toll-free

1-800-624-8742

24 hours a day, 7 days a week, U.S. and Canada

Intuit

P.O. Box 3014, Menlo Park, CA 94026

Flexible invoice printing - 3 invoice formats.

Printing options:

- Your letterhead
- Plain paper
- Pre-printed form

Invoice formats:

- Product
- Professional
- Service



© Intuit 1992

Ad Code: BY6TB

COVER STORY Managing InfoGlut

State of the Art, page 244
Solutions Focus, page 290
BYTE Lab
Product Report, page 306

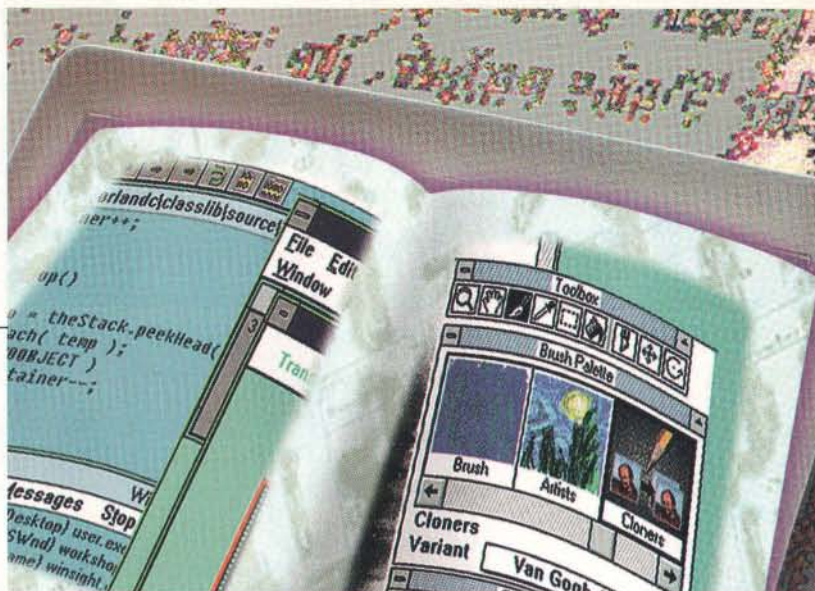

NEWS

- 25 MICROBYTES**
Nutek continues to work on a computer that will run mainstream applications for the Mac under Motif.
- 48 FIRST IMPRESSIONS**
The Best of Comdex/Spring
BYTE's picks from an especially exciting Comdex.
- 53 A 66-MHz Executive Jet**
A 66-MHz processor plus a local bus equals power.
- 58 PaperWorks, paper becomes a computer interface**
NewWave 4.0, a robust Windows desktop and environment package
FrameMaker for Windows, maximum desktop publishing power comes to PCs
Procomm Plus for Windows, a Windows version of the venerable communications program
TCNS, a network from Thomas-Conrad that doesn't compromise speed
Picture Publisher 3.0, Windows image enhancement gets polished
- 78 WHAT'S NEW**
The NEC UltraLite SL/25C travels with active-matrix color; the WindStation lets you watch the weather at your computer; chemVision converts structured chemical data into 3-D models; and more.

FEATURES

- 121 The 1992 Readers' Choice Awards**
BYTE readers name their top products.
- 131 Practical Desktop Video, Part 3: Winning Graphics**
In this installment, you'll learn how to build attention-grabbing graphics into your desktop videos.
- 145 OOPS via DDE**
The DDE approach eases entry into the OOPS world in a controlled manner.



STATE OF THE ART

- 244 MANAGING INFOGLUT**
Overview: Making Knowledge Pay
How to mine the knowledge scattered throughout an organization.
- 257 The New Age of Documents**
Establish a viable document-interchange strategy.
- 263 Electronic Books**
They're coming soon to a computer near you.
- 271 Search and Retrieval**
New methods for managing large document-retrieval systems.
- 279 SGML Frees Information**
Standard Generalized Markup Language helps you turn mounds of documents into information that can boost your productivity and innovation.
- 287 Resource Guide: Search and Retrieval Systems**



290 SOLUTIONS FOCUS
Searching for Common Threads
 Ten text management packages help you organize your files.

306 BYTE Lab Product Report: Writing in Style
 WYSIWYG word processors give your text visual appeal.

316 Color at a Reasonable Price
 The BYTE Lab tests seven color PostScript printers for PCs and Macs.

327 Looking for Answers? Ask Muse
 Occam's Muse makes it easier for Mac users to find answers in mountains of data.

331 Database Publishing with Style
 Ventura DataBase Publisher and PageAhead apply desktop publishing polish to database reports.

336 Two Tools of the QuickTime Trade
 SuperMac's VideoSpigot and Adobe's Premiere help you create digital movies easily.

339 RLN Spells Long-Distance Ethernet
 RLN extends Ethernet connections across phone lines.

342 REVIEWER'S NOTEBOOK
 S3's 86C911 GUI accelerator, and a new MicroPhone for the Mac.



Tektronix Phaser II Pxi

HANDS ON

347 UNDER THE HOOD
How Scanners Work
 New techniques make color scanning better and more affordable.

351 SOME ASSEMBLY REQUIRED
It's a Multithreaded World, Part 2
 Multithreaded operating systems are taking over. Are your applications ready?

357 SOFTWARE CORNER
On-the-Fly Disk Compression
 Diet Disk compression utility, automated Apple Menus, and organizing Usenet news.

359 BEYOND DOS
Windows NT and OS/2 Compared
by Barry Nance
 Windows NT and OS/2 2.0 have a lot in common.

364 ASK BYTE
 Relieving eyestrain, the best writers' tools, keyboard latency, and other problems.

101 USER'S COLUMN
The Mac Goes to School
by Jerry Pournelle
 Jerry sends a computer to college.

344 BOOK AND CD-ROM REVIEWS
The Importance of Being Singular
 War and the intelligent machine, and other selections.

426 STOP BIT
Reflections on the "Privacy" Question
 William F. Buckley Jr. asks, Who should have access to your electronic medical records?

16 EDITORIAL
 Managing Infoglut

20 LETTERS
 BYTE's "subliminal" cover, multimedia critique, and more.

READER SERVICE

422 Editorial Index by Company
 419 Alphabetical Index to Advertisers
 420 Index to Advertisers by Product Category
 Inquiry Reply Cards: 418A

PROGRAM LISTINGS

From BIX: Join "listings/frombyte92"
 From Demolink: See ad on page 423
 On disk: See ad on page 230

INSIDE BYTE

WINDOWS

SPECIAL REPORT

- Windows Windows, Everywhere 155
- Windows Meets the Pen 159
- Flying Windows 172
- A Few of Our Favorite Things 188
- EIS Moves to the Desktop 206
- Image Magic 219
- Ask Dr. Windows 232

INTERNATIONAL SECTION begins after page 100

BYTE (ISSN 0360-5280/92) is published monthly with an additional issue in October by McGraw-Hill, Inc. U.S. subscriber rate \$29.95 per year. In Canada and Mexico, \$34.95 per year. European surface mail subscriptions \$50, airmail \$70. Non-European subscriptions, \$50 surface mail or \$75 airmail. All foreign subscriptions are payable in U.S. funds that can be drawn on a U.S. bank. Single copies \$3.50 in the U.S., \$4.50 in Canada. Executive, Editorial, Circulation, and Advertising Offices: One Phoenix Mill Lane, Peterborough, NH 03458. Second-class postage paid at Peterborough, NH, and additional mailing offices. Postage paid at Winnipeg, Manitoba. Registration number 9321. Printed in the United States of America. **Postmaster:** Send address changes, USPS Form 3579, and fulfillment questions to BYTE Subscriptions, P.O. Box 552, Hightstown, NJ 08520.

BYTE Topic Index and Author Guide

This index helps you find articles that contain information on each of the listed topics. (The topic list changes each month.) Combined with the table of contents (page 4) and the Editorial Index by Company (page 422), you can identify articles by type, subject, title, author, or product discussed.

ACCELERATOR BOARDS

172

AWARDS

48, 121

BUSINESS

78

C++

100IS-20

CD-ROM

344, 100IS-7

CHIP TECHNOLOGY

53

COMMUNICATIONS

58, 188

COMPRESSION

25, 357

DATABASES

327, 331, 426

DDE

145

DESKTOP PUBLISHING

58, 306, 331, 100IS-7

DISPLAYS/MONITORS

364, 100IS-23

DOCUMENT MANAGERS

244, 257, 263, 271, 279, 290

E-MAIL/FAX/MODEMS

58, 78, 342, 100IS-18

ETHERNET/NETWORKS

25, 58, 78, 339, 342

EXECUTIVE INFORMATION SYSTEMS

206

FREWARE

357

GRAPHICS

58, 172, 188, 336, 364

GUIs

58

HEALTH

364

HYPertext

263

INDEXING

287, 100IS-56

INFORMATION ACCESS

244

KEYBOARDS

364

LAPTOPS/NOTEBOOKS/PORTABLES

78, 100IS-3, 100IS-23

MACINTOSH

25, 48, 101, 327, 336, 357

MULTIMEDIA

78, 131, 336

MULTITASKING

351

NATURAL LANGUAGE

327

OS/2

351, 359

PCMCIA

364, 100IS-3

PEN PC

25, 159

PERIPHERALS

347

POSTSCRIPT

257

PRINTERS

316, 364

PRIVACY

426

PROGRAMMING

78, 145, 232, 351, 357, 100IS-20

SCANNERS

347

SCIENCE

78

SEARCH

271, 287, 290, 100IS-56

SPARC

100IS-43

TELECOMMUNICATIONS

342

TEXT

244, 257, 263, 271, 279, 287, 100IS-56

386SX

100IS-23

TRANSLATION

364

TUTORIAL

344

UNIX

25, 357

UTILITIES

188, 357

VOICE

364

WINDOWS

58, 101, 306, 331

WORD PROCESSING

306, 364

WORKSTATIONS

100IS-43

AUTHORS

Alford, Roger C. 347
 Allen, Dennis 16
 Apiki, Steve 188
 Barker, D. 58, 188, 306
 Buckley, William F. Jr. 426
 Busch, Earlene 271
 Cook, Rick 25
 Côté, Raymond GA 188, 290
 Crabb, Don 327
 DeRose, Steven J. 263
 Diehl, Stanford 58, 188, 290, 344
 Donovan, John W. 53
 Edwards, David L. 306
 Eglowstein, Howard 344
 Friedman, Rich 155, 188
 Gilhooly, Kevin 145
 Hudes, Dana 219
 Joch, Alan 188
 Jones, Graham 100IS-7
 Kenner, Hugh 344
 Kinlan, Jim 206
 Kornfeld, Kevin 145
 Koulopoulos, Thomas M. 272
 Lent, Anne Fischer 188
 Linderholm, Owen 25, 58
 Locke, Christopher 244
 Loeb, Larry 100IS-3
 Loveria, Greg 172
 Malloy, Rich 48
 McGeough, Henry 100IS-43
 Miastkowski, Stan 58, 188
 Mitchell, Rob 188
 Nadeau, Michael 121
 Nance, Barry 58, 339, 357, 359
 Northrup, Charles J. 351
 Pountain, Dick 100IS-18
 Pournelle, Jerry 101
 Powell, James E. 331
 Redfern, Andy 100IS-3, 100IS-20
 Reinhardt, Andy 25
 Reynolds, Louis R. 263
 Schnapp, Russ 25
 Sheldon, Kenneth M. 58
 Smith, Ben 357
 Thompson, Tom 25, 316, 336, 344, 357
 Udell, Jon 159, 188
 Ullman, Ellen 25
 Warnock, John E. 257
 Wright, Haviland 279
 Wszola, Stan 232, 306
 Yager, Tom 131, 188

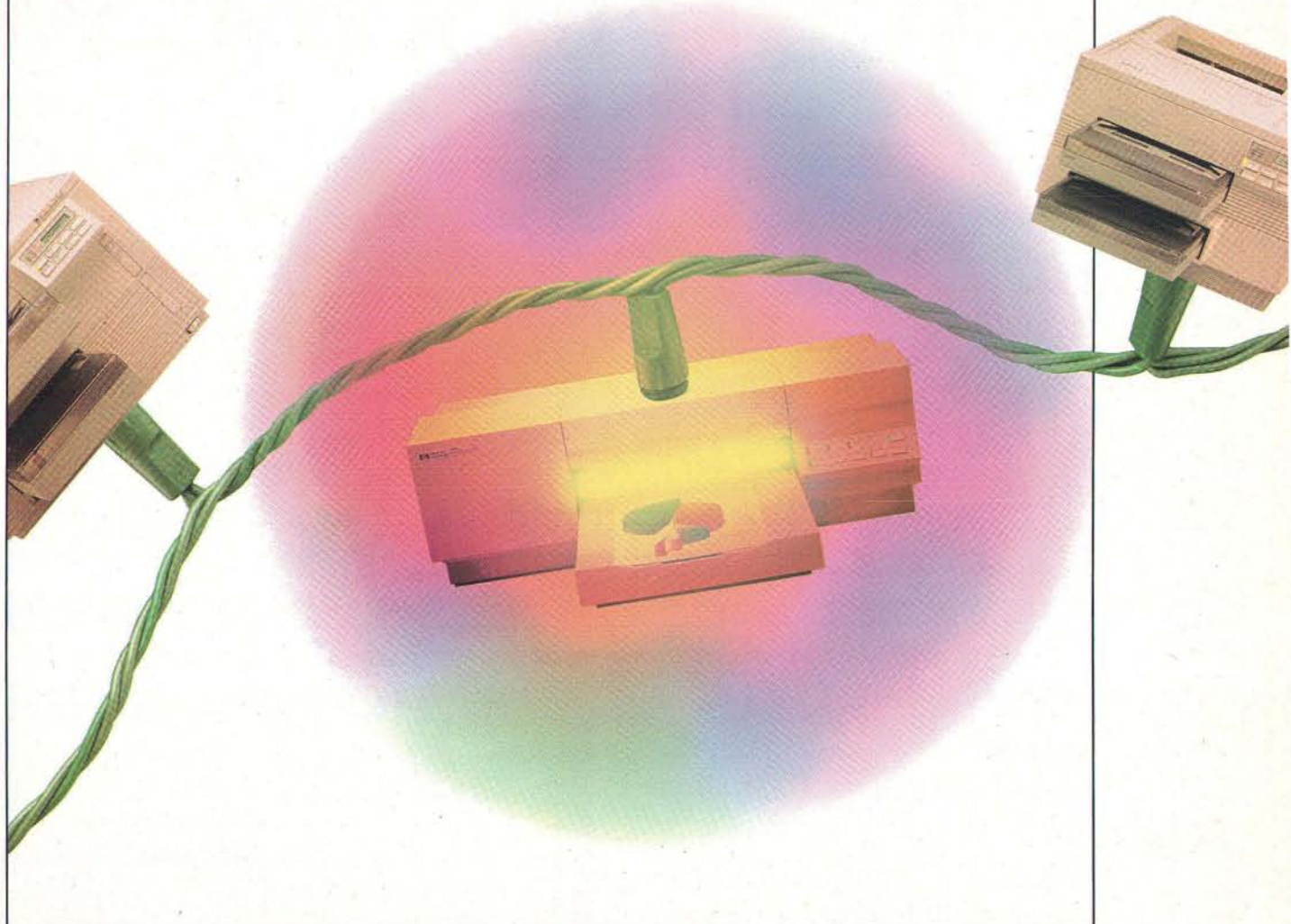

HP's PaintJet XL300. Now, brilliance doesn't require genius to install.

At last. A 300 dpi color printer that's as easy to add to your system as a LaserJet.

Vivid color has never been so simple. The new PaintJet XL300 inkjet printer gives you laser-quality color graphics, text, and the compatibility of HP LaserJet printers. All for the remarkably low price of just \$3,495*.

The PaintJet XL300 has LaserJet compatibility built right in. The same typefaces. The same page formatting. It also has PC/Macintosh auto-switching, so users in a mixed environment can share. And, just like a LaserJet, the PaintJet XL300 becomes network-ready with optional HP JetDirect interface cards.

Get laser-quality printing on a choice of media that includes plain paper and transparencies. Or add Adobe® PostScript® for access to even more graphics applications.

See how easily the PaintJet XL300 can bring color to your system. Call **1-800-752-0900, Ext. 3158** for a free print sample and the name of the authorized HP dealer nearest you.

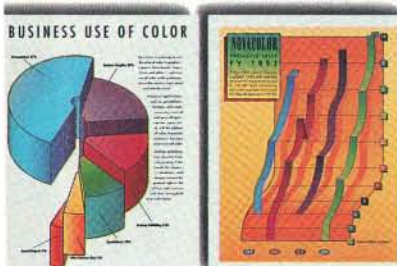

© 1992 Hewlett-Packard Company
*Suggested U.S. list price. Adobe and PostScript are registered trademarks of Adobe Systems, Inc. in the U.S. and other countries. PE12205



Why consider a new you can leave we

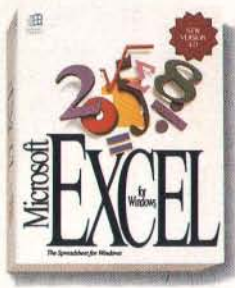

Microsoft Excel 4.0, the spreadsheet for Windows.

Because well enough just might not be good enough anymore.

Because new Microsoft® Excel 4.0 for Windows™ is the ultimate refinement of a powerful, easy-to-use spreadsheet.

Because you could be getting your day-to-day spreadsheet tasks, not to mention more amazing number-crunching feats, done faster. And more easily.

We're talking about one-step just-about-everything here.

Take a feature like Autofor-
mat: with just a click of your mouse, it applies one of 14 sharp-looking, professionally designed formats to your worksheet.

Or consider Autofill, which intelligently helps you build your worksheets. For example, when you type January in a cell, Autofill automatically enters February, March, April—as many (or as few) months ahead as you designate.

Shortcut menus are another innovation. When you click the right mouse button, a menu appears on-screen next to whatever you're doing, offering you all the options that sensibly relate to the task at hand.

Wizards are step-by-step guides that take you through complex tasks, like charting, or creat-



The Scenario Manager is a powerful analysis tool that lets you easily create and save multiple "what if" scenarios, then instantly produce nice-looking summary reports. (Which makes you look nice, too.)

ing summary tables from a database, with incredible ease.

And with new Drag and Drop, all you do is highlight the area you want to move, "grab" it with your cursor, and drag and

spreadsheet when it's enough alone?

drop it to wherever you want it on your screen. It's that simple.

We've also made the Toolbar customizable. Plus, it has handy new features, such as a Spelling Checker and AutoCenter, which lets you center text over multiple columns with a single click of your mouse.

Invested a lot of time in Lotus®? That's no problem. You can learn using what you know. Type in your familiar Lotus 1-2-3® commands, and Microsoft Excel shows you the equivalent commands. Easy.

Microsoft Excel also reads and writes your Lotus files. And it runs your macros—unmodified. It even comes with a convenient 90-

day money-back guarantee.*

By now, you may agree with us that new Microsoft Excel 4.0

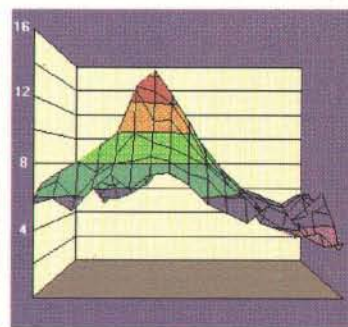
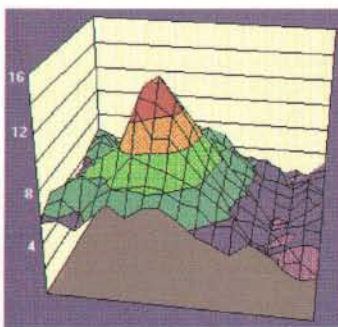
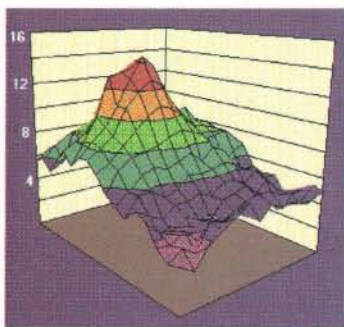

The gallery of 90 chart types includes rotating 3-D charts, along with surface, radar and picture charts. It looks great here. It's even more impressive on your screen.

for Windows is the ultimate refinement of one-step-power-with-ease.

Wondering how to upgrade? Check out the caption underneath that guy to your left—if you're interested in the best spreadsheet

on the planet, that is. Otherwise, just try to forget you ever saw this.

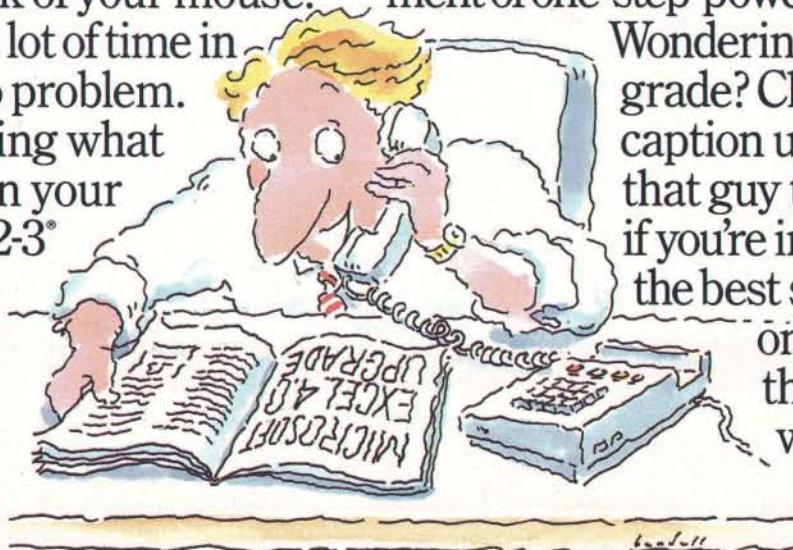

Even upgrading is easy. It's \$99 for current Microsoft Excel users, and \$129 if you're using Lotus 1-2-3 or Borland® Quattro® Pro! Call us at (800) 323-3577, Dept. Y61, to order yours. Or see your local software reseller.

Microsoft
Making it easier

BYTE

EDITOR IN CHIEF
Dennis Allen

EXECUTIVE EDITORS

New York: Rich Malloy
Peterborough: Rich Friedman

MANAGING EDITOR

Anne Fischer Lent

ASSISTANT MANAGING EDITOR

Lauren A. Stickler

NEWS

New York: News Editor: Ed Perratore
Peterborough:

Sr. Ed., *New Products*: Stan Miastkowski
News Editors, What's New: Martha Hicks, Carol Swartz, Amanda Waterfield
Microbytes: David L. Andrews
News Assistant: June Sheldon
San Francisco/West Coast:
Bureau Chief: Andrew Reinhardt
Sr. News Editor: Owen Linderholm
News Editor: Patrick Waurzyniak
Editorial Assistant: Barbara J. Caravello
UK/Europe: Bureau Chief: Andrew Redfern

BYTE LAB

Senior Editor & Director: Alan Joch
Technical Director: Rick Grehan

Technical Editors:

Stephen Apiki: *systems, networking*

D. Barker: *applications software*

Stanford Diehl: *graphics software, add-ins, peripherals*

Tom Yager: *multimedia, Unix, operating systems, software development*

Testing Editors/Engineers: Raymond GA Côté, Howard Eglowstein, Ben Smith, Stanley Wszola

Lab Assistant: Selinda Chiquoine

STATE OF THE ART/FEATURES

Senior Editor: Michael Nadeau
Technical Editors: Janet J. Barron, John W. Donovan, Robert M. Ryan

SENIOR TECHNICAL EDITORS

At Large: Tom Thompson, Jon Udell
Columns: Rob Mitchell
Special Projects: Gene Smarte

ASSOCIATE TECHNICAL EDITORS

Ellen Bingham, Susan Colwell, Jeff Edmonds, Tom Kevan, Cathy Kingery, Margaret A. Richard, Warren Williamson

SENIOR CONTRIBUTING EDITOR

Jerry Pournelle

CONTRIBUTING EDITORS

Hugh Kenner, Barry Nance

CONSULTING EDITORS

Roger C. Alford, Jonathan Amsterdam, Nicholas Baran, Don Crabb, David Fiedler, Laurence H. Loeb, Trevor Marshall, Mark J. Minasi, Dick Pountain, Wayne Rash Jr., Kenneth M. Sheldon, Jane Morrill Tazelaar, Ellen Ullman, Peter Wayner

EDITORIAL ASSISTANTS

Office Manager: Peggy Dunham
Assistants: Linda C. Ryan, Janet A. Young

DESIGN

Director: Nancy Rice
Associate Director: Joseph A. Gallagher
Designer: Jan Muller
Designer: Rebecca Magill
Graphic Designer: Marilyn Fletcher

PRODUCTION AND FINANCE

Director: Claudia Flowers

PRODUCTION

Director: David M. Cohen
Production Manager: David R. Anderson
Senior Editorial Production Coordinator: Virginia Reardon
Editorial Production Coordinator: Barbara Busenbark

Systems Manager: Sherry Fiske
Applications Manager: Donna Sweeney
Typesetter: Christa Patterson

Creative Services Mgr: Susan Kingsbury

Production Artist: Lillian J. Wise

Advertising Services Manager: Linda Fluhr

Senior Advertising Services Representative: Lyda Clark

Advertising Services Representatives:

Dale J. Christensen

Karen Cilley

Rod Holden

Advertising Services Assistant: Roxanne Hollenbeck

Quality Control Manager: Wai-Chiu Li

Operations Assistant: Christine Tourgeau

FINANCE

Business Manager: Kenneth A. King
Assistants: Marilyn Parker, Diane Henry, JoAnn Walter, Jeanne Gatcombe, Jaime Huber, Agnes Perry

MARKETING AND PLANNING

Director: L. Bradley Browne
Administrative Assistant: Carol Cochran
Marketing Communications Manager: Pamela Petrakos

Public Relations Mgr: Dawn Matthews

Asst. Promotion Manager: Lisa Jo Steiner

Marketing Art Dir.: Stephanie Warnesky

Associate Art Director: Sharon Price

Market Research Manager: Julie Perron

Copyrights Manager: Faith Kluntz

Reader Service: Cynthia Sands

Marketing Assistant: Carol Sanchioni

CIRCULATION

Director: Glyn Standen
Subscriptions Manager: Paul Ruess
Assistant Manager: Pam Wilder
Subscriptions Assistant: Holly Zilling
Newsstand Manager: Vicki Weston
Assistant Manager: Karen Desroches
Back Issues: Louise Menegus
Direct Accounts Coordinator: Ellen Dunbar

PUBLISHER

Ronald W. Evans

Publisher's Assistant: Donna Nordlund

ADVERTISING SALES

National Sales Manager:
Jennifer L. Bartel (214) 701-8496

NEW ENGLAND

Michael Lamattina (617) 860-6344

EAST COAST

Kim Norris (212) 512-2645
Ariane Casey (212) 512-2368

SOUTHEAST

John Schillin (404) 843-4782

MIDWEST

Kurt Kelley (312) 616-3328

SOUTHWEST, ROCKY MOUNTAIN

Jennifer Walker (214) 701-8496

SOUTH PACIFIC

Beth Dudas (714) 753-8140
Alan El Faye (213) 480-5243

NORTH PACIFIC

Bill McAfee (408) 879-0381
Roy J. Kops (415) 954-9728
Leslie Hupp (415) 954-9705

INSIDE ADVERTISING SALES

Director: Liz Coyman (603) 924-2518
Assts.: Susan Monkton, Vivian Bernier

NATIONAL ADVERTISING SALES

Mary Ann Goulding (603) 924-2664
Patricia Payne (603) 924-2654
Jon Sawyer (603) 924-2665
Barry Echavarría (603) 924-2574

THE BUYER'S MART (1x2)

Joseph Mabe (603) 924-2656

HARDWARE/SOFTWARE SHOWCASE

Ellen Perham (603) 924-2598
Mark Stone (603) 924-2695

REGIONAL ADVERTISING SECTIONS

Brian Higgins (603) 924-2651
Barry Echavarría (603) 924-2574
Larry Levine (603) 924-2637

BYTE DECK

Ed Ware (603) 924-2596

EURO-DECK

James Bail (603) 924-2533

INTERNATIONAL ADVERTISING SALES STAFF

See listing on page 421.

PERSONNEL

Human Resources Admin.: Patricia Burke
Assistant: Fran Wozniak
Receptionist: Beverly Goss

HOW TO CONTACT THE EDITORS

We welcome your questions, comments, complaints, kudos, and submissions.

MAIN OFFICE: One Phoenix Mill Lane, Peterborough, NH 03458, (603) 924-9281.

WEST COAST: 425 Battery St., San Francisco, CA 94111, (415) 954-9718; 15635 Alton Pkwy., Suite 290, Irvine, CA 92718, (714) 753-8140.

NEW YORK: 1221 Avenue of the Americas, New York, NY 10020, (212) 512-3175.
UK/EUROPE: Wimbledon Bridge House, One Hartfield Rd., Wimbledon, London SW19 3RU, England, 011-44-81-543-1234.

ELECTRONIC MAIL: On BIX, send to "editors." All BYTE editors and columnists also have individual mailboxes on BIX for easy access.

MCI: 250-0135 BYTE Magazine. Many editors also have individual MCI addresses in their own name.

OTHERS: Many editors also are reachable through uunet, AppleLink, CompuServe, and numerous other services.

U.S. fax: Editorial: (603) 924-2550

Advertising: (603) 924-7507

U.K. fax: 011-44-81-540-3833

SUBMISSIONS

Authors: We welcome article proposals and submissions. Unacceptable manuscripts will be returned if accompanied by sufficient return postage. Not responsible for lost manuscripts or photos.

Vendors: We welcome news of your new products; please call the News department or the BYTE Lab at the earliest possible date. We cannot be responsible for unsolicited product samples.

SUBSCRIPTION CUSTOMER SERVICE

Inside U.S. (800) 232-BYTE; outside U.S. (609) 426-7676. For a new subscription—(800) 257-9402 U.S. only, or write to BYTE Subscription Dept., P.O. Box 555, Hightstown, NJ 08520. Subscriptions are \$29.95 for one year, \$54.95 for two years, and \$74.95 for three years in the U.S. and its possessions. In Canada and Mexico, \$34.95 for one year, \$64.95 for two years, \$87.95 for three years. In Europe, £29 (U.S. \$50) for fast surface delivery, £41 (U.S. \$70) for air delivery. Non-European countries U.S. \$50 for surface mail, or U.S. \$75 for air mail. Single copy price is \$3.50 in the U.S. and its possessions, \$4.50 in Canada. Foreign subscriptions and sales should be remitted in U.S. funds drawn on a U.S. bank. Please allow six to eight weeks for delivery of first issue.

PHOTOCOPY PERMISSION:

Where necessary, permission is granted by the copyright owner for those registered with the Copyright Clearance Center (CCC), 27 Congress St., Salem, MA 01970, to photocopy any article herein for personal or internal reference use only for the flat fee of \$1.50 per copy of the article or any part thereof. Correspondence and payment should be sent directly to the CCC, 27 Congress St., Salem, MA 01970. Specify ISSN 0360-5280/92, \$1.50. Copying done for other than personal or internal reference use without the permission of McGraw-Hill, Inc., is prohibited. Requests for special permission or bulk orders should be addressed to the publisher. BYTE is available in microform from University Microfilms International, 300 North Zeeb Rd., Dept. PR, Ann Arbor, MI 48106, or 18 Bedford Row, Dept. PR, London WC1R 4EJ, U.K.

Copyright © 1992 by McGraw-Hill, Inc. All rights reserved. BYTE and BIX are registered trademarks of McGraw-Hill, Inc. Trademark registered in the United States Patent and Trademark Office.

Member
Audit Bureau of Circulation

BIX INTERACTIVE ON-LINE SERVICE

DIRECTOR OF COMPUTER-RELATED SERVICES

Stephen M. Laliberte

SENIOR EDITOR ON-LINE SERVICES

Anthony J. Lockwood

MEMBER SERVICES MANAGER

Kevin Plankey

EXCHANGE EDITORS

Amiga Exchange: Joan Dow
Entertainment and Leisure Exchange: Rich Taylor
IBM Exchange: Barry Nance
Programmers Exchange: Bill Nicholls
Professionals Exchange: David Reed
Tojerry Exchange: Jerry Pournelle
Writers Exchange: Wayne Rash Jr.

BIX, owned and operated by General Videotex Corporation, is a worldwide, low-cost, on-line information service featuring industry news, downloadable software, powerful electronic mail, previews of upcoming BYTE articles, the full text of published issues of BYTE, and source and/or executable code for BYTE benchmarks and noncommercial software mentioned in feature articles. BIX also offers unmatched "conferences" on virtually every computer-related topic imaginable, where you can share information with thousands of other computer pros. To subscribe via modem, set your communications software to full duplex, 7 bits, even parity, 1 stop bit, and then call 800-225-4129; in MA, call (617) 861-9767. International, call NUI310690157800. Then hit the Enter/Return key and enter "BIX" when asked to log in; then enter "BIX.BYTE" when asked for a name. For current fees and more information, call (800) 695-4775 or (617) 354-4137 on voice phone; fax: (617) 491-6642.

OFFICERS OF MCGRAW-HILL, INC.:

Chairman, President and Chief Executive Officer: Joseph L. Dionne, Executive Vice President, General Counsel and Secretary: Robert N. Landes, Executive Vice President—Operations: Harold W. McGraw III, Senior Vice President, Treasury Operations: Frank D. Penglase, Executive Vice President and Chief Financial Officer: Robert J. Bahash, Executive Vice President, Administration: Thomas J. Sullivan, Senior Vice President, Corporate Affairs, and Executive Assistant to the Chairman: Mary A. Cooper, Senior Vice President, Editorial: Ralph R. Schulz.

Founder: James H. McGraw (1860–1948).

Upgradable. Low Cost.

Hot New ZEOS '386 and '486 systems!

PC Magazine calls it "the ultimate-power desktop PC." What will you call your new *ZEOS '486 Editors' Choice* system? Probably the hottest computer you've ever owned!

First of all, our prices are great! For starters, you can get a ZEOS 386-33 upgradable for as little as \$1,395. Or you can move right into a *complete 486DX-50MHz for only \$1,995*. Outrageous! And it's not just the price. It's all the extras we give you, too.

As an example, your new ZEOS Windows system comes complete with your choice of two Windows applications: *Lotus 1-2-3 for Windows*, *Ami Pro 2.0* and *Freelance Graphics for Windows*. With a suggested retail of over \$1,000, even at "street prices" that's a *great* value. It's ZEOS value. Here's another great value example.

You have probably heard about the importance of protecting your new computer

investment with a surge suppressor. Well, your new ZEOS upgradable desktop system already has one. *Built into the power supply!* We didn't stop there either.

Because you're also getting *24-Hour-a-Day Toll-Free Technical Support*. While most of the others still only offer part-time technical support, as a ZEOS customer, you get around-the-clock 24-hour-a-day support, 365 days a year. Any time you need help, all you have to do is pick up the phone and give us a call, *any time* of the day or night!

And all of this is just for starters. Because when you turn the page we're going to talk about other exciting and important reasons for you to buy from

ZEOS. Like 486SX-25s, the new 486DX-50s, your ZEOS *Editors' Choice '486 and more.*

Come on in!



386DX2-50 and 486DX-50s!

right on the motherboard... along with the serial and parallel ports, too. The result? Two slots are saved, giving you a total of *eight*. Now, that's expandability.

A LOT OF COMPUTER FOR A LITTLE CASH.

Your new ZEOS upgradable system is not only expandable, it's loaded with features. Like our 300 watt power supply — *now with built-in surge suppression* — plus twin cooling fans for even more reliability and our unique SpaceSaver case. And every ZEOS system (not just the power supply) is UL® listed.

Plus, for a limited time, your new ZEOS Windows system comes complete with your choice of two out of three Windows applications: *Lotus 1-2-3 for Windows*, *Ami Pro 2.0*, and *Freelance Graphics*. These aren't trial copies — they're the complete, fully documented retail packages. And with a suggested retail price of over \$1,000, even at street prices that's a great value.

In addition to providing you with top quality products, we're committed to after-the-sale support as well. All ZEOS systems are covered by our 30-Day Absolute Satisfaction Money-Back Guarantee — and our One Full Year Limited Warranty. And you can call us Toll Free at 800-423-5891, 24 hours a day, with any questions you may have. We're here for you.

YOU SIMPLY CAN'T GO WRONG.

Your new high-performance ZEOS upgradable comes from a family of systems which have received *nine PC Magazine Editors' Choice Awards*. And don't forget, for a limited time only, when you purchase any new ZEOS Windows system, you'll also receive your choice of *two*: *Lotus 1-2-3 for Windows*, *Ami Pro 2.0*, and *Freelance Graphics*.

So give us a call,
800-423-5891.

Prices and specifications are subject to change without notice. Please call for current information. The following are trademarks of their respective companies: Lotus 1-2-3, Freelance Graphics and Ami Pro of Lotus Development Corporation; Windows and Microsoft of Microsoft Corporation; Z-Card, SpaceSaver and ZEOS of ZEOS International, Ltd.; © 1992, ZEOS International Ltd., 530 5th Avenue N.W., St. Paul, MN 55112, USA. ZEOS is a publicly traded company (NASDAQ symbol: ZEOS). 9EC4P-2/16



ZEOS PRESENTS UPGRADABLES FEATURING 4MB MEMORY, 130MB DRIVE AND MORE!

128K cache Available!

- The processor and speed of your choice plus future upgradability.
- 4 full MB ultra-high-speed RAM.
- Our fast 130MB IDE hard drive with built-in cache.
- Both Teac® 1.2MB and 1.44MB floppy disk drives.
- Incredible Diamond Stealth VGA graphics card with 1MB RAM, Sierra DAC and WinRIX drawing software. Capable of over 32,000 colors!
- ZEOS 14" high-res 1024x768 non-interlaced VGA color monitor with tilt & swivel base.
- Shadow RAM and EMS support.
- ZEOS 101-key SpaceSaver keyboard.
- Two serial, one parallel and one game port built right on the motherboard.
- 7-16, 1-8 bit expansion slots; 80387 math coprocessor support (for '386 systems).
- ZEOS 7-bay SpaceSaver case with two cooling fans for added reliability and product life.
- High-quality 300 watt power supply with built-in surge suppression.
- Microsoft Windows 3.1, Microsoft Mouse, DOS 5.0 and now pick 2: Lotus 1-2-3 for Windows, Ami Pro 2.0, and Freelance Graphics!
- Includes ZEOS 24-Hour-a-Day Technical Support and complete Customer Satisfaction Package.

PICK YOUR POWER

386DX-33	\$2395
486SX-20	\$2495
486SX-25	\$2595
486DX-33	\$2695
486DX2-50	\$2895
486DX-50	\$2995

Plenty of Options:

Including additional memory, an incredible selection of hard drives and virtually any other add-on you could want. Ask about other special money-saving packages, too.

**ORDER NOW TOLL FREE
800-423-5891**

Fax Orders: 612-633-1325
Gov't Orders: 800-245-2449
GSA #GS00K91AG55176
Outside U.S. and Canada:
612-633-6131

Hearing Impaired (TDD):
800-228-5389

Terms of Payment:

MasterCard, VISA, Discover, Am Exp,
Z-CARD™, COD and Leasing programs.
Open 24 Hours a Day,
365 Days a Year!



ZEOS[®] Upgradables!

Announcing New 486SX-25, 486DX2-50, and 486DX-50



THREE HOT NEW PROCESSOR OPTIONS!

No matter how much power you're looking for, ZEOS has it for you. We've just added three of the fastest, most powerful new processors to our line of upgradables—the 486SX-25, the 486DX2-50 and the full-blown 486DX-50. ZEOS power like never before!

Start with our 386DX-33 workhorse for true desktop power computing. Or, if it's a '486 you want, check out our 486SX-20 or -25. The 486SX is like a 486DX without the built-in math coprocessor. It's your easiest way to own the '486.



FOR A LIMITED TIME

When you buy any ZEOS Windows system you can choose 2 of 3 Windows applications: Lotus 1-2-3 for Windows, Ami Pro 2.0, and Freelance Graphics for Windows!

But if it's 486DX power you want, go with the quality, performance and value that won *PC Magazine Editors' Choice*. What's more, for the first time, ZEOS gives you the option of 486-50MHz power—with either the ZEOS 486DX2-50 or 486DX-50. *Unbelievable power*. And the price of 50MHz power? That's what you really won't believe; it's not much more than a '486-33. Amazing!

THAT'S JUST FOR STARTERS.

Because whichever processor you choose, you're getting a fully compatible, high-speed upgradable system; one that allows you to move to an even faster processor in the future! Speaking of speed...

We mean *incredible speed*. First we start with the high-speed upgradable processor of your choice with some of the fastest RAM made. Both are placed on a ZEOS-designed system board that is one of the most advanced in the industry. Then we add an incredibly fast IDE hard drive and genuine Teac[®] floppy drives. Plus, we put the ports for these drives

The ZEOS® 486SLC-25. A Price-

Now, you can get '486 performance at a 386SX price. Incredible? Yes. Impossible? No! It's the new ZEOS 486SLC-25 and this baby is *hot*. Now you can have our new super-fast, super-loaded ZEOS 486SLC system at the incredible price of only \$1995. There is absolutely nothing else like it.

And when we say loaded, we mean *loaded!* Your new ZEOS 486SLC comes with our non-interlaced 1024x768 color monitor. A Diamond graphics card offering over 32,000 colors. Your choice of two *complete* Lotus Windows software packages, MS-DOS 5.0, and Windows 3.1. A Microsoft mouse. And much, much more.

To create the ZEOS 486SLC, we started at the heart with a brand-

new microprocessor from Cyrix®. This hot new chip, with its internal pipeline cache, accesses internal memory with a 32-bit bus. You'll see that the 486SLC-25 delivers more bang for the buck than anything else out there.

You may know Cyrix as the folks who design the unbelievably fast and reliable FasMath™ family of math coprocessors which consistently receive industry accolades. Now Cyrix has applied their high performance

design skills to the new 486SLC CPU. And ZEOS makes it scream!

AND HOW DOES IT PERFORM?

We tested it against a typical 386SX-20 and

a 386DX-33. We tested it again against a 486SX-20. The results? Check out these benchmarks! The ZEOS 486SLC performed nearly

'486 Performance at a '386SX Price.

ZEOS® 486SLC-25

You'll get superfast RAM, a 200 watt power supply, and lots of bays and slots for future expansion. The hardware simply can't be beat.

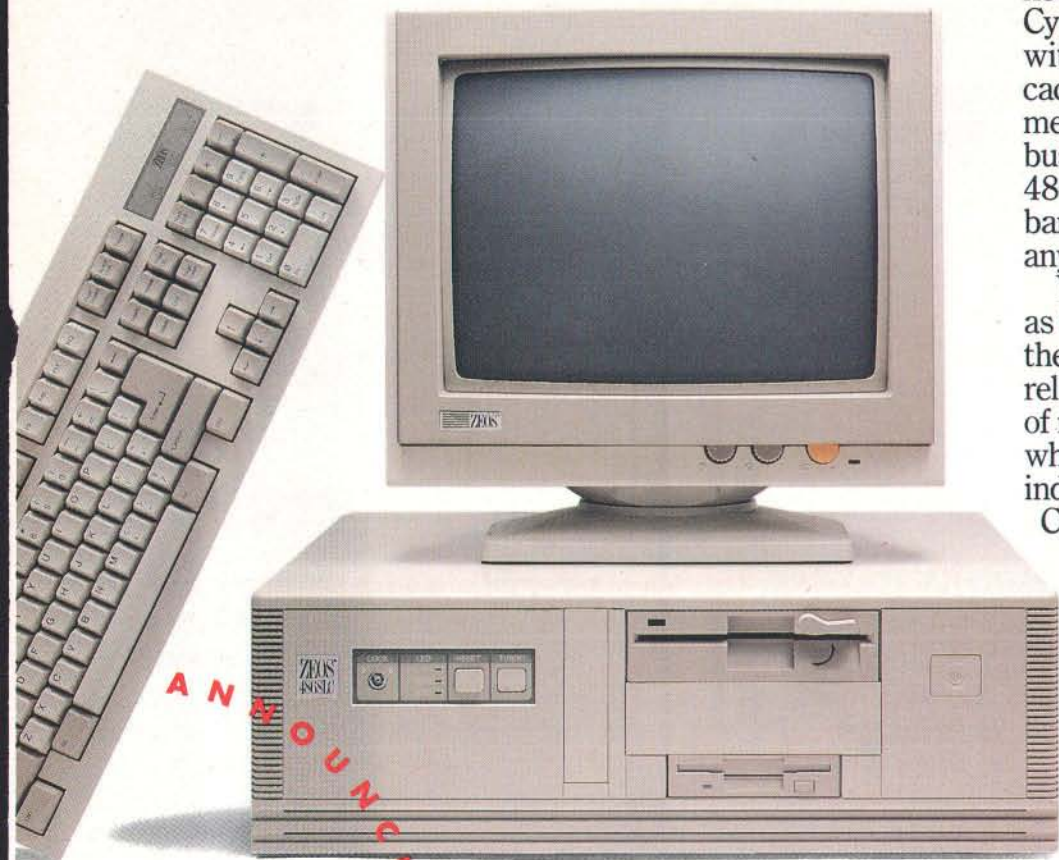

Performance Breakthrough!

twice as fast as a 386SX system, about 1.5 times as fast as a 386DX-33, and it was even faster than a 486SX-20! Now this power is yours at the price of a 386SX.

COMPATIBILITY. 100% GUARANTEED.

This new 486SLC microprocessor is 100% compatible with industry standard software. We're so sure of your satisfaction with the compatibility of your new ZEOS SLC-25 that we're adding *yet another* guarantee to the standard-setting ZEOS warranties and guarantees that back all of our products. We guarantee that during the first six months you own your system, if your ZEOS 486SLC-25 exhibits any

compatibility problems with the top 100 selling software titles, ZEOS will replace that PC with a comparable ZEOS 486SX system. And we'll do it absolutely free.

LOTUS BUNDLE: NO ADDITIONAL CHARGE!

Included with your new 486SLC-25 is your choice of two: *Lotus 1-2-3 for Windows*, *Ami Pro 2.0* and *Freelance Graphics for Windows*.

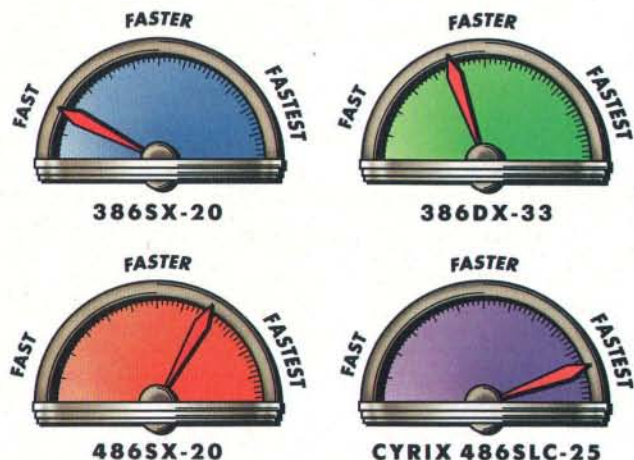

Z • SPEED METER

The Z-Speed Meter reports actual performance differences between these four processor types. Your new 486SLC-25 comes out the winner!

Graphics for Windows. Pick two. Complete and fully-documented—this software is worth close to \$1000 alone! Yours from ZEOS, at no additional charge.

FREE TECHNICAL SUPPORT. 24 HOURS A DAY.

Questions about your new system? Call us. Your new ZEOS system is backed by Toll-Free Technical Support, 24 Hours a Day, 365 Days a Year. Plus a 30-Day Absolute Satisfaction Money-Back Guarantee. *Plus* our Express Parts Replacement Policy. You're going to be very satisfied. We don't just say it. *We guarantee it.*

ORDER YOUR NEW ZEOS 486SLC-25 NOW!

Call us now: 800-423-5891. And get the kind of power you need at the price you want to pay: '486 performance at a 386SX price. Only \$1995! Who could resist? Call ZEOS now!

All prices and specifications are subject to change without notice. Please call for current pricing and warranty details. ZEOS is a publicly traded company, NASDAQ Symbol: ZEOS. © 1992, ZEOS International, Ltd., 530 5th Avenue NW, St. Paul, MN 55112. All products and company names are trademarks or registered trademarks of their respective holders. SLC-1/1



NOW
Pick any
two from
Lotus!

ONLY \$1995!

- 486SLC-25 CPU from Cyrix.
- 4MB high-speed 53ns RAM providing true zero-wait state performance.
- 107MB ultra-fast IDE hard disk drive.
- Teac® 5.25" 1.2MB and 3.5" 1.44MB floppy drives.
- Incredible Diamond SpeedStar Hi-Color VGA graphics card with 1MB RAM and Sierra DAC. Over 32,000 colors!
- ZEOS 14" 1024x768 VGA color monitor with tilt/swivel base. Non-interlaced!
- ZEOS/RS 101-key SpaceSaver keyboard.
- Two serial, one parallel and one game port.
- 7-16, 1-8 bit expansion slots, math coprocessor support.
- Rugged ZEOS 7-bay Space-Saver case. 200 watt power supply and two cooling fans for added reliability and product life.
- Microsoft Mouse!
- MS-DOS 5.0 with QBasic.
- Microsoft Windows 3.1 plus your choice of 2 out of 3 Windows applications: Lotus 1-2-3 for Windows, Ami Pro 2.0 and Freelance Graphics for Windows!
- ZEOS 24-Hour-a-Day Toll-Free Technical Support and complete Customer Satisfaction Package.

Tailor your system...

More memory, an incredible selection of hard drives and virtually any other add-on you could want. Ask about other money-saving packages, too.

ORDER NOW TOLL FREE
800-423-5891

Fax Orders: 612-633-1325
Gov't Orders: 800-245-2449
Outside U.S. and Canada:
612-633-6131

MasterCard, VISA, Discover, Am Ex, Z-Card,™ COD and Leasing Programs.

Open 24 Hours a Day,
365 Days a Year!





DENNIS
ALLEN

EDITORIAL

MANAGING INFOGLUT

You can't afford not to read this issue of *BYTE*, because inside is article after article on one of the biggest stories of the decade. No, it's not about a new chip or a new software engine. This story is about the one thing with which we all must deal; this story is about the very fiber of business. As our cover proclaims, these articles cover the strategies and methods for turning textual information into usable knowledge.

To be competitive in business in the 1990s, you must leverage all the knowledge your company can muster

Just think about all the correspondence, memos, reports, proposals, documentation, and news that's been word processed or otherwise placed into electronic form at your company. Those pieces of text contain the stuff that business is made of. Piece by piece, they exist in a delicate mesh of knowledge that permeates your organization. Yet, for the most part, they go unused because the utter vastness of this information has made it seemingly impossible to manage. But this really isn't the case.

There are ways to get a handle on the information, and there are strategies for the future that you can adopt now. The most competitive companies will be the first to adopt search-and-retrieval software and the first to implement strategies for organizing information for the future. They recognize the need to develop their particular company's knowledge base into a repository of information that anyone within the company can access so that the knowledge is neither hoarded nor misplaced.

I recall a story of lost information for NASA's space shuttle. Several years back, when it became apparent that the space shuttle would need extra heat protection for reentry, the obvious answer was to attach special tiles to the underbelly of the craft. It was obvious because there had been extensive research on the tiles years earlier. But the research data was, at least for a while, lost.

It was not a matter of simply calling an old employee and asking where the files had been placed; many people had been involved in acquiring the information, and they simply couldn't be reached. NASA—with all its computing power—was left in a quandary of not knowing where the information was located and not having the funds to develop the tile information anew.

Your company can easily find itself in a similar situation; maybe it already has. Consider projects that have been halted for one reason or another. What happened to

all the information—the research, reports, and supporting documents—that was accumulated before the project was dismantled? Perhaps it went into the archives, someone's desk drawer, or the shredder.

Or what about that key employee—what happens when he or she leaves the company? They may leave their disk files intact, but unless you know what's in them, or unless the information happens to have been well organized, those files are useless. Imagine when employees leave how many hard disks have been reformatted to reclaim disk space for the next employee while throwing away information that may have taken years to amass.

My bet is that you'll need that information someday, but you may not know that you ever had it. Even if you have the information, not knowing how or where to find it is hardly different from not having the information at all. That's why this issue is a *must* read. To be competitive in the 1990s, you have to leverage all the knowledge your company can muster. My advice is simple: Don't waste a second in exploring ways to manage the vast textual information hidden away in your company.

That's why the *BYTE* staff has pulled together such a strong collection of articles on the subject. From the strategies of organizing information and turning text into usable knowledge to the tactics of search-and-retrieval software and WYSIWYG word processing, it's all here in this issue.

Of course, doing the bigger story had its own challenges—chiefly, how to convey the concept on the cover of the magazine. Frankly, it would have been easier to put a photo of the newest and fastest PC hardware on the cover. To do so, however, would have been to duck what is one of the most important issues in computing today. Yet, you may not see the subject make the cover of other publications.

This is the first time that an in-depth, multi-article report on the subject of turning text into knowledge has been published in the popular press, and it seems only appropriate that it appear on the cover and in the pages of *BYTE*.

—Dennis Allen
Editor in Chief
(BIX name "dallen")

New
version.

Quattro Pro 4.0

“... the best DOS spreadsheet...”

“We make no bones about it—the innovative Quattro® Pro 4.0 is **the best DOS spreadsheet** you can buy.”

Sebastian Rupley, *PC/Computing*, March 1992

“Quattro Pro 4.0: Improvements add up to **the ultimate DOS spreadsheet.**”

Craig Stinson, *PC Magazine*, April 28, 1992

“... version 4.0 is arguably **the best non-Windows spreadsheet** available ...”

John Walkenbach, *PC World*, March 1992

“Borland is hitting on all cylinders with [Quattro Pro 4.0] ...”

Raphael Needleman, *InfoWorld*, January 27, 1992

“Quattro Pro version 4.0 looks like **the best DOS spreadsheet** ever.”

Jim Seymour, *Office Technology Management*, February 1992

“Verdict: **The best DOS spreadsheet** in the world.”

Mark Whitehorn, *PC User (U.K.)*, March 24, 1992



Order now absolutely RISK-FREE. See your dealer today or call 1-800-331-0877, ext. 5653.

B O R L A N D

Software Craftsmanship

Copyright © 1992 Borland International, Inc. All rights reserved. Quattro is a registered trademark of Borland International, Inc. BI 1504

Circle 81 on Inquiry Card (RESELLERS: 82).

THE WORLD'S FIRST OPTICAL HARD DRIVE.

When will optical drives be as fast as hard drives? At Pinnacle, and only Pinnacle, we proudly answer... today! Introducing the PMO-650™, a high speed 650 MB rewritable optical drive featuring Pinnacle's own OHD™ (Optical Hard Drive) mechanism. The PMO-650 works like a hard drive, feels like a hard drive, but it's better - it's optical. And with optical there are many

advantages: removability, reliability, and a lower cost per megabyte of disk storage.

The PMO-650 features the latest advancements in optical technology. Pinnacle's R&D center, located in Colorado Springs, CO, is one of the most advanced optical research and development facilities in the country.

The Pinnacle R&D Center is now the leader in optical drive performance and innovation.

OPTICAL HARD DRIVE

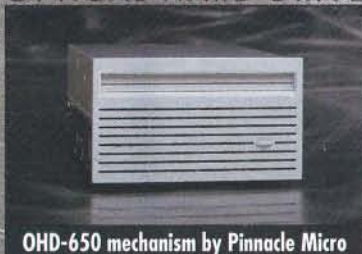

OHD-650 mechanism by Pinnacle Micro

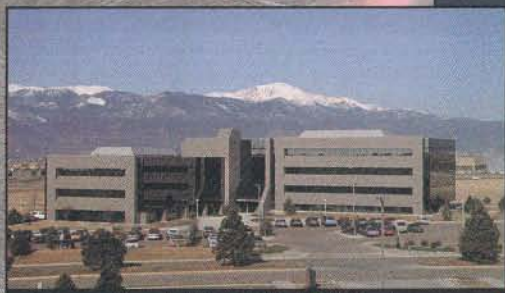

Pinnacle Micro Optical R&D Center



Trademarks and Registered Marks to their respective owners. • XXBench test performed by XXCAL, Inc. 3/92 • *Test Results performed with a 1/3 stroke plus latency over a 50 MB band width. A 1/3 stroke plus latency is the standard of measurement in the optical storage industry.

19 Technology • Irvine, CA 92718 • U.S.A. • (800) 553-7070 • Int'l (714) 727-3300 • Fax (714) 727-1913

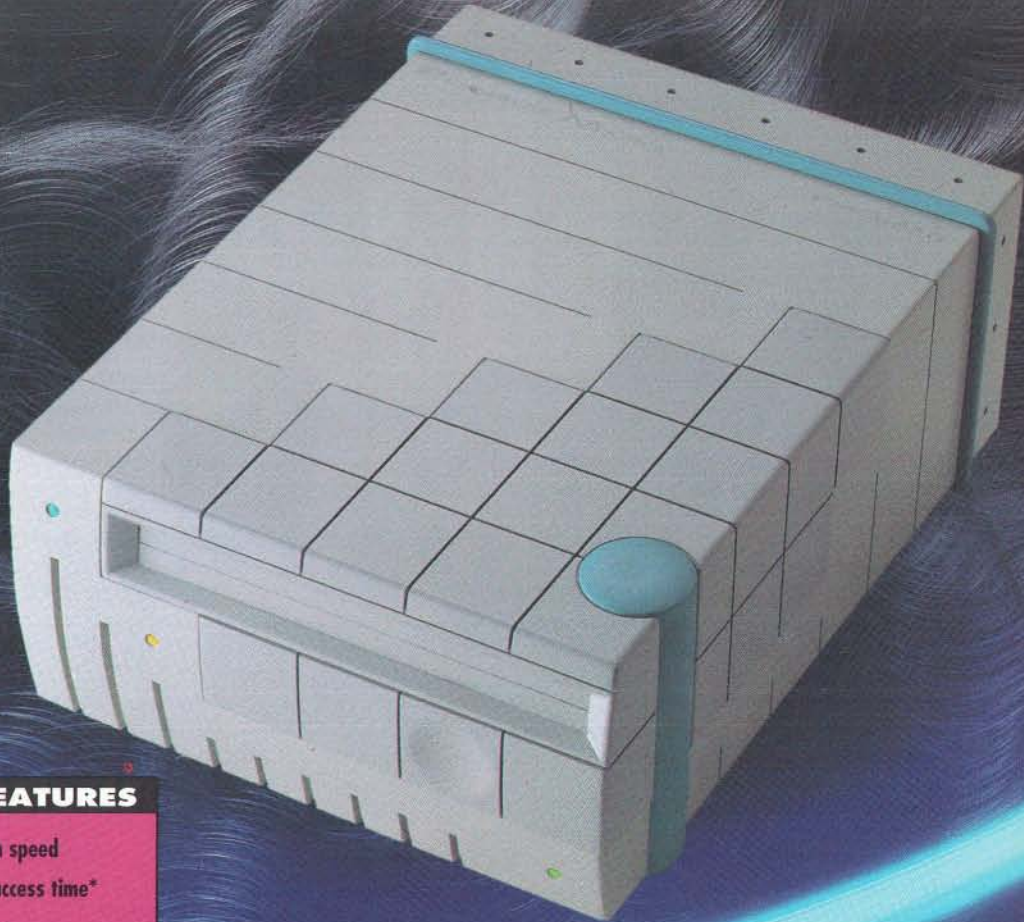

PMO-650 FEATURES

- ◆ 3600 RPM rotation speed
- ◆ 19 msec effective access time*
- ◆ MTBF: 30,000 hours
- ◆ Ultra light optic head
- ◆ Split Optic Design
- ◆ ISO/ANSI Standard compliant
- ◆ Direct seek technology
- ◆ Data queuing on reads/writes
- ◆ 20 MHz processor/design
- ◆ Horizontal and vertical mounting
- ◆ Dust-resistant design
- ◆ Plug-and-play ready for IBM AT/XT, PS/2 and Compatibles, MAC, SUN, HP, Silicon Graphics and others.

The PMO-650 is faster than a Seagate® ST4350N magnetic hard drive and five times faster than Sony's® SMO-E501 optical drive.

With speeds faster than most hard drives, the PMO-650's applications

XXBENCH TEST XCOPY.EXE DISK TRANSFER				
Drive Tested	5 Mb transfer	10 Mb transfer	50 Mb transfer	100 Mb transfer
ELAPSED TIME IN SECONDS				
Pinnacle PMO-650™	38.44	74.28	457.77	921.28
Sony® SMO-E501	185.04	396.31	2941.88	4995.14
Seagate® ST4350N 350MB	61.26	125.06	819.79	1520.14



are endless. It can replace existing hard drives for general data storage or can be used for vertical applications such as digital audio, digital video or multimedia. The PMO-650 is the ultimate storage solution. It's more than a hard drive. It's optical.

☎ 800-553-7070



Pinnacle Micro World Headquarters



THE OPTICAL STORAGE COMPANY

LETTERS

Now We Know . . .

In case you were wondering, yes, I did notice the hidden letters on your February 1992 cover.

M. Brasse
Schinnen, The Netherlands

It's true, the "hidden" letters in the circuit traces spell I-B-M. Did anyone feel an overwhelming urge to buy a PS/2?—Eds.

Internet Excellence

As one of the millions of Internet users, I was very pleased to discover another article on the single most important advance in communications history since people began speaking ("Applying the Internet," February). I hope that BYTE will obtain without delay an Internet address for those of us who can't afford BIX and don't wish to use snail-mail or fax. You might also want to offer a monthly Internet column as a way of popularizing the Net and encouraging network citizenship.

David Mattison
Victoria, BC, Canada

Ask and you shall receive. BYTE's editors already have Internet addresses. Now we have an Internet address for letters as well. Send your comments to letters@bytepb.byte.com.—Eds.

Multimedia Isn't Cutting It

I've read lots of solemn discussions lately about multimedia, and how it will be used for training, business presentations, and so on. These guys must be kidding! The main uses of multimedia will be pop videos, games, and X-rated movies. That's where the money is.

If you accept this, then it's obvious that the Philips-Sony approach of making the multimedia player as simple to use as possible is correct, and the IBM-Microsoft idea of extending the PC to do the job is a loser. Things like training and business presentations will be small-time spin-offs from the main business.

Michael J. White
Wahroonga, Australia

Gallium Arsenide Issue

I was surprised to read in "Gallium Grows Up" (February, page 143) that the electron mobility of GaAs increases with temperature. All the references that I have show that above 100 K the opposite is true, as μ_n reduces at a rate between $1/T$ and $1/T^2$ depending on the actual material and measurement technique. This does not

WE WANT TO HEAR FROM YOU. Address correspondence to Letters Editor, BYTE, One Phoenix Mill Lane, Peterborough, NH 03458, or send BIXmail c/o "editors." Your letter may be edited for length and clarity.



affect the general conclusion of the article: that GaAs will be incorporated into commercial systems only when its higher manufacturing costs are outweighed by its performance advantages over silicon.

Besides brittleness, another reason for higher manufacturing costs is the demands of the associated processing methods and tolerances. These are brought about by the nature of the currently dominant GaAs device, the MESFET (metal semiconductor field effect transistor), which is not as well suited to logic applications as the silicon MOSFET (metal-oxide semiconductor field effect transistor). In particular, to

keep the number of devices at a minimum (fewer devices mean higher yields), it's necessary to use enhancement-mode MESFETs, which require very accurate control of the thickness of the device's active region. Processing difficulties like these have as much to do with determining the commercial viability of a semiconductor device as the theoretical benefits of the device itself.

Mark Bowser
Essex, U.K.

Great Interruptions

I just finished reading Roger Alford's "How Interrupts Work" (February) and thoroughly enjoyed the content of the article. It was well written, and it clarified the workings of IRQs in the IBM PC and AT.

Jeffrey S. Glenn
Concord, NH

Way Late Mail

Enclosed is something you might find amusing. In 1977, a BYTE reader circled a "bingo" number from the December 1977 issue. In February 1978, we mailed product information in response. Just 14 years later, on January 28, 1992, we received the enclosed envelope back marked "No Forward Order on File."

Incidentally, the product information inside was for the "AD8" S-100 computer-controlled music synthesizer. Carl Helmers, then editor of BYTE, was one of the first customers to buy this product.

Philip Tubb
ALF Products, Inc.
Wheat Ridge, CO

From the markings on the envelope, it appears that ALF's mailing spent 14 years in the USPS Dead Letter Office in St. Paul, Minnesota.—Eds.

FIX

The correct price for Cayman Systems' XGator 1.0 (Reviewer's Notebook, February) is \$295. ■

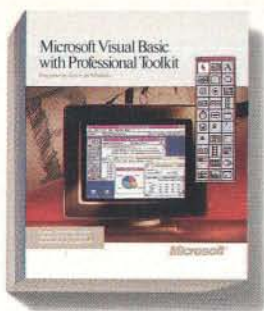

Introducing 36 shortcuts to developing Windows-based applications.

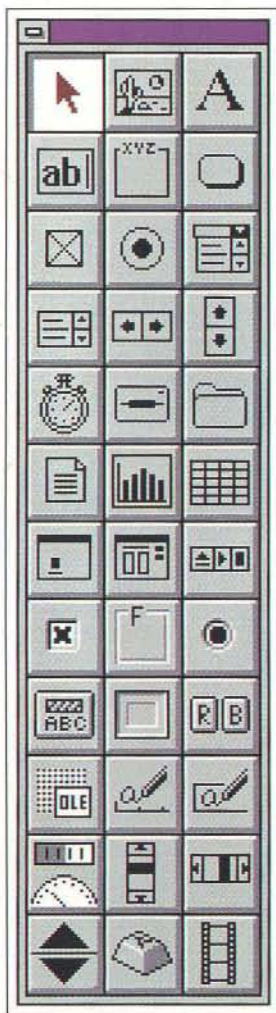

The Toolbox provides instant access to 36 controls.

Take all the great controls that help to make the Microsoft® Visual Basic™ programming system a smash hit. Add 21 more. And you've got Visual Basic 1.0 with Professional Toolkit.

It comes with the handy click-and-drag tools you see here. Including brand-new controls like MDI Child. And Grid (for spreadsheet forms). Plus a Graph control, 3-D controls, and even spin buttons. Together, they let you build custom software with the kind of functionality you've only imagined until now.

And for even greater convenience, you also get tools such as the online Windows API reference.

All of which means you can now create sophisticated, full-featured programs. For everything from vertical applications to broad-based utilities.

So call (800) 541-1261, Department Z87. Ask us about new Visual Basic 1.0 with Professional Toolkit. And make short work of Windows-based applications.

© 1992 Microsoft Corporation. All rights reserved. Printed in the U.S.A. For more information inside the 50 United States, call (800) 541-1261, Dept. Z87; outside the U.S. and Canada, call (206) 936-8661. Customers in Canada, call (800) 563-9048. Microsoft is a registered trademark and Visual Basic and Windows are trademarks of Microsoft Corporation.

Key Features

- Complete application development system for professional programmers.
- Grid control with row and column support.
- MDI (Multiple Document Interface) Child control for creating child windows.
- Graph control with complete charting functionality.
- Windows for Pen computing controls.
- MCI (Media Control Interface) control for Multimedia applications.
- OLE (Object Linking and Embedding) Client control with OLE 1.0 support.
- Windows API online reference.
- Windows Help Compiler for creating .hlp files.
- Extensible via dynamic link libraries (DLLs) and DDE.
- Setup Kit for easy user installation.
- .EXE files may be distributed runtime and royalty free.

PROGRAMMER'S TIPS

- Take advantage of the Common Dialog control to instantly create File Open, File Close, Color, and other standard dialog boxes.
- Use the MDI Child control with a "Window" menu option where 'Tile', 'Cascade', and 'Arrange Icons' options are included for the MDI child windows.

Microsoft

Recent Study 25 MHz Is Now Fast

INGRAM BENCHMARK RESULTS, JANUARY 1992 - 25MHz 040 MACINTOSH QUADRA

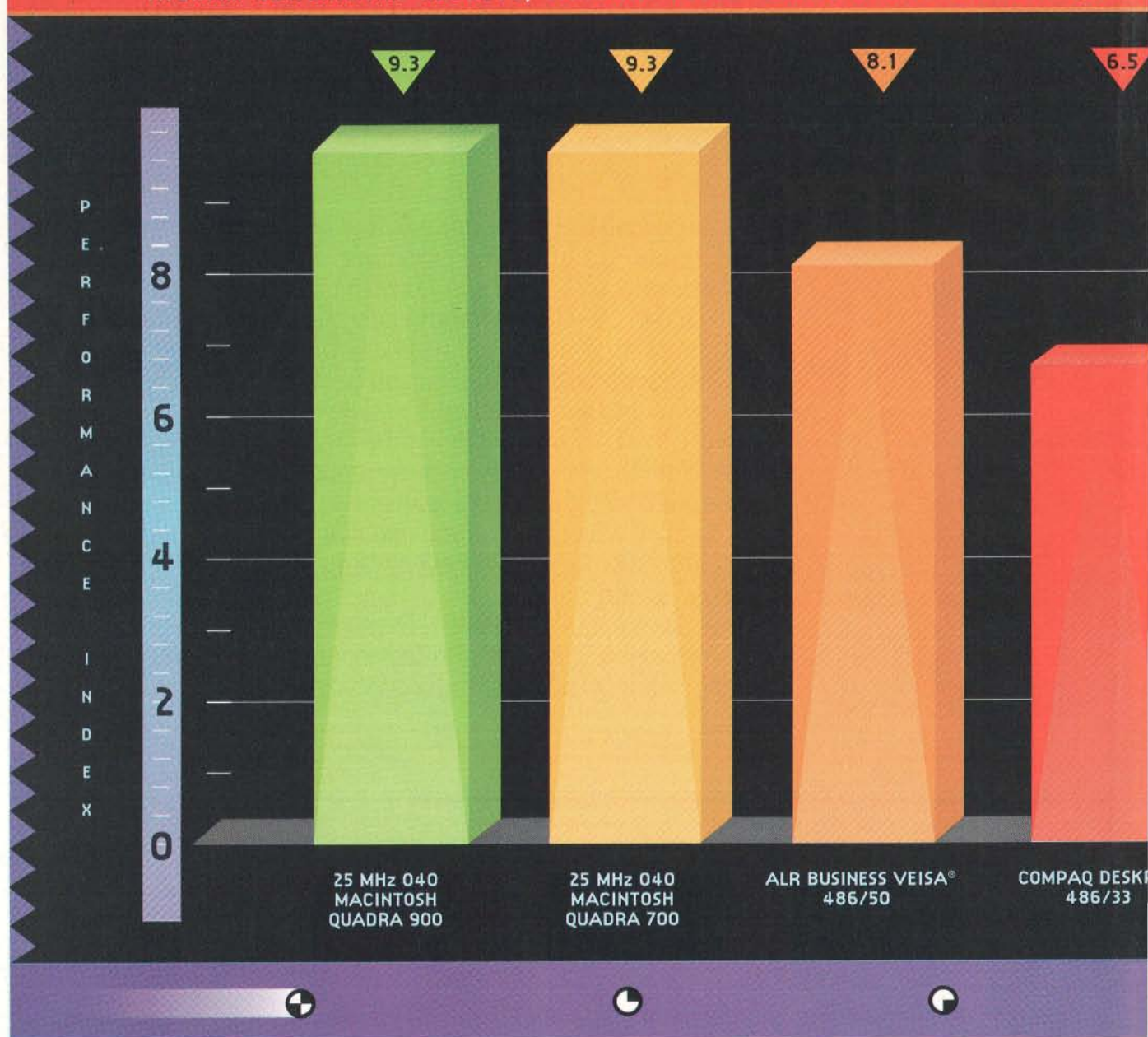

*Performance Index is the measured result relative to the slowest machine tested (a 286-based IBM PS/1 running Windows). For example, the Macintosh Quadra is 9.3 times faster.

†Ingram Performance Report by Ingram Laboratories, published 10/91, revised 1/92. *Software programs used in benchmark test were Microsoft® Word®, Excel®, PowerPoint®, Wingz®, PageMaker®, Persuasion® and Illustrator™. Motorola and the M are registered trademarks of Motorola, Inc. Apple and Macintosh are registered trademarks, Macintosh Quadra is a trademark of Apple Computer, Inc. All other brand or product names indicated by ® or TM are registered trademarks of their respective owners.

udies Reveal ster Than 50 MHz.

UTRUNS THE 486 AT 33 AND 50 MHz

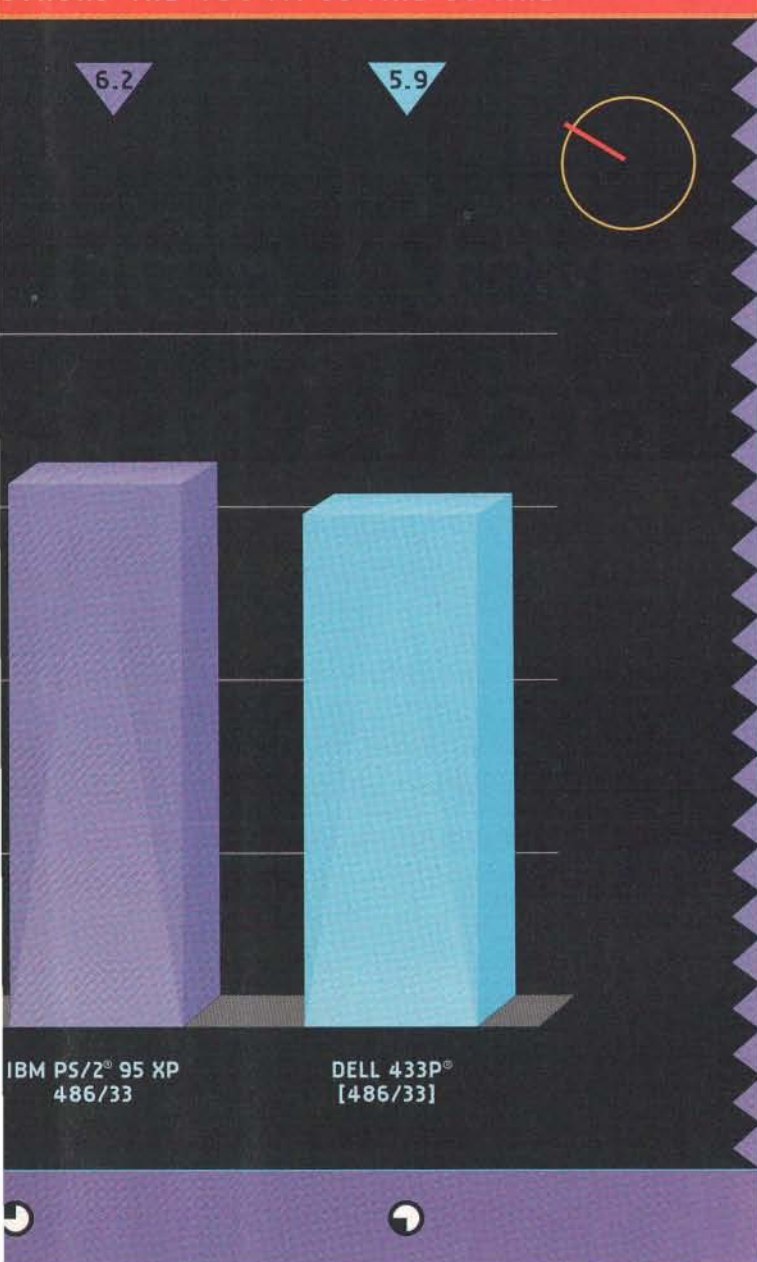

han the Performance Index; the Dell 433P only 5.9 times faster.



This revelation is brought to you by the Apple[®] Macintosh[®] and the Motorola 68040.

Let us explain. Ingram Laboratories¹, a leading independent PC testing firm, recently lined up the new Macintosh Quadra[™] 700 and 900, powered by 25 MHz 68040s, and several of the quickest 50 MHz and 33 MHz 486[®] Windows[™] PCs on the market.

They loaded the computers with the most popular programs available for both Macintosh and Windows 3.0. Then measured the time it took each machine to perform real world functions like opening a file, scrolling, running a macro, performing calculations and so on.

The result? The 25 MHz 040-based Macintosh Quadra was 15 percent faster than the 50 MHz 486 Windows PC. And it blew the 33 MHz 486 boxes right out of the room.

No surprise, really. Macintosh and its graphical user interface were designed from the start around the 68000's true 32-bit architecture. Naturally, it outperforms computers powered by an extended 8-bit architecture running a character-based operating system with a tacked-on GUI.

So if you're looking for a high performance graphical computer, there's only one way to go.

Go Macintosh Quadra and the 040.



For a free copy of the Ingram test results, call 1-800-845-MOTO.



MOTOROLA

marks or trademarks of their respective holders. ©1992 Motorola, Inc. All rights reserved.

Circle 131 on Inquiry Card.

**SOFTWARE
VERSION**



COREL SCSI!

The Best Way to Connect PC Peripherals

CorelSCSI software allows top speed connection of up to seven PC peripherals to a single SCSI adapter card! New peripherals can simply be "daisy-chained" to your existing one, without the hassle of adding new adapter cards.

It's a great way for PCs, notebooks or laptops to easily connect to the huge range of SCSI peripherals available.

CorelSCSI ensures total compatibility, and includes drivers for virtually all SCSI devices such as: hard drives, removable drives, rewritable drives, WORM drives, tape drives, CD-ROM drives, multifunction drives and jukeboxes.

With the ability to support hundreds of devices and with the exceptional bonus utilities, CorelSCSI software offers incredible value!



1-800-836-7274
FAX: (613) 761-9176
CDN TEL: (613) 728-8200

1-800-836-SCSI

All product and company names are trademarks of their respective corporations

▶ CorelDRIVER Software with support for 100's of devices

BONUS Corel Tape Back-up Software

BONUS SitBack™ Software for unattended backups

BONUS Corel CD-AUDIO for Windows

BONUS Additional programs and utilities



Also available:
Complete Interface Kits
• SCSI host adapter
• SCSI software
• SCSI cable and "Easy to Install" video

NEWS

MICROBYTES

Nutek: A Mac Emulator in Progress

Early last year, Nutek Computers (Cupertino, CA) announced that it had developed a Mac-compatible operating system and a set of chips that let system vendors make Mac clones without infringing on Apple's patents or copyrights. After the announcement, Nutek continued to quietly plug away at its Mac equivalent, shunning the glare of publicity. However, the company recently reappeared at the CeBIT show in Hannover, Germany, with a logic board complete with a 68030 processor. BYTE staff subsequently spent several hours with Nutek representatives at their U.S. offices and discovered that the Nutek system is still a work in progress, but it's real. Nutek hasn't decided if it will sell the board to system manufacturers or through dealer/distributor channels.

Nutek shuns the term *clone* for its computer because the word suggests the idea of a copy. The hardware isn't a precise duplicate of the Mac, and the software was written independently, not copied. The main logic board—the actual hardware that Nutek will sell—resembles that of a Mac IIci. The board has a 33-MHz 68030 CPU, three NuBus slots, two miniature DIN-8 serial ports, and DB-25 and internal 50-pin ribbon SCSI connectors that are managed by two 53C80 SCSI controller chips. Sound input and stereo-sound output ports handle sample rates of 22 and 44 kHz. The system also offers built-in video using a DB-15 (Apple standard) connector and two connectors for floppy drives. The keyboard and mouse, however, use PS/2 connectors.

Prototypes have a standard PC chassis, a 40-MB SCSI drive, and a Fujitsu floppy drive that writes 800-KB GCR (Group Code Recording)-encoded floppy disks and has software-controlled disk ejection. Shipping units will use PC-standard 1.44-MB floppy drives with MFM encoding.

Three on-board custom ASICs (application-specific ICs) serve as the glue between Nutek's Mac OS/firmware emulation and the mixture of Mac and PC hardware. Nutek chip 1 handles all I/O and the real-time clock. Nutek chips 2 and 3 manage memory control and the NuBus interface. DMA channels are used with the SCSI, floppy drive, and sound subsystems. An EEPROM chip holds boot code that loads Nutek's clean-room implementation of the Mac Toolbox and operating system from a floppy or hard disk into main memory. The reason for loading the firmware this way—a method that's similar to what early Amigas did with their KickStart code—is twofold: It's easier to patch the firmware and provide updates to users in the field, and the code executes faster in RAM. This firmware is a comprehensive implementation of System 6.0.x software managers and a subset of System 7.0 features.

Firing up the Nutek emulator, you see a slightly different interface. Unix wizards will recognize it at once—Motif. However, this appearance is only screen-deep: Motif supplies only the GUI; the rest is Nutek's Mac OS emulation. Motif adds its own twists to the interface. The menus behave differently, and the menu bar appears inside the active window. For Mac Command-key equivalents on the 101-key standard PC keyboard, you hold down the Alt key and press the appropriate second or third keys. Nutek substitutes its own bit-mapped fonts for the standard Apple System fonts of Geneva, Monaco, and Chicago.

Nutek's board is meant to support the major mainstream applications. The company's target is the less sophisticated user who runs only several major applications (e.g., a word processor and a page-layout application).

The system was run using two Claris applications, MacWrite and ClarisWorks. They worked without apparent problems, as did a copy of PageMaker 3.0 from Aldus. But the system had trouble with PageMaker 4.2 and with a PageMaker document with a color TIFF file and several EPS (Encapsulated PostScript) files embedded in text. The TIFF file reproduced correctly, but the placement bit maps for the EPS files were garbled, apparently due to a scaling problem.

continued

NANOBYTES

USRobotics (Skokie, IL) has developed a modem for the **Hewlett-Packard 95LX**. The \$249



WorldPort Fax Data Palm top Modem's communications

software is built into the modem and runs on a 9-V battery. An AC adapter is included. □

Exactly two years after it first announced the project, Quarterdeck Office Systems (Santa Monica, CA) released **Desqview/X**, its 32-bit operating system that lets 386SX or higher PCs run graphical X Window System programs residing on a Unix host. Desqview/X also lets the same Unix hosts or X terminals run DOS or Windows programs residing on the PC. "Getting Microsoft Windows to run remotely on a Sun workstation was the final step," said Therese Myers, Quarterdeck's president. □

Sun Microsystems has spun off another company, **SunSelect**, that will focus on products to bridge the PC and Unix environment. The new company, to be headquartered in Billerica, Massachusetts, will assume responsibility for Sun products that will integrate PCs and PC LANs with Unix. □

Apple is developing A/UX 3.0 Secure, a **C2-level** certifiable version of its Unix variant. It expects the operating system to be available in the fourth quarter of this year. □

A 1991 trip to Latvia by U.S. business executives has resulted in the formation of **Basec** (Boston, MA), a company that has developed a program that aggregates data in Excel 3.0 for Windows. Versions for other spreadsheets are planned. □

**IF IT HAS ADOBE^{*}
SCALABLE FONTS,
COLOR, AND
QUIET TECHNOLOGY,
IT CAN ONLY BE
FROM PANASONIC.**

Panasonic
KX-P2124
Quiet Printing **24 PIN**

Multi-Mode Printer

The KX-P2124, a 24-pin with ATM and color option.*

A few dot-matrix printers offer you scalable fonts.

A few, color. But no other printer offers you scalable fonts...color...and Panasonic® Quiet Technology.

Put our KX-P2124 and 2123 to work and you'll get the flexibility of Adobe Type Manager® and scalable fonts...you'll add drama to your documents with our optional color kit...and you'll hear very little, indeed.

Put any of our other Quiet Technology printers to work and you can accomplish whatever your needs.

From our 2123, a budget-minded 24-pin with Adobe Type Manager* and optional



ATM™



color...to our 2624 wide-carriage business printer with ATM*,...to our 9-pin 2180 with 6 near letter quality fonts and optional color.

All with the kind of features that made Panasonic printers the leaders of the industry. Such as multiple paper paths, EZ™ Set control panels, and a two-year limited warranty on parts and labor†.

The Panasonic 2000 Series Quiet Technology Printers.

Call us for more information: 1-800-742-8086. Or visit your Panasonic dealer.

†See your dealer for warranty details.

*ATM and Adobe Type Manager are registered trademarks of Adobe.

Available on selected printers only.



**ONCE YOU'VE TRIED OUR
QUIET TECHNOLOGY PRINTERS,
YOU'LL NEVER SETTLE FOR
ANYTHING LESS.**



The KX-P2123, a 24-pin with ATM and color option.*



The KX-P2180, a 9-pin with color option. ATM not available.*



The KX-P2624, a 24-pin with ATM. Color option not available.*

PQ9-BY

Circle 135 on Inquiry Card.

The Mac low-level benchmarks showed interesting results: The floating-point tests, using SANE (Standard Apple Numeric Environment), ran fine, but the video tests did not. From the looks of the erratic screen updates in PageMaker, there's still work to be done on the Window Manager. Nutek is also talking to SuperMac and RasterOps to help provide support for their display systems.

Nutek has gone to great lengths to document its clean-room design of the Mac firmware. There are no ex-Apple employ-

ees, and the work is archived into a third-party vault for future reference. The company has also allocated funds to handle a potential lawsuit. Patented technologies, such as the ADB (Apple Desktop Bus) mouse/keyboard and AppleTalk protocols, are not present in Nutek's design. There's no doubt that Nutek is pulling off an admirable feat in emulating a Mac. Whether the company can get the implementation thoroughly debugged and persuade people to buy it is an unanswered question.

—Tom Thompson

Industry Veterans Found Research Company

Paul Allen, the president of Asymetrix, and David Liddle, the founder of Metaphor, have founded a new company, called Interval Research (Palo Alto, CA), with the goal of performing research and advanced development in areas of new technology. The company probably won't produce any products; instead, it will either license technology to other companies or spin off new companies to further develop and market technologies that it has created. Allen described the latter technique as a way of allowing researchers to profit directly from a new discovery or invention.

Interval Research will focus its efforts on

information systems, communications, and computer science. Allen said that some of the initial areas of research would include "domain-specific software design, applications for new data services, ubiquitous computing, new human interaction models, and generic encoding of on-line knowledge." He was not specific about the details of these areas of research, but he did say that the research would go beyond what people see today and would involve dealing with the difficult problems of computing across different platforms and operating systems.

—Owen Linderholm

News from Apple: How VITAL for Independent Software Vendors?

In the coming months, Apple plans to release products based on VITAL (Virtually Integrated Technical Architecture Lifecycle), a conceptual framework for integrating the Mac into enterprise computing systems. At the March DB/Expo in San Francisco, the company released a series of five documents describing the framework, the first of which presents a set of architectural principles, models, and guidelines. Products will follow over the coming months, Apple said.

Underlying all the talk of open systems and vendor-independent interoperability,

Apple is promoting its own set of APIs to database and network services. Collectively called the Integration Services Manager API, Apple's interfaces provide access to relational databases (Data Access Manager), network protocols (Communications Toolbox), message services (Open Collaborative Environment), and on-line transaction services (Transaction Submittal Services). Unlike similar efforts from Microsoft and Borland, Apple is pitching its API plans not to independent software vendors but to corporate MIS departments.

—Ellen Ullman

FDDI Follow-Ons? Gigabit Networks Coming

FDDI (Fiber Distributed Data Interface), the 100-Mbps successor to today's networks, has only just arrived. However, it is already being stigmatized as too slow and poorly suited to meeting the emerging needs of network customers, especially in regard to multimedia.

In general, video and multimedia are a problem for conventional networks for two reasons. First, video—even compressed video—requires a lot of bandwidth. Second, and more subtly, the packet-based nature of most network protocols is a poor match for video. In general, packets of

NANOBYTES

Having announced its intention to acquire Fox Software (Perrysburg, OH), Microsoft (Redmond, WA) is placing itself in head-to-head competition with Borland International for control of the personal computer database market.



Fox's database development group will move to Microsoft's headquarters in Redmond, and Fox president and cofounder **David Fulton** will become a database archi-

tect. Fulton declared himself "delighted about all of it," and he showed no apparent regret about the forthcoming change in his status from company president to technical manager. Referring to Microsoft's vast resources, Fulton said, "I feel like a kid with the biggest electric train in the world." □

As part of the Microsoft/Fox announcement, Bill Gates, chairman and CEO of Microsoft, revealed details about his company's rumored **Cirrus** desktop database product. Gates said that Cirrus is a graphical browsing and management tool, based on Visual Basic, that lets developers and users access enterprise-wide data sources. Both Cirrus and FoxPro will use the Open Database Connectivity programming interface as front ends to a wide variety of data sources, including SQL (Structured Query Language) databases. Cirrus should soon be entering the beta-test stage. □

A 24-hour digital assistant that never takes a coffee break? That's how Xerox (Palo Alto, CA) describes **PaperWorks**, a Windows-based program that lets you remotely retrieve, store, and distribute documents using any fax machine. With special forms that you fax to a PC or fax server, you can send out documents to any other fax machine. Boxed fields in the forms let you indicate recipients' fax numbers. □

Delivering the Power: WATCOM C9.0/386

- ▶ **The Widest Range of 32-bit Intel x86 Platforms**
32-bit DOS, 32-bit Windows, OS/2 2.0, AutoCAD ADS
- ▶ **The Industry's Leading Code Optimizer**
Advanced global optimizer with new 486 optimizations
- ▶ **The Most Comprehensive Toolset**
Debugger, profiler, protected-mode compiler and linker, 32-bit DOS extender with royalty-free run-time, licensed components from Microsoft SDK, and more
- ▶ **The Best Value in 32-Bit Tools: \$895***

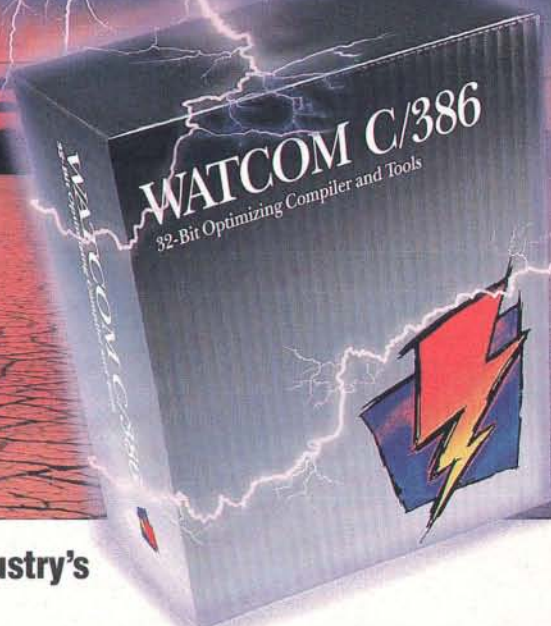

Unleash 32-bit Power!

WATCOM C9.0/386 lets you exploit the two key 32-bit performance benefits. The 32-bit flat memory model simplifies memory management and lets applications address beyond the 640K limit. Powerful 32-bit instruction processing delivers a significant speed advantage: typically at least a 2x speedup.

You Get:

- ▶ **100% ANSI and SAA compatible:** C9.0/386 passes all Plum Hall Validation Suite tests
- ▶ **Extensive Microsoft compatibility** simplifies porting of 16-bit code
- ▶ **Royalty-free run-time** for 32-bit DOS, Windows and OS/2 apps
- ▶ **Comprehensive toolset** includes debugger, linker, profiler and more
- ▶ **DOS extender support** for Rational, Phar Lap and Ergo
- ▶ **Run-time compatible with WATCOM FORTRAN 77/386**

32-bit DOS support includes the DOS/4GW 32-bit DOS extender by Rational Systems with royalty-free runtime license

- ▶ Virtual Memory support up to 32Mb

32-bit Windows support enables development and debugging of true 32-bit GUI applications and DLLs.

- ▶ Includes licensed Microsoft SDK components

32-bit OS/2 2.0 support includes development for multiple target environments including OS/2 2.0, 32-bit DOS and 32-bit Windows

- ▶ Access to full OS/2 2.0 API including Presentation Manager
- ▶ Integrated with IBM Workframe/2 Environment

AutoCAD ADS and ADI Development: Everything you need to develop and debug ADS and ADI applications for AutoCAD Release 11

Novell's Network C for NLM's SDK includes C/386

The Industry's Choice.

Autodesk, Robert Wenig, Manager, AutoCAD for Windows:

"At Autodesk, we're using WATCOM C/386 in the development of strategic new products since it gives us a competitive edge through early access to new technologies. We also highly recommend WATCOM C/386 to third party AutoCAD add-on (ADS and ADI) developers."

Fox Software, David Fulton, President: "FoxPro 2.0 itself is written in WATCOM C, and takes advantage of its many superior features. Optimizing for either speed or compactness is not uncommon, but to accomplish both was quite remarkable."

GO, Robert Carr, Vice President of Software: "After looking at the 32-bit Intel 80x86 tools available in the industry, WATCOM C was the best choice. Key factors in our decision were performance, functionality, reliability and technical support."

IBM, John Soyring, Director of OS/2 Software Developer Programs: "IBM and WATCOM are working together closely to integrate these compilers with the OS/2 2.0 Programmer's Workbench."

Lotus, David Reed, Chief Scientist and Vice President, Pen-Based Applications: "In new product development we're working with WATCOM C because of superior code optimization, responsive support, and timely delivery of technologies important to us like p-code and support for GO Corp's. PenPoint."

Novell, Nancy Woodward, V.P. and G.M., Development Products: "We searched the industry for the best 386 C compiler technology to incorporate with our developer toolkits. Our choice was WATCOM."

WATCOM

1-800-265-4555

The Leader in 32-bit Development Tools

415 Phillip Street, Waterloo, Ontario, Canada. Telephone: (519) 886-3700. Fax: (519) 747-4971. *Price does not include freight and taxes where applicable. Authorized dealers may sell for less. WATCOM C and Lightning Device are trademarks of WATCOM Systems Inc. DOS/4G and DOS/16M are trademarks of Rational Systems Inc. Other trademarks are the properties of their respective owners. Copyright 1992 WATCOM Products Inc.



Circle 173 on Inquiry Card.



OS/2

*In Canada, call 1 800 465-1234. **Upgrade from Windows, \$49; upgrade from DOS, \$99; \$139 base operating system. These prices valid only when ordered directly through IBM. Proof of purchase required. Dealer prices may vary. Offer valid in U.S.A. only, expires 7/31/92. HelpWare limited to U.S.A. only. IBM and OS/2 are registered trademarks and OS/2 Crash Protection, Workplace Shell and HelpWare are trademarks of International Business Machines Corporation. All other products are trademarks or registered trademarks of their respective companies. ©1992 IBM Corp.

Starting today, everything your computer has ever done, it will do better.

If you thought you knew what OS/2[®] was all about, think again. This is 32-bit OS/2 2.0, and it's more than a promise. It's a breakthrough. An operating system that takes your DOS, Windows[™] and OS/2 applications beyond the limitations of the past—lets you do more with them than you ever could with DOS, DOS with Windows and OS/2 1.3.

It also runs multiple DOS, Windows and OS/2 applications at the same time, regardless of version, in separate windows on the same screen—seamlessly. In other words, true multitasking. And with OS/2 Crash Protection[™], each running application is protected from the next, so if one goes down it won't affect the others.

About the only thing better than how much more OS/2 can do, is how easily it does it all. There's a graphical interface that makes OS/2 easy to install, learn and use—the Workplace Shell[™]. And OS/2 comes with HelpWare[™]: a collection of services and support, including a toll-free number. But maybe the best part is that instead of buying DOS, Windows and Adobe Type Manager[®], you get them all with OS/2. So for a whole lot less, OS/2 2.0 gives you a whole lot more.

With OS/2, your software can catch up with your hardware. And you can do the only thing you haven't been able to do with your computer. Make the most of it. For an IBM authorized dealer near you, or to order OS/2 2.0—at special introductory prices of \$49 for Windows and \$99 from any DOS—call 1 800 3-IBM-OS2*.



Introducing OS/2 2.0.

- Runs DOS, Windows and OS/2 applications from a single system.
- Workplace Shell: an easy-to-use, graphical interface.
- Up to 48MB expanded memory per application. No 640K limit.
- Makes the most of 386 SX hardware and above.
- Upgrade from Windows to OS/2 2.0 for \$49; \$99 from any DOS.**

computer data must all arrive, although they don't have to be in order. Video and voice can withstand the loss of information to a certain degree, but they don't handle out-of-order data well.

Backers of FDDI are already talking about FFOL (the FDDI Follow-On LAN), which has speeds of at least 600 Mbps and possibly 1 Gbps. The need for high-speed WANs (wide-area networks) has fueled other activity. IBM is getting ready to conduct field trials of a 1-Gbps WAN called PLANET (Packetized Lightwave Architecture Network) at its Thomas J. Watson Research Center (Yorktown Heights, NY). And IBM's 1-Gbps LAN, Metaring, is scheduled to start tests this summer. In ad-

dition, ANSI has established a subcommittee of X3T9.5 to establish FDDI II to handle higher throughputs.

Like FDDI, all the candidates are optical-fiber networks; however, they use the fiber bandwidth differently. Most of them are broadband networks that carry multiple channels on the same fiber. Metaring uses single-channel fiber. PLANET features real-time packet delivery to prevent jerky video. FDDI II is a hybrid that combines a packet-based protocol for data and a virtual circuit for video and voice.

None of these networks is going to happen soon. Developers say that the networks are years away from general availability.

—Rick Cook

NANOBYTES

Lotus is developing a visual programming application called Notebook that lets you integrate relational data with Notes data. The company demonstrated how you can query sales data in a Sybase database and put it live into a window next to a Notes database using



visual programming methods. Applications created with Notebook can be distributed through Notes. Lotus's chief technical officer **John Landry** said that Notebook offers CASE "where the graphical representation of the data is not just a description of the system, it is the system." □

The first week of April is usually associated with the opening day of major league baseball, but for industry observers, it was more like **open season on operating systems**, as IBM, Quarterdeck, and Microsoft all strove to capture the market. IBM developers had to work down to the wire, but the company released the general-availability version of OS/2 2.0 by its self-imposed deadline of March 31. Quarterdeck announced the release of Desqview/X at the Federal Office Systems Exposition in Washington, D.C. And Microsoft's Bill Gates used the occasion of his Windows World keynote speech at Comdex to launch Windows 3.1. □

Microsoft may have the marketing muscle, but it hasn't yet released a 32-bit operating system. However, the company will probably release a beta version of **Windows NT** (New Technology) in July to independent software vendors. The company has already implemented a controlled beta-test program for NT with a few hundred customers. □

Shortly after MiniStor Peripherals' announcement, **NEC** announced a 1½-inch 85-MB hard drive. □

Lotus and Novell Strengthen Ties with Notes NLM for NetWare

In a deal that represents the most substantial collaboration since their failed merger two years ago, Lotus Development and Novell are integrating Lotus's Notes group communications package into the NetWare environment. Lotus will develop a version of its client/server Notes package that will run natively on NetWare servers and support Novell's MHS (Message Handle Services) messaging protocol. The companies will also cooperate on marketing efforts, including joint training on Notes for Novell's pool of VARs (value-added resellers).

Notes executes only on OS/2 1.x servers and OS/2 PM (Presentation Manager) or Windows clients. Thus, customers who want to use Notes in the NetWare environment must run it on a separate OS/2-based server that communicates with NetWare via an OS/2 requester. By rewriting Notes as an NLM (NetWare loadable module) for the 32-bit NetWare 386, Lotus will let customers run the server component of the package without an OS/2 machine.

Lotus will make the move to NetWare in several stages. First, Notes 3.0 (as well as the next version of cc:Mail), both ex-

pected before the end of this year, will add support for Novell's NetWare IPX/SPX transport protocols. (Lotus has said that it will add support for Mac clients in the same release.) In a separate development, Lotus will deliver Unix client and server versions of Notes in early 1993.

Late in the first half of 1993, Lotus plans to ship the Notes NLM, which will also fully support MHS and NetWare Global Messaging, as alternatives to the Notes messaging engines. Users will be able to use multiple mail transports concurrently, Lotus says. And by supporting MHS, Notes will be able to connect with any back-end mail system that NetWare supports.

In roughly the same time frame, Lotus and Novell will be moving to use the emerging VIM (Vendor-Independent Messaging) standard, of which they are key proponents and developers. Both companies also say that they are migrating toward the use of X.500 global-directory services in their mail and messaging products. The Notes NLM will require NetWare 3.2, which is scheduled to ship in the fourth quarter of this year.

—Andy Reinhardt

MiniStor Unveils Tiny Notebook Drives

A San Jose-based start-up company has unveiled a new family of hard drives that continues the trend of shrinking rotating magnetic media. This could pose a challenge to the acceptance of more expensive solid-state storage cards.

MiniStor Peripherals' Portables series

of subminiature drives uses 1½-inch platters instead of the 2½-inch platters now common in notebook drives. The drives, which are now shipping in evaluation quantities, will be available in various sizes and thicknesses. The slimmest model, a removable drive with a 32-MB capacity, can fit into a

newly defined type of 10.5-mm-thick PCMCIA slot. It also uses only about half as much power as a typical 2½-inch drive, MiniStor says.

An amendment to the PCMCIA 2.0 standard, approved in February, defines a thicker slot type called a Type III cavity. You can install into one of these 10.5-mm slots two of the thinner (3.3-mm or 5-mm) PCMCIA-compatible cards or one thick device, such as the MiniStor MiniPort 32P hard drive. Either way, the electrical and logical interface to the system is the same.

MiniStor will also deliver three other models this year: embedded 1½-inch drives in 32- and 64-MB capacities (the latter uses two platters) and a removable 64-MB drive that uses a nonstandard 13.5-mm slot. All the drives include IDE interfaces and large read/write buffers that MiniStor

says boost performance by two to eight times over competing 2½-inch drives.

End users will see MiniPort drives in systems before the end of the year; several are slated to be announced at Fall Comdex, MiniStor says. The only other 1½-inch drives now on the market are from Integral Peripherals, a spin-off of defunct PrairieTek. The drives are thicker and are not designed for PCMCIA slots. Conner, Quantum, and other players are expected to announce 1½-inch drives, but for now, MiniStor has the lead.

At \$425 for engineering samples, MiniPort drives will cost less than equivalent-size solid-state disks. This lower cost will delay yet again the obsolescence of hard drives by silicon storage. Also, drives smaller than 1½ inch may be announced soon.

—Andy Reinhardt

Instant Gigabytes?

In an announcement that has generated quite a bit of interest and more than a healthy dose of skepticism, WEB Technologies (Smyrna, GA) says it has developed a utility that compresses files larger than 64 KB to about one-sixteenth their original size. Furthermore, WEB Technologies says its DataFiles/16 program can compress files that the program has already compressed.

Conventional compressors typically are doing well when they can reduce a file to one-half its original size. WEB Technologies' claim of 16-to-1 lossless compression, if true, would be a remarkable coup. In fact, according to the company, virtually any amount of data can be compressed to under 1024 bytes by using DataFiles/16 to compress its own output files multiple times.

A basic tenet of a long-studied branch of computer science called *information theory* says there is a theoretical minimum amount of space (bits or bytes) required to represent any given set of information (i.e., a file). Different files can be represented in different amounts of space, depending on the degree of entropy, or *randomness*, they contain. Files containing predictable sequences of information can be compressed significantly; files containing random information cannot be compressed at all. Text files, which often hold repeated or predictable sequences, have relatively little randomness and can often be represented in half their original space. Program files are usually more random than text files and are correspondingly less compress-

ible. According to information theory, the act of compressing a file increases its randomness and reduces or eliminates its capacity for further compression.

According to Earl Bradley, WEB Technologies' vice president of sales and marketing, the compression algorithm used by DataFiles/16 is not subject to the laws of information theory. The company's spokespersons have declined to discuss the nature of the algorithm.

WEB Technologies released a beta-test version of DataFiles/16 to this reporter for a preliminary evaluation. The program did create archive files that were compressed to the degree that the company claimed. The beta version decompressed these files into their original names and sizes, but, unfortunately, the contents of the decompressed files bore little resemblance to that of the original files.

WEB Technologies' representatives met with a BYTE news editor and demonstrated the program's ability to successfully compress a text file three times without losing the data. But at press time, this reporter wasn't able to test the latest beta version of the utility, and so couldn't verify the company's revolutionary claims.

The DOS version of DataFiles/16 (Mac and SCO Unix versions are waiting in the wings) was to have shipped in March. The company now claims that the product will ship by May 1. If it does, information theorists will have a lot of explaining to do, and you ought to be able to fit the contents of the Library of Congress on your floppy drive. ■

—Russ Schnapp

NANOBYTES

Kodak is planning a huge push for its Photo CD products. The company intends to have more than 200,000 Photo CD outlets nationwide this month. At these outlets, customers can turn in rolls of film or sets of negatives, and Kodak will develop them, scan the resulting image, color-balance it, and return a Photo CD containing five digital versions of each photograph. □

Apple says it will support Kodak's Photo CD images in future versions of **QuickTime**, giving Mac users direct access to Photo CD images from within their applications. □

Apple has released the **Mac LC II**, which is based on the Motorola 16-MHz 68030 processor. Like the original LC, the Mac LC II integrates color text and graphics, sound input, and the ability to run Apple II software on an optional Apple IIe Card. The LC II replaces the machine that Apple says has become its most popular color Mac. □

At IBM's OS/2 2.0 rollout, **Paul Pignatelli**, owner of the Corner Store (Litchfield, CT), was so enthusiastic about the new operating system that he literally left Borland's Philippe Kahn speechless. When Pignatelli received a beta version of the operating system, he decided to sell OS/2 2.0 as the only operating system at his computer store. According to Pignatelli, using a 16-bit operating system on a 32-bit processor is like never getting past second gear in an expensive sports car. "OS/2 assuages these almost moral perplexities," he said, and it will bring the personal computer world "miracle programs" that will be subsumed into our entire culture. □

Go Corp.'s PenPoint mobile operating system, which was released in April, could support cursive-handwriting recognition by the end of this year, thanks to an arrangement with Paragraph International, a Russian-American developer of handwriting-recognition technology. ■

ION
SORS SOLD

ONE MILLION
MATH COPROCESSORS SOLD

intel®
87™

ION
SSORS SOLD

intel®
i387™

ONE MILLION
MATH COPROCESSORS SOLD

It takes lots of screaming fans



Eleven million, to be exact. And in the math coprocessor business, that's definitely a record.

It just goes to show that Intel is the de facto standard in math

coprocessors. And has been for the last ten years.

Not surprisingly, a whopping nine out of ten math coprocessors in use today carry the Intel name. And you can bet almost every one of them is sitting right next

to an Intel CPU.

Get the connection? It's as perfect a match as you can get. Intel Math CoProcessors are 100% compatible with your Intel CPU, not to mention more than 2,100 software applications.

ONE MILLION
MATH COPROCESSORS SOLD

ONE MILLION
MATH COPROCESSORS SOLD

intel
i387™

intel
i387™

ONE MILLION
MATH COPROCESSORS SOLD

ONE MILLION
MATH COPROCESSORS SOLD

to go platinum eleven times.

It's all part of Intel's commitment to providing powerful solutions today, like the world's fastest microprocessors, plus the enhancements for even greater

WE MAKE COMPUTERS WORK HARDER.
Call and ask for packet BZ
1-800-538-3373

performance. Today and down the road.

To receive a detailed information packet about the complete family of Intel Math CoProcessors, call 1-800-538-3373.

You'll see why Intel Math CoProcessors have topped the charts for ten years running.



Circle 117 on Inquiry Card.

The Best of Comdex/Spring

RICH MALLOY

BYTE editors pick the best products at Comdex/Spring

Comdex/Spring show for two days, argued, yelled, and voted for 3 hours. At the end, we had accomplished our goal: selecting the winners of our Best of Comdex/Spring Awards. And this year, the job was particularly gratifying because it was the most exciting Comdex/Spring many of us had ever attended.

What made this year's annual spring computer trade show exciting was something that was usually in the background at these shows: software. Most shows of the past were dominated by hardware. But now, with some hardware products being relegated to the role of commodities, the emphasis had to change.

The scene was a small conference room high up in a Chicago hotel. Fourteen editors were huddled around a table littered with product literature, soft-drink cans, and several partly eaten Chicago-style deep-dish pizzas. The editors, tired and hoarse from running around the

Best Software

With a whole building devoted to Windows, it is not surprising that the finalists for the Best Software Award are Windows applications.

One of these finalists, from a new division of Xerox called XSoft, is Rooms for Windows. With this \$99 software, you can divide Windows into a series of desktops called rooms, each one customized for a particular application. Once you have your rooms set up, you can quickly switch between them.

Another finalist for Best Software is another program for making Windows more manageable: Outside In for Windows from Systems Compatibility. This \$89 utility lets you view spreadsheet and database files, as well as almost every word processing file imaginable.

The winner of the Best Software Award is a database program: Approach for Windows from Approach Software (see photo 2). This \$399 program makes it easy to create and manage a relational database, and it lets you quickly create high-quality data-entry forms and reports. The software can also access data in dBase, Paradox, and Oracle SQL (Structured Query Language) files.

Best System

A finalist for Best System is the well-designed T386SX notebook from Librex Computer Systems. This \$2499 5-pound system sports a removable hard drive and a PCMCIA expansion slot, a 9½-inch VGA monochrome LCD, and an external floppy drive.

Another finalist is the impressive T4400SXC color notebook from Toshiba. This 7½-pound system combines a 25-MHz 486SX chip with an 8½-inch active-matrix LCD and a 3-hour battery. The color screen can display 256 simultaneous colors at the standard VGA resolution of 640 by 480 pixels. With an 80-MB hard drive, the price is \$7699.

The winner of the Best System Award is the new Z-Note family of notebooks from Zenith Data Systems (see photo 1). Each unit includes an Intel 386SL processor, nickel-hydride batteries, and an Ethernet network connector. The notebooks range from the Z-Note 320 Model 60 (with a 10-inch monochrome LCD, a 20-MHz 386SL, and a 60-MB hard drive; it weighs just under 6 pounds and costs \$3599) to the Z-Note 325Lc Model 120



Photo 1: The Zenith Z-Note family of notebooks received the Best System and Best of Show Awards. Included in the family is a 6½-pound notebook with an active-matrix color LCD.

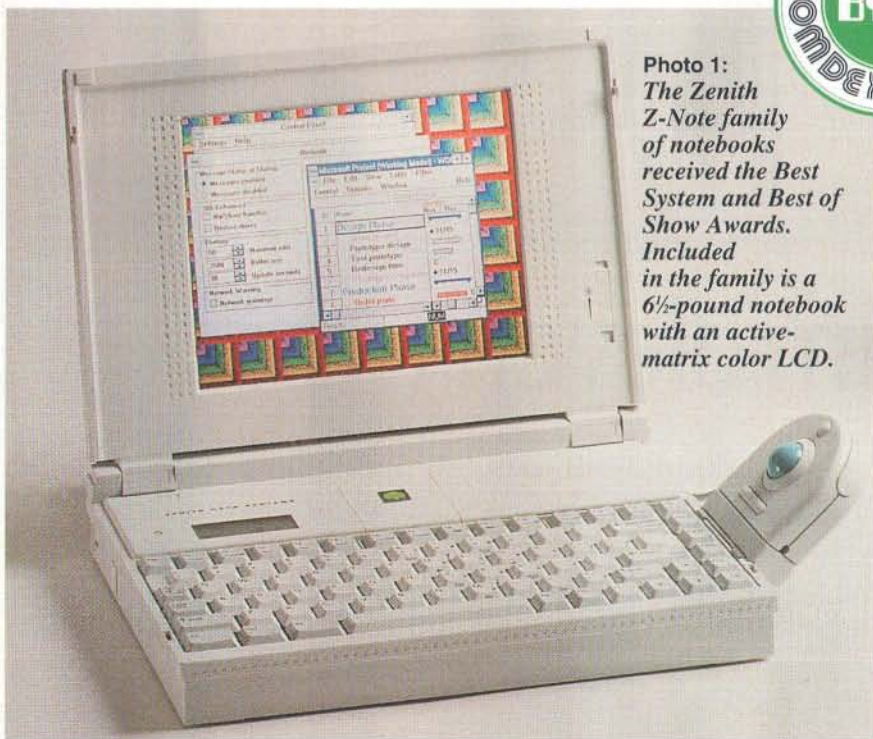

(with a 25-MHz 386SL, a 120-MB hard drive, and a 9-inch active-matrix color LCD; it weighs 6½ pounds and costs \$7299). One of the nice features of these systems is their expandability.

Best Peripheral

One finalist for Best Peripheral Award is the amazing CJ10 color copier/scanner/printer from Canon. This device uses Canon's Bubble-Jet technology to print striking color images at a resolution of 400 dots per inch. As a copier, it can copy a page in about 90 seconds at a cost of less than 60 cents per page. It can also function as a 400-dpi color scanner and a color printer. The price will be less than \$10,000.

Another finalist is a high-end multimedia product: Studio from Matrox Electronic Systems. This set of five EISA cards turns an MS-DOS system into a broadcast-quality video-editing facility. The price is relatively high, \$10,000 to \$16,000, but it's still only a fraction of the cost of equivalent video equipment.

The Best Peripheral Award went to what is probably the first ecologically correct printer: the Ecosys aSi from Kyocera Electronics. This small-footprint LED printer is Hewlett-Packard-compatible and can print 10 pages per minute at a resolution of 300 dpi. But its most fascinating component is its print drum, the surface of which is a layer of amorphous silicon. The toner is

packaged in a biodegradable container made from kelp. Printing costs are less than 1 cent per page. The company claims that over the lifetime of the printer, the cost savings will pay for the printer itself, which costs \$2395.

Best Rookie

One of the finalists for Best Rookie is a longtime veteran of the high-fidelity market, but a newcomer to computers. The company is Altec Lansing, which was introducing its Multimedia computer speakers. These speakers have a unique folding design and an incredible sound. The price starts at \$300.

Another finalist for Best Rookie is

DeltaPoint, for its \$495 graphing package called DeltaGraph Professional for Windows. This new arrival from the Mac world lets you easily create an assortment of business and scientific charts.

The Best Rookie Award went to a German company called Fast Electronic for its Video Machine, a multimedia expansion board that will be available in September for 386-based PC clones and Apple Mac IIs. By inserting the \$4000 Video Machine into a computer and adding two VCRs, you will have a full broadcast-quality video editing and mixing system.

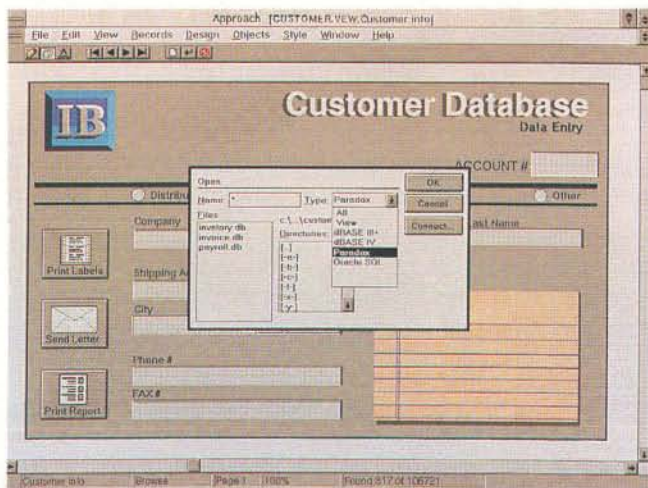

Photo 2: The Best Software Award went to Approach for Windows, which lets you easily create a relational database.

The Best of the Best

The winner of the Best of Show Award was the Z-Note family of notebooks. We liked the built-in networking capability, the lightweight active-matrix color screen, and the expandability. Yes, we had seen some impressive notebooks from other companies, but the Z-Notes looked like the best notebooks—and also the best product overall.

Our congratulations go to the finalists and winners. But the real winners are you, the people who will soon have access to these new products. ■

Rich Malloy is an executive editor for BYTE in New York. He can be reached on BIX as "rmalloy" and on MCI Mail at #306-6564.

THE FACTS

Approach for Windows

Approach Software
(415) 306-7890

Circle 1201 on Inquiry Card.

CJ10

Canon U.S.A., Inc.
(800) 848-4123

Circle 1202 on Inquiry Card.

DeltaGraph Professional for Windows

DeltaPoint
(408) 648-4000

Circle 1203 on Inquiry Card.

Ecosys aSi

Kyocera Electronics
(908) 560-3400

Circle 1204 on Inquiry Card.

Multimedia

Altec Lansing
(800) 258-3288

Circle 1205 on Inquiry Card.

Outside In for Windows

Systems Compatibility Corp.
(312) 329-0700

Circle 1206 on Inquiry Card.

Rooms for Windows

XSoft
(800) 626-6775

Circle 1207 on Inquiry Card.

Studio

Matrox Electronic Systems
(514) 685-2630

Circle 1208 on Inquiry Card.

T386SX

Librex Computer Systems
(800) 248-4880

Circle 1209 on Inquiry Card.

T4400SX

Toshiba America Information
Systems, Inc.

(800) 334-3445

Circle 1210 on Inquiry Card.

Video Machine

Fast Electronic U.S., Inc.
(508) 655-3278

Circle 1211 on Inquiry Card.

Z-Note

Zenith Data Systems
(800) 553-0331

Circle 1212 on Inquiry Card.

WHAT GOOD IS POW



Power /Speed
Caps Lock
Over- lay
Num Lock

ER WITHOUT VISION?

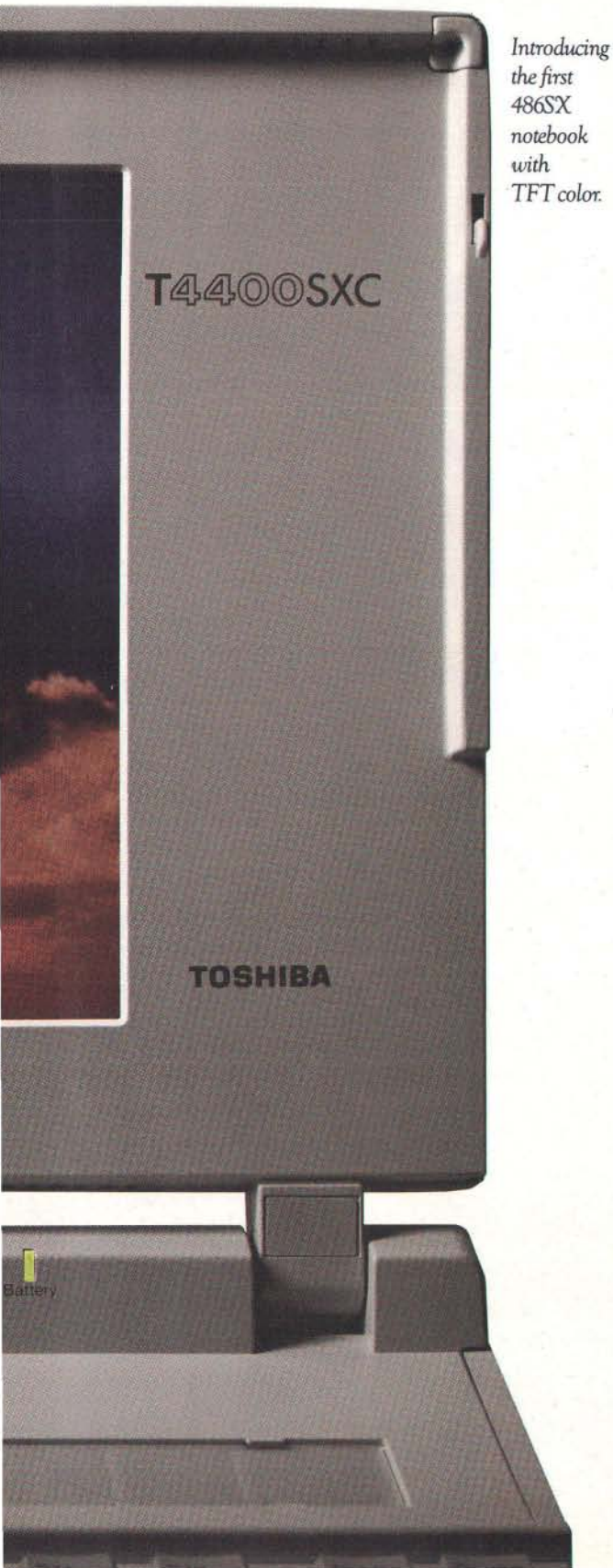

Introducing
the first
486SX
notebook
with
TFT color.

You are about to witness an incredible display of power. Introducing the Toshiba T4400SXC. The first notebook to offer you all the power of a 486SX with all of the jaw-dropping possibilities of TFT LCD active matrix color.

Consider that with its active matrix Super VGA color screen, the T4400SXC can actually display a kaleidoscope of 256 simultaneous colors at a 640 x 480 pixel resolution.

Remarkably, these 256 colors can be drawn from a palette of 185,000 colors to give life to photographic images and color intensive presentations. It's enough to make your retina want to take a vacation.



Not to mention that each pixel on the screen is controlled by three individual transistors, ensuring perfect focus and color registration. The result is amazing clarity far superior to desktop monitors and a brighter, faster screen that far exceeds passive matrix LCD color screens.

Combined with a blazing 25MHz, 486SX microprocessor and 8K internal cache, it's powerful enough to handle your wildest visions.

Of course, you shouldn't be limited by the number of ideas you have either. Which is why the T4400SXC is equipped with a 120MB hard drive for plenty of storage. And 4MB of RAM expandable to 20MB.

And since ideas happen anywhere, any time, we've designed it to fit in half of a briefcase and given it a Nickel Cadmium battery that lasts 3 hours per charge.

Of course, there are times like payday when it is necessary for you to be in the office. Which is why we made our new notebook to be expandable with our Deskstation IV, giving you two expansion slots, and ports for external monitor and external keyboard.

Naturally, this is all just the tip of the iceberg, so call us at 1-800-457-7777 for more information.

We think you'll find that when it comes to the future of personal computing, Toshiba has incredible vision.



In Touch with Tomorrow
TOSHIBA

© 1992 Toshiba America Information Systems, Inc. The Intel Inside logo is a trademark of Intel Corporation.

Circle 167 on Inquiry Card.

A 66-MHz Executive Jet

JOHN W. DONOVAN

HP teams a double-speed 486 with a local bus for supersonic performance

sometime this fall. In the meantime, you can buy a Vectra equipped with a 25-, 33-, or 50-MHz (clock-doubled) processor.

For those who buy now, HP is offering an unbeatable deal. If you purchase a Vectra 486DX2-25/50 before September 1, you will receive a certificate for a free 486DX2-33/66 processor upgrade.

The Sum of Its Parts

While the 66-MHz processor is the media star of the Vectra 486u, as processor speeds pour on the afterburners, it's necessary to make some major changes in the rest of the system. A quiet revolution has been brewing recently in systems design. Engineers are breaking through the performance barrier imposed by ISA and

I'll get right to the point. Hewlett-Packard's expandable EISA Vectra 486u is the fastest system we've tested in the BYTE Lab (see the table). The system I looked at was equipped with one of the first preproduction versions of Intel's groundbreaking 66-MHz DX2 processor. You won't be able to buy a 66-MHz Vectra until the chips become available in quantity, probably

EISA system buses, which are far too slow to allow fast processors to hit their stride.

Enter the *local bus*, which can deliver the performance potential of 25- and 33-MHz 486 systems. Because it operates at three to four times the rate of a system bus and avoids the overhead of bus arbitration, the local bus delivers much greater throughput than your typical I/O bus.

When you add Intel's clock-doubled CPUs (see "Intel's Double-Fast CPUs," May BYTE) to local-bus technology, the bottom line is groundbreaking performance at surprisingly reasonable prices. Even though HP uses the "Jet" moniker only for its laser printers, I couldn't help but think "Executive Jet" as I tested this early model of the Vectra 486u. Coupling two breakthroughs in one system, the Vectra 486u is a clean-slate design aimed at delivering performance, simplifying upgrades, and streamlining system administration.

A Path to the Future

The Vectra 486u's upgrading provisions start with a motherboard built around a local bus that can run at 25 or 33 MHz. With these speeds, most 486 processors (except the 50-MHz 486DX) can enjoy the substantial performance benefits of *fast* communications with key functions. The current selection of processors includes the 486SX at 25 MHz, the 486DX at 25 and 33 MHz, and the clock-doubled 486DX2 at 25/50 and 33/66 MHz.

But there's more. A socket next to the CPU implements Intel's *overdrive* scheme, letting you use Intel's user-installed upgrade processors like the 487SX.

continued



◀ Photo 1: The Vectra 486u works at jet speed using Intel's clock-doubling processor and the local bus.

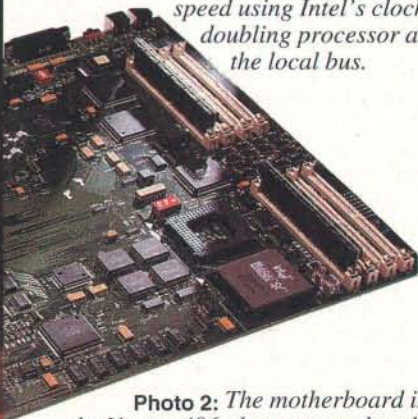

Photo 2: The motherboard in the Vectra 486u has a second socket to implement Intel's overdrive scheme.

PRELIMINARY LOW-LEVEL BENCHMARKS

I ran BYTE's low-level benchmarks on the prerelease Vectra 486u system with three different processors, which showed the effects of upgrading a system's processor and speeding up its internal communications. The Sieve, Sort, Integer Math, Floating-Point Math, and Fourier tests clearly show the results of increasing the 486's internal speed from 33 MHz to 50 and 66 MHz. At 50 MHz, the figures for the DX2 are essentially identical to the results for a full 50-MHz 486DX. At 66 MHz, the results far outstrip those of any 50-MHz 486. Similarly, the results of the Move tests show the effects of boosting the speed of the local bus from 25 to 33 MHz.

	486DX2-33/66	486DX2-25/50	486DX-33
CPU tests			
Sieve	200.20	150.14	115.11
Sort	23.87	17.92	12.18
Integer Math	980,236.58	735,121.94	512,733.10
Move (byte)	149.77	112.22	149.75
Move (word-odd)	199.61	149.56	180.35
Move (word-even)	299.38	224.30	299.31
Move (Dword-odd)	299.28	224.23	234.53
Move (Dword-even)	598.43	448.17	579.01
FPU tests			
Fmath	497,516.60	373,115.96	248,752.78
Fourier	8.49	6.37	4.24

Tests are measured in iterations per second. Higher numbers indicate better performance.

HP has obviously put a great deal of thought into making the upgrade process as painless as possible. The Vectra 486u circuitry automatically sensed which processor/memory configuration I'd installed.

Built for Speed

The pieces of the Vectra 486u are designed and integrated for fast computing. HP's implementation of the local bus connects the CPU (through a 128-KB write-through cache) to up to 64 MB of page-interleaved memory, a fast graphics accelerator, a controller for the five-slot EISA bus, and the system's peripheral controller.

How fast does the local bus operate? Whether or not it's the fast express line is determined by the external speed of the processor. For example, the clock-doubled 486DX2-25/50 calls for the local bus to operate at 25 MHz, while the 486DX-33 and the 486DX2-33/66 increase the speed to 33 MHz. The combination of a choice of processors and two bus speeds provides a unique chance to see how these key determinants of system performance interact (see the table).

On the graphics side, speed is boosted by a fast graphics accelerator card with up

to 1 MB of VRAM (video RAM). Operating at a 70- or 72-Hz refresh rate at resolutions of up to 1024 by 768 pixels and with up to 256 colors, the video subsystem comes with enhanced-mode drivers for Windows, AutoCAD, and a dozen other applications.

Built for Comfort

The 486u system I previewed bore all the marks of thoughtful design and thorough engineering that HP is known for. For example, I configured the system to stand horizontally or vertically by repositioning the front control panel (and nameplate), and I removed the case without the use of tools in a matter of seconds. Inside the system, I had fast access to all the major components—which gave me the ability to upgrade the processor in under a minute.

HP's careful attention to thermal management, including a variable-speed fan that adjusts to the system's internal temperature, ensures reliability. While benchmarking the system, I made measurements of the CPU's operating temperature that testified to the effectiveness of the design. The 486DX-33 measured a cool 92°F, and the 486DX2-25/50 ran at 110°F, both con-

servatively within their rated operating ranges. The 486DX2-33/66 was supplied with an impressively large heat sink bonded to its package. Given the measured temperature of the 50-MHz version, it's not clear that the heat sink is necessary, but it's a further indication of conservative engineering. This system is built to last.

Simplifying System Management

The system even speaks English. The Vectra 486u's designers have replaced the cryptic diagnostic messages of most personal computers with a ROM-resident diagnostics and troubleshooting utility. Failures detected on power-up are displayed with a list of recommended actions. The HPView diagnostics utility lets you call up displays of system configurations and internal settings. Automatic configuration lets you easily add EISA boards.

Security hasn't been forgotten, either. You can access the system only by using HP's password-control procedure at start-up or by pushing a keyboard lock button. Further security provisions let you lock out access to some disks and ports or set the floppy drive to read-only.

The Vectra 486u should be shipping as you read this in all but its 66-MHz DX2 version. If you're considering buying one, I recommend opting for the 50-MHz version now. The free upgrade to a 66-MHz engine is too good a deal to pass up. ■

John W. Donovan is a technical editor with BYTE. He can be reached on BIX as "jwd."

THE FACTS

Vectra 486u

The minimum configuration includes 4 MB of RAM, a 52-MB hard drive, and 512 KB of VRAM. With a 25-MHz 486SX, the price starts at \$2999; with a 33-MHz 486DX, it starts at \$3499; and with the 25-/50-MHz DX2, it begins at \$4199.

Hewlett-Packard Co.

Personal Computer Group
974 East Arques Ave.
Sunnyvale, CA 94086
(408) 746-5000
fax: (408) 746-5520

Circle 1200 on Inquiry Card.

We couldn't say it better ourselves:



Vermont Views v.3.0 Vermont Creative Software

For years, the folks at Vermont Creative have been known for providing one of the most comprehensive character-based interfaces available. Consider that the previous release of this product came with 13 pounds of documentation! Over and above this remarkable attention to programmer needs was a universally admired interface that could do more with character-based interfaces than most people would want to do with graphical user interfaces.

Version 3.0 lives up to this reputation. The library now stretches to nearly 600 functions, explained in three stout manuals that total over 2,000 pages. The new version sports an interactive screen and forms designs whose output can be loaded directly by the application or serve as input to a bundled C code generator. The library has deepened its capabilities to edit data as it is input, continued to add functionality to windowing capabilities, and finally added mouse support, the one feature it previously lacked.

Also bundled with the package is shrouded source code, so you can recompile the libraries for other compilers. Commented, human-readable code is available separately and is a model of self-documenting code—the way libraries should be written but rarely are.

The wide scope of the library, its portability (to UNIX), the extraordinary quality of the implementation, and its stunning documentation (accompanied by 90 sample programs), along with the design tools and code generator, make Vermont Views the first choice among high-end packages for character-based interfaces.

—Andrew Binstock
(Editor, Unix Review)

"And the Winner is . . ."

Computer Language April, 1992

Vermont Views®
Portable user-interface
development
for DOS, UNIX,
POSIX, VMS . . .

Test drive
the 1st choice
yourself.

Call for your
FREE demo kit!

800-848-1248 US & Can.
(Please mention "Offer #308")



Vermont
Creative
Software

Pinnacle Meadows
Richford, VT USA 05476
(802) 848-7731 fax:(802) 848-3502

Circle 172 on Inquiry

Sources of Energy

tura Sco

Shuttle



TEXAS INSTRUMENTS

Dear Customer:

TEXAS INSTRUMENTS
microLaser XL Turbo

Control panel with a small display screen and several buttons labeled: Up, Down, Cancel, and others.

LETTER
LEGAL

Get more work out of your network.

The TI microLaser™ XL Turbo printer.

Now network users can get their hands on high-quality, high-volume documents, fast and affordably. The new TI microLaser XL Turbo runs up to sixteen-pages-per-minute fast, thanks to a Turbo-charged RISC-based controller. And at only \$3,649* – including both 35-font PostScript® Level 2 software from Adobe®  POSTSCRIPT® and HP LaserJet® emulation – it'll accommodate almost any budget.

A member of the award-winning microLaser family, this network printer produces high-quality output in the most graphics-intensive applications. It even switches between PostScript and HP LaserJet modes automatically.

For added flexibility, the microLaser XL Turbo also supports the most popular PC platforms, handling DOS®, Mac®, UNIX® and OS/2® interfaces concurrently**. But there's so much more – versatile paper handling, small footprint and user-installable upgrades, just to name a few.

Buy a microLaser XL Turbo by June 30, 1992, and get a free copy of Adobe Type Manager (ATM) software and Adobe Garamond Font package (total retail value of \$346)! You pay just \$7.50 shipping and handling charge.

See the microLaser XL Turbo in action. Call for the name of a reseller near you. 1-800-527-3500.

 **TEXAS
INSTRUMENTS**

© 1992 TI 71889

*TI suggested retail price – dealer prices may vary.
microLaser is a trademark of Texas Instruments Incorporated. HP LaserJet is a registered trademark of Hewlett-Packard, Inc. Adobe, PostScript and the PostScript logo are registered trademarks of Adobe Systems, Inc. DOS is a registered trademark of Microsoft Corporation. Mac is a registered trademark of Apple Computer, Inc. UNIX is a registered trademark of AT&T. OS/2 is a registered trademark of IBM.

**Maximum of Mac plus two other concurrent interfaces at any one time.

Circle 165 on Inquiry Card.

PaperWorks Makes Paper Intelligent

Imagine the lightest, smallest portable computer possible. It weighs in at a fraction of an ounce, uses no electrical power, and is as thin as a piece of paper. In fact, it is a piece of paper. Farfetched? Not at all. Thinking of a piece of paper as a computer (actually a computer interface) is the very concept behind **PaperWorks**, the latest technology from Xerox PARC (Palo Alto Research Center), that illustrious think tank that's been the birthplace of many of the computer technologies we take for granted today.

The concepts behind PaperWorks sound simple at first, but they hide a rich set of features, numerous new patents, and the beginning of a flood of upcoming products. You install PaperWorks software in a PC (at least a 386 with 4 MB of RAM) equipped with Windows and a send/receive fax card. You can then control your PC from any fax machine, anywhere.

A few examples are in order. With PaperWorks installed on my PC in Peterborough, and access to a fax machine from my hotel in San Francisco, I can have my computer send me a list of faxes I've received while I've been traveling. I can then send a fax requesting that any or all of the faxes be forwarded to my hotel's fax machine.

But that's not all. Let's say I have a fax that I need to send to several locations. I can send PaperWorks the fax I want to distribute, with a list of the people I want it distributed to. PaperWorks takes care of it all.

Often when I'm traveling, I gather notes and releases that I won't be able to use until I return to the office. I could, of course, carry it all back with me. With PaperWorks, however, I can fax the documents back to my computer and have them ready and waiting for me when I return.

There have also been numerous times when I've been traveling and found I've left an important document at the office. PaperWorks will fax the document to me, at any hour, without human intervention back at the office.

Essentially, PaperWorks turns my office PC into a document storage and information center. The applications are virtually unlimited. The key to using Pa-

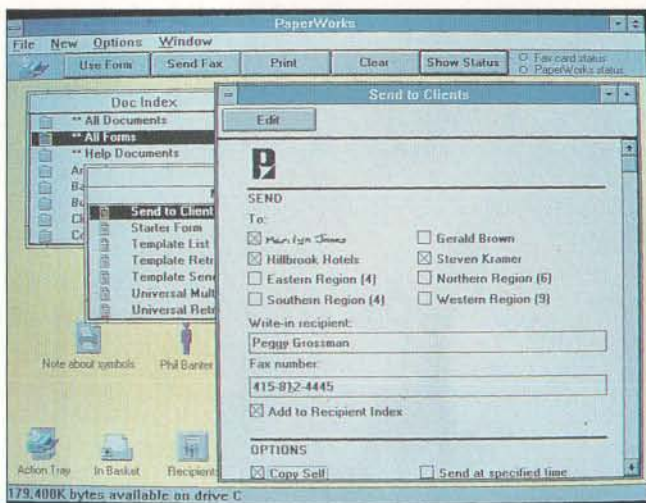

perWorks is a set of forms that Xerox calls SmartPaper. There are various forms for sending, retrieving, and storing documents. If you need more forms, you just make a copy.

"Aha," you say. "What if I forget to take the forms with me?" No problem. All you do is fax your PaperWorks-equipped PC a blank sheet of paper. It will fax you back a "universal multipurpose form" that will let you perform any PaperWorks function.

PaperWorks has multiple levels of security. Each PaperWorks package has forms that have a unique identification that's virtually impossible to forge. Your system will recognize only those forms. (There are other levels of protection too extensive to go into here.)

Although PaperWorks uses its own intelligent character recognition to read some information on its forms, its forte is dealing with *images* of documents, essentially large graphics files. That's not as limiting as it sounds. PARC's teams of "social anthropologists" spent a great deal of time studying the way people work with documents while in the office and while traveling. Their conclusions aren't really surprising: Most documents start as paper and end up as paper. In the interim steps, they are also handled as paper images. This is where PaperWorks shines.

But it doesn't end there. PARC scientists tell us that PaperWorks is only the first in a series of PaperWare products that will be introduced in the next few years. It's a safe bet that future PaperWare products will make good use of PARC's new patents for the computerized handling of text.

Currently, PaperWorks requires one of

four generally available fax boards: Intel's Satisfaction, The Complete PC's The Complete Fax or The Complete Communicator, or Singapore Technology's CEI proFax. Xerox says other fax boards will be added to the list in the near future.

Installing PaperWorks is easy, although the more information you give it at the beginning (e.g., a distribution list of people you regularly send faxes to), the easier it will be to use the software. (You can easily add other names later, locally or remotely via fax.)

When you're not traveling, PaperWorks is a first-class local fax system and document management system for your PC. The interface, although it's Windows based, is unique and uses Windows graphics to maximum advantage. Handy drag-and-drop features make the chore of managing faxes and documents much easier than the plain-vanilla Windows file manager.

PaperWorks made me do a lot of hard thinking about how I interact with my computer and my data. Ironically, it puts another nail in the coffin of the paperless office by adding more paper. But useful paper it is, indeed. PaperWorks is one of the most innovative, useful, and unique products I've seen. It goes a long way toward consummating the marriage between PC and fax.

—Stan Miastkowski

THE FACTS

PaperWorks
\$249.99

System requirements:
IBM PC, PS/2, or compatible with at least a 386 processor, 4 MB of RAM, Windows 3.0, and a send/receive fax card.

XSoft
Xerox Corp.
3400 Hillview Ave.
Palo Alto, CA 94304
(800) 432-9329
fax: (800) 428-3329

Circle 1194 on Inquiry Card.

The 386SX with the lowest cost upgrade.

See us at
PC EXPO
booth #4052



The One & Only

Acer is the only company that lets you upgrade your 386SX computer to a 486 using a single chip. Others ask you to buy an upgrade module, costing \$500-\$1,000.

Four Times the Power

Other PCs let you double your CPU clock speed. But that's all. With the unique

Acer CPU upgrade technology, you can get up to four times your processing power.

The Lowest Cost

There is a lot of talk about upgrades... but the facts are that this AcerPower 386SX allows the lowest cost CPU upgrade on the market.

Get Yours Now!

With AcerPower 386SX, you get 2MB RAM and a 125MB hard drive.



	<i>Upgrade</i>	<i>Cost</i>
Acer	Plug in a Chip	\$175.00
Other	Replace a Modular Board	\$500.00

The Easiest Move

To upgrade, just remove the cover, snap in the chip, replace the cover and turn on the power. Your 386SX automatically detects the new CPU to become a full-function 486 computer. All for the price of an Intel CPU chip, available from any electronics or computer store.

Acer. Giving you the power you need tomorrow, today. For more information and your free upgrade brochure, "Protecting Your Computer Investment: A Buyer's Guide to Upgradability", call us today at 1-800-SEE-ACER!

**"The AcerPower 386SX...
boasts the least expensive
upgrade trick yet."**

PC World, January, 1992

1-800-SEE-ACER
US and CANADA

Acer America Corporation
2641 Orchard Parkway
San Jose, CA 95134



Acer and the Acer Logo are registered trademarks of Acer Incorporated and Acer America Corporation. The Intel Inside Logo and 486 are trademarks of Intel Corporation.

Circle 71 on Inquiry Card (RESELLERS: 72).

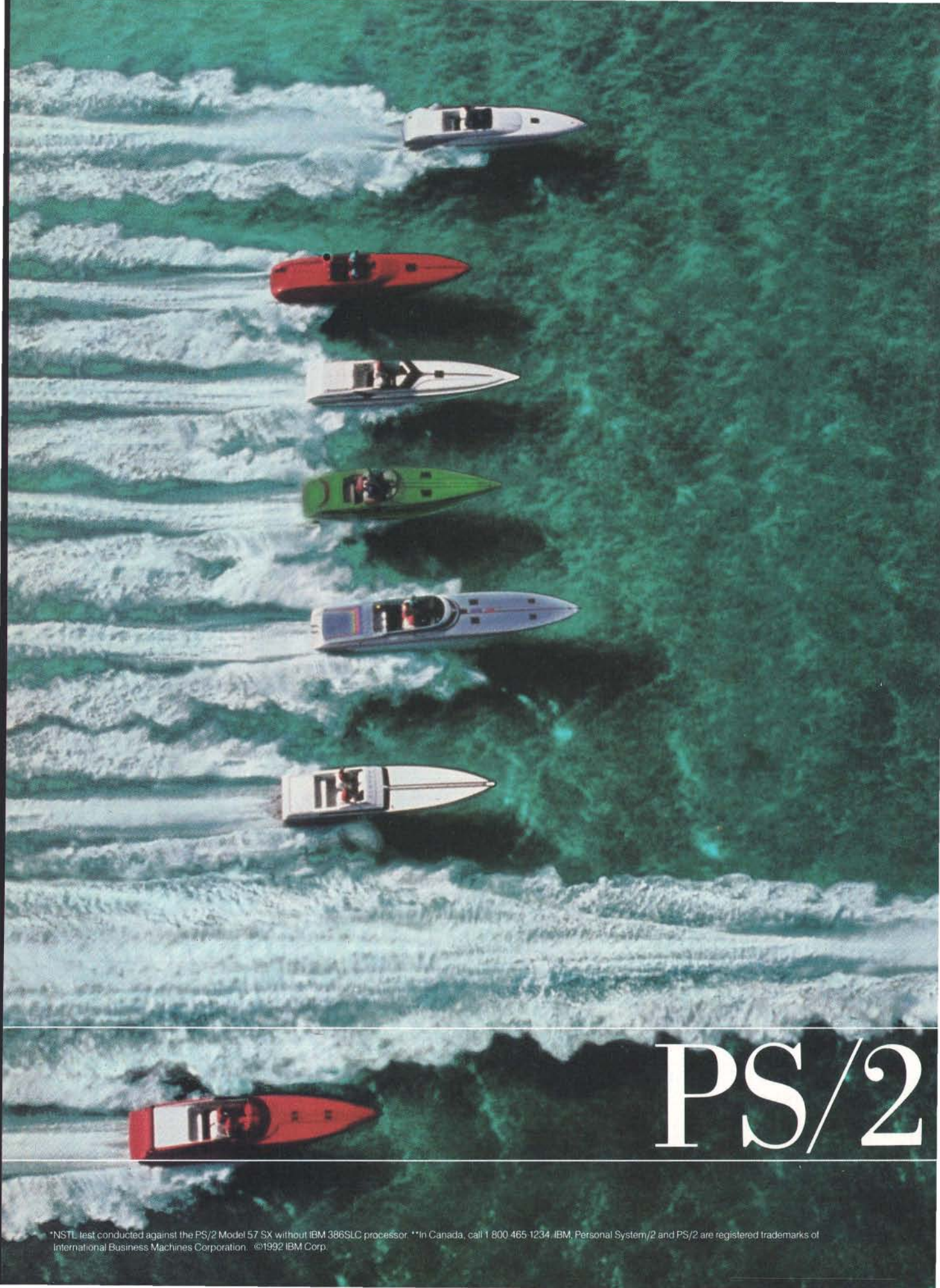

PS/2

*NSTL test conducted against the PS/2 Model 57 SX without IBM 386SLC processor. **In Canada, call 1 800 465 1234. IBM, Personal System/2 and PS/2 are registered trademarks of International Business Machines Corporation. ©1992 IBM Corp.

It blows everything else out of the water.

With our new IBM 386SLC processor, the new PS/2® Models 56 and 57 SLC are really making waves. They're faster than any 386 SX computer you can buy—up to 88% faster, to be precise.* They're even faster than most 386 DX systems.

Both models are completely upgradable, to help protect your investment. They're also completely compatible with your existing hardware and software. So in stand-alone or connected environments, about the only thing that changes is how much faster you can get things done.

The new Personal System/2® Models 56 and 57 with IBM 386SLC processor. So fast, you could say other computer companies have missed the boat. For more information, see your IBM authorized dealer. For the dealer nearest you, call 1 800 942-4-IBM, ext. 386.**

Introducing SLC in the new PS/2 Models 56 & 57.

- Faster than any 386 SX computer you can buy.
- Faster than most 386 DX computers.
- New 386SLC processor with 8K internal cache.
- 4MB memory, 80 or 160MB hard drive, up to five slots/four bays.
- Supports 3.5" and 5.25" diskette drives.



Circle 108 on Inquiry Card.

IBM®

HP's Desktop and Application Integration Solution for Windows

Hewlett-Packard has added some sparkle to **NewWave 4.0**, and the object-oriented environment remains full of features that are not available in one package anywhere else. With the introduction of Windows 3.1, Microsoft took a little of the splash of NewWave away by improving OLE (Object Linking and Embedding) and by improving its own desktop and overall operation. Nevertheless, the look and feel of NewWave 4.0 is subtly different from that of Windows, with more of a three-dimensional feel and the use of icons for more functions (e.g., an Apple-like trashcan icon). Also, windows in NewWave open and close with a zoom motion that gives the process more of an interactive feel than is present in Windows.

HP is repositioning NewWave in the market as a desktop manager, after it discovered that most of its customers thought of NewWave in that way. A feature that users particularly like is the ability to use 32-character filenames, eliminating obscure filenames like tx6-91.wks and replacing them with names like Company Taxes June 1991. Version 4.0 lets all files and folders of any type have full 32-character names.

NewWave uses a completely object-oriented metaphor for working with files and data. All files and folders are objects with attached attributes. These objects can be linked to application objects. Thus, clicking on a file will automatically launch the appropriate application. In NewWave 4.0, the object metaphor has been extended to include a drag-and-drop capability. If the icon for Company Taxes June 1991 is dropped onto the printer icon, it is automatically printed appropriately.

HP has improved desktop operation in other ways by adding full OLE 1.0 compatibility, the ability to attach files by dragging and dropping them into NewWave, and a powerful object finder that can find any object from among thousands in under a second. The enhanced software installation process in NewWave 4.0 provides a new interoperability between NewWave and DOS and Windows applications. Now, the applications are automatically available as icons on the desktop after you have installed NewWave.



Despite this emphasis on the desktop metaphor, I find NewWave most useful in the area of work automation. NewWave includes the concept of *agents*. These are software programs or macros that automate everyday tasks you perform on your computer. Typically, you create agents by example: You show the agent how you normally perform the task. The agent learns from your example and is ready to perform the task automatically, either when you tell it to do so or at scheduled intervals—or even when it's triggered by other events.

In NewWave 4.0, HP has dramatically enhanced its agents. In addition to including support for DDE, NewWave now has the ability to call DLLs to link with external programs, record and play back menu selections rather than just keystrokes, call other agents to chain tasks, be triggered by external events, and support arrays and pointers. All these features make agents far more powerful. HP didn't stop there. It also has added a visual tool, called an interface object, for building dialog-box interfaces to agents with programmable push buttons and I/O fields. In addition to push buttons, the boxes can contain text, check boxes, radio buttons, icons, edit fields, and list boxes. You can use the visual interface to create your own interface to acquire and display information.

HP includes some sample agents to help get you started, but it could do better in this important area. Although creating agents by example is useful for many tasks, to move beyond that and have agents call one another and work together, you must start programming the agents using the

built-in control language. More examples in the desktop manager would help newer users get started. Despite this single minor flaw, HP's agents are far superior to the macro capabilities of other desktop and integration programs. This capability is what truly sets NewWave apart.

HP even managed to improve installation by automatically detecting and attaching applications. NewWave 4.0 also requires less disk space than the previous version. HP accomplished this by removing NewWave Write (which seemed to be getting little use) and eliminating operation under Windows real mode.

A few things are still missing in NewWave 4.0. It needs to operate better in a network environment, something that HP is working on. It needs to integrate fully into OLE 2.0, another area where HP is at work. Currently, you cannot install NewWave as the default desktop, replacing the program manager. As of now, this makes sense for NewWave. But if HP really wants its product to be a Windows desktop, it must improve its capabilities in these areas.

Despite these shortcomings, it is hard to beat NewWave for automating work under Windows and for making Windows easy to use. We'll just have to wait for NewWave 5.0 to wash up on the shore to smooth out the final ridges in the sand.

—Owen Linderholm

THE FACTS

NewWave 4.0
\$195

System requirements:
Windows system with 2 MB of extended memory and 10 MB of disk space.

Hewlett-Packard Co.
3000 Hanover St.
Palo Alto, CA 94303
(800) 525-9283
(415) 857-1501

Circle 1195 on Inquiry Card.

Programmer's Paradise[®]

CALL

BKS SOFTWARE

POET	CALL
BORLAND	
Borland C++	325
& Application Frameworks	509
ObjectVision 2.0	105
Paradox 3.5	525
Turbo C++	69
For Windows	109
Turbo Debugger & Tools	105
Turbo Pascal 6.0	105
Turbo Pascal Pro 6.0	209
Turbo Pascal for Windows	175
World of C++ Video	95

MICROSOFT

MS BASIC Prof. Devel. Sys.	349
MS C/C++ 7.0	299
MS C/C++ Comp. Upgrade	134
MS COBOL	629
MS FORTRAN	349
MS Macro Assembler	105
MS Office for Windows	499
MS OS/2	
Present. Mgr. Softset	105
MS Pascal	209
MS QuickBASIC	69
MS QuickC for Windows	139
MS Test	275
MS Visual Basic	139
w/Prof. Toolkit	239

SOFTWARE QUALITY AUTO.

SQA: Manager	979
SQA: Robot	479

SOLUTION SYSTEMS

BRIEF	CALL
BRIEF & dBRIEF	CALL
C-Worthy	399
CHARGE	89
Sourcerer's Apprentice	455

SOUTH MOUNTAIN

SOFTWARE

Breakout II	189
C Utility Library	199
Essential B-Tree	159
Essential Communications	259
Essential Graphics Chart	149
Essential Graphics GUI	105
Essential Graphics Kernel	149
TSRific	79

SYMANTEC

Just Write	179
Norton AntiVirus	99
Norton Backup	99
Norton Commander	99
Norton Desktop f/Windows	109
Norton Editor	85
Norton Utilities 6.0	129
On Target	279
Q&A	265
TimeLine 5.0	475
Zortech C++ Dev. Edition	445
Zortech C++ S&E Edition	659

Distinct TCP/IP for Windows

Gives you TCP/IP connectivity without consuming your DOS memory. Multiple concurrent Telnet sessions, drag and drop file transfer (FTP) and more. You can even drop remote files onto a local printer! Ping and other utilities included. Optional developers toolkit for TCP/IP, RPC, Telnet, FTP and NFS available.



Distinct TCP/IP for Windows Network Applications
List: \$395 Ours: \$349
FAX_{cetera} #2994-0003

Distinct TCP/IP for Windows
List: \$495 Ours: \$429
FAX_{cetera} #2994-0002

dBASE IV 1.5

NEW VERSION! dBASE IV lets you perform data management tasks quickly and easily without having to learn complex programming commands. The Control Center organizes and displays everything you need in order to access and manage your data. No other product helps you organize your files as quickly and easily into meaningful business information.



List: \$795 Ours: \$499
FAX_{cetera} #2660-0001

WATCOM

WATCOM C9.0	429
WATCOM C9.0/386	719
WATCOM FORTRAN 77 8.5	449
WATCOM FORTRAN 77/386	629
WATFOR-77 3.1	335

WHITWATER GROUP

Actor 4.0	219
Actor Professional	445
ObjectGraphics	CALL
WINTRIEVE	339
WRT	CALL

CASEWORKS

CASE-PM for C or C++	1895
CASE-PM for COBOL	2395
CASE-W Corporate Edition	899
CASE-W Knowledgebase	349

MICROSOFT (continued)

MS Visual Basic Comp. Upg. w/Prof. Toolkit	189
MS Windows SDK	349

MORTICE KERN

SYSTEMS

MKS LEX & YACC	197
MKS Programming Platform	539
MKS RCS	149
MKS Toolkit	199

SOFTWARE

BLACKSMITHS

C-DOC	179
C-DOC-Professional	279

Microsoft Visual Basic & Prof. Toolkit

Contains and builds on the Visual Basic 1.0 programming. Adds programming tools and more than 20 powerful controls, resulting in a sophisticated system that gives quick access to charting, multiple document interfaces (MDI), object linking and embedding (OLE), tables, and pen and multimedia capabilities. Additional controls help you create 3-D interface components, design dialog boxes, and include multi-state buttons.



MS Visual Basic w/Prof. Tlkt. List: \$495 Ours: \$239
MS Visual Basic Comp. Upg.w/Tlkt. List: \$398 Ours: \$189
FAX_{cetera} #1269-0037

FAIRCOM

c-tree Plus	489
Faircom SQL Server	409
Faircom Toolbox	899
r-tree	239

GIMPEL SOFTWARE

C Shroud	599
C-terp	229
C-terp 386	269
PC-Lint	105
PC-Lint 386	179

GREENLEAF SOFTWARE

Greenleaf Comm++	159
Greenleaf Comm Library	287
Greenleaf DataWindows	315
Greenleaf Fin. Math Lib.	315
Greenleaf Fin. Math Lib++	159
Greenleaf Functions	179
Greenleaf SuperFunctions	239
Greenleaf ViewComm++	289

INTERSOLV

IVCS Config. Builder	229
IVCS Version Manager	699
IVCS Professional Editor	269



CALL FAX_{cetera}TM
(908) 389-8173
for additional information
on the best selling products!

800-445-7899

The Software Sou

Developers, we're here to serve you. Programmer's Paradise offers the world's largest selection of software development tools and utilities at guaranteed low prices. If you don't see what you want, call us! And don't forget to ask for our free comprehensive catalog.

WindowsMAKER Professional

The fastest way to create Windows applications in C. Generates the Windows .EXE with fully commented source and production files. No royalties. Point and click to define user interface. Preview your design to instantly test look and feel. Make changes on the fly without compiling. Custom code is preserved during code generation. Supports C++. True Visual Programming in C.

List: \$995 Ours: \$695
FAX cetera #2602-0003



386/486 Development

Intel 386/486 C Code Builder	575
Lahey EM/32 5.0	1015
Phar Lap 386/DOS-Extender	439
WATCOM C9.0/386	719
Zortech C++ Devel. 3.0	CALL

Assembly/Disassembly

DIS DOC Professional	209
MS Macro Assembler 6.0	105
Turbo Debugger & Tools	105

Basic

GFA Basic	199
MS Basic PDS	349
Realizer	319
Visual Basic	139
Visual Basic Comp. Upgd.	99
Visual Basic Pro. Tikt. SPECIAL!	99
Visual Basic & Tikt Bundle	CALL

C/C++ Compilers

Borland C++	325
w/ Application Frameworks	509
Microsoft C/C++ 7.0	299
Competitive Upgrade	134
MS QuickC for Windows	139
Turbo C++	69
for Windows	109

C-Application Generators

CASE:W Corporate	899
dANALYST GOLD	99
PRO-C	99
WindowsMAKER Prof.	695

Dan Bricklin's® Demo II™

Experience for yourself why 30,000 people have made Demo II 3.0 the leading tool for producing program prototypes, demonstrations, and tutorials. Demonstrate commercial software to potential customers without shipping live software. Produce effective tutorials that interactively teach products. Create Computer Based Training for a fraction of the cost of dedicated CBT authoring software.

List: \$249 Ours: \$215
FAX cetera #0233-0003



C Communications

BreakOut II	189
C Async Manager	165
C Comm Toolkit	129
Essential Comm	259
Greenleaf CommLib	287
Greenleaf ViewComm	319
QuickComm	119
SilverComm C Async	189

C Screens

C-scape	
C Windows Toolkit 386	
C Worthy w/ source	
Greenleaf Data Windows	
Panel Plus II (DOS & OS/2)	
Vermont Views	
Vitamin C	
QuickWindows Advanced	

WATCOM C 9.0/386

Develop and debug 32-bit applications for extended DOS, Windows, and OS/2 2.0 with the most complete 32-bit C development package available. Includes the royalty-free DOS/4GW DOS extender by Rational Systems, components from MS Windows SDK, compiler, linker, debugger, profiler, plus numerous development tools. Supports other industry standard 32-bit DOS extenders. Create ADS Applications for AutoCAD or embedded systems development.

List: \$895 Ours: \$719
FAX cetera #1683-0001

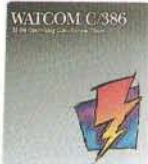

PRODUCT OF THE MONTH:

LAHEY
F77-EM/32 5.0

Industry leading 32-bit Fortran Language System includes Phar Lap's 386/DOS-Extender. This VCPI, XMS, and DPMI compliant extender enables users to access up to 4GB and operate in the MS Windows DOS box. The extender is royalty-free and includes virtual memory support. New with Version 5.0: 32-bit debugger, arrays beyond 16MB, compression linker, and 486 optimizations. Support for popular VAX, IBM VS, and 90 features.

List: \$1195 Ours: \$1015
FAX cetera #1476-0004

C- Additional Products

C-Doc
C-Doc Professional
MKS LEX & YACC
PC Lint
Phar Lap 286/DOS-Extender

C++ Libraries/Utilities

C++Views
Codebase 4.5
Greenleaf Comm++
ObjectGraphics
object-Menu
ObjectPM
Object Professional for C++
Poet
Rogue Wave Math.h++
Rogue Wave Tools.h++
Style
Win++
Zinc 3.0

800-445-7899



International: 908-389-9228
Customer Service: 908-389-9229

Canada: 800-445-7899
Fax: 908-389-9227

CALL US

Paradise for Developers!

Base Development

Am Professional	525
Am	521
Am 3.5	549
E IV	CALL
E IV Devel. Edition	845
o	489
o Distribution Kit	CALL
ox 3.5	525
atabase Library	279
Code Generator	219
Report Writer	219
/what!	45
Clip/Fox SPCS	259

Pascal

Topaz	89
Turbo Pascal for Windows	175
Turbo Pascal Professional	209
Turbo Professional	99
Prototyping	
Dan Bricklin's Demo II	215
Show Partner F/X	355
Version Control	
MKS RCS	CALL
PVCS Config. Builder	209
PVCS Version Mgr (DOS & OS/2)	699
TLJB	109

Utilities

386MAX	85
After Dark	29
Bar Code Library	319
Blue MAX	105
Dr. Switch - ASE	153
HJAAK	174
Hold Everything	159
INSTALIT	135
Label Master	399
MKS Toolkit	199
Norton Anti-Virus	99
Norton Commander	99
Norton Utilities 6.0	129
Opt-Tech Sort/Merge	115
PC Tools Deluxe 7.0	129
SpinRite II SPECIAL!	59
Stork Installation	CALL
SUNSHOW Image Library	CALL

ImageMan™

Puts Images in Your Windows-

ImageMan is the first and only object-oriented Windows library that puts advanced image display and print capabilities in your software. Access any type of image with the same set of standard function calls. Fully supports TIFF, PCX, GIF, EPS, WMF and BMP formats. Use ImageMan with any language that supports calling DLLs: C, C++, Turbo Pascal for Windows, Visual Basic, Smalltalk/V, Actor and many more. Royalty Free.



List: \$395 Ours: \$359
FAXcetera # 3612-0001

Intel 386/486 C Code Builder Kit

Double your DOS application performance. Address 4 gigabytes of memory. The C Code Builder™ V1.1 Kit contains Microsoft- and ANSI-compatible C tools and produces 32-bit applications compatible with DOS, Windows, and OS/2. Compatible with 386MAX, EMM386, QEMM-386, and NETROOM. Works with Microsoft and Borland assemblers. 60-day money-back guarantee. Royalty-free.



List: \$695 Ours: \$575
FAXcetera # 0429-0001

GUARANTEED BEST PRICES*

Should you see one of these products listed at a lower price in another ad in this magazine, **CALL US!** We'll match the price, and still offer our same quality service and support!

Terms of offer:

- * Offer good through June 30, 1992
- * Applicable to pricing on current versions of software listed.
- * June issue prices only
- * Offer does not apply towards obvious errors in competitors' ads.
- * Subject to same terms and conditions

Editors

Am Scope Debuggers	CALL
Am Scope Debuggers	CALL
Am	169
Am	89
Am	139
Am	154
Am	249
Am	149
Am	1015
Am	535
Am	349
Am	449

Windows Development

Actor Professional	445
CASE/W Corporate	899
CODEPAD for Windows SPECIAL!	59
dBFast Windows	395
GFA Basic	249
Magic Fields	CALL
Norton Desktop 2.0 f/ Windows	CALL
ObjectVision	105
RoboHelp	449
Realizer	319
Smalltalk V/Windows	395
ToolBook	329
WindowsMAKER Professional	695
zApp	165

dBFast Windows

The complete stand-alone dBASE/xBASE development language for MS Windows. dBFast lets you create fast, powerful, easy-to-use graphical applications. Design multiple windows, pull-down menus, check boxes, list boxes, radio buttons, bitmap pictures and more. Over 200 extensions to the dBASE III Plus language as well as an interactive editor, compiler, and linker.



List: \$550 Ours: \$395
FAXcetera # 1004-0003

Graphic Libraries

Am	229
Am	259
Am	209
Am	149
Am	269
Am	189
Am	179
Am	179
Am	125
Am	279
Am	279
Am	359
Am	279
Am	85
Am	CALL
Am	179
Am	248
Am	269
Am	335

Phone Orders

Mon-Fri 8:30 AM-7PM EST, Sat 9:30-2:30 EST. We accept MC, Visa, AMEX. Domestic shipments, please add \$5 per item for shipping/handling (UPS ground). Domestic COD shipments, please add \$3. Rush service available.

Mail or FAX / International Orders/ Domestic Purchase Orders Phone number required.

Returns Subject to \$25 processing charge.

FAXcetera (908) 389-8173 Call from your FAX telephone and follow the instructions to receive more information on the products featured above!

Corporate Accounts Call CORSOFT, our corporate sales division. Ask about volume purchase agreements.

* All prices subject to change without notice.

ODAY!

800-445-7899

CORPORATE (CORSOFT): 800 422-6507

Circle 125 on Inquiry Card

CALL 800-445-7899



FrameMaker for Windows: The Powerful Publisher Comes to PCs

Windows users who have been looking for maximum desktop publishing power can call off the hounds: FrameMaker is here. Born under Unix and moved to the Mac, **FrameMaker for Windows** represents a new level of document publishing for PC users.

Although it's geared toward long documents and technical material, FrameMaker can be used to assemble virtually any kind of publication. It's got your basic layout tools, which are frame-based. The modus operandi centers around placing frames—resizable rectangles—on the page and filling them with text, images, tables, and other elements of a publication. You can manipulate frames either graphically—by clicking and dragging and stretching handles—or through dialog boxes, and you have the choice of using the mouse or keyboard for practically every operation.

In addition to layout and design tools, FrameMaker has sophisticated typesetting controls. It's especially adept at setting complex text (e.g., equations and formulas). Like other desktop publishing packages, FrameMaker lets you use style sheets to apply formatting commands to text.

This is as Windows-like an application as you'll find. It doesn't just look and act like a Windows program: It conforms to the more advanced functions of Windows, such as OLE (Object Linking and Embedding) and the multiple-document interface. Like other powerful Windows applications, FrameMaker devours memory. The company calls 4 MB the bottom line but rightly recommends 8 MB. In my tests, the program hummed along pretty well on anything from a 33-MHz 386 on up. On a 20-MHz 386, however, actions like scrolling could get tedious. For WYSIWYG

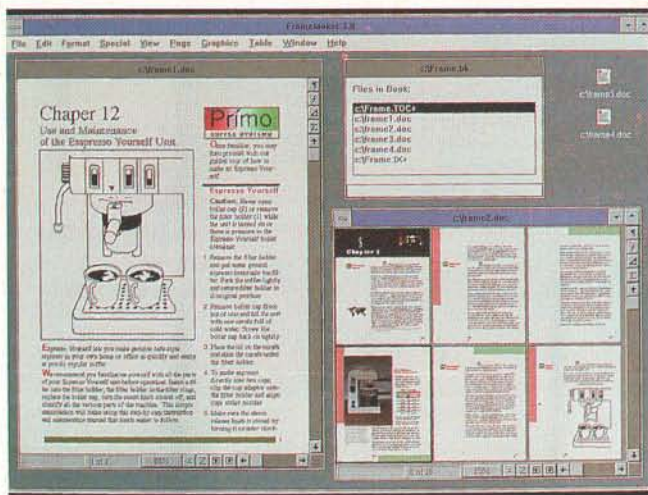

word processing, FrameMaker is quite fast.

Frame Technology has implemented the concept of conditional text. This lets you have one master document that contains a bunch of variations. For example, say you've developed a software product that comes in Windows and Mac versions. Much of the manual will apply to users of both types of machines, but some of it will be specific to just one group of users. You can tag the Mac-specific sections as conditional. When it's time to print the manual for the Windows version, you tell FrameMaker to hide the Mac-specific text. It essentially becomes invisible to the printer. When it's time to print the documents for the Mac version, you turn the conditional switch off.

FrameMaker is an upstanding global citizen. It lets you work with FrameMaker documents from one platform to the next. I've taken Mac FrameMaker files, shipped them across the network, and opened them under Windows. The same transportability applies to the Unix versions. With its stack of import filters, FrameMaker can pull in text and graphics of just about any format.

As we were going to press, Frame Technology still had some big bugs to knock out of this program. I worked with an alpha version, so bugs were to be expected. Most of the functions were operative, but UAEs (unrecoverable applications errors) and other mysteries of the Windows universe were fairly frequent occurrences. Frame Technology is known for solid products, so it's a good bet that FrameMaker for Windows won't ship until it's been shaken down.

FrameMaker's publishing capabilities are reason enough to buy it. Add its cross-platform consciousness, and you can't beat this program. Its ability to co-exist in a mixed-machine environment is one of the wonders of FrameMaker. Any office with a variety of networked computers, with people using a variety of word processors, should seriously consider adopting FrameMaker as its document publishing system. Nothing can match it.

—D. Barker

THE FACTS

FrameMaker for Windows
\$795

System requirements:

A 386 with a minimum of 4 MB of RAM and 10 MB of hard disk storage.

Frame Technology
1010 Rincon Cir.
San Jose, CA 95131
(408) 433-3311
fax: (408) 433-1928

Circle 1196 on Inquiry Card.

Buttoning Up Procomm Plus

Call me skeptical. I've used the DOS version of Procomm Plus since it was shareware. My fingers have become accustomed to its Alt-key commands. I know the dialing directory like the back of my PC compatible. So why would I want a Windows version of Procomm Plus?

Well, to start with, **Procomm Plus for Windows** has an Action Bar, a row of iconic buttons along the top of the window that lets you perform the most common telecommunications functions with a single click: dial, hang up, send and receive files, run scripts, capture incoming text to

a file or printer, scroll back through the previous lines you've sent or received, and change your communications setup. If you have a high-resolution Windows display (i.e., 800 by 600 pixels or higher), you also get buttons that allow you to clear the screen, record scripts automatically,

Now that WordPerfect users prefer Microsoft Word for Windows, we're spreading the Word.

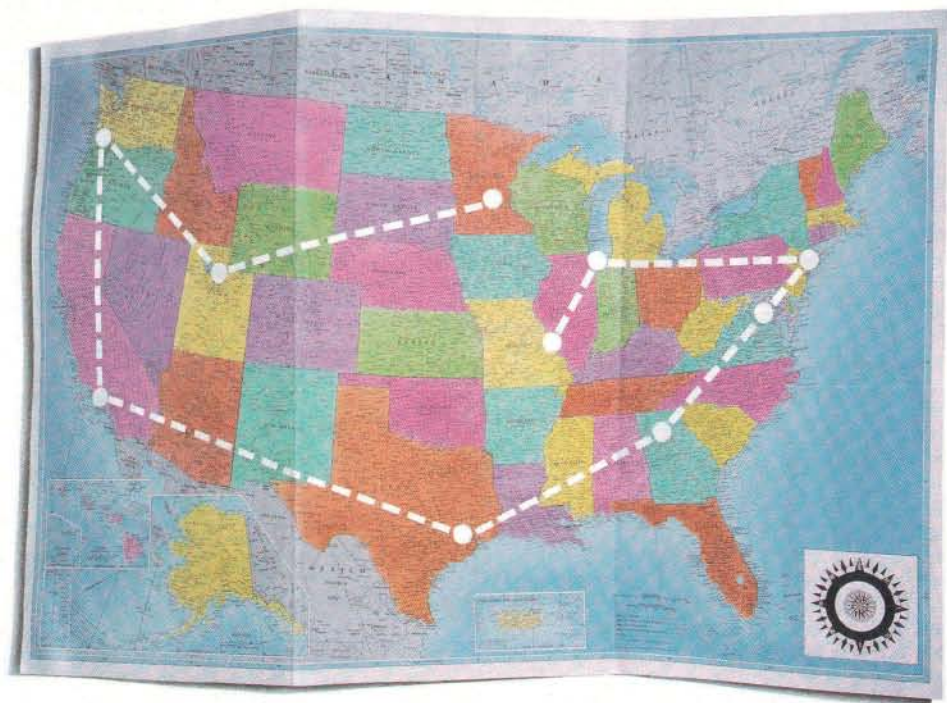

The 1992 Coast-to-Coast Word Challenge.

We're calling it "The Word Challenge." And in the weeks to come, we'll be traveling coast-to-coast testing WordPerfect® for DOS

NSTL TEST RESULTS, DECEMBER 1991

	Word for Windows	WordPerfect for Windows
Preferred to use	79%	21%
Easier to learn	71%	21%
Easier to use	83%	13%
Would purchase	79%	21%

users to find out which word processing program they prefer for everyday word processing tasks.

It started last December when, in a test conducted by the National Software Testing Labs, nearly eight out of 10 WordPerfect for DOS users preferred Word for Windows™ over WordPerfect for Windows.

As excited as we were about the results, we're even more excited about the prospect of finding out if WordPerfect users all over the country feel the same way. So, we're taking

the NSTL show on the road to ten cities. Everywhere from Washington, D.C. and Minneapolis, to Dallas, Salt Lake City and Los Angeles.

Call for a free "Word Challenge Kit." Included is a videocassette highlighting the test, and interviews with WordPerfect users who took the challenge. Also in the kit are the files you need to test Word on your own. Call (800) 323-3577, Department Z49. We think once you judge for yourself, you'll want to take advantage of our special \$129 upgrade offer.* Then, no doubt, you'll end up spreading the word for us.

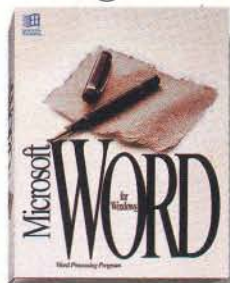

Microsoft
Making it easier

*Offer good for current licensees of WordPerfect, MultiMate, WordStar, MS Word for MS-DOS, and DisplayWrite. Please allow 2-4 weeks for delivery upon receipt of order by Microsoft. Offer expires 6/30/92. Limit one per customer. Reseller prices may vary. Call for system requirements. Offer good only in the 50 United States. To receive only the NSTL test results: In the United States, call (800) 323-3577, Dept. Z49. For information only: In Canada, call (800) 563-9048; outside the U.S. and Canada, call (206) 936-8661. © 1992 Microsoft Corporation. All rights reserved. Printed in the USA. Microsoft and MS-DOS are registered trademarks and Windows is a trademark of Microsoft Corporation. WordPerfect is a registered trademark of WordPerfect Corporation.

Seems like ev missed the bu

NEC's unique local video bus lets you see graphics 200% faster.

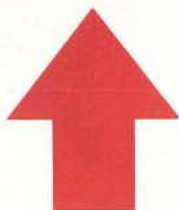

The Image Series was designed to take advantage of NEC's new MultiSync FG monitor line, which includes our FullScan™ technology. It gives you edge-to-edge images in a much larger display area. Combine it with an Image Series PC and you'll not only see your information faster, you'll see more of it.

■ Looking to get to your graphics faster? Well, there's just one thing to do. ■ Catch the bus. ■ NEC's local ImageVideo™ bus. The only local video bus to come standard on a personal computer. Available on the PowerMate® SX/20i and the 386/33i, it's a dedicated path for video data that operates at the same speed as the processor. ■ So you can see your graphics at lightning speeds. More than twice as fast as our closest competitor. Pretty fast for a local bus, wouldn't you say? ■ But our local video bus is just one of many reasons why the Image™ Series personal computers are taking the computer world by storm. ■ There's also our unique, integrated motherboard. It has a microprocessor, state-of-the-art cache and expandable memory built in. That way, with

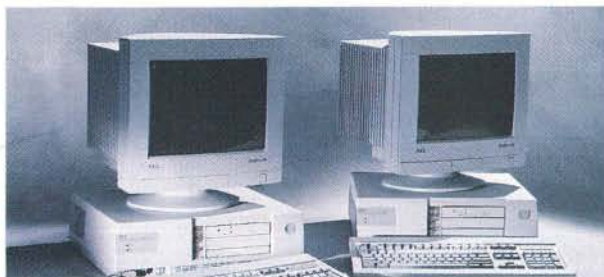

a simple system board exchange you can easily upgrade to the next generation. ■ What's more, our Image Series personal computers are designed so that all

NEC
POWERMATE®
386/33i

NEC
POWERMATE®
SX/20i

COMPAQ®
DESKPRO
486/33

IBM®
PS/2 95
486/25

AST®
BRAVO
486/25

SECONDS

C&C
Computers and Communications

Everyone else has S.

these pieces always work together with peak precision. ■ The PowerMate SX/20i and 386/33i also have 800 x 600 SuperVGA resolution that can expand to 1024 x 768 with 256 colors. Our proprietary

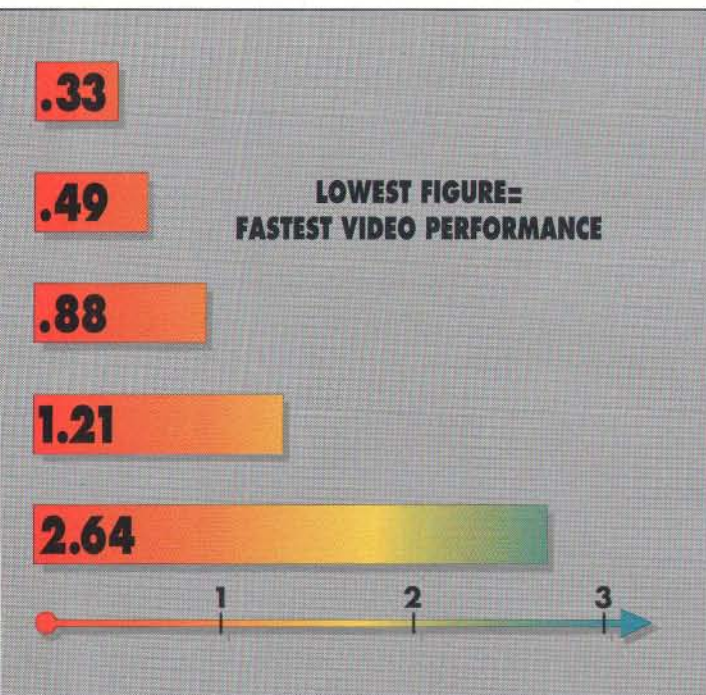

ImageSync™ technology which automatically produces flicker-free graphics when used with NEC's new MultiSync® FG™ series monitors. SIMM sockets for easy and affordable memory upgradability. And FLASH-ROM for simple BIOS maintenance via diskette or network. ■ Even their modular design will impress you. It gives you easy access, so maintenance is effortless. For instance, to open the chassis, just turn the plastic thumb screw and the cover opens up instantly. ■ But what may just be the best part of the Image Series has nothing to do with the comput-

PC Magazine Labs (5.0)

Video Performance Test: Direct Screen Access

ers. And everything to do with the price. ■ Never before has so little gotten you so much. ■ If you'd like more information on our local video bus, or any of the Image Series personal computers (as if there isn't enough information in this ad), call us at 1-800-NEC-INFO or NEC FastFacts, at 1-800-366-0476, # IMAGE (46243). For those of you in Canada, call 1-800-343-4418. ■ Because if you miss our bus, you might not see another for a very long time.

Because  is the way you want to go.

NEC

compile or edit those scripts, and play back a text file you've captured.

"So what?" I thought. I could do most of those things in the DOS version of Procomm Plus with one or two keystrokes. What I'd really like is the ability to adapt the Action Bar for each on-line system I call. Call me picky.

Lo and behold, Procomm Plus for Windows (hereafter, PW) provides a row of *meta-key* buttons at the bottom of the window. You can define up to 40 keys (based on the numerals 0 to 9, Alt, Alt-Shift, Alt-Control, and Alt-Shift-Ctrl). A click on a meta-key button lets you send a text string, run a DOS or Windows program, or execute a script file. You can create a distinct group of meta-keys for each on-line system that you use; the keys appear automatically when you call that system. I'd much rather click on a button than go rummaging through MCI's documentation because I have forgotten the command for editing a half-

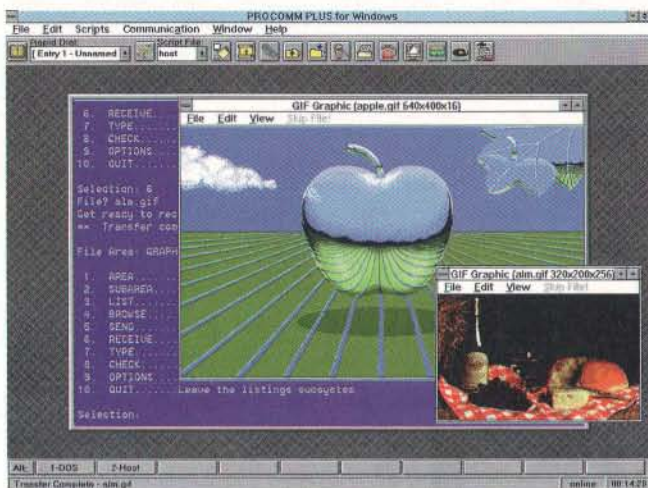

written message.

PW's Action Bar also contains a File Clipboard button that lets you copy filenames from your screen; later, when the host system asks for a filename, you click on the appropriate name and the Clipboard sends it back to the host. The first time I tried that, I thought, "That's silly—even I'm not *that* lazy." But if you're choosing several files from a long list, the Clipboard becomes indispensable.

There's a lot more to PW. It has a script language called Windows Aspect, which lets you create everything from simple

If you have fast workstations and a fast file server, you'll also want a fast network. Even 16 Mbps may be too slow if your applications are data-intensive. I took a look at a set of TCNS network cards from Thomas-Conrad. The version I saw should be available by the time you read this. The network card operates at 100 Mbps and costs only slightly more than token-ring cards. TCNS gives you the advantages of the Fiber Distributed Data Interface without FDDI's high price. I found that NetWare, LAN Manager, PowerLAN, LANtastic, and other ARCnet-compatible network operating systems work well with TCNS. The catch is that you must use fast computers to realize performance gains.

TCNS uses the same shielded twisted-pair (i.e., IBM type 1) or coaxial (i.e., RG62A/U) cabling already in place for token ring or ARCnet. You can also install 62.5-micron fiber-optic cable. Using a

The Fastest LAN Alive

TCNS Smart Hub with different connectors gives you the option of mixing and matching cable types. You wire a TCNS network as a distributed star, just as you would with ARCnet or token ring. TCNS adapters and hubs use ST connectors for fiber-optic cable, BNC connectors for coaxial cable, and DB-9 connectors for shielded twisted-pair cable.

Imagine ARCnet running at 100 Mbps, and you have a good picture of TCNS. A TCNS network adapter is register compatible with an ARCnet adapter, which lets TCNS use industry-standard ARCnet software drivers. Thomas-Conrad also supplies Accelerated Drivers for an even greater performance boost. TCNS workstations use the same reconfiguration process as ARCnet when they enter or leave the network. Over the LAN cable, though, TCNS uses FDDI's 4B/5B encoding scheme to send and receive the ARCnet

THE FACTS

Procomm Plus for Windows
\$149; upgrade for owners of DOS version, \$69

System requirements:
Windows 3.0 or higher, a hard drive with 2 MB of free space, and a modem.

Datastorm Technologies, Inc.
3212 Lemone Blvd.
P.O. Box 1471
Columbia, MD 65205
(314) 443-3282
fax: (314) 875-0595

Circle 1197 on Inquiry Card.

sign-on scripts to complex applications like a fully functional BBS; DDE support; a GIF viewer, which lets you see GIF image files as you're downloading them; a push-button help system (not fully implemented in the beta version I used); and more.

Now that I'm used to PW's graphics niceties, it's hard to imagine doing without them. Call me a believer. Or call me on BIX; I've got some neat buttons to try out.

—Kenneth M. Sheldon

packets. It's the best of both worlds.

TCNS consists of network adapters with shielded twisted-pair, coaxial, or fiber-optic connectors; one or more Smart Hubs; and software drivers. The adapters come in 16- and 32-bit and ISA- and EISA-bus varieties. You can put up to 255 TCNS workstations on a single LAN segment, and you can span large distances: 2950 feet (hub to workstation) with fiber-optic cable, 492 feet with shielded twisted-pair cable, and 338 feet with RG62A/U coaxial cable.

A TCNS adapter contains an AMD TAXI chip set. Thomas-Conrad developed the firmware and microcode for TCNS by layering its own chip designs on top of TAXI. The 4B/5B encoding scheme lets TCNS transmit 4 data bits as 5 signal bits, making it 80 percent efficient.

TCNS cards, like most token-ring cards, use 16 KB of upper memory. I was easily able to configure 386Max to load DOS

BEFORE PROTECTING YOUR SOFTWARE...

...against piracy and unauthorized use, make sure that your protection system has all the following qualities:

A GOOD HARDWARE KEY

Hardware-based software protection systems are now the standard worldwide. However, not all keys are the same. A good key should have all the following features:

✓ Compatibility and transparency. The key should work without any problem on your customers' computers. The user should be able to forget the key after connecting it.



✓ Unbreakable electronics. A customized ASIC (Application Specific Integrated Circuit) component should be integrated in the key. This prevents reverse engineering and makes cracking virtually impossible.

✓ A unique and inaccessible software developer's code burnt into the ASIC. (This code should not be held in the key's memory, where it can be read and altered.)

✓ A Read/Write Memory inside the key should be available on demand. The memory should be writable in the field, on any PC, without any special programming equipment.

✓ Very low power consumption, enabling the key to work even under the worst power conditions, on PCs and laptops, with or without a printer.

POWERFUL SOFTWARE

Since it's practically impossible to crack or duplicate a key having all the features

mentioned above, a pirate will usually go for the software linking the protected program to the key. Therefore, check that your protection software has all of the following:

✓ A Linkable Protection Module with which calls can be made to the key from any point in the protected program.



✓ An "Envelope" installation program. Such programs enhance security while making it possible to protect a software even without its source code.

✓ Sophisticated antidebugging and encryption mechanisms.

HASP®, THE PROFESSIONAL SOFTWARE PROTECTION SYSTEM, OFFERS YOU ALL THESE FEATURES AND MORE:

HASP was designed by a team of computer experts, professional cryptologists, and electrical engineers. As a result, HASP keys are supported by what is probably the best software in the market, and the HASP system has worked on every computer it has been tried on. In addition to all the features mentioned above, HASP provides:

✓ A Full Authorization System for protecting dozens of programs using only one key.

✓ A Pattern Code Security System (PCS) enabling parallel processing of multiple calls by the Linkable Protection Module.

✓ A Virus Detection option that can be incorporated in the protected program to check whether it has been infected by a virus or tampered with in any way.

✓ Several HASPs can be connected one behind the other.

✓ Operating systems supported: DOS, SCO Xenix & Unix-386, OS/2, WINDOWS, AIX, AUTOCAD, PHAR-LAP, ERGO and RATIONAL DOS Extenders.

✓ NetHASP provides full support for protecting DOS and WINDOWS software under network environments, including Novell dedicated & non-dedicated servers, Lan Manager, Lantastic, Banyan, DLink, and all NET-BIOS based LANs.



IN A TEST CARRIED OUT BY AN INDEPENDENT LAB, HASP WAS THE ONLY KEY WHICH WAS NOT BROKEN*.

AND THE BOTTOM LINE:

we offer some of the most competitive prices in the market.

Since 1984, HASP has enabled thousands of software producers in more than 40 countries, including several Fortune 500 companies, to protect their software.

To learn more about why so many professionals have chosen HASP, please contact:



15 Beit Oved St., Tel-Aviv, Israel
P.O.Box:11141 Tel-Aviv 61110
Tel: 972-3-5375795
Fax: 972-3-5375796

In North America:

ALADDIN SOFTWARE SECURITY

306 Weymouth St.,
Dix Hills, NY 11746, USA
☎ 800-223 4277
516-586 2845
Fax: 516-586 1602

- ✓ Australia Conlab Pty. Ltd., Tel: 3 8985685, Fax: 3 8995759
- ✓ Belgium Akkermans bvba, Tel: 3 2338826, Fax: 3 2315438
- ✓ Czechoslovakia ATLAS Ltd., Tel+Fax: 2 766085
- ✓ Denmark SC Metric a/s, Tel: 42 804200, Fax: 42 804131
- ✓ France Logidata Intl., Tel: 50707375, Fax: 50753144
- ✓ Germany CSS GmbH, Tel: 201 749860, Fax: 201 748644
- ✓ Greece Unibrain SA, Tel: 1 6856320, Fax: 1 6474943
- ✓ Holland Akkermans BV, Tel: 45 241444, Fax: 45 245515
- ✓ Italy Partner Data S.r.l., Tel: 2 33101709, Fax: 2 347564
- ✓ Korea Hanil System Inc., Tel: 2 5639161, Fax: 2 5538079
- ✓ New Zealand Training Solutions, Tel: 4 5666014, Fax: 4 5697190
- ✓ Poland Systherm Tel: 061 45065, Fax: 061 324134
- ✓ Portugal Futurmatia Lda., Tel: 1 4116269, Fax: 1 4116277
- ✓ Spain PC Hardware, Tel: 3 449 3193, Fax: 3 3337497
- ✓ Switzerland Opag AG, Tel: 61 7112245, Fax: 61 7115355
- ✓ Taiwan Teco Ltd., Tel: 2-5219676, Fax: 2-5425939
- ✓ Turkey Mikrobeta Ltd., Tel: 4-4677504, Fax: 4-4670274

* CT Magazine, May 1990.

© Aladdin Knowledge Systems Ltd. 1985-1992

Circle 75 on Inquiry Card.

NATURAL

For Results that

Monument Valley, Arizona



Fans, Enclosures and Components



Books



Integrated Circuits and RAM Modules



Jameco Tool Kits



Graphics Cards



Floppy Disk Drives



Please refer to Mail Key 1 when ordering



Terms: Prices are subject to change without notice. Items subject to availability and prior sale. Complete list of terms/warranties is available upon request

RESOURCE

are Monumental



**Announcing
Jameco
ServiceLine™
Computer Repair
and Support
1-800-831-8020**

**Get Your Free
Jameco Catalog Today.
Call Our 24-Hour Hotline
1-800-637-8471**



COMPUTER UPGRADES

Perfect Resource to Saving Money!

Boost your computer power with Jameco high performance components. Plug in a new motherboard, more memory, or a co-processor. Add a high-capacity hard disk drive, high-resolution monitor, video card, and more. Our technical support phone team helps you make perfect upgrade selections for your system. Install all items yourself or we can do it for you. Ask for details. Either way, our team backs your every step. Power-up and Save!

Buy exactly what you want, when you want it, at competitive prices – with complete confidence in performance. Monumental results are yours with one phone call to Jameco, your natural electronic and computer product resource for over 18 years.

A wide product selection, expert technical phone support and information exchange assure that you find exactly what you want. Our 24-hour toll-free direct or fax ordering team stands ready. Most items are in stock. Same-day shipping is standard and one-day delivery always an option. Our large inventory and efficient operation mean consistently competitive prices. And our quality-tested products are warranted and backed by a 30-day full refund guarantee.

Shop on your schedule: from your office, lab or home. Just open our catalog, it's your resource for products and services whether your setting is in the home, at school or in business. Call our toll-free number to obtain your free catalog.

Discover our commitment to your convenience and satisfaction. Make your next electronic and computer product purchase directly from Jameco. See why so many people, year after year, continue to naturally choose Jameco electronics.



Motherboards, Computer Cases,
Keyboards, Power Supplies and Monitors

JAMECO®
ELECTRONIC COMPONENTS
COMPUTER PRODUCTS

1355 Shoreway Road, Belmont, CA 94002

Sales: 1-800-831-4242

Outside US: 415-592-8097

FAX: 1-800-237-6948

ServiceLine™: 1-800-831-8020

Technical Support: 1-800-831-0084

and my TSR programs in upper memory around the TCNS card. The on-board RAM is zero-wait-state memory.

How fast is TCNS? I tested a set of TCNS cards on my LAN. With a 33-MHz 486 EISA-bus file server running NetWare 3.11, and with a set of workstations that includes 33-MHz 386 computers as well as an old IBM PC, I found that the workstations could read and write files to and from the server about as fast as they could read and write files to a workstation RAM disk. The BYTE LAN benchmarks measured TCNS's message-passing speed at 700 KBps. That's quick. TCNS definitely eliminates the network cables and network adapters as a bottleneck.

If you use an old, slow IBM XT on a LAN, you don't need TCNS. I noticed that

TCNS didn't help my original-issue, five-slot IBM PC perform any better than Ethernet, token ring, or ARCnet. But fast workstations are different. A 386 workstation will operate faster than some networks can deliver the data. TCNS eliminates the network bottleneck for such workstations.

Datapoint announced a 20-Mbps ARCnet-Plus product almost two years ago, but it has yet to ship it. The fiber-optic version of TCNS has been available for about a year, but the shielded twisted-pair and coaxial TCNS cards and hubs are new. A cost of \$745 for a 100-Mbps, 16-bit copper-based network adapter—in a fast workstation or server, of course—is a reasonable price to pay for performance.

—Barry Nance

THE FACTS

TCNS

TCNS network adapters, \$745 to \$1595; Smart Hubs, \$1995 to \$2495

System requirements:

NetWare, LAN Manager, LANtastic, or any ARCnet-compatible network operating system.

Thomas-Conrad Corp.

1908-R Kramer Lane

Austin, TX 78758

(800) 332-8683

fax: (512) 836-2840

Circle 1198 on Inquiry Card.

The Many Masks of Picture Publisher 3.0

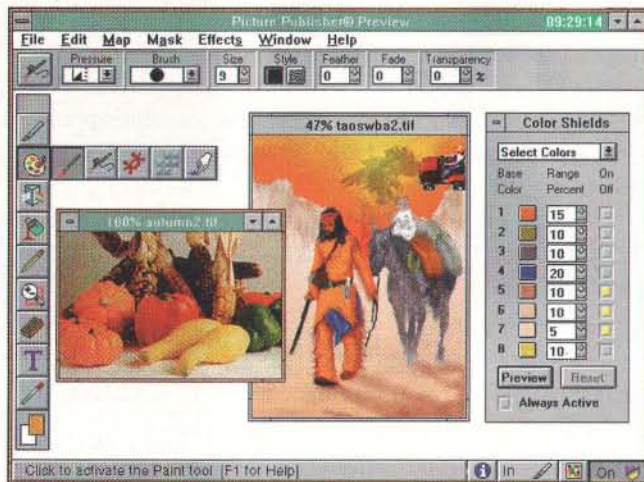

Not long ago, you needed a Mac to perform editing wizardry on your color bit maps and scanned images. But some new Windows 3.0 image editors have changed that—take a look at **Picture Publisher 3.0** from Micrografx.

For starters, the prerelease version of Picture Publisher that I looked at featured a decidedly tidier interface. Just below the standard menu bar, a ribbon area displays the available options for the active tool. The tools are stored in a movable toolbox, which is neatly organized into broad categories. Subcategories expand when the general tool is selected.

Picture Publisher's most impressive feature stems from its masking capabilities.

point, and an auto-masking tool traces along a line between each click. This gives you more control while still freeing you from the harrowing task of tracing along an irregular edge.

Once you've created the mask, you can save it or copy the enclosed image to a named clipboard, a texture, or even a custom brush. You can limit most operations to the area within a mask or apply them to everything outside the mask.

Another spiffy feature, color shields, lets you select or protect up to eight colors at once. You can easily change all the greens in an image to a deeper shade or transform a blue sky into a red one without obscuring a bank of white clouds.

You can create an unlimited number of masks using standard shapes, a freehand tool, or a magic wand that automatically traces around a selected edge. The magic wand is a handy tool offered by many packages, but it doesn't always follow the pattern you have in mind. Picture Publisher's goes a step further. You can click from point to

The tricky task of integrating a pasted object into an existing image has never been easier. Using color shields, you can selectively remove the unwanted color surrounding a pasted object.

Picture Publisher 3.0 supports many file formats and color models. Print options enable automatic color separations and color adjustments for specific output devices. With the text tool, you can do some fun things with text.

You'll be hard-pressed to find anything that Picture Publisher can't do. Image editing on the PC has definitely arrived. ■

—Stanford Diehl

THE FACTS

Picture Publisher 3.0

\$795

System requirements:

A 386 PC with 4 MB of RAM, a 40-MB hard drive, Windows 3.0, a mouse, and a VGA display (Super VGA is recommended).

Micrografx, Inc.

1303 Arapaho

Richardson, TX 75081

(800) 733-3729

(214) 234-1769

fax: (214) 234-2410

Circle 1199 on Inquiry Card.

OUR COMPACT NOTEBOOK JUST GOT 30% BIGGER

CompuAdd
Express

325 *NXL*

**NOW
80MB!**



...AND PACKING FOR TRIPS JUST GOT

Now there's less to worry about when you're packing for a business trip. Got your airline ticket? The right clothes? Your presentation materials? You'd better check. But when it comes to your notebook computer, you won't have to



worry when you carry an Express 325NXL. Because the 325NXL now packs an 80MB hard drive! That's a 30% increase over our old 60MB. So you can fill it with applications and data — and always have them handy. There's plenty of room! With its built-in trackball and fax/modem, 4MB of RAM, 25MHz of 386SX speed and the amazing, utility-filled DR DOS 6.0, you won't be leaving features at home for portability's sake, either. And you'll have cash left for traveling. Because the 325NXL is **ONLY \$2,095**

Even with all these features, the 325NXL weighs less than 6 pounds — including battery — and measures only 8.5" x 11". It fits comfortably into your briefcase. But just in case you want to pack it separately, we give you a free carrying case.

Look at our video display. It's sharper than other notebooks'.

✓ A big 9.4" screen, measured diagonally ✓ With 64 levels of grayscale for a bigger, clearer image than notebooks with only 16 or 32 levels. ✓ .30mm dot pitch ✓ A super-twist backlit liquid crystal display. ✓ Or hook up to a VGA monitor using the 325NXL's external VGA video connector.

When you run Windows on the road, this is the notebook to use. ✓ Our 80MB hard drive and 4MB of RAM mean big Windows programs run just fine. ✓ Use DR DOS 6.0 data compression and your drive can hold up to 160MB! ✓ Transfer data easily with a 1.44 MB 3.5" internal floppy drive.



3.5" internal floppy

Why carry a clip-on trackball? The 325NXL has one built-in so you'll always have a trackball for Windows applications. ✓ 200dpi for accurate pointing. ✓ Two click buttons select icons and commands. ✓ In the office, connect a mouse using the 325NXL's external PS/2 mouse connector.



Add a coprocessor

You won't have to wait until you're in your office to get to work. And you won't have to wait for your data while you're using your 325NXL. ✓ Our 25MHz 386SX microprocessor is faster than most other notebooks', which typically run at only 16MHz or 20MHz. ✓ Add a math coprocessor, and applications that use floating point instructions will run even faster. ✓ Order a coprocessor with your notebook and we'll install it for you.

Communication is so important on the road, you shouldn't have to pay extra to add it. ✓ So the 325NXL has a built-in 9600 baud fax / 2400 baud modem. ✓ And **FREE** Quick Link II fax/modem software. ✓ The 325NXL has one RS-232 serial port and one parallel printer port so you can connect to printers and other peripherals, too.

You'll feel right at home on our keyboard. ✓ It has the familiar IBM feel because it's made by the same manufacturer. ✓ The standard 101-key function keyboard is implemented with 84-key layout. ✓ And the inverted "T" arrow keys are just like your standard keyboard's — in the lower right hand corner and easy to find. ✓ Connect to a standard PS/2 keyboard with our external keyboard connector.



Inverted "T" arrow keys

You won't be stranded without power. ✓ Because the 325NXL's built-in power management logic gives you 3 to 4 hours of battery life. ✓ Close the lid, and a sleep button shuts down the display and drives but preserves your data. ✓ Our AC adapter is compact and easy to take with you.

Ordering's a breeze, too. Just call us toll free at:

800-925-3525

EASIER



Free carrying case



Built-in trackball



1 serial, 1 parallel port; fax/modem; keyboard; mouse; VGA monitor connections.



Power, display control, sleep buttons on keyboard

We accept MasterCard, VISA, money orders, certified checks (please allow ten days for processing), CODs (\$50 deposit required), company and institutional purchase orders (minimum initial purchase \$250, thereafter \$50 with approved credit) and wire transfers. Shipping charges are calculated according to weight and distance. Texas residents, please add appropriate local sales tax. CompuAdd Express will replace or repair defective hardware, software and consumable items. A 15 percent restocking fee may be charged. All return items must be accompanied by a return merchandise authorization (RMA) number. Prices and product descriptions are subject to change without notice. CompuAdd Express is not liable for damage due to omissions or typographical errors.

Circle 89 on Inquiry Card.



Express 450DX2 \$2,395

120MB AND NI-HRVGA

When you want to travel fast, get on board the Express 450DX2.

Announcing: Our fast 450DX2 with clock doubling technology. Get all the power and features of a 486DX. But get them with 70 percent more speed! And with Express economy! You save money

because we build our 450DX2 around the clock doubling DX2 chip — leaving out the unnecessary DX chip that many manufacturers include. We save you technical worries, since our one chip runs cooler than the other guys' two. But we give you full 486DX power, including built-in coprocessor and on-chip cache. Plus enhancements like 64KB RAM cache on the motherboard and a non-interlaced monitor.

You'll also have Express controllability. Because the 450DX2 comes preloaded with DR DOS 6.0, the operating system that includes a data compression feature that can give you up to double the normal space on your hard drive. And Express expandability. Because you get our standard dual floppy drive that frees two bays for extra hard drives, a tape backup or CD ROM.

Systems for Every Need

The 450DX2 is our most powerful system. But for computer users with less demanding needs, we offer a full line of 486DX, 486SX, 386DX and 386SX systems. All with Express enhancements like our dual floppy drive and DR DOS 6.0. And all with amazingly low prices!

433 - \$2,195

486DX/33MHz; 120MB HD; NI-HRVGA

420s - \$1,895

486SX/20MHz; 80MB HD; NI-HRVGA

333 - \$1,695

386DX/33MHz; 80MB HD; NI-HRVGA

325s - \$1,395

386SX/25MHz; 40MB HD; NI-HRVGA

CompuAdd

Express

Call to order, for other system configurations or for a free catalog:

8 0 0 - 9 2 5 - 3 5 2 5

512-219-1800 Fax 512-219-2890

Hours: 8AM-6PM Mon-Fri CST 12306 Technology Boulevard, Austin, Texas 78727

Crisp Color Goes Portable

The UltraLite SL/25C notebook computer supports multiple resolutions on its TFT (thin-film-transistor) active-matrix color LCD. Resolutions of 640 by 480 pixels with 16 colors and 320 by 200 pixels with 256 colors are coupled with a 60-Hz refresh rate, a dot pitch of 0.3 mm, and 256 KB of video RAM for crisp images. The machine supports simultaneous displays on its 9½-inch screen and on an external CRT display.

With a 25-MHz 386SL processor and an 80-MB hard drive, the SL/25C includes 2 MB of RAM (expandable to 10 MB), 64 KB of cache memory, a 3½-inch floppy drive, and four automatic power-saving modes. DOS 5.0 and Windows 3.0 are preinstalled.

Standard interfaces include serial, enhanced parallel, keyboard, keypad, PS/2 mouse, Super VGA, and external floppy drive ports. The unit has an internal modem slot and an optional docking station, which is easily transportable.

Price: \$5999.

Contact: NEC Technologies, Inc., 1414 Massachusetts Ave., Boxborough, MA 01719, (800) 632-4636 or (508) 264-8000.

Circle 1271 on Inquiry Card.



The NEC UltraLite SL/25C has active-matrix color.

Alphanumeric in Windows

Based on the Display Industry Association's Alpha Window standard, the AlphaWindow Terminal from Cumulus combines the simplicity, reliability, and lower cost of standard Unix terminals with the advantages of a windowing environment. Working in Unix on the AlphaWindow Terminal, you have mouse capabilities and can move data between applications

and close and open windows. The terminal supports up to 16 sessions and 22 windows, each running different applications.

The AlphaWindow Terminal has a 15-inch, nonglare, monochrome flat

AlphaWindow Terminal

screen with more than 90 square inches of active display surface and a refresh rate of 75 MHz. Displays are in 80- and 132-column modes, and you can run any text-mode Unix applications within multisession windows without modification. **Price:** \$759; limited license software, \$459.

Contact: Cumulus Technology Corp., 1007 Elwell Court, Palo Alto, CA 94303, (415) 960-1200; fax (415) 960-3522.

Circle 1272 on Inquiry Card.

Keeping in Step

Expandable and fast, the 50-MHz Step 486/50e Megacube has 12 expansion slots (10 EISA, one 8-bit, and one 64-bit proprietary memory) and supports a 33-Mbps burst throughput rate. The proprietary Advanced Memory Management Architecture write-back

cache is scalable from 128 to 256 KB. Standard RAM is 8 MB.

The modular unit includes the Everex Thermal Management System to lower system temperature and two variable-speed SmartFans to reduce thermal stress. Security features include system locks, a protected system power switch, and software password protection.

Price: Starts at \$7899.

Contact: Everex Systems, Inc., 48431 Millmont Dr., Fremont, CA 94538, (800) 992-3839.

Circle 1273 on Inquiry Card.

Midrange Decision Making

Based on AMD's 386DXL microprocessor, the Decision 386/40 is geared toward desktop publishing, scientific analysis, and CAE. A multispeed ISA expansion bus offers turbocharged speeds of 10 and 13.33 MHz, with a default speed of 8 MHz.

Configured with 4 MB of RAM (expandable to 64 MB via 36-bit SIMMs), a 128-KB cache (upgradable to 256 KB), two serial ports, a parallel port, and DOS 5.0, the unit includes a socket for a 40-MHz 387-compatible math coprocessor. A 1.2-MB floppy drive is standard; optional 120-MB and 200-MB hard drives are available, as is a 1.44-MB floppy drive. Six expansion slots accept 8-bit and 16-bit ISA cards.

Price: Starts at \$1999.

Contact: Wyse Technology, Inc., 3471 North First St., San Jose, CA 95134, (800) 438-9973 or (408) 473-1200; fax (408) 473-2080.

Circle 1274 on Inquiry Card.



Become Master of Your Equipment

Gain intelligence over your infrared equipment and control it all with a single IR command. Connected to the serial port of your Mac or PC, the IR Jukebox recognizes, transmits, and receives infrared commands to a distance of 30 feet.

The IR Jukebox has five software-selectable output channels. The single internal channel provides a 120-degree spread of IR in a room, while the four external channels let you address individual IR components. Firmware modules are built in, and you can add custom modules. When you start the software, you gain access to Channels and Jukebox modules, in which you can run IR screens by time and event and create and sort sets of CDs or record albums. **Price:** \$479; Developer Kit, \$379.

Contact: DanCraft Enterprises, 5520 West 118th Place, Inglewood, CA 90304, (310) 643-8782. **Circle 1275 on Inquiry Card.**

Have Memory, Will Travel

A palm-size removable hard drive with 120 MB of storage, the Disctec RHD 120 has an average seek time of 15 ms and a data transfer rate of 10 Mbbs. Based on the IDE interface, the 7-ounce drive is compatible with portable and desktop computers with a Disctec Docking Bracket

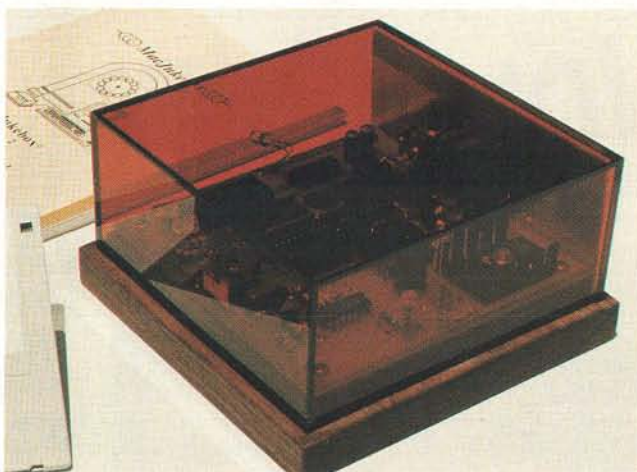

The IR Jukebox lets you control your infrared equipment.

installed. If no files are open, you can change the drive while the computer is running.

Price: \$1295; docking bracket, \$65 to \$100. **Contact:** Disk Technologies Corp., 925 South Semoran Blvd., Suite 114, Winter Park, FL 32792, (800) 553-0337 or (407) 671-5500; fax (407) 671-6606.

Circle 1276 on Inquiry Card.

3-D Mouse Has Its Feet on the Ground

Mouse Systems' 3-D mouse lets you work in CAD and do computer modeling without lifting your mouse off the desk. Incorporating the company's M5 optical technology, the 3-D mouse provides 6 degrees of freedom—x, y, z, pitch, yaw, and roll—and works as a 600-cpi-resolution mouse, allowing hand and arm motion associated with standard mouse use.

Price: \$299. **Contact:** Mouse Systems Corp., 47505 Seabridge Dr., Fremont, CA 94538, (510) 656-1117; fax (510) 770-1924.

Circle 1277 on Inquiry Card.

SCSI-2 Drive Darts Through Its Work

With no moving parts to slow it down, the SCSI II Dart drive achieves a sustained 12.16-Mbps data transfer rate on a computer running DOS and an 11.9-Mbps rate on Macs. The drive has a seek time as low as 0.1 ms on DOS PCs and less than 0.01 ms on Macs, and access times as low as 0.5 ms on both machines. When working with animation, the drive can deliver about 40 8-bit frames per second. The drive has 32 SIMM sockets that hold standard 1-, 4-, and 16-MB SIMMs to a maximum of 512 MB of RAM.

Price: With four 1-MB SIMMs, \$4700. **Contact:** Newer Technology, 7803 East Osie St., Suite 105, Wichita, KS 67207, (800) 678-3726 or (316) 685-4904; fax (316) 685-9368. **Circle 1278 on Inquiry Card.**

New Shape for TrackMan

The second generation of the TrackMan stationary desktop mouse lives in a case that closely conforms to the natural shape of the human hand, putting the ball directly under your thumb when you're using the device. Thus, TrackMan operates in the same minimal space as its dimensions. The unit also features three buttons for versatility in programming in DOS and Windows. You can assign hot keys to one or two of the buttons.

Price: \$139.

Contact: Logitech, Inc., 6505 Kaiser Dr., Fremont, CA 94555, (510) 795-8500; fax (510) 792-8901.

Circle 1279 on Inquiry Card.

Lightweight Portable Power

Portable IDE hard drives that plug into your laptop, notebook, or pen-based computer's parallel port range in capacity from 40 to 360 MB and are compatible with Windows 3.0 and higher. The 2½-pound drives' on-the-fly data compression uses proprietary disk controller software that takes up 15 KB of system RAM.

Price: \$499 to \$1999.

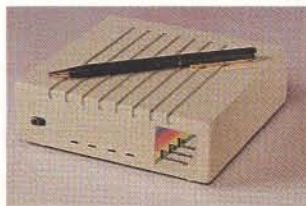

Contact: Parallel Peripherals Technology, Inc., 260 West Arrow Hwy., San Dimas, CA 91773, (800) 222-7240 or (714) 394-7244; fax (714) 394-7242.

Circle 1280 on Inquiry Card.

WILL YOU REMEMBER EATS YOUR MEMORY?



Just remember NOVI™ needs no updates. NOVI prevents or detects and perfectly repairs both known and unknown computer viruses from the moment you install it. NOVI works equally well on single PCs or LANs and is fully Windows™ compatible. Although NOVI can scan for viruses faster than anything else, virus scanning is one thing you can forget about forever. Just let NOVI's patent-pending "Integrity Management" take care of your PCs. There will be no hassles, no maintenance and no user intervention. You can forget about costly and time-consuming updates also, because you won't need them.

Viruses are creative little monsters that can eat up your profits.

Viruses spread very innocently from normal computer usage. Bulletin boards, hackers and malicious employees are not the problem. Almost 90% of infections come from diskettes, half from data-only diskettes and 3% from shrink-wrapped software. No one is immune. There were nearly 1,000 known viruses in 1991. Between three and five new viruses are created each day. Here are just three examples:



CASCADE VIRUS. By the time anyone sees the falling letters, your entire site is likely to be infected.

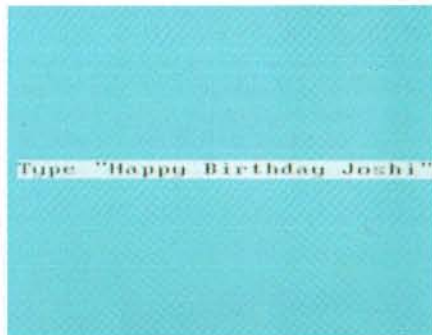

JOSHI VIRUS. This extremely common stealth virus damages hard drives and about half the floppies it travels on.

THIS AD AFTER A VIRUS

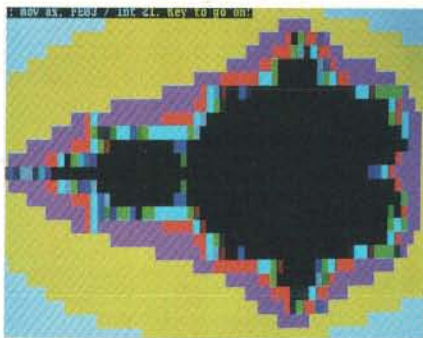

TEQUILA VIRUS. Using advanced anti-scanner and stealth techniques, the virus infects LANs and corrupts hard drives.

Do you think a virus could never happen to you?

Over 60% of American companies and governmental agencies are hit by viruses each quarter. The likelihood of a major virus disaster is doubling every four months.*

*All data from Dataquest/National Computer Security Association virus study (11/91).

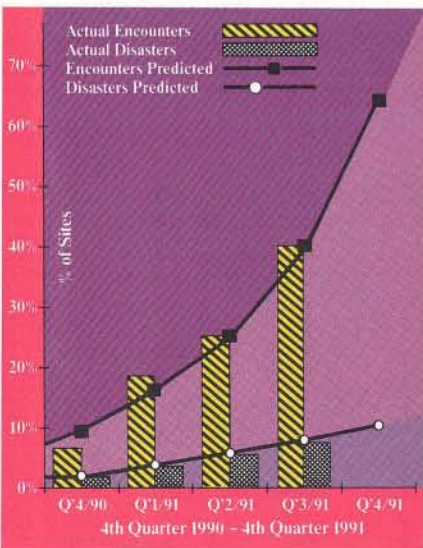

Actual and projected percent of organizations experiencing virus disasters each quarter in North America (Dataquest).

How much are your data and downtime worth?

Viruses are no longer someone else's problem, as many businesses have discovered. When a virus hits, it can not only destroy your data and programs, it can also knock out your entire network. A virus puts you offline until the problem is solved, while it ties up your best people for hours or days. With NOVI, you're always protected and productive.

Designed to work in corporate computing environments.

NOVI has no database to maintain, no approval lists, no user updates or maintenance. It produces virtually no false alarms, even when its known-virus features are turned off. NOVI prevents file and system areas from getting infected in the first place. But if an infection occurs, NOVI perfectly repairs it, and returns you to normal operations. NOVI can do all of this automatically and invisibly, without showing a single user message. Or it can be set up to show up to a dozen customizable messages for you and your PC security personnel.

NOVI is the first Object Oriented anti-virus system. You can choose objects and tailor their behavior exactly to the needs of your environment. It occupies from 60 to 600 KB of disk space (with two on-line manuals and a comprehensive virus information base) and as little as 1.6 KB of RAM.

Easy to install, easy to use.

Installing NOVI can be as easy as booting from a NOVI "Clone" diskette or logging onto the LAN - no questions asked. A comprehensive LAN installation can be done under a minute. Logs of virus encounters can be stored locally or sent as a message to a LAN administrator.

Circle 192 on Inquiry Card (RESELLERS: 193).



Pac pricing protects organizations at less cost.

Multiple installation users get significant savings per unit with our unique 10, 25, 50, 100, or 500 pac licenses. This eliminates hundreds of boxes and manuals and provides you with enough licensed software to handle your entire organization or LAN.

Software Digest



Ranked by SOFTWARE DIGEST as the #1 anti-virus program. (Vol. 8.11-1991) "NOVI completely out-classes the other programs with pure speed."

NOVI comes from Certus International, with a five year history of specializing in anti-virus, integrity management and systems management software.

Call 1-800-SAY-NOVI.



certus

Certus International Corporation

6896 West Snowville Road
Brecksville, Ohio 44141 • 216-546-1500

©SOFTWARE DIGEST is a registered trademark of National Software Testing Laboratories, Inc., a Datapro co.

Monitor Power on the Bus

The PC-Bus Power Monitor Card detects power disturbances and spots bad power supplies from its location in an expansion slot of your PC. The monitor checks to see that the supplies are within specification, detects the presence of glitches or dropouts, and displays the information on an LED array. The basic card provides a real-time indication of power quality and remembers momentary out-of-tolerance operation. The enhanced version has an audible alarm and separate monitoring circuits for the system clock and DRAM refresh signal.

Price: Starts at \$195.
Contact: Wintek Corp., 1801 South St., Lafayette, IN 47904, (800) 742-6809; fax (317) 448-4823.
Circle 1281 on Inquiry Card.

Three Routes to Video

The Artist WinSprint 200 graphics board for Windows includes a panoramic view, for instant access to a 2048- by 1024-pixel-resolution virtual window in 16 colors on your 640- by 480-pixel-resolution VGA monitor. Within an application, Panorama lets you pan across twice the normal amount of data. When using dual applications, you can view two large windows, cutting and pasting between them. You can switch back and forth among as many as five open full-size windows. The WinSprint 200 displays 16 and 256 simultaneous colors at 1024- by 768-pixel resolution. The board has 1 MB of video RAM and supports VGA pass-through.

Price: \$995.

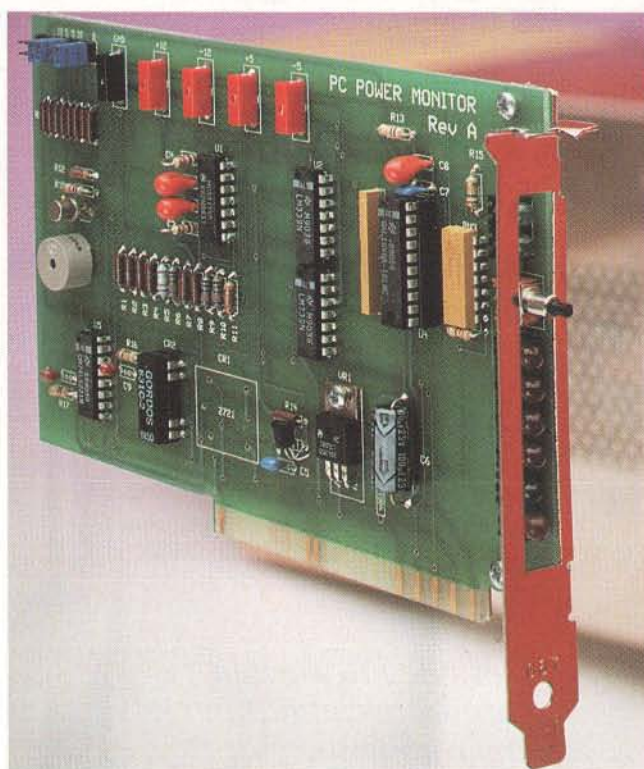

Keep the bus running with the PC-Bus Power Monitor Card.

Contact: Artist Graphics, 2675 Patton Rd., St. Paul, MN 55113, (800) 627-8478 or (612) 631-7800; fax (612) 631-7802.

Circle 1282 on Inquiry Card.

The Volante AT2000 displays 24-bit true color in resolutions of up to 1024 by 768 pixels. A resolution of 1280 by 1024 pixels, noninterlaced, with 16 or 256 colors, is available.

The field-upgradable AT2000 supports up to 4 MB of video RAM and 8 MB of DRAM. Mach-speed Windows and AutoCAD drivers triple the speed provided by older drivers. NDI-developed application-specific ICs are included.

Price: \$1495 to \$1995.
Contact: National Design, Inc., Houston Building, Suite 230, 9171 Capital of Texas Hwy., Austin, TX 78759,

(512) 343-5055; fax (512) 343-5053.

Circle 1283 on Inquiry Card.

The Xceed MacroColor 30, a 24-bit video card for the Mac SE/30 and IIsi, displays true-color images on most external 13- and 14-inch monitors and supports the 12-inch Mac RGB monitor. Resolution in true color is 640 by 480 pixels (512 by 384 pixels on the RGB monitor).

The card includes a gamma color correction utility and the MacroPaint 8-/24-bit color paint program. Virtual Video utility software provides access to a larger display area than the monitor can physically provide.

Price: \$599.
Contact: Micron Technology, Inc., 2805 East Columbia Rd., Boise, ID 83706, (208) 368-2100; fax (208) 368-4558.

Circle 1284 on Inquiry Card.

Oscilloscope Card for the PC

The CompuScope 250 supports 8-bit 100-MHz digitizing in your PC. The single-slot XT-bus oscilloscope card features 100-megasample-per-second digitization on one channel and 50-megasample-per-second simultaneous digitization on two channels. The card has 16 KB of memory depth per channel, external trigger capability, and software drivers.

Price: \$3500.

Contact: Gage Applied Sciences, Inc., 5465 Vanden Abele, Montreal, Quebec, Canada H4S 1S1, (514) 337-6893; fax (514) 337-8411.

Circle 1285 on Inquiry Card.

Put IDE Drives in Your PS/2

The AC-1075 IDE/Micro Channel Hard Drive Adapter upgrades your PS/2 Model 50 and Model 50 Z computers to support two IDE hard drives with up to 1 GB of RAM each. The internal adapter provides 5 and 12 V DC directly from the Micro Channel so that you can install the drives internally. Automatic drive recognition detects the drive type and sets the drive parameters.

The adapter's proprietary on-board BIOS is fully supported by DOS, OS/2, Interactive Unix, and Windows 3.0 without external software. Adapter software lets you interface with NetWare and NetWare Lite.

Price: \$195.
Contact: Arco Electronics, Inc., 5830 Sheridan St., Hollywood, FL 33021, (305) 961-1666; fax (305) 964-1984.

Circle 1286 on Inquiry Card.



Test your apps. Not your patience.

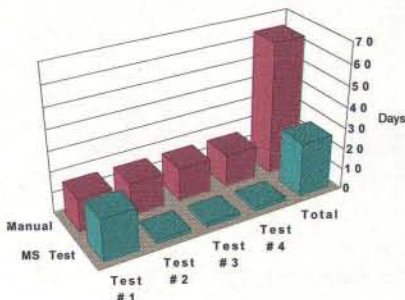

After programming your initial test, Microsoft Test can save you hours, even days, with each subsequent test.



Use a recorder to quickly create test scripts that simulate keystrokes and mouse movements in your application.

Testing your Windows™-based applications can be painfully slow. Then again, not testing them can be disastrous.

But finally you can do it fast and do it right. With Microsoft Test for Windows Software Testing Automation Tool.

Once you've prepared your test scripts, Microsoft Test runs automatically. Without goofing up.

It simulates keystrokes and mouse movements, 24 hours a day. And it constantly evaluates your application, while recording what went wrong and what went right, and why.

What's more, it can finish a test in days, instead of weeks. Plus, it repeats each test exactly, for greater accuracy.

The final result: you can run higher quality tests. You can produce higher quality applications. And you can save literally hundreds of hours in the process.

So call us at (800) 541-1261, Department A02.

We'll show you how to put your Windows-based applications through their paces. At a much faster pace.

© 1992 Microsoft Corporation. All rights reserved. Printed in the USA. For more information inside the 50 United States, call (800) 541-1261, Dept. A02; outside the U.S. and Canada, call (206) 936-8661. Customers in Canada, call (800) 563-9048. Microsoft is a registered trademark and Windows and Visual Basic are trademarks of Microsoft Corporation.

Key Features

- TestDriver, the environment for developing and running test scripts, includes an enhanced version of the Basic language, TestBasic, for efficient script creation.
- Functions which simulate keystrokes and mouse movements reduce testing time.
- Trap command, to trap unexpected events, such as UAEs, allows test script to stay in control.
- Recorder for keystrokes and mouse movements creates editable TestBasic test scripts easily.
- High-level English-like functions help users create test scripts quickly.
- Fast, exact comparisons between actual and expected results verify application quality.
- Screen capture and compare functions provide additional test results to verify application functionality.
- No hooks or debugging code needed, so Microsoft Test can be used with the final version of almost any application for Windows, no matter what development tool was used to create the application.

PROGRAMMER'S TIP

As an alternative to using Basic script language, call the Microsoft Test API with your favorite language, such as Microsoft Visual Basic™ or Microsoft C. Included in the product are .H and .LIB files for linking the TestCtrl, TestDlgs, TestScrn and TestEvt functions into your C program.

Microsoft
Making it easier

Northgate® ZXP™... Unlimited i486™

You want flexible, easy upgrades, quality, reliability and top caliber service and support at reasonable prices? Northgate delivers with Elegance ZXP systems! This spectacular new range of systems was engineered to give you the power you need today PLUS unlimited 486 upgradability for tomorrow.

Northgate is the leader in upgradable 486 technology. Factor in a choice of: Three cabinet styles, complete LAN options and legendary service and support, and you have customized computing solutions you can't get anywhere else – at any price!

Do-it-yourself ease and convenience for any upgrade!

The secret is our ZIF (Zero Insertion Force) socket. No prying and pushing. No special tools needed to handle delicate chips. Simply release the lever and effortlessly lift out the old processor. Place your new processor in the socket and press the lever down. Presto... incredible new speed! (You can even use the old processor to upgrade another ZXP system!)

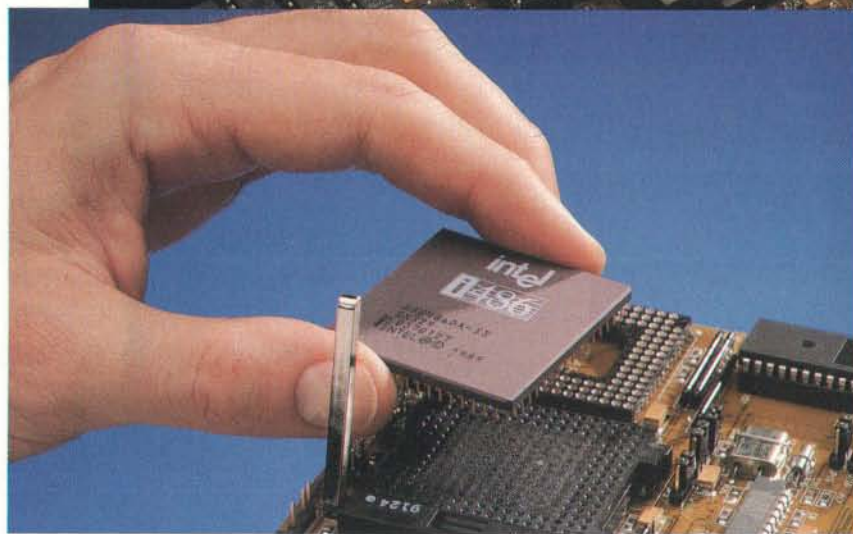

Elegance ZXP Systems End The 486 Confusion!

Northgate ZXP systems end your uncertainty about 486 technology. Unlike others, the Northgate ZXP systems let you maximize Intel®'s full range of upgradable CPU's – you can use any of them!

You can specify a 486SX/16 for your workstations. Later, upgrade them to SX/25...DX/33...DX/50 and Intel's DX2/66 when available.

Our expert sales team will help you decide which processor is best

for your present applications. Then, relax. No matter what your future needs are, Northgate has you covered. Our revolutionary engineering lets you upgrade your system and give it sizzling new speed – in just seconds!



upgradability with lift-a-lever ease!



Tower case for maximum expansion and for use as a file server! Everything about this case says "power." You get a 220 watt switching power supply and eight expansion slots – easily handles three exposed and four internal 5.25" half-height devices, too.

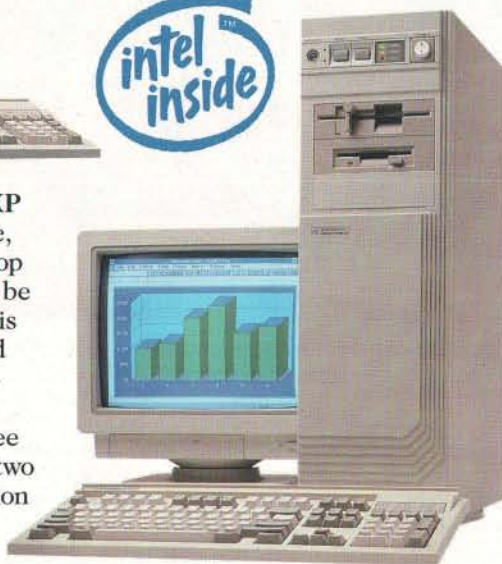

To get all the advantages of ZXP technology and conserve space, Northgate's space saving desktop case is your solution. But don't be misled by its compact size. This system delivers pure power and has seven expansion slots. Features a whisper-quiet 200 watt power supply and room for three exposed 5.25" half-height and two exposed 3.5" devices – expansion is a breeze!



Elegance ZXP 486/33 Configuration

- Intel 80486DX/33 processor
- 4MB RAM; expands to 32MB
- 64K cache
- 100MB hard drive
- 1.2MB 5.25" and 1.44MB 3.5" floppy drives
- One 8-bit and six 16-bit expansion slots
- Integrated IDE hard drive and floppy drive controller
- One parallel and two serial ports
- Space-saving desktop case
- 14" SVGA color monitor
- Northgate 101S keyboard
- MS DOS 5.0 and QBasic
- Microsoft® Windows™ 3.1 and mouse
- DiagSoft™ QA Plus™ system diagnostic/performance software
- FCC Class B certified

\$2749

Lease as low as \$94.01/month*

Step up to even greater expansion capability! Northgate's full-size desktop case is your best choice when space is no object. A 200 watt power supply provides plenty of power for your toughest applications. Expansion capacities include eight expansion slots plus space for three exposed and two internal 5.25" half-height devices.

Other ZXP Systems Configured As Shown

486SX/16

\$2349

Lease as low as \$86.91/month*

486SX/20

\$2399

Lease as low as \$88.76/month*

486SX/25

\$2499

Lease as low as \$86.47/month*

486DX2/50

\$2949

Lease as low as \$100.86/month*

Add \$50 For Full-Size Desktop Case

Add \$150 For Elegance Tower Case

And the ZXP systems are backed by world famous Northgate tech support, customer service and warranty programs with up to three years of extended warranty available (optional). Need tech help? Just call us 24 hours a day, every day. And you'll get a knowledgeable tech specialist – no machines!

No matter how you look at it, Northgate offers you the best combination of hardware and support money can buy. *Give us a call today!*

Call for complete custom configuration information.
800-345-8709

Major corporations, volume purchasers and government agencies call National Business Accounts: 800-545-6059

GSA# GS00K91AGS5193 PS01
Keyboard Sales: 800-526-2446

Charge it to your Visa, MasterCard, Discover, American Express or Northgate Big 'N' card.



7075 Flying Cloud Drive, Eden Prairie, MN 55344

Watch the Weather with DOS

Just how blustery is it outside? Plug the WS-10 WindStation into your PC's game port and find out. An exterior-mounting wind vane/anemometer and software, the WS-10 measures local weather patterns and displays them in color or monochrome on your monitor. Average wind speed, direction, and peak gust value within the range of 0 to 125 mph are shown with a resolution of ± 1 mph for speed and $22\frac{1}{2}$ degrees for direction. Optional outside-temperature measurement capability for 24-hour extremes and wind-chill values is available. You can store historical data on disk for use with most spreadsheet programs.

Price: \$99.50; with temperature-measurement capability, \$129.50.



Contact: WeatherPort, Inc., 12036 Nevada City Hwy., Grass Valley, CA 95945, (800) 992-8110 or (916) 274-8100; fax (916) 273-6429.

Circle 1287 on Inquiry Card.

Two Presentation Systems

A combined Super VGA and digital video adapter for multimedia productions on your PC, SNAPplus captures live or still video



WindStation lets you be a weather watcher at your computer.

in 24-bit true color on your monitor and integrates the images with computer-generated text and graphics. You can capture images from any video source and scale, position, process, or overlay them with your graphics. Also, you can integrate animated images from programs such as Autodesk Animator Pro into live or still video and paste the resultant image into other Windows applications. SNAPplus supports NTSC, S-Video, and RGB. The SNAPshot Desktop Video Software utility ships with the adapter.

Price: \$1295.

Contact: Cardinal Technologies, Inc., 1827 Freedom Rd., Lancaster, PA 17601, (800) 233-0187 or (717) 293-3000.

Circle 1288 on Inquiry Card.

VideoShow HQ displays video from any source through a dynamic video window that can be any size and positioned anywhere on

the screen. You can move the window—which can be any shape—around the screen, enlarging it and shrinking it as you desire.

The integrated multimedia system offers full-motion and live video, stereo sound, photographic images, animation, and computer graphics. VideoShow HQ can import images created with most presentation software packages. The 6-pound modular system connects directly to your monitor or other output device for output as RGB, VGA, composite NTSC, S-Video, and PAL. An optional ARC (Advanced Remote Control) unit puts a full-color 3-inch LCD in your hand for private viewing.

Price: \$4999; optional ARC, \$1299.

Contact: General Parametrics Corp., 1250 Ninth St., Berkeley, CA 94710, (510) 524-3950; fax (510) 524-9954.

Circle 1289 on Inquiry Card.

Provide a Safety Net for Your LAN

A comprehensive software security system, StopLight provides access control; audit tracking; protected files, directories, and peripherals; and real-time virus prevention for your network. The Windows-compatible system supports multiple user log-ins per PC, protecting the computer at boot-up by requiring a valid log-in to gain access to the hard drive. Other security is provided by keyboard lock protection and the optional SmartCard reader. StopLight has a total memory overhead of 9 KB, safe hard-drive locking, partition table mirroring, and secure recovery tools.

Price: \$89 to \$295 per PC.

Contact: Safetynet, Inc., 14 Tower Dr., East Hanover, NJ 07936, (908) 851-0188; fax (908) 276-6575.

Circle 1290 on Inquiry Card.

A DES Dongle

The GL306060 Hardlock-DES parallel port adapter incorporates an application-specific IC that encrypts and decrypts data using the DES algorithm. The GlenDES chip features nonvolatile 8-byte internal EEPROM for storing the DES key. The Hardlock-DES, which connects directly to your PC's printer port, is transparent to normal printer operation. The unit's key-management features support private and public key modes.

Price: \$149.

Contact: Glenco Engineering, Inc., 270 Lexington Dr., Buffalo Grove, IL 60089, (708) 808-0300; fax (708) 808-0313.

Circle 1291 on Inquiry Card.

SORRY, HP. NEC WINS BY A TECHNICAL KNOCKOUT.

Introducing the lowest priced
fully-configured PostScript® printer.



THE NEC SILENTWRITER® MODEL 95

Talk about flooring the competition! Now there's a laser printer that's fully configured for both MS-DOS® and Mac® platforms... that delivers remarkably sharp output... and does it all at the lowest price on the market. The fact is, the NEC Silentwriter Model 95 packs more features than any laser printer in its class. Yet it starts at a price the others bargain down to! That's just plain honest. Even more important, it lets you concentrate on what counts: great output that makes you look great. Look, you know your business. Make your own comparisons. Check specs, prices, quality. Once you're ready to hand down your decision... you'll agree it's no contest.

FEATURES	Hewlett-Packard LaserJet III	Okidata Ol830	Texas Instruments MicroLaser Turbo	NEC Silentwriter Model 95
PostScript Language Level 2	N/A	N/A	Yes	Yes
LaserJet III Emulation (PCL5)	Yes	No	No	Yes
Automatic Emulation Switching	No	Yes	Yes	Yes
Enhanced Resolution Technology	Yes	No	No	Yes
Automatic Interface Monitoring	No	No	No	Yes
Envelope Feeder & Cassette	No	No	No	Yes
Suggested List Price	\$2495	\$1995	\$2249	\$1749

For more information, dial 1-800-NEC-INFO (in Canada, 1-800-343-4418). For immediate information via fax, call NEC FastFacts at 1-800-366-0476 and request #SWM95.

PostScript is a registered trademark of Adobe Systems, Inc. Silentwriter is a registered trademark of NEC Corp. MS-DOS is a registered trademark of Microsoft Corp. Mac is a registered trademark of Apple Computer, Inc. LaserJet is a registered trademark of Hewlett-Packard, Inc. MicroLaser is a trademark of Texas Instruments, Inc. Okidata is a registered trademark of Oki America, Inc. © 1992 NEC Technologies, Inc.

Because  is the way you want to go.

NEC

See Fox *RUN*.

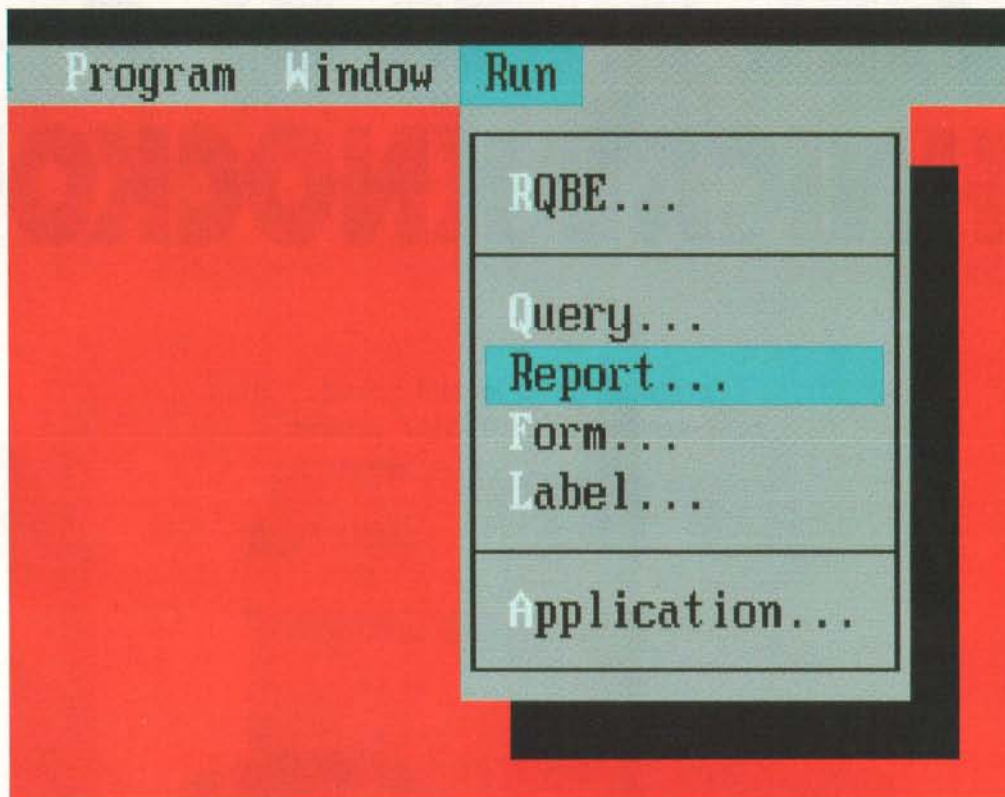

We've just added a new word to the database vocabulary: *RUN*.

And it can make you a master of your database management universe. Even if you've never managed a database before.

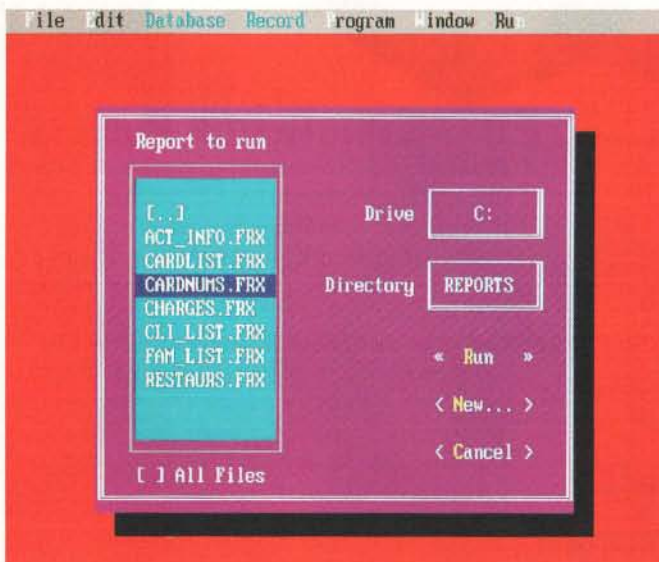

The most powerful PC DBMS available is now the easiest to use, too: FoxPro™ 2.0.

Pick *Run* from the FoxPro 2.0 main menu and you have instant access to your information. Click on *Report*, choose the name of the report you want, and it's yours. Do the same for queries, forms, labels and applications.

For answers on-the-fly, pick *RQBE* (Relational Query By Example) and get a simple interface for creating custom queries quickly and easily. Unlike other query systems, *RQBE* lets you browse the information or create instant databases, reports, labels, or business graphs (with optional FoxGraph or other graphic program).

Custom systems are easy, too.

You create quick reports, forms, labels and applications by clicking on the *New* button in the dialog box instead of picking a name from the list.

Then using our simple tools, you build forms containing buttons, lists, check boxes, text regions and data fields. Reports with headers, footers and

subtotals. And even complete applications.

All without any programming.

So while it's the most powerful DBMS you can get today, it's ideal for small businesses and large. In industry or government. For invoicing and inventory control, order entry and accounting, and all your data handling needs.

FoxPro is the state-of-the-database-art.

FoxPro 2.0 is the object-oriented, event-driven DBMS programmers have been waiting for, too.

We've added over 100 new and enhanced commands. 4GL (Fourth Generation Language) tools for creating screens, reports and menus as reusable application objects. And the ability to attach entry and exit procedures to fields, forms and windows for pre- and post-processing.

We've integrated SQL SELECT, INSERT and CREATE TABLE into the language, with the ability to use RQBE for creating SELECT statements you just cut and paste into your application code.

We've added a project manager on top of our debugger, trace window, and editor.

We provide an Application Program Interface (API) that links to C or assembler function libraries (Library Construction Kit optional).

And we offer an optional Distribution Kit to distribute your applications royalty-free.

Today's best choice for upgrading or downsizing critical database applications.

FoxPro is devastatingly faster than competitive products (see chart¹—the difference is even greater in single-user tests), and has out-queried even mainframe databases like Oracle, XBD and DB2, using our patent-pending Rushmore™ query optimization.

It's backward compatible with dBASE III+/IV and earlier versions of

Fox software to protect your investments in hardware, software, training, and support.

And in the few months since its release, FoxPro 2.0 has swept the awards. Best DOS Application - Spring COMDEX. Technical Excellence -PC Magazine. Award of Excellence -Byte. Best DBMS -Data Based Advisor. And many, many others from both editors and users of FoxPro 2.0.

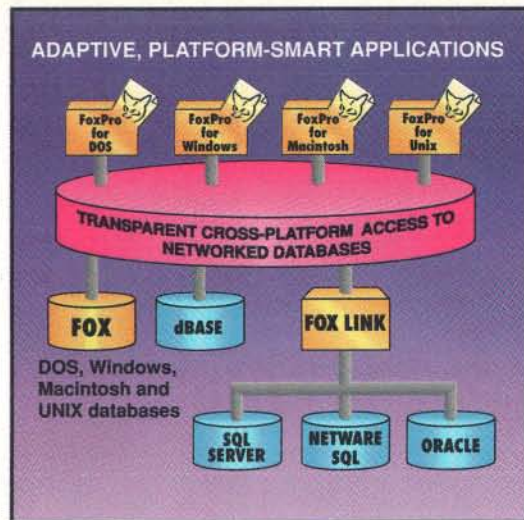

Applications developed today with FoxPro for DOS, unlike other databases, will be able to run under Windows and SCO/UNIX and on the Macintosh when we release our new versions of FoxPro later this year.

Get a headstart on tomorrow today.

Today, FoxPro exchanges data with FoxBASE+ on Macs and on PCs running SCO UNIX. Later this year, FoxPro will be available for Windows, UNIX, and the Mac, with access to Netware SQL, SQL Server, and Oracle databases.

And applications written using FoxPro's 4GL tools will be platform-adaptive, so DOS or Windows applications will run on UNIX or the Macintosh, and vice-versa.

Which means you can get a headstart on your future by starting your Windows, Mac or UNIX development now with FoxPro on your current DOS PCs.

It comes with a 60-day money-back guarantee.

So pick up a copy of FoxPro 2.0 at your nearest computer or software store. Try it out for 60 days, then if you don't like it, just return it to your dealer for a full refund.

But we think you'll agree with Byte magazine in its 1/92 review of dBASE: "...FoxPro is the better product."

Call 1-800-837-FOX2 today.

(419-874-0162 from Canada)

Ask for Lit Pak BYT601

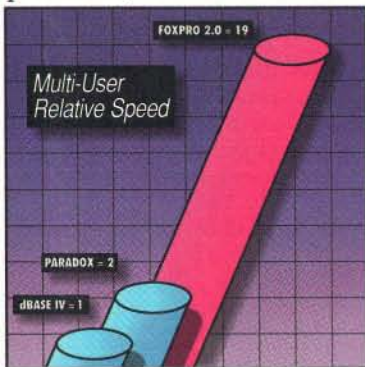

No one comes close to FoxPro's multi-user query response.

¹Query benchmark tests performed by Micro Endeavors, Inc. (215) 449-4680, from Data Based Advisor 8/91. FoxPro, FoxBASE+ and FoxBASE+Mac are trademarks of Fox Holdings Inc.; other products are not. © Fox Holdings Inc. 1992.

A Pocket Fax/Modem for Laptops

The 5-ounce Megahertz V.32 Pocket Fax/Modem features 9600-bps Group 3 send and receive fax capabilities. With V.42bis data compression, the unit can provide up to 38,400-bps throughput. MNP level 5 error correction is also included.

The Pocket Fax/Modem plugs into the nine-pin serial port of a laptop, notebook, or desktop computer and is bundled with MagicSoft's MTEZ with ExpressFax, an integrated fax and data communications software package. A built-in speaker lets you listen to your connections and monitor calls. A carrying pouch, a detachable phone cable, an AC adapter, and batteries are included. An optional Auto-Sync capability provides simulation of synchronous connections.

Price: \$799.

Contact: Megahertz Corp., 4505 South Wasatch Blvd., Salt Lake City, UT 84124, (800) 527-8677 or (801) 272-6000; fax (801) 272-6077.

Circle 1292 on Inquiry Card.

Easy Faxing on Your Network

Advanced EZ-Fax for Networks 3.53, a 9600-bps LAN fax card with LAN fax server and workstation software, is Hewlett-Packard LaserJet and Windows 3.0 compatible. You create and transmit faxes from within any DOS application just as if you were creating and printing a document. EZ-Fax intercepts the print job and transmits



The V.32 Pocket Fax/Modem goes well with laptops.

the document as a laser-quality fax. The fax card is certified for use with NetWare and LANtastic networks.

Version 3.53 has several new features. Client notification of transmit status lets the EZ-Fax server pass a message back to the sending client notifying of the transmission status. The accelerated HP laser graphics feature, G3F FaxMerge Tag, supports full-page inclusion of fax file documents without requiring conversion to process the documents, thus decreasing the time it takes to ready a fax for transmission. Advanced EZ-Fax fonts are stored in 200-dpi resolution.

Price: AVS96, for up to eight stations, \$1399; AVL96, unlimited stations, \$1799.

Contact: Calculus, Inc., 1761 West Hillsboro Blvd., Suite 404, Deerfield Beach, FL 33442, (305) 481-2334; fax (305) 481-1866.

Circle 1293 on Inquiry Card.

SunNet Manager Meets AppleTalk

An extension to SunNet Manager Software, Apple AgentMan from Information Presentation Technologies puts AppleTalk devices under the purview of the networking software. Two basic categories of functionality are provided by Apple AgentMan.

The discovery function automatically locates all AppleTalk devices on your network. It collects information about each device (e.g., the device type, name, and AppleTalk socket the device is on) and information such as AppleTalk zone name and network number for each network segment. Apple AgentMan then gives you a detailed report that instantly updates the SunNet Manager database.

Apple AgentMan's proxy agents report and send alarms when network conditions change. Corresponding to SunNet Manager's agents, these agents collect statistics to analyze network performance and the status of specific devices.

Price: \$595.

Contact: Information Pre-

sentation Technologies, Inc., 555 Chorro St., San Luis Obispo, CA 93405, (800) 233-9993 or (805) 541-3000; fax (805) 541-3037.

Circle 1294 on Inquiry Card.

Intelligent Hub Focuses on Reliability

The Focus Series intelligent hub line uses up to four token-ring hub modules and one network management module in a five-slot chassis in a peer-to-peer arrangement. This setup lets the hub modules function even when the management module is not operating.

Distributed recovery intelligence on each token-ring hub module consists of dedicated hardware and software that detects and automatically removes any faulty nodes attached to that module. When searching for an error, all hub modules search throughout the network in parallel. Other dedicated hardware on each module provides intelligent jitter cancellation, which removes any accumulated jitter of any frequency on the network. This approach lets you mix any combination of untwisted-pair, shielded-twisted-pair, and fiber-optic wiring on your network.

Additionally, each token-ring lobe port incorporates retiming via its own custom VLSI phase-locked-loop chip, providing a dedicated phase-locked loop. Each token-ring hub module supports as many as 20 users.

Price: Starts at \$2500.

Contact: Star-Tek, Inc., 71 Lyman St., Northborough, MA 01532, (800) 225-8528 or (508) 393-9393; fax (508) 393-6934.

Circle 1295 on Inquiry Card.

Introducing Z-NOTE. The future is built in.



320L	325L	325Lc
i386®SL-20 MHz	i386SL-25MHz	
60MB HDD	85 or 120MB	120MB
10.0" (9.5" v) VGA black-on-white display upgradeable to active-matrix color		8.4" VGA color
5.9 lbs* *incl. nickel metal-hydride battery		6.5 lbs*
4 hours continuous power, max 10 hours under Z-NOTE Premier System Management.™ Expect about 1/3 less with color.		
<i>ETHERNET NETWORK-READY</i> Novell NetWare, Microsoft LAN Manager, and Banyan VINES client shells		
<i>WINDOWS-READY</i> MS-DOS® 5.0 with APM/Microsoft Windows 3.1 Logitech TrackMan Portable Mouse		
<i>UPGRADE OPTIONS</i> Memory, BIOS, HDD, FDD, Co-Processor, Display		

320L \$2599 325L \$3099 325L \$3599 325Lc \$5299
Model 85 Model 120

Generations Ahead.

While the others are busy imitating the SL-notebook design we shipped last July, Zenith Data Systems is thinking two generations ahead. Our new Z-NOTE brings a new genius to power management: *over four hours* of non-stop high-performance computing power. And our new "lid rest" feature allows you to close down without shutting down. It's simple, and it's just the beginning.



Who Needs A Docking Station?

Just snap on the optional, inexpensive READYDESK™ Port Replicator and you have instant access to all your office peripherals. It's pretty neat. It's Z-NOTE.

Practice Makes Perfect.

There's no more-thoroughly-thought-out SL notebook on the market. Microsoft Windows™ 3.1 is pre-installed. The Logitech® TrackMan® Portable Mouse is included. LCD/CRT video is simultaneous. And the optional data/fax modem works worldwide. You won't get that kind of thinking from the rookies. It's called Thinking Ahead. And we're used to it.



Call 1-800-523-9393.

Reseller prices may vary. But call ahead. We'll tell you how we can guarantee prices on all four models. When you're Thinking Ahead, you think of everything.

Notebooks Meet Networks.

The Z-NOTE introduces notebooks to networking. *Built-in* networking. Believe it. We've put Ethernet on the motherboard. And we've pre-installed client shells for Novell NetWare®, Microsoft® LAN Manager,™ and Banyan® VINES®. Take your pick.

We've Seen The Future And It's In Color.

Our new active-matrix color display is a knockout. And the real beauty of it is that you can start with our high-contrast black-on-white model and upgrade to color in the future. In minutes. It's worth waiting for.

Resellers determine their own pricing which may be higher or lower than Zenith Data Systems advertised prices. All prices and specifications are subject to change. Prices are for models shown, in U.S. dollars. Shipping, handling, and applicable sales taxes not included in the price.

Z-NOTE, READYDESK and Premier System Management are trademarks of Zenith Data Systems Corporation. Microsoft, LAN Manager, MS-DOS, Windows and the Ready-To-Run logo are trademarks of Microsoft Corporation. Logitech and TrackMan are trademarks of Logitech, Inc. The Intel Inside logo and i386 are trademarks of Intel Corporation. NetWare is a trademark of Novell, Inc. Banyan and VINES are trademarks of Banyan Systems, Inc. Copyright © 1992 Zenith Data Systems Corporation.



ZENITH DATA SYSTEMS

A Bull Company

Thinking Ahead.

DOES YOUR DATABASE GIVE



YOU SALES REPORTS,



INVENTORY AVAILS,



PRICE LISTS, CATALOGS



DIRECTORIES, FINANCIAL



REPORTS, RATE GUIDES,



TABLES, AND SCHEDULES ?

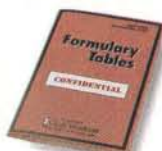

CUSTOMIZED? ON DEMAND?

NOT WITHOUT THIS.

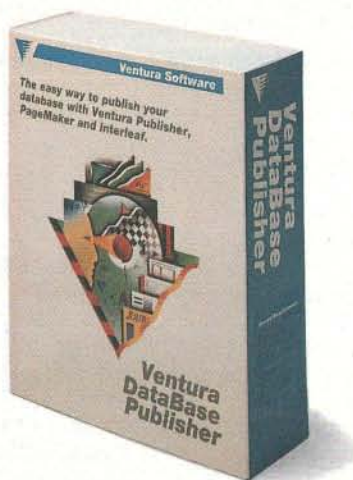

Because this is Ventura DataBase Publisher.®

Without it, your database printouts are just a pile of greenbar. Or you've had to wait days or weeks for a programmer.

With it, you can extract the database information you need. Convert it. Format it. And publish it with Ventura Publisher,® PageMaker, or Interleaf — all with push-button simplicity... all without programming.

Ventura DataBase Publisher gives you the flexibility to publish database documents when you want. With

only the information you want. Any way you want.

If you need to transform data into information, then Ventura DataBase Publisher is the one product you shouldn't be without.

Don't go without. Make database publishing simple, automatic, and push-button quick. See your local Ventura dealer, or call **(800) 822-8221**.

Ventura DataBase Publisher.

Database publishing doesn't get any easier than this.



Ventura
Software Inc.
A Xerox Company

15175 Innovation Drive, San Diego, California 92128 • (800) 822-8221

© 1992 by Ventura Software Inc. All rights reserved.

Circle 170 on Inquiry Card (RESELLERS: 171).

Make Your Applications Network-Savvy

Programmers developing Windows, DOS, or Unix software now have a single tool to add network capability to applications: ND (NetWorks Developer). ND lets you write network software using a common API. Regardless of your platform, the programmatic interfaces to the NetWorks transport system are the same. The system includes agents for creating peer-to-peer and client/server support. You can use ND with most C, Pascal, or COBOL programming tools.

ND's developer also offers a Windows DDE utility for use over networks. According to Symbiotics, NetWorks Connect extends the hot-linking functions available in Windows, allowing automatic hot links to exist over any PC network.

Price: ND, \$2495; NetWorks Connect, \$595 for two-node version.

Contact: Symbiotics, Inc., 725 Concord Ave., Cambridge, MA 02138, (617) 876-3635; fax (617) 876-0157.

Circle 1311 on Inquiry Card.

No-Compromise Cross-Platform Development

Using recompilable master source code and families of reusable software modules, the Universal Component System offers true platform independence to software programmers. According to its developer, UCS lets you build applications for one platform and port them to other platforms without reprogramming and without losing speed or functionality.

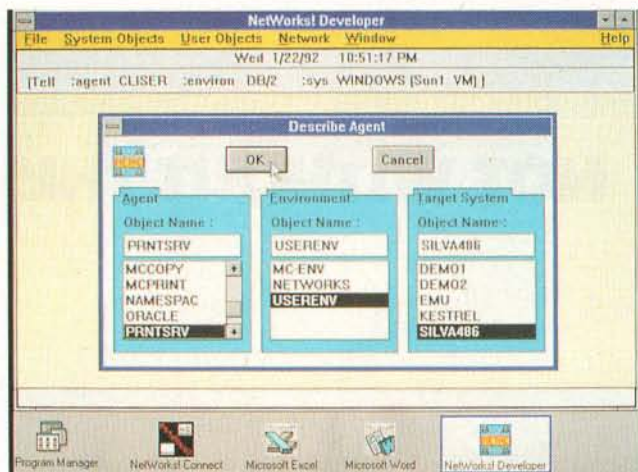

The ND agents let you interface your application to the ND translation layer.

UCS speeds up the translation process by using a technology called ADS (application-driven scalability). As you build an application, ADS lets you select the appropriate family of software components and configure each component for just the features you want in the target application. UCS supports all system services, including run-time modules and dynamic linking, not just interfaces. You can incorporate features available on only selected platforms, such as DLLs, into all your target applications.

The UCS API can accommodate evolving architectures such as pen-based and 32-bit. UCS is currently available in Windows and Macintosh editions, with Unix versions in the works.

Price: Depends on configuration.
Contact: Software Transformation, Inc., 1601 Saratoga-Sunnyvale Rd., Suite 100, Cupertino, CA 95014, (408) 973-8081, ext. 700; fax (408) 973-0989.

Circle 1312 on Inquiry Card.

A Graphics Library for C++ Tools

Borland C++ with Application Frameworks and Turbo C++ for Windows take on new power, thanks to The Whitewater Group's OGC (ObjectGraphics for C++). OGC is an object-oriented graphics library that lets you use the Borland tools to create platform-independent support for graphics. OGC masks the graphics engine within Windows and lets you create and manipulate tool objects such as pens and brushes to control the appearance of graphics images. OGC is an extension of the ObjectWindows class library included in C++ with Application Frameworks and Turbo C++ for Windows. Application code developed under one environment is fully portable to any environment where OGC is available.

Price: \$195; with source code, \$390.

Contact: The Whitewater Group, 1800 Ridge Ave., Evanston, IL 60201, (708) 328-3800; fax (708) 328-9386.

Circle 1313 on Inquiry Card.

Reuse Your Windows and OS/2 Objects

With VZ Programmer, developers of C and C++ applications can reuse software components in building programs. Version 2.1 of the programming tool features a GUI toolkit. VZ Programmer's component library is an extensible set of compound objects that let you group multiple application or GUI objects into a single component. The VZ Programmer tool lets developers of either Windows or OS/2 applications build cross-platform compatibility into their programs.

Price: Windows version, \$595; OS/2 version, \$995.
Contact: VZ Corp., 175 South Main St., Suite 1550, P.O. Box 3683, Salt Lake City, UT 84110, (801) 595-1352; fax (801) 328-4404.
Circle 1314 on Inquiry Card.

Build Rule-Based Systems Automatically

Aimed at C and C++ programmers who need to integrate rule-based systems into their software, Knowledge Shop 2.0 offers a host of development tools designed to reduce the complexities of such programs. DOS-based Knowledge Shop lets you construct a model of the problem via node linking. You can incorporate defining rules within that model and then generate source code.

Price: \$495.
Contact: Decision System Software, 160 West St., Cromwell, CT 06416, (203) 632-7570; fax (203) 635-3839.

Circle 1315 on Inquiry Card.

GO FIGURE!

DesignCAD 2D. Like Leonardo da Vinci's concept of a rotary blade aircraft, it is ahead of its time, not only in technology, but also in cost and value.

DesignCAD 2D is only \$349, and it has more and better features than the other CAD programs that cost \$3,000!

And, if you're ready for a three dimensional CAD program, there is the state-of-the-art DesignCAD 3D . . . for only \$499!

So, how come theirs costs several thousand dollars and ours costs a couple hundred? Go figure. (Why do you think the Mona Lisa is smiling like that?)

*Your product designed with DesignCAD?
Let us know, and maybe we'll put it in one of our ads.*

For a free demo disk and 16 page color brochure, contact:

 **American**

Small Business Computers, Inc.
One American Way • Pryor, Oklahoma 74361
(918) 825-4844 • FAX (918) 825-6359

European Headquarters:
102 Rue La Fontaine • 75016 Paris, France
Phone 331 4520 6540 • FAX 331 4520 6539

Other offices in:
Athens • Barcelona • Brussels • Bucharest • Istanbul • London
Mexico City • Paris • Prague • Sao Paulo • Tokyo • Warsaw

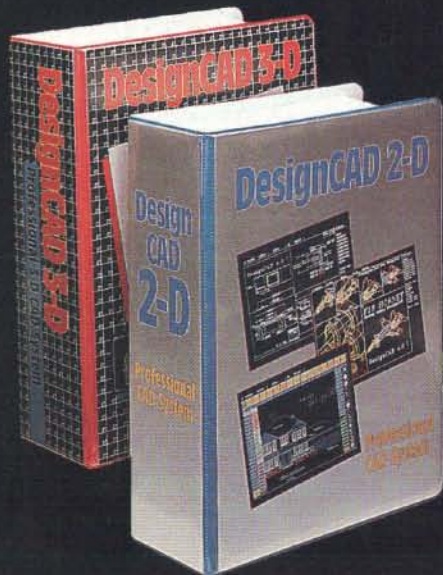

CAD/CAM Software



December 11, 1990
DesignCAD 2D, version 3.1



December 17, 1991
DesignCAD 3D, Version 3.0

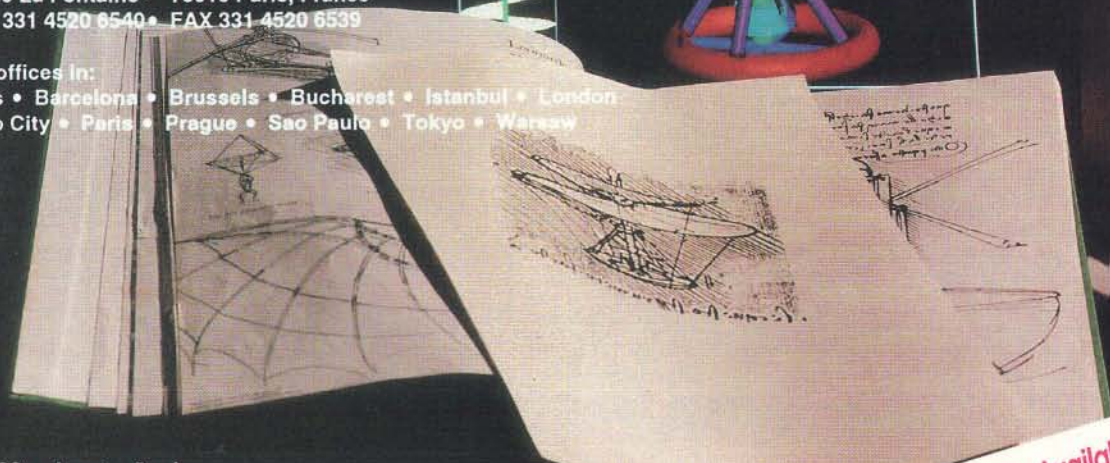
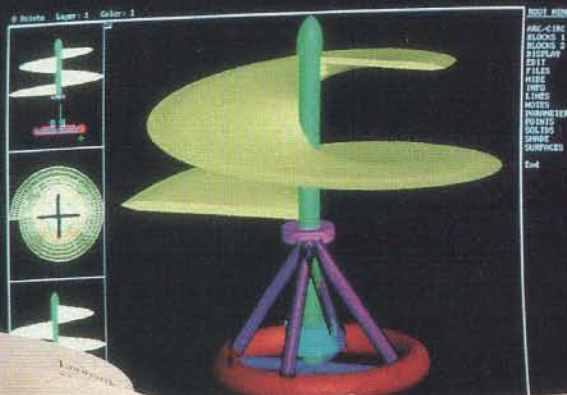

Circle 80 on Inquiry Card.

Also Available for Macintosh

WE'RE ONLINE. AND IN LINE WITH YOUR OBJECTIVES.

BUSINESS WEEK

AEROSPACE DAILY

AIRPORTS

AVIATION DAILY

AVIATION WEEK &
SPACE TECHNOLOGY

BIOTECHNOLOGY NEWSWATCH

BYTE

CHEMICAL ENGINEERING

CLEAN-COAL/SYNFUELS LETTER

COAL WEEK

DATA COMMUNICATIONS

ELECTRIC UTILITY WEEK

ENGINEERING NEWS-RECORD

HAZARDOUS WASTE BUSINESS

INDEPENDENT POWER REPORT

INDUSTRIAL ENERGY BULLETIN

INSIDE ENERGY/
WITH FEDERAL LANDS

INSIDE F.E.R.C.

INSIDE N.R.C.

INTEGRATED WASTE MANAGEMENT

LAN TIMES

NUCLEONICS WEEK

POSTGRADUATE MEDICINE

PLATT'S INTERNATIONAL
PETROCHEMICAL REPORT

PLATT'S OILGRAM NEWS

PLATT'S OILGRAM PRICE REPORT

S&P'S EMERGING & SPECIAL
SITUATIONS

S&P'S REVIEW OF BANKING
& FINANCIAL SERVICES

S&P'S REVIEW OF SECURITIES
& COMMODITIES REGULATION

SECURITIES WEEK

TECH TRANSFER REPORT

UTILITY ENVIRONMENT REPORT

THE WEEKLY OF BUSINESS AVIATION

UNIXWORLD

AND MORE...

When you need business information, why not get the total story, instantly! Word for word. The McGraw-Hill Publications Online database gives you just that. Unedited, full-text retrieval (except graphics) of articles exactly as they are published in McGraw-Hill magazines and newsletters.

Now you can get information on companies, people and products on any topic — pertaining to one particular industry, or search the entire McGraw-Hill library (over 35 leading publications online) for diverse editorial perspectives. Only McGraw-Hill, the world's foremost business information publisher, can deliver it all so completely — immediately! McGraw-Hill unabridged.

Access an entire universe of business information. Go online with our line. McGraw-Hill Publications OnLine. For more information, including our latest list of publications, contact Andrea Broadbent at (609) 426-5523. Or fax this coupon to (609) 426-7352.

Or send it to the address below.

Available through Dialog®, Dow Jones News/Retrieval®, NewsNet® and Nexis®.

McGraw-Hill PUBLICATIONS ONLINE



Princeton-Hightstown Road
Hightstown, NJ 08520 U.S.A.

Please send me the complete 1992 list of your publications online.

BY

Name _____

Title _____

Company _____

Address _____

City _____

State _____

Zip/Postal Code _____

Country _____

Tel. _____

GO ON LINE WITH OUR LINE.

Quattro Pro Turns 4.0

NetWare awareness, greater support for Lotus 1-2-3 files, and click-bang access to often-used tasks are just a few of the goodies offered in version 4.0 of Quattro Pro, the DOS spreadsheet from Borland.

The Intelligent Graphs feature performs one-step statistical analysis and data graphing. The Optimizer, a new multivariate solver, lets you specify a goal in a spreadsheet model, and the solver will then change variables until the specified goal is reached. The customizable SpeedBar provides fast access to commonly used functions, macros, and commands.

NetWare operations can be performed directly from within Quattro Pro 4.0, including automatic log-in and drive mapping. If you need to access a spreadsheet on the server, you can click on the file's icon to retrieve it. The program's Audit tool performs spreadsheet structure analysis and illustrates relationships between cells. Rounding out the upgrade's list of improvements are background printing through a new print manager, the use of Bitstream Font Scaling Technology, and the ability to import Impress, Lotus 1-2-3 WYSIWYG (.FMT and .FM3), and Allways files.

Price: \$495.

Contact: Borland International, 1800 Green Hills Rd., Scotts Valley, CA 95067, (800) 331-0877 or (408) 438-8400; fax (408) 439-9119.
Circle 1316 on Inquiry Card.

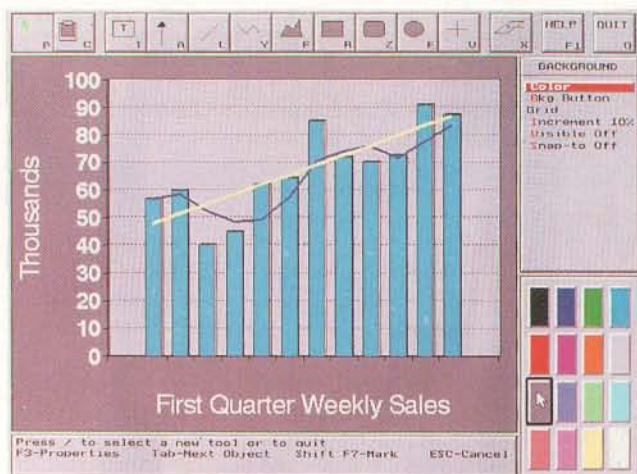

Quattro Pro's Intelligent Graphs feature performs statistical analysis on spreadsheet data and graphs the analysis without changing the underlying data. You can establish a live link between the spreadsheet and the graph.

Small Business Accounting for Nonaccountants

QuickBooks is an accounting solution for small-business owners who want to spend their time running their business, not learning accounting. According to Intuit, DOS users can use this program without knowing double-entry accounting. QuickBooks manages accounts receivable and payable and produces checks, invoices, and reports for businesses with fewer than 20 employees and under \$5 million in yearly sales.

QuickBooks monitors accounting information as it is generated by activities such as billing and check writing. Productivity features include credit-limit warning, transaction history reports, employee sales tracking, and automatic setup of different styles of business-related accounts (e.g., nonprofit).

Price: \$139.95.

Contact: Intuit, 155 Linfield Ave., P.O. Box 3014,

Menlo Park, CA 94026, (800) 624-8742 or (415) 322-0573; fax (415) 329-2785.
Circle 1317 on Inquiry Card.

A Financial Calculator for PenPoint

In conjunction with the recent shipment of Go Corp.'s PenPoint operating system, PenStuff has released a financial calculator for use on pen-based PCs.

The PenStuff RPN12C+ calculator performs simple and compound interest calculations, amortization, statistics, reverse Polish notation data entry, and other financial functions. Using PenPoint's embedded results feature, you cut RPN12C+ data and paste it into other applications.

Price: \$59.

Contact: PenStuff, Inc., P.O. Box 18372, Rochester, NY 14618, (716) 461-3182; fax (716) 256-6236.
Circle 1318 on Inquiry Card.

Put an End to the Debtor's Blues

Blueprint 3.0 analyzes your income, fixed and variable expenses, and debt information and designs a budget covering everything you spend money on, from fast food to postage stamps to your mortgage. The system requires that you keep track of everything you spend in a checkbook-like register. Future versions of Blueprint will provide an on-line check register and check-writing capabilities.

Built into your monthly budget is a "roll-down" payment schedule to eliminate debts in the shortest amount of time possible. Roll-down means that as soon as you pay off one debt, you must apply its payment to another debt. By eliminating debts in this way, you can avoid huge amounts of interest payments. According to the company, it is possible to pay off long-term debts, such as a 30-year mortgage, in less than a third of the time originally scheduled for payment.

By setting up a budget that meets your particular needs, you don't lose anything. You can still use your credit cards to make purchases, but by following your plan and eliminating your debt early, you can start investing your money and planning for retirement.

Motivation is a major factor behind Blueprint's success. Reports on current debt status and your eliminated debt show you what you'll avoid paying in interest—true debt—if you stick to your budget.

Price: \$149.95.

Contact: Financial Freedom Enterprises, 132 North Woodruff, Suite B, Idaho Falls, ID 83401, (800) 669-8815 or (208) 529-2111; fax (208) 529-0680.

Circle 1319 on Inquiry Card.

Raima Database Engine Captures Fortune 500 With Record Speed



Now Raima Data Manager™
Formerly db_VISTA III

Accelerated Database Performance

Compared to conventional relational databases, retrieval of records can be 10—20—even 50 times faster with Raima Data Manager from Raima Corporation.

Propelling The Biggest Names In Business

Companies like General Motors, Hewlett-Packard, IBM, Eastman Kodak, Rockwell and others are using Raima Data Manager in their competitive environments. Today's most critical, most demanding applications demand the high performance of Raima Data Manager.

Powerfully Efficient Leading-Edge Technology

Raima's combined technology merges the flexibility of relational databases with the lightning speed and efficient

Raima Data Manager™

The High Performance DBMS

Specifications

Relational B-tree indexing. Network data model. Relational SQL query and report writer. Single & multi-user. Automatic recovery. Built-in referential integrity. Supports: VMS, QNX, ULTRIX, UNIX System V, Berkeley 4.2, AIX, SunOS, SCO, MS DOS, MS Windows, and OS/2. Most C Compilers and LANs supported.

Raima Corporation 3245 146th Place S.E., Bellevue, WA 98007 USA (206)747-5570 Fax: (206)747-1991
International Distributors: Australia: 61 2 419 7177 Belgium: 32 2 734 9818 Finland: 358 080405350 France: 33 1 46 09 27 84 Germany: 49 7022 34077; 49 214 91051 Italy: 39 49 829 1285
Japan: 81 33 865 2140 Mexico: 52 83 49 53 00 The Netherlands: 31 2159 46814 Norway: 47 2 38 48 88 Singapore: 65 334 0061 Sweden: 46 13 111 588 Switzerland: 41 64 517475
Taiwan: 886 2 552 3277 United Kingdom: 44 992 500919 Copyright ©1992 Raima Corporation, All rights reserved. Photo: Dale LaFollette

storage of the network model. With the program written entirely in C, you can "fine-tune" the Raima Data Manager engine for optimum performance in any application.

Put Yourself In Fast Company

Give yourself the competitive edge of Raima Data Manager:

- Speed—faster access to data
- Portability—supports most environments
- Royalty-free—increase your profits
- Source code availability—total programming flexibility
- Full Raima support services—including training

Whether you're writing a stand-alone DOS application, or one for UNIX accessing thousands of records, Raima Data Manager will put your application on the fast track. Race to the phone and call for more information!

In the U.S. or Canada, call: **1-800-DB-RAIMA**

In Washington state or international, call: **(206)747-5570**

Model Chemical Molecules Within Windows

Designed specifically for the research scientist, chemVision converts structured chemical data (i.e., numeric coordinates) into editable 3-D models. The Windows program lets you display, render, move, and scale 3-D molecular structures and provides tools for magnification, highlighting, characteristic identification, and tagging of molecular substructures.

In addition to chemVision's visualization capabilities, you can use the product to produce presentation-quality output. According to the developer, chemVision supports all Windows-compatible printers and plotters, including PostScript devices.

Price: \$299.

Contact: Molecular Arts Corp., 1532 East Katella Ave., Anaheim, CA 92805, (714) 634-8100; fax (714) 634-1999.

Circle 1320 on Inquiry Card.

Mathcad 3.1 Puts Handbooks On-Line

Mathcad 3.1 for Windows turns two engineering industry bibles into live, interactive resources. Machine Design and Analysis from the *Standard Hand-*

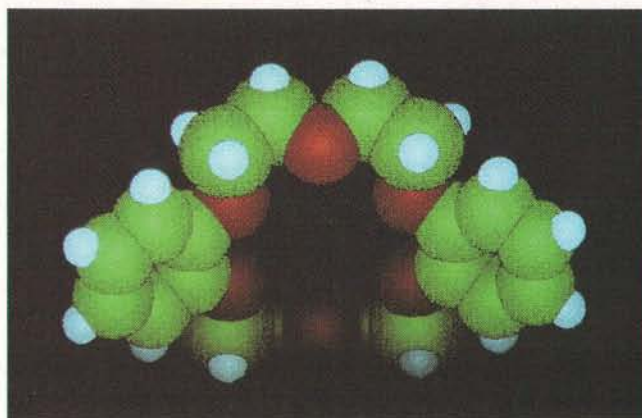

chemVision turns the numeric structural formula for Dibenzo-18-crown-6 into a 3-D representation of the molecule.

book of Engineering Calculation and *The CRC Materials Science and Engineering Handbook* are available on-line within the Mathcad upgrade. You can take equations, formulas, and diagrams from the handbooks, drop them into your document, and solve or change them within either the handbook or the document.

Machine Design and Analysis offers access to more than 125 calculation procedures, including shaft torque, horsepower, and speeds of gears. The CRC Handbook provides more than 140 tables, illustrations, and Mathcad plots. Included in the CRC Handbook are densities, melting points, and hardness and resistivities of ceramics and polymers. Also available on-line is MathSoft's guide to Mathcad, the Treasury of Methods and Formulas.

Mathcad 3.1 features OLE (Object Linking and Embedding) client status, color surface plotting, and user-definable grid lines. MathSoft will also offer Macintosh and Unix versions of the on-line handbooks.

Price: Machine Design and Analysis, \$99; CRC Handbook, \$149; Mathcad Treasury, \$99; all three on CD-ROM, \$199.

Contact: MathSoft, Inc., 201 Broadway, Cambridge, MA 02139, (617) 577-1017; fax (617) 577-8829.

Circle 1321 on Inquiry Card.

Graph and Present Your DOS Equations

TK Solver now offers presentation-quality reporting and user-programmable macros. Release 2.0 of the DOS program consists of a bundled library of tools for solving such problems as differential equations, statistical analysis, and algorithms. TK Solver lets you plug in known elements of an equation, and the program fills in the missing pieces (i.e., performs back solving).

Like its predecessor, TK Solver 2.0 has a graphing capability that provides

graphical representations of your equations. New to the program is Presentation View, an organization utility that lets you put together reports containing multiple sheets of equations, graphs, and text.

TK Solver links directly to symbolic math packages such as Mathematica and Derive. It also links to the company's Graphics 2000 package, a 3-D graphing and annotation program that has image-manipulation capabilities.

Price: TK Solver 2.0, \$595; Graphics 2000, \$395. **Contact:** Universal Technical Systems, Inc., 1220 Rock St., Rockford, IL 61101, (800) 435-7887 or (815) 963-2220.

Circle 1322 on Inquiry Card.

Equation Building for Mac and Windows

MathType 3.0 for Macintosh and Windows lets you build (but not solve) equations and merge them into word processing, desktop publishing, and other documents. Windows users will find that the upgrade provides support for OLE (Object Linking and Embedding), PostScript Type 1 fonts, and TrueType fonts. The Mac version also supports OLE and offers System 7.0 compliance, too. MathType 3.0 offers both Mac and Windows users a toolbar for storing frequently used equations and templates, a font/symbol storage facility, and the ability to save equations as EPS files.

Price: \$199.

Contact: Design Science, 4028 Broadway, Long Beach, CA 90803, (800) 827-0685 or (310) 433-0685; fax (310) 433-6969.

Circle 1323 on Inquiry Card.

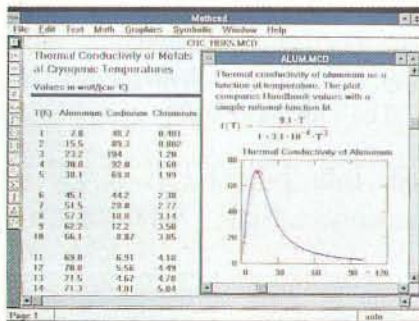

Using data provided by the CRC Handbook, you can determine the thermal conductivity of aluminum, graph it against the temperature, and use the resulting graph in your own document.

BYTE

INTERNATIONAL

MICROBYTES

100IS-3

FIRST IMPRESSIONS

A Fist Full of Fonts

100IS-7

Psion-Dacom Delivers One Modem for Europe

100IS-18

The Persistent POET Provides

Powerful OOP Data Storage

100IS-20

WHAT'S NEW

100IS-23

FEATURE

Build Yourself a SPARC Clone

100IS-43

RESOURCE GUIDE

100IS-56



SAMPLE CONFIGURATIONS
(excluding carriage and VAT)

£8,380

NetWare 3.11 for up to 100 users
(optional version for up to 250 users)
pre-loaded and ready to go with
Elonex PC-450F EISA File-server
50MHz 486DX2 CPU, 128k cache, 8MB RAM
(max 64MB), 1.4GB scsi hard disk, with 32-bit
caching control, 32-bit Ethernet card, 250W PSU.

£7,125

NetWare 3.11 for up to 50 users
pre-loaded and ready to go with
Elonex PC-433F EISA File-server
33MHz 486DX CPU, 128k cache, 8MB RAM
(max 64MB), 1.4GB scsi hard disk, with 32-bit
caching control, 32-bit Ethernet card, 250W PSU.

£6,410

NetWare 3.11 for up to 20 users
pre-loaded and ready to go with
Elonex PC-433F EISA File-server
33MHz 486DX CPU, 128k cache, 8MB RAM
(max 64MB), 1.4GB scsi hard disk, with 32-bit
caching control, 32-bit Ethernet card, 250W PSU.

£3,530

NetWare 2.2 for up to 10 users
(optional version for up to 50 and 100 users)
pre-loaded and ready to go with
Elonex PC-450B ISA File-server
50MHz 486DX2 CPU, 256k cache, 8MB RAM
(max 32MB), 400MB IDE hard disk, 5 drive bays
intelligent 16-bit Ethernet card, 150W PSU.

£2,296

NetWare 2.2 for up to 5 users
pre-loaded and ready to go with
Elonex PC-433B ISA File-server
33MHz 486DX CPU, 256k cache, 8MB RAM
(max 32MB), 200MB IDE hard disk, 5 drive bays,
intelligent 16-bit Ethernet card, 150W PSU.

**Heavy duty 600VA UPS with NetWare
monitor card and cable suitable for all
servers £770**

Elonex Network Stations

with Colour SVGA, 16-bit Ethernet card and boot ROM

PC-325XM	16k cache, 2MB RAM	£730
PC-333M	32k cache, 2MB RAM	£830
PC-340M	32k cache, 2MB RAM	£1,000
PC-420XM	8k cache, 2MB RAM	£900
PC-433M	64k cache, 2MB RAM	£1,200
PC-450M	64k cache, 2MB RAM	£1,550

Call Response Computer Maintenance
(081-965-3225) for a free on-site installation survey
and/or subsequent on-site support.

Elonex® is a registered trademark of Elonex plc.
NetWare is a trademark of Novell Inc, Unix is a
trademark of AT&T. 486SX, 486DX are trademarks
of Intel Corp. All items are sold subject solely to
Elonex's terms and conditions. Prices and speci-
fications may be subject to change without notice.

Tel 081-452 4444

Fax: 081-452-6422

Elonex plc, 2 Apsley Way, London NW2 7LF

Tel (0274) 307226

Fax: (0274) 307294

Elonex plc, 7-9 Campus Road,
Listerhills Science Park, Bradford BD7 1HR

Tel (1) 40.85.85.40, Fax (1) 40.85.84.83.
Elonex (France) s.a.r.l, Paris, France

Tel 10-41 42 26 Fax 10-41 45 96
NV Elonex (Benelux) SA, Wavre (Bierges), Belgium

Tel 1-6797554 Fax 1-6791728
ERS Computers, Dublin, Eire



Orchestrated Power

Few manufacturers can match Elonex for its powerful new range of Personal Computers and build them to the quality normally associated with far more expensive brands.

Fewer still can supply you directly as wide a choice of high performance File-servers and Workstations, all fully installed and ready to run under NetWare and Unix.

Only a handful possess the in-house expertise to help you get the maximum out of connecting them together.

None offers complete solutions as flexible and cost-effective as ours.

ELONEX

**PERSONAL
COMPUTERS**

CeBIT Grows as Technology Shrinks

Just as Moore's law predicts that the number of transistors in a microprocessor will increase year by year, so German federal law seems to insist that the number of halls filled at the annual CeBIT show in Hannover, Germany, must similarly increase. With 24 halls and 630,000 visitors passing through the show's doors during its 10-day period, CeBIT has become Europe's preeminent show.

As people may have predicted, a large percentage of the new products on show at CeBIT fell within the notebook market sector. New notebooks with 486 processors and color screens were proudly paraded, while new players ventured into the world of palmtops and pen-based systems. Several peripheral manufacturers announced notebook peripherals.

The most striking piece of portable technology was what Toshiba claims is the world's first complete mobile multimedia machine. Basically, you take a T6400 PC with a color TFT (thin-film transistor) screen and then add a CD-ROM drive, a digital multimedia board that is based on Intel's DVI technology, and a pair of loudspeakers. You end up with a portable system that can show full-screen moving video. The DVI-based board uses two multimedia feature connectors provided within the T6400 architecture. Fast Electronic, a German multimedia specialist, designed a miniature DVI board around the Intel 750 processor set. Toshiba claims that, using this chip set, any DVI-based application will run without modification.

In the area of notebook peripherals, Comtech IT showed a slim ink-jet printer designed around the standard Hewlett-Packard print head. The tiny Jetwriter 2000 weighs less than 3 pounds and supports both single-sheet A4 and tractor-fed paper. Although the letter-quality print speed is a leisurely 44 cps, the eight built-in fonts and the use of standard C-size batteries makes this an attractive portable offering. The Jetwriter is available only to OEMs at present, but the US\$88-per-unit OEM price means that the street price—when the printer arrives—should be remarkably inexpensive.

The finalization of the PCMCIA 2.0 standard last September has also borne fruit. Now there are cards with larger storage capacities, as well as several PCMCIA peripheral devices, on show. Two companies, Dr. Neuhaus and Hot Line, are showing modems that fit within the tiny card format. Both companies offer 2400-bps modems with V.21, V.22, V.22bis, V.23, and 9600-bps Group 3 fax transmit and receive. The Swedish Hot Line modem additionally provides V.42bis, MNP level 5, and enough nonvolatile RAM to store 20 frequently called numbers. The days of tangled cables, fragile boxes, and dangling-line interfaces may soon be over.

—Andy Redfern

Triumph-Adler and Photonics Announce an Infrared Mobile Network

Photonics and Triumph-Adler have announced a joint technology development agreement designed to provide wireless connectivity capabilities for the Triumph-Adler line of mobile laptop and notebook computers. The companies demonstrated the first implementation at CeBIT.

The technology is based on the Pho-

tonics Infrared Transceiver, which provides wireless LAN connection for portables. The Infrared Transceiver utilizes industry-standard LAN protocols. As part of the agreement, Photonics will supply a network software driver for Novell's NetWare 386.

The infrared technology that Photonics and Triumph-Adler use is globally

NANOBYTES

Sun Microsystems has announced that, starting in June, a new subsidiary called SunExpress will be selling "customer-installable products that enhance Sun's client/server computing environment." It is basically a way of selling products directly to dealers and customers. Although details have yet to be finalized, the operation will be run from one location in Europe with a team of multilingual telecommunications sales staff. You will be able to order a product by phone, fax, or E-mail, and SunExpress's goal is to deliver its products within three days. □

Although many pundits are claiming that ISDN offers too little, too late, companies are still signing up to join ISDN projects, especially in the area of videophone technology. A more interesting announcement is Olivetti's and British Telecom's joint venture to develop a multimedia application that makes use of the ISDN link. The systems being developed will be demonstrated this summer. The basic system will offer simultaneous transmission and reception of full-motion video images, high-quality audio calls, and high-speed file transfer. Work undertaken at the Olivetti Research Labs in Cambridge, Pisa, and Milan will be included in this new development (see "Inside Pandora's Box," November 1991 BYTE, International Section). □

In a separate announcement, Olivetti has launched a multimedia upgrade kit. The kit is compatible with the MPC specification. Olivetti is selling the kit for use in any PC better than a 386SX, but the company suggests that you will require a 386DX for multimedia authoring applications. □

compatible, since infrared light is always available and isn't regulated. In addition, infrared is mostly immune to EMI (electromagnetic interference) and RFI, and it is unaffected by incandescent or fluorescent lighting.

The Photonics/Triumph-Adler infrared technology is diffuse. With diffuse infrared light, the entire room reflects the signal, eliminating the need to aim transmissions and making it difficult to block signals. This technology is similar to that being used by Infralink, a German manufacturer that developed an infrared parallel-port device for connecting laptops to printers. Even though Infralink has announced that it is working on an infrared network, company

sources suggest that it will not be shown until Fall Comdex.

Photonics was founded in 1985 to develop OEM- and end-user mobile computing products. Major investors include Alpha Partner, Apple, Cornerstone Ventures, Crosspoint Venture Partners, and Venrock Associates. The Apple connection is of extreme interest to watchers in Cupertino, California, since this technology could be of use in the upcoming PDA (Personal Digital Assistant) products. A Photonics representative, however, refused to comment on Apple, saying only that "we work for a lot of OEMs and will have more announcements this year."

—Larry Loeb

This Time, More Than Any Other Time

Chuck Peddle's work with Commodore, Victor, and Tandon is still remembered even though it is some 15 years since the Commodore Pet was launched. Currently, Peddle is heralding his new company, called THStyme (pronounced "this time") as a dealer's friend. He claims that THStyme will be the first true European-wide distributor with low prices and even better margins.

Peddle explained that the low product prices were achieved through several joint ventures. The Russian script on the back of Peddle's business card suggests

that these new alliances may not be in the Far East.

Peddle's altruistic claim that he will see dealers through the recession by offering them the best possible value for the money has a hidden agenda: He is working on a new range of computers that he claimed would be a major breakthrough in technology. The technology, currently being developed in Scotts Valley, California, is almost finished, and Peddle's goal is to have the machines ready for launch at the end of this year.

—Andy Redfern

National Semiconductor Creates All-in-One Communications Solution

Integrating voice, data transmission, and fax would benefit many people. National Semiconductor claims to have developed a chip set capable of supporting a single telephone line with voice, mixed data, and fax calls. The chip set also supports remote-access and solid-state voice-message recording.

The chip set, developed and manufactured in National Semiconductor's Israeli factory, is a matchbox-size board that requires you to add only RAM. Typically, the device would be included in a machine whose design is similar to that of a fax machine but able to treat various calls. An incoming voice call could be transferred to the handset. If no one answers, the device records and stores the message in the solid-state memory. It could also answer a data call and set up a connection with an attached personal

computer. Finally, the device could deal with a fax call by outputting the transmission to the fax printer or storing the image in the solid-state memory.

The chip set also offers a fairly open architecture. Through software encoded in ROM within the processor chip, more functions can be added. One application shown by National Semiconductor was for simple remote-message processing. For example, if you called in to work from home, the device would tell you how many voice messages and/or faxes you had. Using a Touch-Tone pad, you could select which messages to play, delete, or store. Also, by dialing in from a fax machine, you could have the faxes forwarded to you. A more exciting prospect is having this technology built into your personal or notebook computer. ■

—Andy Redfern

NANOBYTES

Ligature (Jerusalem, Israel) may claim a neural-network-based OCR package (see "Looking at Israel's Soft Side," March BYTE, International Section), but the contenders for second place are already lining up. **Mimetics** (Chatenay-Malabry, France) has combined neural-network technology with lexical and context analysis to produce what it claims are the best results yet achieved. Running under Windows, Mimetics' EasyReader should be available by the time you read this. □

The prospect of a writable CD technology for your personal computer is a step closer through Philips' announcement of the CDD 521, a desktop CD recording system. The Philips drive is capable of writing disks in the industry-standard XA (Extended Architecture), CD-I (Compact Disk-Interactive), and Photo CD formats. The unit has the added advantage of being able to record CDs at double the normal reading speed. The price is expected to be about £4000, but the exact price and availability were not disclosed. □

Going direct appears to be the industry's latest fad. Even IBM, the staunchest supporter of dealer and distributor networks, looks set to announce a direct-marketing plan across Europe. Although IBM is believed to be creating a new range of personal computers suitable for business users in small- and medium-size companies, the news has not yet been officially confirmed.

IBM will emphasize fast delivery and good technical support. It is also believed that IBM will sell under its own brand name, even though the computers will not be the same models as the ones IBM now sells through the dealer channel. IBM will also be emphasizing customer service by providing a user-friendly magazine and a wide range of peripherals and applications. ■



Dan-486c/33 May '92	Dan-486c/33 January '92	Dan-486c/33 August '92	Dan-386c/33 March '91	Dan-386c/33 October '91	Dan-386c/33 November '91	Dan-386SX/20 January '92	Dan-386SX/16 January '91	Dan-286/20 May '91	Dan-286/12 August '91	IDE Cache Controller

ENHANCED CONFIGURATION - SPECIAL OFFER SYSTEMS

We have selected the most popular configuration for every model in our range and made it available at a special discounted price.

Computer Model	Dan 486c/50s8	Dan 486c/33s8	Dan 486c/33s4	Dan 486SX/20s4	Dan 386c/40s4	Dan 386SX/25s2	Dan 286/12s
Processor:	80486DX	80486DX	80486DX	80486SX	80386DX	80386SX	80286
Processor speed:	50MHz	33MHz	33MHz	20MHz	33 or 40MHz	25MHz	12MHz
BIOS:	AMI	AMI	AMI	AMI	AMI	AMI	AMI
Shadow RAM:	YES	YES	YES	YES	YES	YES	YES
Cache Memory(max):	256KB / (256KB)	64KB / (256KB)	64KB / (256KB)	64KB / (256KB)	64KB / (256KB)	64KB / (256KB)	1MB / (4MB)
Main memory(max):	8MB / (32MB)	8MB / (32MB)	4MB / (32MB)	4MB / (32MB)	4MB / (32MB)	4MB / (32MB)	256KB max
1MB Video card:	YES	YES	YES	YES	YES	YES	14" SVGA
Colour Monitor:	14" SVGA	14" SVGA	14" SVGA	14" SVGA	14" SVGA	14" SVGA	14" SVGA
Serial / Parallel ports:	2 / 1	2 / 1	2 / 1	2 / 1	2 / 1	2 / 1	2 / 1
Keyboard:	UK 102 Key	UK 102 Key	UK 102 Key	UK 102 Key	UK 102 Key	UK 102 Key	UK 102 Key
Case:	Mini Tower	Mini Tower	Small footprint	Small footprint	Small footprint	Small footprint	Small footprint
Power Supply Unit:	200Watts	200Watts	200Watts	200Watts	200Watts	200Watts	200Watts
Floppy Disk Drive:	1.44 & 1.2MB	1.44 & 1.2MB	3.5" 1.44MB	3.5" 1.44MB	3.5" 1.44MB	3.5" 1.44MB	3.5" 1.44MB
Hard Disk Drive:	210MB / 15ms	210MB / 15ms	129MB / 16ms	129MB / 16ms	129MB / 16ms	100MB / 15ms	40MB / 28ms
Serial Mouse:	MS Compatible	MS Compatible	MS Compatible	MS Compatible	MS Compatible	MS Compatible	MS Compatible
MS DOS 5.0:	YES	YES	YES	YES	YES	YES	YES
MS Windows 3.1:	YES	YES	YES	YES	YES	YES	YES

£ 1728
£ 1513
£ 1216
£ 1075
£ 997
£ 827
£ 588

Circle 451 on Inquiry Card.

Add £ 181 for 1MB IDE Cache Controller

Delivery to most of UK for one system is £15.00. Prices exclude VAT. All systems have **LIFETIME GUARANTEE** (FIRST YEAR FULL BACK-TO-BASE PARTS & LABOUR, THEN LABOUR & TELEPHONE HOTLINE ONLY). Optional on-site maintenance (8-hour response), 14 DAY MONEY BACK GUARANTEE IF NOT SATISFIED (excludes printers). **SHOWROOM HOURS: MONDAY-FRIDAY 10am-6pm**

dan TECHNOLOGY plc

NOVELL
Authorised Dealer

TEL: 081-902 9922

UNIT 8, TOWERS BUSINESS PARK, CAREY WAY (cnr Fourth Way & South Way), WEMBLEY, MIDDX HA9 0LQ. FAX: 081-902 3300

DAN TECHNOLOGY Systems prices and specifications are subject to change without notice. All trademarks acknowledged.

COMPUCLASSICS

1-818-347-2444
OR FAX YOUR ORDER
1-818-347-9977
Indicates Windows Compatible Products

YOUR INTERNATIONAL SOURCE FOR SOFTWARE

- ★ **Over 7 Years Experience**
Providing Our Customers With
The Best In US Software
- ★ **5 Years Servicing The**
International Market
- ★ **Volume Discounts**

- ★ **Net Terms For Large**
Corporations
- ★ **Express Delivery**
- ★ **No Minimum Orders**
- ★ **A Huge Inventory With All The**
Latest Versions

CAD	
Autosketch 3.0	145
Design Cad 2D 5.0	179
Design Cad 3D 4.0	265
Generic Cadd 6.0	299
Draxid Cad for Windows 2.0	439

PC U.S.A. 2.0	29
Where In The World Is Carmen	
San Diego?	32
World Atlas	55
Professor Windows	29

C Tools Plus	119
Codebase ++	219
K Edit 4.0	105
Norton Editor 2.0	68
Novell Btrieve For DOS 5.1	429
Object Professional 1.1	125
Object Professional For C++	165
Power Tools Plus 5.1	119
SF/PC 2.1	195
Sourcer w/Bios	155
Turbo C ++ 3.0	69
Turbo C Tools	119
Turbo Pascal 6.0	99
Turbo Pascal Professional 6.0	199
Turbo Professional 5.11	89
Actor 4.0	159
Actor Professional 4.0	319
Borland C ++ 3.0	329
Borland C ++ W/Application Framework 3.0	499
Knowledge Pro For Windows 2.0	129
Novell Btrieve For Windows 5.1	429
Object Graphics For C ++	125
Objectvision 2.0	105
Realizer	305
Smalltalk Windows	319
Toolbook 1.5	295
Turbo C ++ For Windows 3.0	105
Turbo Pascal for Windows 1.0	125
Win ++	149
Windows Maker Prof	899
Zortech C++ Competitive Upgrade 195	
Zortech C++ Win-DOS/OS/2 3.0	485

PERSONAL INFORMATION	
Automap Europe	79
Calendar Creator Plus 4.0	59
Infoselect 2.0	95
Calendar Maker Windows 1.1	49
Orig Plus Adv. W/AdobeTypeMan	129
Pocket 4.0	250

COMMUNICATIONS	
CC: Mail MS DOS Platform Pack	145
Carbon Copy Plus 6.0	119
Crosstalk XVI 3.8	122
Laplink Pro 4.0	109
Mirror III 2.2	85
PC Anywhere (Host & Remote) 4.5	119
ProComm Plus 2.0	75
Reflection 4 Plus 4.1	299
Smartterm 340 2.0	215
CC:Mail Windows Platform Pack	365
Carbon Copy For Windows	119
Close Up Customer/Support 4.0	129
Co Session (2 User)	99
Crosstalk For Windows 1.2	122
DeVinci Win EMail (8 User) 1.7	335
Dynamac Asynch for Windows	159
Fraggrabber W/Norton Desktop	105
Faxit For Windows 2.15	89
Winfax Pro	79

ENTERTAINMENT	
Airline Transport Pilot	39
Chessmaster 3000	32
F 19 Stealth Fighter	42
F-15 Strike Eagle II	35
Falcon 3.0	49
Gunship 2000 (VGA)	42
Jetfighter II	32
King's Quest V - (EGA)	45
King's Quest V - (VGA)	42
Leisure Suit Larry V VGA	36
Links: The Challenge of Golf	42
Simant	42
Sinicity	32
Simearth	42
Space Quest IV	32
Test Drive III: The Passion	46
Western Europe Scenery Disk	24
Wing Commander II	49
Casino Pack For Windows	39
Chessmaster 3000 For Windows	39
Simearth For Windows	42

PROJECT MANAGEMENT	
Project Scheduler V	429
Timeline For Windows	479

SPREADSHEETS	
Baler 5.1	109
Baler XE	549
Impress 2.1	79
Lotus 1-2-3 3.1+	409
Lotus 1-2-3 2.3	339
Lotus 1-2-3 Version Upgrade 3.1+	109
Quattro Pro 4.0	309
Quattro Pro Competitive Upgrade 4.0	99
Lotus 1-2-3 Windows 1.0	412
Lotus 1-2-3 Win Comp Upgrade	119
Lotus Double Up Upgrade	205

DATABASES	
Blinker 2.0	259
Clipper 5.01	519
Codebase 4.5	249
Dbase IV 1.5	529
Dbase IV 3.5	539
Foxpro LAN 6 Pack 2.0	479
Foxpro Single User 2.0	189
Funky Lib 1.5	189
Net Lib For Clipper	245
Paradox 3.5	499
Q & A 4.0	269
R & R Relational Report Writer 4.0	175
dGE 4.1	229
DB Best/Windows 1.7	345
Superbase 4 for Windows 1.30	489

FORMS/FLOWCHARTING	
Flowcharting 3	139
Formtool Gold 3.0	59
Interactive Eysflow 7.0	165
Org Plus Advanced 6.0	65
Per: Form Designer & Filler 2.1	95
ABC Flowcharter	185
Instant Orcharting!	125
Per: Form Pro	185

MUSIC/MULTIMEDIA	
ATI Stereo F/X	139
Ad Lib Music Synthesizer Card	79
Soundblaster	119
Soundblaster Professional	199

STATISTICS/SCIENCE	
CSS: Statistica	619
Chi Writer Deluxe 4.0	495
Derive 2.1	135
Grapher	145
Mathcad For DOS 2.5	919
Mathematica 386/387 (International Version) 2.0	185
SPSS PC Base Module 4.0	185
SPSS PC Plus Advanced 4.0	275
Sigma Plot 5.0	455
Statgraphics 5.0	629
Surfer	365
System 5.0	739
Math Type For Windows 3.0	169
Mathcad For Windows 3.1	315
Mathematica Windows (International Version) 2.0	1045

DESKTOP PUBLISHING	
Morefonts 3.01	75
Publisher's Powerpak /WP/Ward	49
The New Print Shop PC w/Holiday Fun 37	
Ultrascrip PC 3.0	112
Ultrascrip PC Plus 3.0	245
Ventura Publisher DOS/GEM 3.0	529
Adobe Type Align for Windows	65
Adobe Type Manager 2.0	65
Adobe Type Manager Plus Pack	125
Alltype Windows	49
Bitstream Facelit for Windows	65
Omnipage Professional 2.0	655
PageMaker 4.0	499
Publisher's Paintbrush 2.0	299
Publisher's Powerpak Windows	49
Recognita OCR - Full Language	479
Ventura Publisher Windows 4.0	529
Wordscan Plus	689

GRAPHICS	
Deluxe Paint II Enhanced	85
Freelance Competitive Upgrade 4.0	109
Harvard Graphics 3.0	419
Hilook 2.10	129
PC Paintbrush IV Plus 1.01	119
Pizzazz Plus 3.0	85
Print A Plot 2.0	189
Adobe Illustrator Windows 4.0	389
Corel Draw Windows 2.0	369
Freelance For Windows	359
Freelance Win Comp. Upgrade	109
Harvard Draw Competitive Upgrade 99	
Harvard Graphics Windows 1.0	359
Harvard Graphics Comp Upgr 1.0	125
Image-In Color Professional	569
Image-In Color PropMstr Fullpack	709
Micrografix Charisma 2.1	335
Micrografix Designer	399
w/ Adobe Type Manager 3.1	399
Micrografix Windows Draw 3.0	99
Picture Publisher 3.0	549
Stanford Graphics	415
Superprint For Windows (HP) 2.0	1115
Tempa Pro	315

NETWORKING	
3COM Etherlink II	199
3COM Etherlink Plus	629
Intel Ether Express 16	135
Intel Net Satisfaction SW For Novell	659
Intel Netport (Thick or Thin Wire)	419
Lan Assist Plus 3.1	299
Lanspace 2.0	359
Map Assist 3.0	359
NE 1000 Without Cable	139
NE 2000 Without Cable	165
Novell Network 2.2 (10 Users) 2.2	1225
Novell Network 386 (20 User) 3.11	2175
Novell Network 386 (5 User) 3.11	759
PS Print 3.4	265
Printer/Q Assist 4.2	259
SMC Plus Elite (16 Bit)	165
SMC Plus Elite (8 Bit)	129
Saber File Manager 2.0	239
Sitelock 3.2	329
Xircom Pkt Ethernet II BNC	359

UTILITIES	
1 Dir Plus 3.5	49
386 Max 6.0	65
Above Disk Draw	62
Autosmenu 4.7	39
Central Point Anti-Virus	85
Check It 3.0	89
Copy II PC 6.0	35
Copywrite	65
Disk Manager (DOS) 5.0	39
Dr Solomon's Anti-Virus Toolkit	67
Fastback Plus 3.04	122
Menu Works Advanced	529
Netroom (1 user) 2.2	62
Netroom (4 User) 2.2	115
Norton Antivirus For Win/DOS 2.0	89
Norton Commander 3.0	99
Norton Utilities 6.01	115
PC Kwik Powerpak 2.1	75
PC Tools Deluxe 7.1	119
PKZip/PKUnzip	49
Print Q 5.0	85
Printcache 3.0	95
Q DOS 3	45

QEMM 386 6.0	62	Courier HST Dual Standard GX1	909
GRAM w/Manifest 2.0	49	Hayes Pocket Modem 2400	
Spirit II 2.0	64	W/Smartcom EZ	129
Stacker Data Compres (Software Only)	95	Intel 14.4 EX Modem	579
Stacker Data Comp (w/ 16 bit Bnd)	189	Intel Satisfaction 9600 Classic	385
System Sleuth Pro 4.0	199	Quicket Int. 2400 Modem	
Untouchable Virus Protection	99	w/MNP 5 & v.42 BIS	119
Virex PC 2.0	62	Quicket Int. 9600 Send/Receive Fax	
XTree Gold 2.5	99	w/2400 Modem	125
Above Utilities for Windows	55	Teletip QBlazer Modem 9600	
Afterdark for Windows 2.0	32	V.32/V.42BIS	529
Backtools 3.0	45	Worldport 2400 Modem w/MNPS	
HDC Fileapps	75	V42bis	235
HDC Power Launcher	59	Worldport 2496 Fax/Modem	272
HDC Windows Express 3.0	59	Worldport 9600 Modem	435
Icon Do It	22	Zoom 2400 Internal Modem	
Norton Antivirus Win/DOS 2.0	89	w/Procomm	69
Norton Desktop For Windows 2.0	99	Zoom 9624 Send/Receive Fax	
Virus Secure For Windows	59	Modem External	125
Wideangle For Windows 2.0	82	Zoom 9624 Send/Receive Fax	
Winswath 2.0	99	Modem Internal	115
Wingspeed	49	Zoom Int. S/R Fax/Modem	
W/Wintax	149	Intel Satisfaction Board Scanner	229
W/Writer's Toolkit	85	Scanman 256	285
Fonts On The Fly 2.0	95	Colorado Jumbo Int. Tape Dr 250MB	279
Glyphix Intro Fonts For Wordperfect	69	Colorado Jumbo Int Tape Dr 120MB	215
Grammatik V 2.0	59	Plus Hardcard IXL 105MB	479
Rightwriter 5.0	75	Plus Hardcard IXL 50MB	325
Software Bridge 5.1	59	ATI Graphics Ultra + 1MB	629
ATI Graphics Ultra + 512K	489	ATI Graphics Ultra + 1MB	489
AMI Professional 2.0	299	Hercules Graphic Station Card 1MB	559
Wordperfect For Windows	289	Orchid Fahrenheit 1280 W/1MB	345
Video Seven VGA 1024i 512K	162	Logitech Mouseman Cordless	89
Logitech Trackman Portable	102	Pacific 1-2-4 Memory Board w/2MB	245
Pacific 1-2-4 Memory Board w/2MB for HP HP & III	142	Pacific Fontbank 75MB	225
Pacific Page	365	Pacific Page Personal Edition	299
Super Cartridge 3 Professional	279	Canon Bubblejet BJ-300	495
Diconix 1805I Ink Jet Printer (Parallel)	319	Diconix 1805I Ink Jet Printer (Serial)	339
Diconix 220V European Adapter	25		

YOU CAN DEPEND ON US TO BE YOUR INTERNATIONAL SOURCE FOR SOFTWARE

PLEASE SPECIFY DISK SIZE WHEN ORDERING

WE'RE THE BEST CHOICE FOR ALL YOUR SOFTWARE NEEDS! IN GERMANY FAX TOLL-FREE 0130-816520

IN FRANCE FAX TOLL-FREE 0590-6757

IN SPAIN FAX TOLL FREE 0509-0685



We accept Mastercard, Visa, Eurocard, American Express, JCB and Bank Transfers. We offer credit terms to large international corporations. We also accept payment by check if drawn on a U.S. bank in U. S. dollars. Please call or fax before submitting payment to obtain shipping costs. We ship by DHL, TNT, US Mail or freight forwarder for large orders. 2% surcharge on American Express and JCB.

We separate invoices into manuals, software and diskettes to minimize import duties. Prices are subject to change without notice. All versions are latest versions. We replace all defective items as soon as possible. Please call or fax our customer service department for specific instructions before returning any product.

Because of the time difference, it is best to correspond by fax. If you need to phone us, please call between the hours of 7 a.m. and 6 p.m. Pacific Standard time. (We are 9 hours behind most of Europe). **CALL US FOR ANY ITEMS NOT LISTED.**

P.O. Box 10598, Canoga Park, CA 91309 • Showroom: 7959 Deering Ave., Canoga Park, California 91304.

Circle 422 on Inquiry Card.

A Fist Full of Fonts

GRAHAM JONES

Everyone likes good-looking fonts, but how do you assess the value you get for your money from one manufacturer to the next?

Typefaces are fast becoming one of the most important considerations for computer users. Gone are the days when all you needed to think about was how smooth the dot-matrix characters appeared and whether you needed a new ribbon. The ubiquitous presence of laser printers means that virtually every serious computer user can print quality documents.

The original laser printers produced by Apple had just four basic typefaces. Now, most laser printers have 35 fonts in them, and QMS printers have 45 fonts in their standard array of type styles.

But even this range is not enough. Because of the increase in desktop publishing and the need to appear original on paper, many people are interested in additional typefaces that are not provided with a laser printer. Supplying fonts is big business, with many successful companies existing solely on selling fonts to computer users.

Everyone Wants Fonts

Until about five years ago, fonts were being supplied to just a small number of key customers. The market was small, with only typesetting companies buying fonts in any great quantity. But with the appearance of PostScript and the ability to download any font to any laser printer, the market for disks of typefaces has

grown exponentially. However, this dramatic rise in demand for fonts is causing problems. The expense, for example, of buying dozens of different fonts is off-putting. And for those with heavy font usage, such as typesetting bureaus, the thought of having thousands of floppy disks sitting on a shelf is mildly alarming—the disks for the entire Adobe Type Library would take up nearly 10 meters of shelf space.

The answer to this problem is CD-ROMs. A number of entire type libraries are now available on CDs. This avoids the problem of storing endless floppy disks and solves the cost issue, as well.

The main type suppliers lock the fonts that they supply on their CDs. This means you can buy an entire library for little more than the cost of the CD itself. When you want to use a particular font, you simply fax the manufacturer the name of the font you want to use. The supplier calls you with a password code and charges you on your credit card. You then enter the password, and the font you want to use is unlocked.

The advantage of this system is that the costs of font supply can be kept to a minimum. If you buy fonts on a floppy disk, you normally have to buy the entire family that makes up a particular typeface. For instance, even if you wanted to use only Helvetica Bold Condensed, you would be forced to buy seven other variations of Helvetica Condensed, as the entire family consists of eight fonts that are all supplied on one floppy disk. With the CD system, you pay for only the fonts you want to unlock. So, if you want only Helvetica Bold Condensed, that's all you pay for. The other variations of Helvetica Condensed would remain locked, because each font has a different password.

There are two main type libraries currently available on CD-ROM. The Adobe Type Library is available on a CD called Type On Call. The Monotype Typeface Library from Monotype Typography is also available on CD-ROM and can be accessed using the company's FoneFonts service (see the screen).

A third player, GBM Group, has entered the CD-ROM market, but it doesn't use password protection for the 999 fonts on its disc. This CD, called The Serials Typecollection, has all fonts in an unlocked state. You simply buy the entire collection. You also can buy the entire collections from Adobe and Monotype in an unlocked state, but the cost is up to

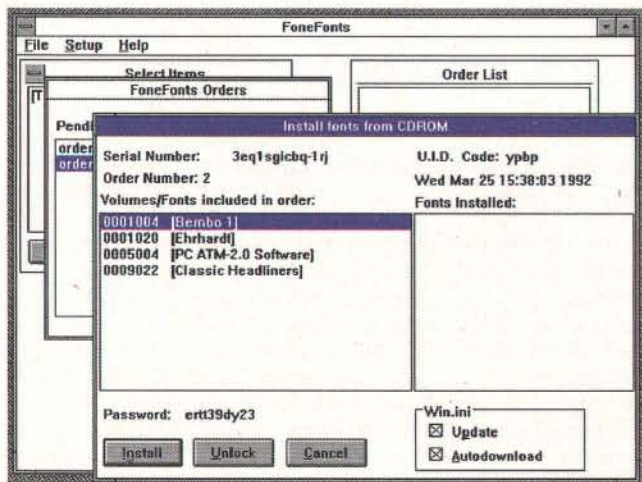

The FoneFonts software lets you select the fonts you require from the CD and then automatically generates an invoice that you send to any Monotype Typeface Library dealer. The dealer sends you a unique key code for each font, which you enter to unlock the CD.

COMPUTER QUICK

Add-In/Add-On

ATI Wonder Plus XL 512	215
8514 Ultra & VGA 1MB	550
Stereo FX	135
Digichannel PC 8-port	375
Everex Viewpoint TC	525
Fahrenheit 1280 - 1MB	340
Hercules Graphics Station	535
Graphics Station 3MB	685
Logitech Mouseman Serial	55
Scamman 256	275
Mouse with Windows 3.0	75
MS Mouse with Windows 3.0	149
Prodesigner II - S 1MB	235
Soundblaster Pro - iNew!	210
Volante AT1000	720

16,000 Items
Price Diskette
Shipped with order

LapTops

AST 386SX20/40/60	CALL
Everex	CALL
Sharp	CALL
Toshiba	CALL
Texas Instruments	
TM2000 20/40	1035/1285
TM3000	New low price

Modem/FAX

Modems for all portables	LOW
FAX 9600 & Modem 2400	85
Faxit for Windows	129
Hayes 2400B Internal	255
Hayes Ultra 96	849
Intel Satisfaction	395
Pocket FAX96/Modem24	150
USR V.32/V.42Int/Ext	440/500
USR HST/V.32 Dual Ext Std	865

Networking

3COM Etherlink 2	LOW
AST 5251-11 Enh Plus	515
DLink Pocket Ethernet	265
Everex Ethernet 8/16	87/135
Hayes Ethermate 8	96
IBM 3270 Connection	375
IBM 5250 AT/MC	510
IBM Token Ring 16/4	630
Intel Ethernet 16	130
Intel Netport	495
IRMA-3	435
LANFAX for Windows	CALL
LanTastic 10MB Starter	485
LanTastic AI Node	60
Mylex EISA Ethernet	309
NE-1000/compatible	135/85
NE-2000/compatible	161/126
NE-2100	155
NE3200 EISA	665
Netware Lite	70
Novell Network	CALL
Shiva Netmodem	1665
WD Ether Elite Compat	100

WD Ethercard Elite	125
WD Ethercard Elite 16	160

Operating System

Desqview 2.2/386	75/130
MS DOS 3.3 or 4.01/5.0	45/55
IBM OS/2 Standard 1.3	128
IBM OS/2 Extended 1.3	500
NewWave	110
XENIX/UNIX	CALL
Windows 3.0	65
Windows 3.0 + Mouse	75

Programming

Brief Intl Version	140
Briefor C++	50
Knowledge Pro Windows	360
MS Basic Dev 7.0	325
MS C Compiler	319
MS Fortran	289
MS Quick C w/Assembler	139
Smalltalk V/PM	319
Turbo C++	315
Turbo PASCAL Win Upgrd	115

Spreadsheet & WP

AMI Pro Upgrade	105
Displaywrite V	249
Excel Windows Upgrade	130
Lotus 1-2-3 for Windows	425
Word for Windows Upgrade	130
Word Perfect Windows Upgr.	90

Utilities

Check It	85
Norton Utilities 6.0	110
PC Tools Deluxe 7.1	107
QRAM/QEMM 386	40/59

We Offer:

- Quantity Discounts
- Dealer Discounts

Backup

Colorado 250MB	309
HP DAT Tape Backup	
1.3/2/8GB 1400/1560/1950	
Wangtek 5150S Int/Ext 640/750	
Software for DOS/UNIX/LAN	

CAD & Graphics

Autocad Rel 11	CALL
Calcomp 33120	415
Corel Draw Ver 2	380
Design CAD 2D/3D	175/199
Drafix CAD for Windows	430
Freelance Plus	335
Nunomics GraphicMaster	CALL
Summasketch	CALL
VinylCAD	600
Xerox GS+ Scanner AT	1360

Chips & Memory

All Upgrades - ALR, AST, Apple, Compaq, DEC, Epson, HP, IBM, Silicon Gr, Sun, Toshiba

80287	LOW
80387SX-16/20	109/120
80387DX - All speeds	175
SIMM 1MB/4MB 70ns	44/160
ALL CHIPS AND SIMMS	CALL
HP Laser 2MB/4MB	140/230

Communications

Carbon Copy Host&Term	115
Close-Up Customer&Support	135
Smarterm 320	125

Database

Clarion Pro Developer	450
Clipper 5.01	495
Dataease 4.5	525
Dbase IV	489
Dbase IV Developers Edition	839
Foxpro Single/LAN	469/665
Oracle Professional V6	1100
Paradox 3.5 Upgrade	175
Rbase 3.1	465
Superbase 4 for Windows	460

Desktop Publishing

Adobe Type Man Windows	59
Pagemaker	519
PerFormPro Design/Fill	298
Quark Express	580
Ventura Publisher 4.0	525

Disk Drives

Seagate 351AX	200
Conner 60MB	200
Maxtor 60MB	200
Plus Hardcard IXL 105 9ms	480
Maxtor 120MB 15ms	360
Conner 120MB 15ms	360
Quantum 123MB 15ms	360
Maxtor 213MB 15ms	580
Quantum 245MB 15ms	580
Maxtor LXT340 14ms	960
Conner 543MB 12ms	1165
Maxtor 675MB 16ms	1400
HP 661MB 16ms	1600
Maxtor 1.2GB SCSI	1955
CD-ROM - Optical - WORM	CALL

Controllers

Adaptec 1542B	260
DPT Smartcache EISA/SCSI	575
IDE caching with 4.5MB	550
Mylex EISA/SCSI cache	660
Ultrastor EISA/SCSI cache	450

PHONE: (415) 861-8330
Español (415) 861-8376
FAX: (415) 861-8380

International orders our specialty • Low freight rates - No handling charge
Prices are for cash prepayment • VISA/MC/AMEX accepted • Products may be USA versions • No returns on opened software • Prices are FOB USA and subject to change • 15% restocking charge for non-defective returns

Computer Quick, 165 - 8th Street, No. 309
San Francisco, CA 94103, USA

Monotype Bembo
& EXPERT SET 236
& real cursive italic
& ligatures fiffiffi

Serial Bamberg
with no expert
set or real italic
or ligatures fi fl

Figure 1: The top font is Bembo from the Monotype Typeface Library on CD-ROM, and Bamberg is its compatible from The Serials Typecollection. Although the basic fonts look similar, The Serials Typecollection's Bamberg lacks a real italic face and the ligatures. Also, although The Serials Typecollection includes many kerning pairs, some of the standard pairs are not particularly good (see the Bamberg fl pair).

£18,000, so it's not something most users will wish to do. The Serials Typecollection costs just £666, so those who use a large number of type styles might find it more attractive.

The Serials Typecollection
At first sight, the price of The Serials Typecollection looks attractive. You get 999 fonts for £666, which works out to be just 66 pence per font. Compared with the lowest fee of £12 per font that you'd be charged for the Monotype collection, this seems like an amazing deal.

And it would be a superb deal—if the fonts you receive with The Serials Typecollection were well-known, established fonts. In fact, the collection of fonts were all designed by one typographer, Florenz Brendel, who, according to the package, is an internationally renowned designer. While this may well be true, the fonts on the CD are not ones many designers have heard about. Some of the designs are familiar because they appear to be virtual copies of traditional, established type designs from larger type houses.

Some of The Serials Typecollection are, therefore, molded after existing typefaces. If all you want is type for your own laser printer, that's not a bad thing, and at

66 pence per font, it is also not to be sneezed at. However, if you are a desktop publisher who will be using a typesetting bureau for your artwork production, you will need to make sure that the bureau has the same collection you have. If you have The Serials Typecollection, the bureau must have The Serials Typecollection as well.

The need for total compatibility is not the only problem for desktop publishers. The Serials Typecollection lacks proper italic faces (see figure 1). To produce italics from many faces in The Serials Typecollection, your computer will simply slope the roman type. That is not italicization. Proper italics are different designs, because the structure of the type must be changed to make it more readable. Proper italics are more easily and quickly read than ordinary slanted type. So, desktop publishers keen to create professional-quality publications will find The Serials Typecollection seriously limiting because of its lack of italics.

Other typographical problems with this collection are cause for concern. For instance, the kerning appears to be overzealous. Kerning involves adjustments in the space between characters to preserve the even appearance of words. Without

THE ANSWER TO TERMINAL INSECURITY



PC-GUARD

Protecting your PC from accidental or malicious loss of data or programs and from virus infection.

- ACCESS CONTROL
- BOOT PROTECTION
- RESOURCE PROTECTION
- DYNAMIC TIME-OUT
- VIRUS PROTECTION
- ANTI-HACKING
- AUDIT TRAIL
- REPORTING
- ADMINISTRATION
- LAN SECURITY



Best Buy

"The best general purpose security solution . . . PC-Guard"

PC:USER Best Buy

"Overall, PC-Guard has been well thought out and offers a good selection of security tools"



Highest Score

"Transparency and rich control of resources make this the most complete solution tested"



Editors Choice*

"For basic security and resource control for PCs, our choice is PC/DACS*" (PC-Guard)

In excess of 300,000 copies installed world-wide - *in the USA as PC/DACS, in Sweden as PC-BoKS. Available in English, French, German, Italian and Swedish.

AUSTRALASIA Airtech Computer Security Tel: 03 802 1912 Fax: 03 802 1912
BELGIUM Gecotec SA Tel: 02 720 50 01 Fax: 02 721 17 94
DENMARK BFC Data Tel: 97 224 500 Fax: 97 210 405
FINLAND Unicom Consulting OY Tel: 070 018 750 Fax: 070 046 2290
FRANCE CSIL SA Tel: 01 47 89 23 37 Fax: 01 46 91 02 18
GERMANY CSS Gmbh Tel: (02 01) 7498-60 Fax: (02 01) 7486-44
ITALY Teleproject Sistemi SRL Tel: 02 66 981 094 Fax: 02 67 007 05
NETHERLANDS Alcatel Nederlands BV Tel: 070 32 63 33 Fax: 070 32 12 066
SLOVENIA Sophos Tel: 068 22 975 Fax: 068 22 975
SWEDEN Dynasoft AB Tel: 0872 685 60 Fax: 0818 1145
SWITZERLAND Tercom SA Tel: 037-26 63 33 Fax: 037-266 400
UNITED KINGDOM IDS Tel: 071 631 0548 Fax: 071 580 1466
UNITED STATES Pyramid Development Corp. Tel: (203) 257 4223 Fax: (203) 257 4245

Airtech

COMPUTER SECURITY

COMPUTER AND COMMUNICATIONS
SECURITY WORLDWIDE

AIRTECH COMPUTER SECURITY
MEADOW VIEW HOUSE
CRENDON INDUSTRIAL ESTATE
LONG CRENDON, AYLESBURY
BUCKINGHAMSHIRE HP18 9EQ
TEL: +44 (0) 844 201800 FAX: +44 (0) 844 208550

Circle 466 on Inquiry Card.



Figure 2: (Top) A close-up of a Monotype Typeface Library Bembo character in 720-point size; (bottom) a similar character from The Serials Typecollection's Bamberg font. The arrows show the areas of poor digitizing, especially noticeable in the lump on the top of the character.

kerning, type looks ugly, as unnecessary gaps appear within words. Samples of type printed from The Serials Typecollection appeared to have too much kerning, compared with fonts from other suppliers.

The Serials Typecollection comes with 1200 *kerned pairs*, or pairs of characters whose space has been adjusted to make them look better on the printed page. The number of kerned pairs is touted as being an important factor in the quality of The Serials Typecollection. In fact, the Monotype Typeface Library has more kerned pairs, with 1500 for many typefaces. Another point of concern is the quality of the digitizing used to create the fonts. Some of the curved and straight

lines do not connect well (see figure 2).

Ikarus digitizing software has a neat facility for extrapolating, interpolating, and intrapolating a font once it's entered. This allows you to create different weights of the same font very easily. But although a wide range of weights can be useful, it is hard to imagine anyone using more than three or four weights. Some of The Serials Typecollection fonts use seven or eight weights. They are probably not very useful, but providing lots of different weights is an inexpensive way to create 999 fonts.

One final problem with The Serials Typecollection is that you are not given any idea what each typeface looks like. If

COMPUTEX TAIPEI '92
JUNE 5-9
BOOTH NO. A209, A211

TP SUPERSLIM

386SX / 486SX / 486DX
MODEL 5000



CPU : 386SX-20/25/33MHz
486SX-20/25MHz
486DX-33MHz

MEMORY :

1MB EXPANDABLE TO 16MB

ON BOARD INTERFACE :

IDE/FD CONTROLLER, 2S/1P
DISPLAY : VGA BUILT-IN
RES. 1280 x 1024 IN 16 COLORS
SUPPORT VESA MODE,
64K HIGH COLORS(OPTION)

STORAGE DEVICE :

1 x 3.5"HDD & 1 x 1.44MB FDD

EXPANSION SLOTS :

TWO INDUSTRIAL STANDARD
16-BIT SLOTS

DIMENSION : W x D x H -

28CMx28CMx5CM(11"x11"x2")



TECHPOWER CO., LTD.

20TH FL., NO. 204 SEC. 5

MINGSHENG E. RD.

TAIPEI, TAIWAN, R.O.C.

TEL: (02)7531930

FAX: 886-2-7531940



ROBERT
STINNEY

BEYOND TURBO

ANNOUNCING **PASCAL⁺**TM

A High Performance Option For Turbo Pascal Users

We agree that Borland Turbo Pascal® is a great street machine. But when your applications demand the ultimate in performance, the **Stony Brook Pascal⁺** optimizing compiler has the extra power you need — and an unbeatable list of standard features.

DON'T CHANGE A LINE OF YOUR CODE

It couldn't be easier to trade up to Pascal⁺. We're 100% language-compatible with Turbo Pascal V6. **You don't change your Turbo Pascal programs at all.** Just compile with Pascal⁺ and get:

Execution speeds up to 100% faster
Code size up to 30% smaller

You get fully optimized code with **NO** difference in your program's operation!

ELIMINATE ROADBLOCKS

Pascal⁺ comes fully equipped to handle ANY programming problem you encounter. Unlike Turbo Pascal, we produce standard Microsoft® objects, support all memory models, and give you complete control over procedure-calling and parameter passing conventions.

INSTANTLY LINK TO OTHER LANGUAGES

With Pascal⁺ it's easy to interface with code written in any other language. This means, for instance, that you can have immediate access to millions of lines of commercial library code written by and for C programmers.

Turbo Pascal and Turbo C are registered trademarks of Borland International, Inc. Microsoft and Windows are registered trademarks of the Microsoft Corporation. Stony Brook Software and Pascal⁺ are trademarks of Gogesch Micro Systems, Inc.

AND WE DO WINDOWS!

Stony Brook Pascal⁺ comes with full support for Microsoft Windows 3.0. We provide the interface units, and you use the windows API exactly as you would with Microsoft C.

In fact, anything you can do with Microsoft® C or TurboC®, you can do with Stony Brook Pascal⁺!

So get on the track with Stony Brook Pascal⁺. You'll qualify for races you never could enter before.

CALL NOW OR WRITE FOR INFORMATION
800/624-7487 • 805/496-7429 Fax • 805/496-5837 Outside U.S.

Stony Brook
SOFTWARE

187 E. Wilbur Rd., Suite 4, Thousand Oaks, CA 91360
Makers of Stony Brook Professional Modula-2 and QuickMod

Buy directly from us and pay only:

\$295 plus shipping (and tax if applicable),
U.S., Canada, Mexico

\$375 includes shipping,
outside U.S., Canada, Mexico

386 SL NOTE BOOK

TP SUPERLITE



ADVANTAGES:

TP SUPERLITE 386SL
4.8 lbs
WITH HD, FD &
BATTERY PACK



TOSHIBA T3300L
5.9 lbs
AST EXEC 386SX/25
7 lbs

TP SUPERLITE 386
10.8"Wx8.5"Dx1.8"H
(27.5X21.5X4.5 cm)



ALR VIP 386SX/20
11.75"Wx8.5"Dx2.25"H
DELL 325NC
11"Wx8.5"Dx2.3"H

TP SUPERLITE 386SL
IC CARD, FD, FEET
ARE ALL BUILT-IN



TOSHIBA NO IC CARD
SHARP NO EXT. FD
APPLE POWER PC HAS FEET

SPECIFICATION:

CPU: 386SL-20/25MHz
CO-PROCESSOR: 387SX (OPTION)
MEMORY: 2MB EXPANDABLE UP TO 10MB
I/O PORTS:

VGA PORTS FOR EXTERNAL DISPLAY
1 SERIAL, 1 PARALLEL
P/S 2 MOUSE PORT

STORAGE DEVICE:

1x2.5" IDE HD 40/80/80/120MB
1x3.5" FD 1.44MB

IC CARD SLOT:

68 PIN JEIDA VER 4.0
PCMCIA RELEASE 2.0 STANDARD

POWER:

WITH POWER MANAGEMENT & FAST CHARGE
NI-CAD RECHARGEABLE BATTERY

DIMENSION:

WxDxH 275x215x45mm (10.8"x8.5"x1.8")

WEIGHT:

4.8 lbs FD, HD, AND BATTERY INCLUDED

See us at:



COMPUTEX '92

June 5-9
Taipei, Taiwan
Booth No. A209, A211

TP TECHPOWER CO., LTD.

20th Fl., No. 204, Sec. 5, Mingsheng E. Rd.,
Taipei, Taiwan, R.O.C.

Tel: (02) 753-1930

Fax: 886-2-7531940/7153105

All brand names are registered trademark of their respective owner.

NEWS

INTERNATIONAL FIRST IMPRESSIONS

Choosing the Right Font

Not everyone needs a huge collection of typefaces, but you at least want appropriate fonts for the kind of publications you are producing. Since many computer users are not professional typographers and designers, selecting the right font for the job is often a difficult task. Now, in addition to its Monotype Typeface Library on CD-ROM, Monotype Typography offers font collections geared to specific uses.

The prepackaged font collections, called Monotype Desktop Solutions, are currently available for three main types of publications: reports and presentations, forms and catalogs, and newsletters and booklets. The Desktop Solutions are available in PostScript format for PCs and Macs. The packages will also be available in TrueType for the Mac and Windows. Each package contains two complete font families and four booklets.

Two of the booklets are dedicated, respectively, to the two font families. Each provides information on the font with examples of its use.

The third booklet, *Publishing Guide and Glossary*, is a basic introduction to the practicalities of publishing. It covers the planning of publications, writing for them, the reproduction of illustrations, and production methods. The coverage is brief but to the point. If you have any publishing knowledge at all, however, this booklet is largely useless. The glossary is useful for beginners, but a proper publishing dictionary would be more helpful.

The fourth booklet—a guide to designing publications—is different for each of the three Desktop Solutions and

provides a guide to designing the kind of documents for which each font collection is intended. The advice in the booklet is clear but brief. For anyone who is serious about publishing, this booklet should be used as an introductory overview and not as a replacement for a textbook on design. Also, anyone who knows anything about design will find this booklet of little practical use. It is all basic information—very useful, but only for real beginners.

The booklets are something of a gimmick, and even though they are well written and professional, you should not use them as replacements for full design books. However, they are an excellent introduction for novices who desire a package of fonts geared specifically to the publications they are trying to produce.

The fonts that you get with the Desktop Solutions are established fonts, but they are not the ones that usually come with laser printers. The reports and presentations package includes News Gothic and Photina; the forms and catalogs package includes Arial and Amasis; and the newsletters and booklets package has Plantin and Abadi Condensed. This third package also includes the Plantin Expert Set for high-quality reproduction.

At £129 per package, these collections may be attractive to professional designers and publishers as well as beginners. This price is about half what it would cost to buy the fonts separately. So even though professionals may throw away the booklets in Desktop Solutions, the fonts will have been bought at a knock-down price. This alone makes them worth buying.

you want to see samples of each typeface, you must purchase a book that costs £29.

The Monotype Typeface Library on CD-ROM

Monotype's CD provides a very different picture from the one presented by The Serials Typecollection. I had some initial difficulties using the disc, chiefly be-

cause it was a prototype version of a CD that can be used with either a PC or a Mac. I was assured by the company that the problems I encountered won't happen on production CDs. I also hope that the company has rearranged the material on the CD. It was hopelessly disorganized on the disc I reviewed, and finding my way around the items was time-consuming



It looks like another cat and mouse game, right? But this time your mouse is safe: the new cat is Canon's ION, the revolutionary still video camera for the IBM AT or compatible computers. Having an ION attached to your PC is like having a full-colour 3D scanner which fits in your coat pocket. The ION-PC 260 Kit gives you all you need to capture full-colour still video pictures on floppy and transfer them to your computer.

ION: The Eye of your Computer

A camera, digitizer board, image retrieval software and cables are all included. The software offers a choice between 24 bit colour and 8 bit monochrome acquisition, and provides a number of other image modification functions including zoom and rotate. The ION-PC 260 Kit lets you select a variety of PC file formats for a wide range of applications:

• Desktop publishing - - newsletters, catalogues, manuals
 • Multi media - - presentations, point-of-sale, training
 • Graphic Design - - architecture, advertising, design
 • Database - - personnel, stock control, manufacturing
 • Scientific Analysis - - medical, research, industry

- Desktop publishing - - newsletters, catalogues, manuals
- Multi media - - presentations, point-of-sale, training
- Graphic Design - - architecture, advertising, design
- Database - - personnel, stock control, manufacturing
- Scientific Analysis - - medical, research, industry

With the ION-PC 260 Kit you can finally explore the endless possibilities offered by having high-quality, full-colour still video images on your PC. For more information fill in the coupon below and return to:

Canon Europa, Still Video Department,
 P.O. Box 2262, 1180 EG Amstelveen,
 the Netherlands



Cat and Mouse?

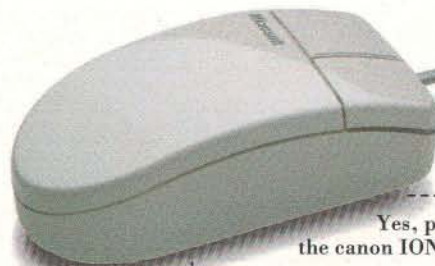

Yes, please send me more information about the canon ION - 260 PC Kit.

Name:

Address:

City:

Country:

Tel:

BY/06/06/92

Canon

ion
PC Kit

Still Video Camera RC-260

Shoot, see, and Manipulate

Canon and ION are registered trade mark of Canon Inc., IBM and IBM AT are registered trade mark of International Business Machines Corporation.

Circle 462 on Inquiry Card.

Hassle-Free Printer Sharing

for the HP LaserJet II, IID, III and IIID



"The ServerJet is the smoothest and most practical way I know to share a LaserJet."

Frank J. Derfler, Editor
PC Magazine

Here's how everyone in your office can have their own HP LaserJet printer without breaking the corporate budget.

It's called the *ServerJet*™.

Simply plug the *ServerJet* into your HP LaserJet. Stretch phone cable to each computer. Then up to 12 people can simultaneously *whooooossh* documents to the LaserJet at speeds as fast as 115,200 baud.

The *ServerJet* is available in a variety of models with up to 4MB of buffer memory to spool your print jobs.

To order your *ServerJet* or for more information, call one of ASP's authorized distributors:

- | | |
|---|--|
| Australia
Sprinter Products Pty Ltd
Tel: 2-9778155
Fax: 2-9762442 | Netherlands
Switch Components
Tel: 74-503550
Fax: 74-503444 |
| Belgium
Info Universe
Tel: 52-200183
Fax: 52-224785 | Switzerland
Dantronic Datacom AG
Tel: 55-485200
Fax: 55-482424 |
| France
Livingstone Technologie
Tel: 1-69070769
Fax: 1-69070060 | United Kingdom
Peripherique
Tel: 252-812249
Fax: 252-812342 |
| Germany
Dantronic Vertriebs GmbH
Tel: 8382-78043
Fax: 8382-74768 | Printware
Tel: 705-877111
Fax: 705-871111 |



ASP COMPUTER PRODUCTS, INC.

160 San Gabriel Drive, Sunnyvale, CA 94086, USA
Telephone: 408-746-2965 • Facsimile: 408-746-2803

ServerJet is a trademark of ASP Computer Products, Inc. / HP LaserJet is a registered trademark of Hewlett-Packard Co.

and confusing. This serious reservation aside, The Monotype Typeface Library offers a much more professional approach to type than does The Serials Typecollection.

The fonts on this CD are well known, established, widely used, and from large type foundries. There are designs from many of the world's leading typographers, and every font is guaranteed to be compatible with copies in typesetting bureaus. This means you can buy the Monotype CD and send your file off to be typeset even if the bureau does not have the CD. As long as it has the relevant font, it won't matter where it came from.

The Monotype Typeface Library also differs from The Serials Typecollection because it provides the proper italic versions of each typeface. Also, the quality of kerning in The Monotype Typeface Library fonts is well known. The availability of 1500 kerned pairs is yet further confirmation of the greater quality of the type in The Monotype Typeface Library.

Another difference is that The Monotype Typeface Library costs just £99. For that, you receive 12 fonts, making them £8.25 each. The remaining 1500 fonts on the CD are locked—protected by the password system—and can be used only after payment of at least £40 each. If you want to have the entire collection, it costs approximately £18,000, which is £12 per font—17 times more costly than The Serials Typecollection.

A further benefit of The Monotype Typeface Library is that the fonts can be made to work with Hewlett-Packard printers using PCL (Printer Control Language). The Serials Typecollection is restricted to PostScript printers and bit-map machines that can support TrueType.

The Monotype Typeface Library contains the entire Adobe Typeface Library, Monotype's own collection, called Classic Fonts, and the typefaces from Font Bureau. The Monotype CD works on CD-ROM drives attached to a PC or a Mac. The Serials Typecollection CD is available only for the Mac, with a PC version due out soon.

Choosing the Best

If you want quality fonts, you should opt for The Monotype Typeface Library or Type On Call from Adobe. The Serials Typecollection has some serious faults for publishers and others who want quality type. Also, if you want to save money, go for The Monotype Typeface Library: You get 12 fonts for your £99, and you may need to spend only a few hundred pounds for the handful of fonts that you'll need

ADS

(Europe) Ltd.

***NEW* NEXT DAY! DELIVERY TO MOST PARTS OF EUROPE
WE GUARANTEE TO BEAT ANY ADVERTISED EEC LANDED
PRICE ON MEMORY MODULES.**

OR WE WILL EAT THIS ADVERT!!

*Transport Cost from £7 in EEC. (4-DAYS)*NO EEC IMPORT DUTY. *100% Compatible. *5 Year Warranty. *Easy to Install High Quality products *Full Range of Products.

For Parts Not
Listed Please
Contact US.

For a Fast Response Contact Us **FIRST** on
Tel:372-1917 or Fax:625-7649 (7Lines)
Codes: (UK 071) , (International 4471)

30-Days Money
Back Guarantee

Part	Ref	Price £	Part	Ref	Price £			
AT Memory Cards								
Boca AT Plus*5 Years Warranty*LIM 4			T1200XE	2MB	68			
2MB £116 - 4MB £164-8MB		£260	T1600	2MB	68			
AST								
Premium Exe.Note Bk	4MB	130	T3100SX	2MB	68			
Premium	4MB	110	T3100SX	4MB	142			
Premium	8MB	280	T3200SX/C	2MB	68			
Compaq								
E & S Same Price 4MB Module		115	T3200SX/C	4MB	142			
E & S Same Price 4MB Card		161	T5100/T5100C	2MB	73			
386/33 115144	2MB	66	T5200/T8500	2MB	73			
486/33 116561	8MB	221	T5200/T8500	8MB	278			
486/33 116568	32MB	1210	Laser Printer Memory					
486c 128877	8MB	205	HP IIISi	1MB	52			
Slt/386 110237	4MB	122	HP IIISi	4MB	149			
Lte/386 1121125	4MB	178	HP III/IIID/IIIP	1MB	42			
Lte/386 Lite *NEW*	8MB	Call	HP II/IIID	2MB	75			
DEC								
DEC-STATION/DECSys	4MB	194	IBM Laser 4019/E	1MB	55			
Deckit Station/DESSys	16MB	840	Panasonic 4450i/4420		55			
VaxStation 3100	8MB	423	Epson EPL 6000	1MB	55			
DELL								
325P,333D/P	4MB	103	Epson EPL 7000	1MB	55			
SG 4D/120	8MB	298	OKI Data 400	1MB	69			
Epson								
Equity IIE,386/20/25	1M	55	OKI Data 800/820	1MB	120			
Equity IIE,386SX	2MB	90	Cannon LBP-4	1MB	133			
IBM PS/2								
2MB 6450604		65	LaserPix 3.0 *NEW*					
2MB 6450608		65	Increases Resolution of HP LASER					
MCRAM32 Plus *** NEW ***			Printers to 2400 DPI					
Up to 128MB of Memory(OK)		169	Sample output.					
NEC								
4-8MB PowerMate SX+		399						
2MB PowerMate 386/25		160						
Sun279								
16MB Sparc4/40/60/65		580						
Toshiba								
T1000/T2000	2MB	95						
T1000/T2000	4MB	205						
T1000/T2000	8MB	350						
T2000-SXE	2MB *NEW*	116						
T2000-SXE	4MB *NEW*	193						
T2000-SXE	8MB *NEW*	360						
T4400/T6600	4MB *NEW*	193						
T4400/T6600	8MB *NEW*	360						

This advert was printed using HP III
AND LASER PIX 3.0.

With No modifications

Software Packages

Full Range of all popular software packages at very low prices.

Special Offer Box

MS Window 3+DOS 5	69
Excel 3.0	237
MS Word for Window	237
PageMaker 4.0	385
Word Perfect 5.1for Window	193
Word Perfect 5.1 for DOS	193

Exclusive World Distributor. Multilingual Word Processor. Interlingual©

Supports over 20 languages. Allows coexistence of different languages alongside each other, In any combinations.(ie)Russian and Spanish, German etc.

Supported by various Compilers.£150

Hard Disk Drives

Connor/Fujitsu/NEC/Segate

Fax/Modem **Call**

Standard Memory

1MB by 9 (70ns)	25
256K by 9 (80ns)	15
Set of 9 1MB chips	25
Set of 9 256K chips	21

Lan Adaptors

Intel Netport	390
D-Link	250
Multiple I/O port-8	490

Coprocessors

HP IIIP (220V)	685
HP III (220V)	1005
HP IIID (220V)	1570
Toner Cartridges for HP IIIP	44
Toner Cartridge for HP III	49
Deskjet 500	273

HP 95LX,POQET MEMORY

Full Range of Static and Flash Memory
PCMCIA/JEIDA STD **CALL**

Address :
36A, Kilburn High Road
London NW6 5UA
UK

Prices are subject to change without notice.
Payment by : VISA/ACCESS/Master Charge
Wire Transfers/LC/Money Orders.

Advertised Prices are in UK Sterling. Payments Can be In UK Sterling or US Dollars. All Trade Marks are recognised.

Psion Dacom Delivers One Modem for Europe

The PDM40F is one of a new range of pocket modems from Psion Dacom that can act as a V.22bis (2400-bps) modem with V.42bis error correction and data compression. It can also send and receive faxes from Group 2 machines at 9600 bps.

Psion Dacom has also added to the modem range a removable "personality module" that solves the problems of using a modem abroad. The module contains country-specific electronics for connecting to a public phone system and includes the correct connector for the wall socket.

The handsome unit has a gray plastic case that is roughly rectangular and about the size of a chocolate bar. The modem itself, however, is smaller than this image suggests, because the lower third of the case is actually the removable personality module.

The review machine that I looked at came with the U.K. adapter, which has a 2-meter lead with a British Telecom wall plug at one end. Other adapters may contain electronics to handle the quirks of different national public telephone systems or even radio communications. The removable section of the unit also bears a miniature jack socket for plugging into an optional acoustic coupler, which solves the problem less elegantly (and less thoroughly) but is also less expensive.

At the top of the case is a calculator-style LCD screen that, I'm delighted to report, actually shows useful information rather than those three-letter signal acronyms that have meaning only for communication engineers. The LCD shows you the power and battery status, line speed, error correction and compression status, and whether you are in fax mode. It also flickers the state of the Rx and Tx lines.

Set in a sloping step in the



middle of the PDM40F's case are three large yellow buttons for power on, power off, and standby mode. You can power the PDM40F from two AA alkaline batteries, an optional rechargeable nickel-cadmium pack, or via an adapter.

The modem exploits Psion Dacom's expertise in power-saving circuitry, which the company developed for the MC and Series III computers. As a result, you get around 8 hours of operation from two AA cells (at 2400 bps with V.42bis compression), or even longer when you run the modem at slower speeds.

Standby mode puts the PDM40F into a power-saving state from which it awakens when it receives a ringing tone. Regrettably, you cannot wake the modem from standby mode simply by sending AT commands from your communications software. Thus, standby mode is of little practical use to portable PC users. Waking up the modem from the terminal end requires a special hardware signal con-

nected to pin 11 of the RS-232 interface, and this feature is intended principally for embedded remote data-logging applications.

It would be nice to be able to report that the bundled software is as excellent as the modem, but I'm afraid I can't. Both Breakout Plus (the communications program) and Breakout Fax are text-mode programs with old-fashioned and cumbersome user interfaces. Breakout Plus has plenty of features, including Kermit, XMODEM, YMODEM, and ZMODEM file transfer protocols, but it has a crude log-file control and no learn mode or script language. To automate log-ons, you have to assemble bizarre strings of flashing control characters. Anyone who wishes to use it to do more than just dial a service and read from the screen will quickly become frustrated.

Breakout Fax is better, but it's still very far from being state of the art. The program is based around an on-screen dialing directory with pull-

down menus for control. There is a small memo editor that lets you construct and send simple text faxes quickly. You can capture graphical printer output from other programs to send as faxes, but the awkward file browser and the fact that you need a separate program to view faxes make it all rather tedious.

Under DOS, you can send and receive faxes with Breakout Fax operating in the background as a TSR program, where it occupies a thumping 256 KB of memory. Under Windows 3.0, however, I was not able to make the background facility or the printer-capture feature work at all.

The Psion Dacom PDM40F is an excellent modem for anyone who needs to communicate while traveling; it may be the first modem that's designed from the start to be international. But you can do much better by using, for example, Odyssey and DOSFax (or WinFax Pro and DynaComm under Windows) instead of the bundled software.

—Dick Pountain

THE FACTS

PDM40F

with communications and fax software, £499; acoustic coupler, £75; mains adapter, £15; rechargeable battery pack, £20; extra national public-telephone-network adapters, £50 to £70

Psion Dacom plc.
Dacom House
Presley Way
Crownhill
Milton Keynes
MK8 0EF
U.K.

44-908-261686
fax: 44-908-261688

Circle 1071 on Inquiry Card.



SOMEONE WILL BE PRICE DIS-ORIENTED

It's inevitable. Faced with the superior quality and moderate prices of our monitors, someone will be disoriented. And to obtain the same results, they are going to discover that many things are necessary - high specialization and large scale productivity, assembly line automation, fully independent ability to construct each individual component. But industrial efficiency is not enough. Production must undergo severe quality control and the toughest of all tests: «Burn-in under extreme conditions», to which all of our monitors are constantly subjected.

All this in full respect for European community regulations on standards for safety and electromagnetic emissions. Lastly, they will have to take into account Italian design and a complete range of monitors offering models of long-term stability. And a sales organization which is always ready to fulfil any request, as regards both delivery of products and technical assistance. So our competitors' dismay is not surprising and their disorientation is fully justified, although we ourselves are sure of achieving even better results in the future.



HANTAREX

A LEADING INDUSTRY IN MONITOR TECHNOLOGY

Headquarter: Via Perfetti Ricasoli, 78 - 50127 Firenze - Italy - Fax 39 55/4220129

UNITED KINGDOM
London
Tel. 44-81-778-1414
Fax 44-81-659-9348

GERMANY
Altenkirchen
Tel. 49-2681-3041/2
Fax 49-2681-7222

SPAIN
Barcelona
Tel. 34-3-3232941
Fax 34-3-4538163

GREECE
Athens
Tel. 30-1-9910950
Fax 30-1-9932801

HUNGARY
Budapest
Tel. 36-1-1832366
Fax 36-1-1145965

SOVIET UNION
Moscow
Tel. 95-3342974
Tlx 412160 ANTAR-SU

Circle 429 on Inquiry Card.

The Persistent POET Provides Powerful OOP Data Storage

Those familiar with OOP (object-oriented programming) no doubt know that the three cornerstones of the OOP faith are encapsulation, inheritance, and polymorphism. BKS Software claims that an additional cornerstone—persistence (or, specifically, a persistent object store)—is required to make OOP a truly practical technology for most applications. As a means to this end, the company offers **POET** (which stands for Persistent Objects and Extended Database Technology), an object-oriented database system.

Basically, a persistent object store is a store where objects, once created, exist until they are explicitly deleted, regardless of whether an application terminates or the objects go out of scope. By adding the keyword `persistent` to a C++ class definition, every instance of that class will be recorded in the object store.

The major disadvantage of the relational model is that any change to the relations, fields, or data types can require a considerable amount of work in reconciling the problems and incompatibilities that are created. With POET, you can make a change simply by inheriting the former class and adding the extra data types and programming methods required to process the new data-storage requirements. This is a neater and intrinsically more robust technique.

To use POET, you must make several changes to the way in which classes are defined. To make this process easier, the package includes a header-file compiler that takes a slightly modified header file and adds all the extra code needed by the C++ compiler to understand the persistent objects. Typically, you just add `persistent` to the start of the class definition, as in the following:

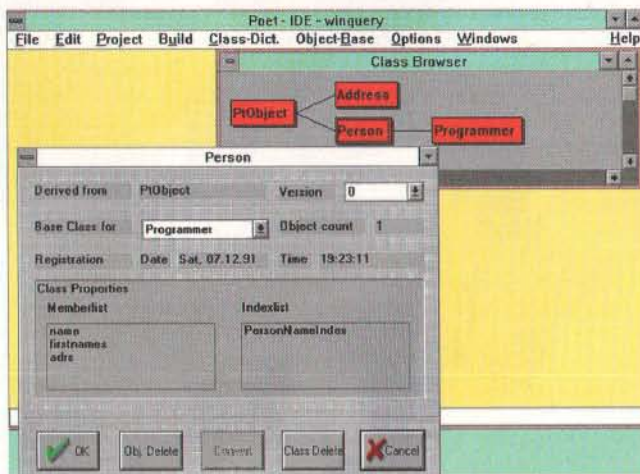

persistent class Pixel

```
{
public:
    int x,y;
    ...
}
```

You then save this in an .HCD file. The PTXX compiler then creates an .HXX file that includes the extra class information required for the object store. Typically, POET creates a modified class definition that would read `class Pixel:public PObject`. This simply inherits the new class Pixel from the POET object-store root class PObject. This then allows all the object-store container classes, which in this case would include `PixelAllSet` and `PixelQuery`, to be accessed in the main body of the application. These classes can then be used to access the objects in the store when required.

The PTXX compiler will also create an object store if one doesn't yet exist, register all the new or modified classes with that object store, and create the internal POET Factory class required to actually make the objects persistent. Although this all sounds rather complex, a quick run-through of the sample applications reveals that this is a neat and fairly comprehensive in-

terface to the object store.

To make this technology easier to use, BKS Software created a Windows 3.0 IDE (integrated development environment) that helps you to maintain the classes and compile the .HCD files. It also provides additional tools, such as an object browser and a source editor. The installed software comes with two examples—Winhello and Winquery—to help you adjust to the changes that using this system requires. I strongly recommend that you work through both examples carefully before working on your own application.

The IDE allows you to easily manage a project containing many classes and source files, and the class browser that is provided is excellent. You can examine all the characteristics and features of the class through a comprehensive dialog box (see the screen).

One feature that would be nice to have is the ability to actually compile the applications directly from inside the IDE. Instead, you are forced to leave the IDE and compile the application from the compiler's command line.

The only difficulty I had with compiling applications created with POET occurred when I tried linking while

using Borland's C++. It appears that the linker is pushed very hard by the POET libraries and requires extra memory above the 640-KB limit. The version of the EMM386 memory driver that I was using caused problems for Borland's TLINK. I resolved these problems simply by booting without EMM386 loaded, but this made running Windows 3.0 less efficient.

The only real problem I can see with POET is the difficulty that other applications have in sharing data held in the object store. Obviously, applications written specifically for the POET object store will work, but support for off-the-shelf applications for reporting, remote access, or spreadsheet manipulation will be much harder to obtain.

In general, however, POET is an excellent step forward for C++ developers. It's well worth a look if you are considering working on a major new project, although this product is not for the faint-hearted or for C++ amateurs: My user's manual is already very well thumbed. ■

—Andy Redfern

THE FACTS

POET 1.0
single-user DOS
version, £249

Requirements:
An IBM PC running
Windows 3.0 with 4 MB
of RAM, at least 6 MB
of hard disk space, and a
C++ 2.x compiler or
AT&T's cFront.

BKS Software
Guerickestrasse 27
1000 Berlin 10
Germany
49-30-342-3066
fax: 49-30-342-8413
Circle 1072 on Inquiry Card.

SOFTLINE® THE BEST BUYS IN OVER 170 COUNTRIES.

S O F T W A R E

* (Items in RED run under Windows)

Word Processors/Editors

Brief/Brief for C++	\$169/87
Brief+DBrief	231
Justwrite	132
Lotus Ami Pro	307
Microsoft Windows Word	286
Microsoft Word	223
Norton Editor	66
Professional Write	168
Sage Professional Editor	183
WordPerfect for Windows Upgrade	77
WordPerfect V5.1/NP Windows	269/269

Desktop Publishing

Adobe Type Mgr/ATM Plus Pack	63/127
Aldus Persuasion	335
Aldus Photostyler	537
Arts & Letters Graph Comp	256
Facelift	60
Form Publisher	189
Freedom of the Press Lite	54
Microsoft Publisher	132
Pagemaker	532
Per form Pro Designer+Filter	162
Publishers Powerpack WP/Windows	44/44
Publishers Type Foundry	322
Softype	117
Superprint	109
Ventura Publisher	537

Project Management

Harvard Project Manager 3	461
Microsoft Project	457
Superproject Expert/2 for OS/2	489
Timeline w/Graphics	465

Statistics

CSS Statistica	684
SPSS PC+ BASE PKG	168
SPSS PC+ Advanced Stastics	254
Statgraphics Plus	981
Systat w/Sygraph Graphics	773

Graphics

Adobe Illustrator	\$316
Adobe Streamline	124
Autocad	2703
Autosketch	148
Corel Artshow '91	164
Corel Draw	384
Design CADD 3D	197
Designer	474
DrawPerfect	292
Freelance Graphics/FG Windows	335/366
GEM Draw Plus w/GEM3 Desktop	161
Generic CADD	294
Harvard Draw	424
Harvard Graphics 3.0/HG Windows	413/350
Microsoft Powerpoint	327
PC Paintbrush IV Plus	117
Picture Publisher Plus	473
Pizzaz Plus	61
Windows Draw	93

Database & Tools

Advanced Revelation	735
B-Trieve	414
C-Tree Plus	451
Clarion Pro Dev/DBase III Lem	468/28
Clipper	519
Database	538
DBase IV/DBase IV Developer	504/669
DBlist	397
DBXL	133
Foxpro	480
Paradox	514
PC-File Single User	83
Q&A	265
RBase/RBase Personal	483/72
Superbase 4	480
UI Programmer	329
X-Trieve Plus	691

Integrated Packages

Lotus Symphony	513
Microsoft Works	99
Wingz	320

Spreadsheets

Lotus 1-2-3 Single/Server	\$350/660
Lotus 1-2-3/G for OS/2	513
Microsoft Excel	286
Microsoft PM Excel for OS/2	328
Quattro Pro	324

Network/Multiuser

NetWare 2.2 10 User/100 User	1147/3199
NetWare 3.11 5 User/10 User	695/1434
NetWare 3.11 20 User/250 User	2009/7197
NetWare LITE	70
PC-MOS 5 User	459

Desktop Environments

Desqview 386	\$133
HP New Wave	108
Microsoft Windows	89
Sidkick	55
Personal Information Managers	293
Lotus Agenda	243
Packrat	243
WordPerfect Office	89

Communications

Carbon Copy Plus	\$116
CC Mail DOS Platform/Win Platim	136/343
CC Mail 8 User Pack/25 User Pack	135/411
Close-Up Customer/Terminal	123
Crosstalk	120
Crosstalk Mark 4	136
DeVinci E-Mail 30 User	805
Dynacom Asynch Term Emulator	141
Microcouniter	58
PC Anywhere IV	120
Procomm Plus	66
Reflection 1+/7+	286/367
Reflection 2	235
Relay Gold	175
Smartcom III	110
Smartterm 240	207
Winconnect	61
Wintax Pro	74

Utilities

386 To The MAX	\$61
After Dark	28
Battery Watch	28
Brooklyn Bridge	90
Central Point Anti-Virus	84
Central Point Backup	76
Copy II PC	32
Direct Access	63
Fastback Plus	122
Goler	45
HDC Icon Designer	33
HDC Windows Express	55
Laplank Pro	104
Microsoft Windows Debugger	130
Multiscope Debugger for OS/2	299
Norton Anti-Virus	85
Norton Backup	86
Norton Commander	99
Norton Desktop	99
Norton Utilities	117
PC Kwik Power Pack	72
PCTools	112
Print D	83
PS-Print	245
QEMM 386 Exp Mem Mgr	61
QRAM 286	49
Saber Menu Pack	279
Software Bridge	74
Spiritrite II	61
Super PC Kwik	44

H A R D W A R E

Display Boards

ATI Graphics Ultra 512K/1MB	\$469/532
ATI VGA Wonder XL 512K/1MB	197/217
Boca Super VGA 512K/1MB	104/135
Hercules Graph Station 1MB/3MB	538/661
Video 7 V-RAM II 512K/1MB	254/329

Networking

3COM Etherlink 16bit CX PCA	299
3COM Etherlink 16bit CX 5PK PCA	1335
3COM Etherlink 16bit TP PCA	323
3COM Etherlink 16bit TP 5PK PCA	1498
Eagle NE1000 8bit Ethernet	131
Eagle NE2000 16bit Ethernet	162
Eagle NetWare LITE Starter Kit	422
HP Ethernet Interface 10BT	480
HP Token Ring Interface Novell	618
SMC Arcnet PC130 8bit CX PCA	77
SMC Arcnet PC130E 8bit CX PCA	107
SMC PC650FS Arcnet for FS 16bit	205
SMC PC650WS Arcnet for WS 16bit	128
Thomas Conrad Tin Ring MAU 16PT	644
Xircor Pocket Ethernet II 10BT	374

Printers

Canon Bubblejet BJ10EX	\$354
HP Deskjet 500/500C	413/756
HP Laserjet III/IIIIP	1627/1101
HP Laserjet III/SI	3792
Pacific Data 25-in-1 Font Cart	273
Pacific Data 2MB (2P, 3P, 3, 3D)	145
Pacific Data 4MB (2P, 3P, 3, 3D)	246
Pacific Page	368
Pacific Page XL PS Cart	800

Emulation Boards

AST 5251-11 Enhanced Plus	505
DCA IRMA 2/IRMA 3 (PCA)	729/430
Xircor Pocket 3270 Adapt Port	551

Input Devices

Caere Typist+ Ext OCR Scanner	386
Logitech Scanman Mod 256	273
MS Ballpoint Mouse for Laptops	125
MS Mouse HW Only-5PK (Bus/Ser)	383
MS Mouse w/Windows (Bus or Ser)	158
Summasketch 12X12 (4 or 16 butt)	334
HP Scanjet IIC w/Int (PCA or MCA)	1515

Please call for items not listed

SOFTLINE MAKES BUYING AS SIMPLE AS ...

1. Ordering



Fax your order & inquires to us 24 hours a day

1-718-438-2315



Call us at

1-718-438-6057

(9:00 to 17:00 U.S. EST, Mon.-Fri.) All prices and payments are in U.S.D., and do not include shipping, insurance, and other fees. VAT and duties will be collected at delivery. Please confirm prices, availability, shipping costs and other fees at time of order.

2. Shipping



Ask for Federal Express, DHL or UPS,

if you want 2 to 4 day service through customs to your door.

or



For large orders, we also ship via economic Air Freight, with 1 week delivery. Please confirm shipping costs when placing your order.

3. Payment



For fastest Ordering,

use your Visa, MasterCard, American Express, or EuroCard. Simply provide us with your credit card number, expiration date, shipping and billing addresses when ordering. A 3% surcharge is added.

Or you can...



Wire Transfer funds directly to our account at Manufacturer's Hanover Trust (ABA# 021000306) 4901-13th Ave., Brooklyn, NY 11219 Account No. 1042063596065. Please add \$15.00 wire transfer fee and applicable shipping charges. Allow 1 week for confirmation of transfer.



We accept bank checks in US Dollars payable on a US Bank. Send your order with payment.

TERMS: All prices are subject to change without notice. We do not charge your credit card until your order is shipped. All returns require prior authorization and RA number from our customer service department. (Minimum 20% restocking fee on returns). All returns are to be shipped prepaid and insured.



Confidence on a program:

"I've gained a new dimension. Now, I have time to understand the needs of the users. I have been promoted to project manager."



DEFI/CREATION

The ODYSSEE's generation is born :

1.

TECHNOLOGY UNDER CONTROL.

The computer technology is still on the move. Every day gives a new concept, a new environment, a new opening. You have to face situations more and more difficult to master with regard to the choice of the technology. Find your autonomy again with regard to this technology. Don't be dependent on your background. Move to the new generation, the future belongs to computer people who will be able to work out solutions matching the user's needs.

2.

OBJECT ORIENTED.

While describing the Objects, give your developments a new dimension. No more Editor, no more Code, no more Link. Describe Data Objects, Events and Tasks. Split execution and data from functions. Use predefined actions and a language exclusively business oriented. By default, the applications will be described automatically. That's the undertaking your applications will be expanded easily through other people, and for years.

3.

PROVIDING HIGH-TECHNOLOGY.

Odyssee is a High-Tech Development Tool. It's running on today's platforms released on the market: MS-DOS, UNIX, WINDOWS, NOVELL. Odyssee can access simultaneously a lot of Data Base Managers: UNIFY, ORACLE, XBASE (dBASE, Clipper, Fox Pro), DBVISTA, BTRIEVE. Odyssee can import/export LOTUS, WORDPERFECT, ASCII files. Odyssee can print on any line printer, Laser Postscript or HP. Odyssee includes his own COMPILER providing the data coherence, and will also optimize the execution speed. Odyssee can create HYPERTEXT applications, NETBIOS compatible on network, with a windowing environment.

4.

FREEDOM FOR YOUR USERS.

Whatever the requirements of your users, Odyssee will execute quickly any application, without limitations due to size or data volume. Odyssee has the expertise in taking decisions at execution time. The users will enjoy a progressive technology and won't be systematically guided while running the application. At any time, they can execute one of the tasks designed, with the full confidence that the data set will still remain consistent. At any time, the user can search through a data base, using criterions even not defined by the developer. The application will be a great hit.

MORE THAN 1500 PAGES ARE INCLUDED IN THE ODYSSEE'S HANDBOOK.



++ 41 21 923 63 77

CASE DESIGN / EUROPE
AV. GENERAL-GUISAN 26
P.O. BOX 708 CH-1800 VEVEY
FAX ++ 41 21 923 63 83

(512) 346 89 91
CASE DESIGN / USA
9111 JOLLYVILLE ROAD
SUITE 207 AUSTIN, TEXAS 78759
FAX (512) 346 79 20

NAME _____
COMPANY _____
ADDRESS _____ COUNTRY _____
CITY STATE ZIP _____
PHONE _____

QTY	DESCRIPTION	PRICE EACH	TOTAL
	<i>Odyssee</i>	\$1'300.*	

* STARTER KIT: MS-DOS, xBASE, SINGLE USER.
OTHER PLATFORMS: PLEASE CALL.
30 DAYS BACK GUARANTEE

CHARGE TO MY: VISA EUROCARD/MASTERCARD

ACCT. # _____ EXP. DATE _____ SIGNATURE _____



ODYSSEE
OBJECT ORIENTED
DEVELOPMENT TOOLS

FROM CASE DESIGN INTERNATIONAL

Circle 460 on Inquiry Card.

Car Adapters for Notebooks

The ADA range of car adapters features a power supply that protects against short circuits and power overloads. In addition to powering your portable PC, they charge their internal batteries so they are always ready for use in the field. Each unit consists of a cigarette-lighter adapter at one end and a computer adapter at the other.

The DQ16 is a fast-charge device for Sanyo 17NB and 18NB notebooks, and the DC151 is a device for IBM N33 and PS/2 L40SX notebooks. The Adapter is a universal car adapter designed for higher-power-output computers such as the Toshiba 2000, 4000, and 6000 series, as well as for models from Sharp, Mitsubishi, and Amstrad and the latest color portables.

ADA Computer Systems also offers the WonUnder Cradle docking station, which supports the IBM PS/2 Model L40SX, Texas Instrument TravelMates, Sharp notebooks, CompuAdd Companions, and the Compaq LTE. It consists of a base unit that houses one full-length 8- or 16-bit ISA expansion card and the electronics for interfacing the unit to the host computer. An external power supply provides for the needs of both the expansion card and the host computer.

Attaching to the bottom of the host notebook, the WonUnder Cradle takes up no more space than the computer itself and adds little to the thickness of the notebook. In addition, the unit's wedge shape provides an optimal keyboard angle for the notebook.

Price: £149 each for the DQ16, the DC151, and the Adapter; £399 for the



Attaching to the bottom of a notebook PC, the wedge-shaped WonUnder Cradle performs the functions of a desktop docking station and portable expansion chassis.

WonUnder Cradle.
Contact: ADA Computer Systems Ltd., 185 London Rd., Burgess Hill, West Sussex RH15 8LH, U.K., 44-444-232000; fax 44-444-247754.
Circle 1339 on Inquiry Card.

Publish and Be Magnetic

If you've ever wanted to produce your own disk-based newsletter or magazine but felt you lacked the necessary programming experience to make the publication look good, then Wensum Software's Magazine Publisher may be for you. In addition to presenting your ASCII text files in an attractive fashion, the software lets you add facilities that can play music in four-channel sound from a basic IBM PC speaker and run external computer programs and batch-file routines.

Price: £79.95.
Contact: Wensum Software, 91 Glendenning Rd., Thorpe Park, Norwich NR1 1YN, U.K., phone and fax 44-603-630912.

Circle 1340 on Inquiry Card.

Extended Optical-Density Scanner

Designed for use in medical, dental, and biotechnical applications, the XRS OmniMedia 6cx scanner features an extended optical-density range and can scan prints, transparencies, 35mm slides, negatives, and even fabric at resolutions of from 75 to 600 dpi. The scanner is also capable of digitizing low-contrast, dark transmissive

images such as x-rays and gels measuring up to 8½ by 14 inches.

When you combine the scanner and an IBM XT, AT, or PS/2, you can view, diagnose, archive, print, and electronically transmit any x-ray. The OmniMedia 6cx is also capable of digitizing color or black-and-white reflective artwork for desktop publishing tasks. For color scanning, the scanner operates at 24-bit resolution and captures up to 16.8 million colors. For imaging x-rays, the OmniMedia 6cx features 8-bit gray-scale scanning to digitize 256 gray shades. In addition, a single-bit scanning mode allows the 6cx to scan text from journals, publications, and other documents directly into a word processor via optical-character-recognition software.

The XRS OmniMedia 6cx lets you set the image sizing from 25 percent to 400 percent and offers 14 brightness settings per color. The scanner package includes a copy of PhotoStyler.

Price: £5400.
Contact: IMC, 281 St. Leonard's Rd., Windsor, Berkshire SL4 3DR, U.K., 44-753-830999; fax 44-753-831094.

Circle 1341 on Inquiry Card.



For medical, dental, and biotechnical applications, the XRS OmniMedia 6cx scanner features an extended optical density range and can scan prints, transparencies, 35mm slides, negatives, and even fabric.

17-inch Color Monitor

Compatible with most popular graphics cards, the Ranger 4317 color monitor automatically synchronizes at horizontal frequencies between 30 and 75 kHz and vertical frequencies between 50 and 90 Hz. The 17-inch flat square tube monitor also has an antiglare screen with a dot pitch of 0.26 mm for clear, sharp images.

The monitor displays flicker-free resolutions of up to 1280 by 1024 pixels non-interlaced at 70 Hz, making it ideal for applications such as CAD, imaging, and Windows. The Ranger 4317 features a microcontroller that lets you store up to 14 preset resolutions in memory, and the presets automatically provide full control of picture height, width, position, and barrel and trapezoid geometry at the selected resolution. The Ranger 4317 has a tilt-and-swivel base and external dimensions of 411 by 388 by 435 mm.

Price: £1310.

Contact: Aydin Controls (U.K.) Ltd., 1/3 Hunting Gate, Hitchin, Hertfordshire SG4 0TJ, U.K., 44-462-458804; fax 44-462-456761.

Circle 1342 on Inquiry Card.

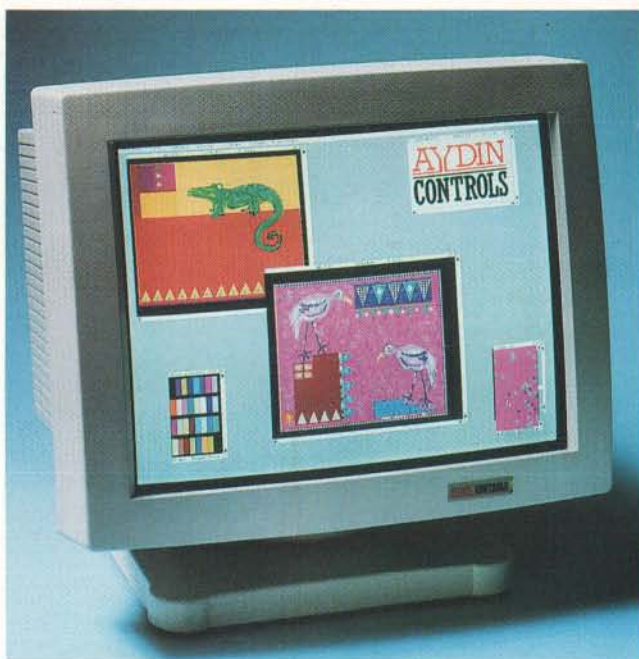

The Ranger 4317 color monitor automatically synchronizes at horizontal frequencies between 30 and 75 kHz and vertical frequencies between 50 and 90 Hz.

High-Speed Modular Data Switch

A modular data switch from Adder Technology combines parallel and serial communications, file transfer capability using industry-standard software, and data transfer over long distances. The Modular Smart Switch can house up

to six plug-in modules, each with two communications ports, for a total of 12 ports per switch, either parallel or combined RS-232/RS-422, in any combination.

The Modular Smart Switch's memory is also modular, so you can upgrade the basic 512-KB switch via 512-KB, 1-MB, and 2-MB plug-in memory-expansion cards to a total of 4 MB. In addition, Adder Technology's high-speed serial utility, called Ad-Mode, allows the PC's serial ports to be driven at up to 57,600 bps.

The switch can drive laser printers that are more than 1000 meters away without the need for external distance boosters. When the destination device has no RS-422 port, you can still transmit the data in RS-422 format from the Modular Smart Switch and use a single external adapter to convert it for input into the destination device.

All the functions of the

Modular Smart Switch are controlled from the connected PC either using the Windows-compatible pop-up software or, in the case of a terminal, sending a text string.

Price: £395 and up; £75 each for combined RS-232/RS-422 and dual parallel modules.

Contact: Adder Technology, 140 Cambridge Science Park, Milton Rd., Cambridge CB4 4GF, U.K., 44-223-420912; fax 44-223-423495.

Circle 1343 on Inquiry Card.

A Software Mouse Alternative

NoMouse for Windows, a software replacement for a hardware mouse, provides precision pixel-by-pixel control of the mouse pointer; it even lets you display the mouse pointer coordinates. The package lets you use any Windows application in tight spots, such as car seats, trains, or airplanes, without plugging in cords or having to find a flat surface.

The EasyFind feature lets you enlarge the mouse pointer, so you can see it on even the most difficult-to-see LCD screens. The shortcut keys facility lets you quickly move to an edge or corner of a window or define a home screen position to which the pointer instantly jumps.

The NoMouse runs on IBM AT, 386, and 486 PCs with 30 KB of free hard disk space and Windows 3.0.

Price: £39.95.
Contact: GuildSoft Ltd., The Computer Complex, City Business Park, Stoke, Plymouth PL3 4BB, U.K., 44-752-606200; fax 44-752-606174.

Circle 1344 on Inquiry Card.

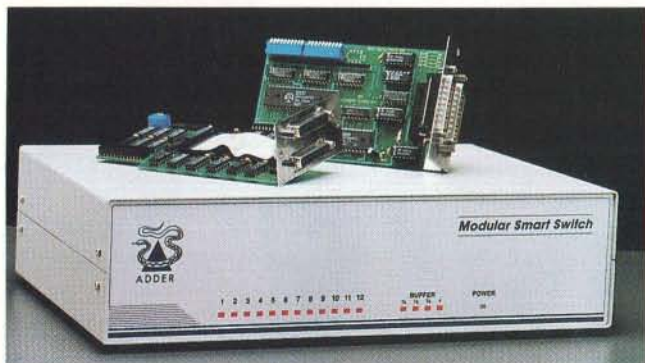

The Modular Smart Switch combines parallel and serial communications, file transfer capability, and data transfer over long distances.

Lemon computers: un marchio ormai da anni protagonista nello scenario informatico.

In un mercato sempre più complesso e competitivo Lemon vi offre la garanzia della sua decennale esperienza.

ONE RIGHT CONNECTION...



La gamma dei nostri prodotti è in grado di soddisfare qualsiasi esigenza applicativa, sia dal processore 80286 fino al veloce 486 con bus EISA. Tutti i modelli hanno un alto grado di affidabilità, grazie anche all'elevato standard qualitativo dei materiali utilizzati.

Qualità di prodotto e qualità globale, che significa un "team" di specialisti costantemente al vostro fianco per fornirvi consigli, assistenza tecnica e soluzioni più opportune.

Lemon computers, the right solution!

One & One

D-LINK: una sigla nel mondo del net-working informatico. Un mondo infinito di possibilità si apre di fronte a voi senza dover fare cospicui investimenti.

ONE BRIGHT CONNECTION

Con JEN e D-LINK non ci sono problemi. Si possono collegare in rete uno o più computers, incrementare la potenza, aggiungere un nuovo computer tutto questo senza difficoltà di installazione. Si possono scegliere tra i vari sistemi operativi LANSMART - NOVELL - UNIX, si aggiungono le schede ed è fatta! Tutto questo dà la possibilità di modulare i propri investimenti in sintonia con le proprie esigenze.

D-LINK the bright solution!

Circle 455 on Inquiry Card.

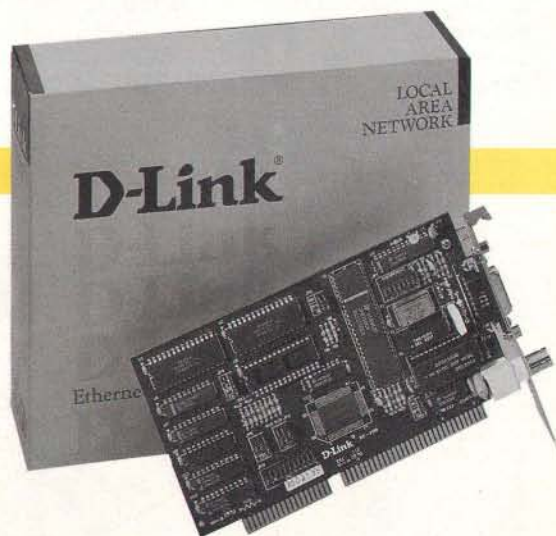

BDA communication

JEN ELETTRONICA srl

Zona Ind. E. Fermi - 62010 MONTELUPONE (MC) - Tel. 0733/224012 - Fax 0733/224035
MILANO - Tel. 02/2138676 - Fax 02/2138831 - Italia

LEMON
computers

D-Link

One Keyboard Controls Eight PCs

The HotKey PC range of video and keyboard switches lets you control a mixture of up to eight IBM XTs, ATs, PS/2s, and file servers using just one IBM AT keyboard and one analog CGA, EGA, VGA, or Super VGA monitor. Each of the unit's eight output ports is supported by a microcontroller capable of emulating an XT/AT keyboard and giving full support to the PCs you have connected to it. In addition, each output port draws its power from the connected PC, meaning that it continues to operate even when you switch off the HotKey. You can customize the device to your requirements using programmable options such as key-trap routines for channel switching, defining certain channels as read-only, and activating an audible keyclick.

Although the HotKey has either four or eight output channels, you don't need to connect all of them. The device automatically checks to see which channels are in use and prevents you from accidentally selecting any channel not connected. The front-panel display shows you

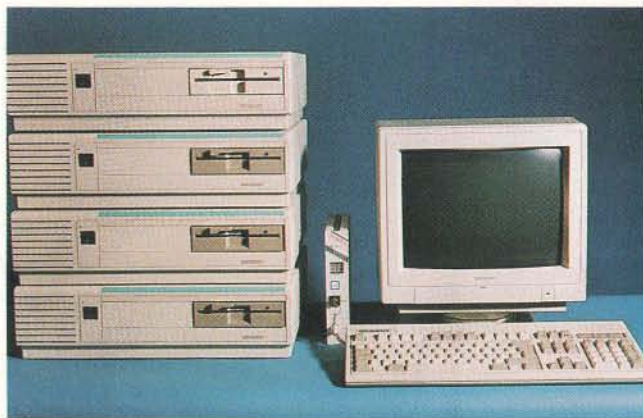

The HotKey PC range of video and keyboard switches lets you control up to eight PCs from a single keyboard and monitor.

the currently selected channel of communication.

Four models are available: the HotKey 8VK eight-way PC video/keyboard switch, the HotKey 4VK four-way PC video/keyboard switch, the HotKey 4K four-way PC keyboard-only switch, and the MF HotKey four-way keyboard sharer for multiscreen mainframes. **Price:** £1195 for the HotKey 8VK; £715 for the HotKey 4VK; £570 for the HotKey 4K; £695 for the MF HotKey.

Contact: Digital Developments Ltd., Unit 3, Herringston Barn, Dorchester, Dorset DT2 9PU, U.K., 44-305-250970; fax 44-305-250960.

Circle 1345 on Inquiry Card.

Instant Data Capture with a Pen

With ScriptWriter II, you can create a computer record and a paper copy simultaneously. The electronic clipboard lets you use a ballpoint pen and standard paper forms to input data. The unit's A4-size pressure-sensitive surface senses pen strokes from underneath the paper and converts your hand-printed characters into ASCII codes.

A two-line LCD panel displays characters as you write them. A validity checker ensures that you have correctly completed mandatory fields, beeping when it senses incomplete or invalid data and directing you to the field in question. You can save a form only when it has passed all tests, and you can download captured data to your central system through the ScriptWriter II's RS-232 port.

The internal rechargeable and removable battery pack provides up to 12 hours of continuous use. The ScriptWriter II has an internal clock for time and date stamping of data, and it can store over 100,000 characters. Options include a bar

code wand and an internal modem.

Price: £1875.

Contact: Peripheral Vision Ltd., West Hill House, West End, Frome, Somerset BA11 3AD, U.K., 44-373-452755; fax 44-373-452744.

Circle 1346 on Inquiry Card.

Quick File Access Tape Streamer

Cristie Electronics' TS4250 QFA (Quick File Access) 250-MB tape streamer can access any file on your PC in about 2 minutes. The QFA system works by using one track on the tape cartridge to physically record the location of each data file. This, combined with a tape directory at the beginning of each tape, makes access to data much faster. The QFA streamer can read non-QFA tapes.

The TS4250 QFA tape streamer is available with a choice of interfaces, including a parallel interface for connection to your PC's printer port. Backup rates can be as high as 6.5 MB per minute, depending on the adapter and PC you use. The tape streamers come with software that supports DOS and NetWare systems. **Price:** £1195; £99 for a parallel interface adapter. **Contact:** Cristie Electronics Ltd., Bonds Mill, Stonehouse, Gloucestershire GL10 3RG, U.K., 44-45-382-3611; fax 44-45-382-5768.

Circle 1347 on Inquiry Card.



The ScriptWriter II electronic clipboard lets you create a computer record and an original paper copy simultaneously.

This printer knows how precious your time is.



New from Minolta: Laser Printer SP3500.

See for yourself how the new Laser Printers SP3500 and SP3000 can be real time-savers in your business. Thanks to powerful RISC technology (AMD's 29K[®] 1 family) they feature extremely fast data-processing speed, giving the least possible delay between data transfer and printing. You get 10 pages per minute in a superb print quality. The unbeatable com-

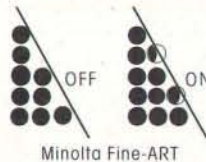

Minolta Fine-ART combination of

Minolta Fine-ART (Advanced Resolution Technology), the brilliant Micro-Toning System, Truelmage[™] 2 software (standard for SP3500 and optional for SP3000), Font Flexibility and Multi-Emulation. So ... don't waste a second making up your mind.

Fax · Copiers · Laser Printers

Minolta. The simplicity of intelligence.



MINOLTA

Minolta GmbH · B.E.O. · In den Kolkwiesen 68 · D-3012 Langenhagen 1 · Tel. (05 11) 77 00-0

¹ 29K[®] is registered trade mark of Advanced Micro Devices, Inc. ² Truelmage[™] is trade mark of Microsoft[®] Corp.

Circle 441 on Inquiry Card.

Hand-Held PC with Full-Size Display

Husky Computers says that its Husky Hunter 16/80 is the first rugged hand-held computer to feature a full PC-standard display of 25 rows by 80 columns. The compact LCD screen has a display resolution of 640 by 200 pixels and features a selectable double-height mode for increased character size and integral backlighting, ensuring good visibility even under difficult viewing conditions.

The Husky Hunter 16/80 also provides rugged portability, 16-bit DOS computing power, transfer of applications directly from desktop PCs without modification, sending and viewing of messages, and on-line access capabilities for connecting to public or private radio networks and remote databases from most field locations.

Price: From £1499 with 512 KB of memory to £4099 with 7 MB of memory.

Contact: Husky Computers Ltd., P.O. Box 135, 345 Foleshill Rd., Coventry CV6 5RW, U.K., 44-203-668181; fax 44-203-680612.

Circle 1348 on Inquiry Card.



The Husky Hunter hand-held computer features a PC-standard 25-row by 80-column display.

Design Loudspeaker Systems

A software package for computer-aided loudspeaker system optimization and design, CALSOD 2.50 can simulate the sound pressure and impedance response of individual loudspeaker drivers. The package lets you include multiple drivers in system models and include the effects of geometric layout on interdriver time delays in the analysis, thus allowing CALSOD to compute the summed response of multiway loud-

speaker systems. CALSOD 2.50 also lets you define closed-box, vented-box, passive-radiator, band-pass, and filter-assisted low-frequency alignments using Thiele-Small parameters.

You can inspect the magnitude and phase of the summed sound-pressure response, the impedance of each loudspeaker, the input impedance of the crossover network and loudspeaker combination, the response of each filter when it is loaded by its driver, the filtered and unfiltered sound-pressure response of each loudspeaker, and the desired target acoustic response function. CALSOD 2.50 also lets you

specify multiple off-axis observation points for response calculations and produce overlay color screen plots for each location.

A circuit optimizer mathematically varies the components of user-defined passive or active crossover networks (with up to 60 components) to achieve a given target sound-pressure response function. An impedance curve-fit optimizer can quickly determine the Thiele-Small parameters of a driver and lets you design conjugate load-matching networks.

You can import data files containing sound pressure and impedance responses from popular PC-based measurement systems such as Ariel's SYSid, Audio Precision's System One, DRA Laboratories' MLSSA, and Audio Teknology's LMS. You can also import measurements taken at multiple observation points and use them directly with the crossover network optimizer.

CALSOD 2.50 requires a PC with 512 KB of RAM, DOS 2.11, a hard drive with 1 MB of free space, and a graphics adapter.

Price: \$A 449.
Contact: Audiosoft, 128 Orielt Rd., West Heidelberg 3081, Melbourne, Australia, phone and fax 61-3-497-4441.

Circle 1349 on Inquiry Card.

SA-9600

Stand-Alone RADIO MODEM

- ❑ Async/Sync RS-232 connection to virtually all types of computers
- ❑ 2400, 4800, 7200, 9600 BPS
- ❑ Encryption capable
- ❑ Up to 15-mile range; hundreds of miles with repeaters/amplifiers
- ❑ Full or Half Duplex

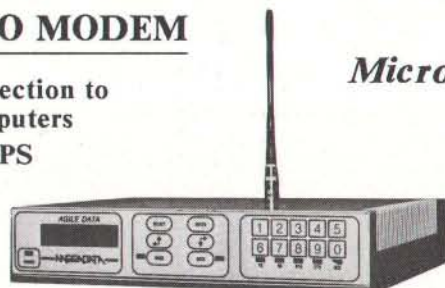

WIRELESS DATA COMMUNICATIONS for Micros, Minis and Mainframes

- ❑ Transparent radio link - no software modifications
- ❑ Voice and DC POWER options
- ❑ 400 - 500MHz Band (FCC CERTIFIED 450-470MHz)

PC-compatible plug-in board (PC-9600) also available

35 Orville Drive, Bohemia, NY, USA 11716

MEGADATA

TEL (01) 516-589-6800 • FAX (01) 516-589-6858

Hardlock E-Y-E[®] - tying the hands of software pirates

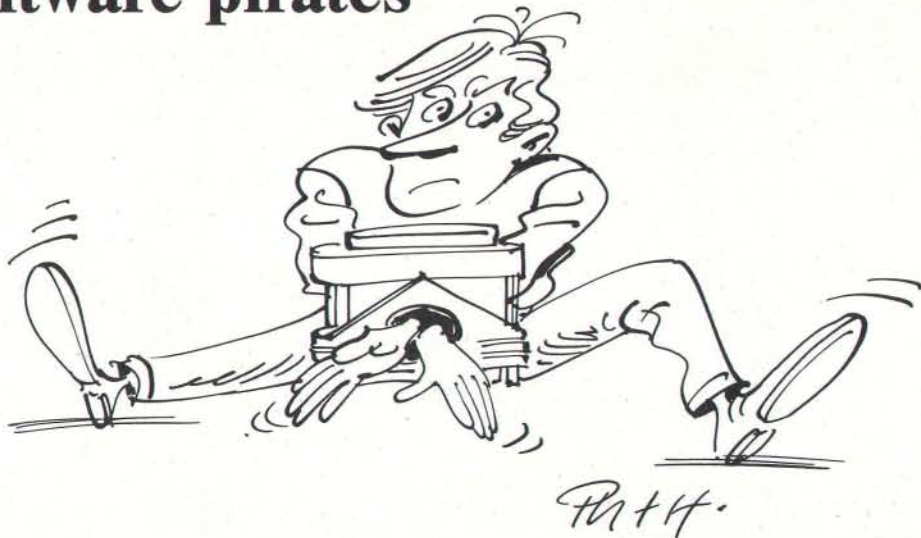

The effective way to protect your software

FAST Electronic has made life a lot harder for software pirates. Hardlock E-Y-E was designed using cryptographic principles. It took the experience and know-how of Germany's number one in software protection and the leading edge technology of a US semiconductor company to create the ultimate software protection tool.

The technology programmers have at their fingertips

Hardlock E-Y-E is based on a custom chip and combines all the features that a programmer would expect from such a device: secure, algorithmic query routines and an optional non-volatile memory for custom configurations. With the Crypto-Programmer card from FAST you can program the algorithmic parameters and the memory within seconds. This unique card guarantees that no one else can burn Hardlock E-Y-Es with your codes. Linking Hardlock E-Y-E to your software is easy: you can either protect your .COM and .EXE files with the automatic encryption software HL-Crypt or integrate FAST's high level language routines into your source code.

Readily acceptable to your customers

Hardlock E-Y-E allows unlimited backup copies of the master floppy. The customer gets the device together with the software and plugs it into the parallel port between the printer and the PC. Daisy-chainability, outstanding reliability and the compact high tech design guarantee that your customers will accept Hardlock E-Y-E.

The benefits your management will appreciate

Hardlock E-Y-E can be programmed by the software house with the Crypto-Programmer card. This ensures optimum delivery schedules and stock flexibility. Revenues will go up as software piracy and multiple usage are prevented.



Hardlock E-Y-E
programmable, algorithmic response
and memory option - all in one

Order your evaluation package today!

Contact B. Ajari at FAST Electronic or one of the offices below :

UK:

Magnifeye
Tel: ++44-71-2218024
Fax: ++44-71-7923449

France:

FAST Electronic S.A.R.L.
Tel: ++33-1-48837811
Fax: ++33-1-48839734

Spain/Portugal:

FAST Ibérica S.L.
Tel: ++34-1-3613222
Fax: ++34-1-3613219

Italy:

Techné S.R.L.
Tel: ++39-59-440690
Fax: ++39-59-440720

BeNeLux:

Crypsys Data Security
Tel: ++31-1830-24444
Fax: ++31-1830-22848

Greece:

FAST Hellas AE
Tel: ++30-1-6855 689
Fax: ++30-1-6472 304

USA/Far East:

Glenco Engineering Corp.
Tel: ++1-708-8080300
Fax: ++1-708-8080313

Hungary:

Szki Recognita Corp.
Tel: ++361-201-7973
Fax: ++361-201-7607

Yugoslavia:

G & G Electronic
Tel: ++38-41-211624
Fax: ++38-41-211604

FAST
Fast Electronic GmbH

Entry-Level 32-bit Computing

Elonex is attempting to raise entry-level computing to a higher plane with its 25-MHz 386SX-based PC-325X range. Housed in a tough plastic casing strengthened by a corrosion-proof, rigid steel cage, the Elonex all-in-one motherboard integrates the PC-325X's electronics assemblies into a single board. This permits a space-saving 34-by-38-mm footprint that still leaves room for three full-length slots and three drive bays in the Slimline M case and five full-length slots and five drive bays in the Compact B case. The motherboard provides 1 MB of memory (expandable to 16 MB), 16 KB of fast cache RAM (expandable to 64 KB), a connector for an optional math coprocessor, and a color Super VGA display adapter that offers up to 256 on-screen colors at a resolution of 800 by 600 pixels or 16 colors at a resolution of 1024 by 768 pixels.

The motherboard also includes a feature-bus connector that allows pass-through to high-resolution graphics cards, two nine-pin RS-232 ports, and a Centronics port. The floppy drive controller supports up to two devices, and there is also a connec-



The all-in-one motherboard of the Elonex PC-325X range permits a space-saving footprint while still leaving room for up to five full-length expansion slots and drive bays.

tor for IDE hard drives.

The PC-325X range features the Microid Research BIOS. The MR BIOS lets you optimize bus speeds, features a virus detector that traps software trying to write to the boot sector, automatically configures on-board memory upgrades, and allows setting of keyboard repeat and delay speeds. The MR BIOS also provides hardware-enabled, two-level password protection and offers shadow configuration for optimum system speed. **Price:** £895 and up.

Contact: Elonex plc., 2 Apsley Way, London NW2

7HF, U.K., 44-81-452-4444; fax 44-81-452-6422. **Circle 1350 on Inquiry Card.**

Measure and Analyze Coordinates

SigmaScan is a digitizing and morphometric measurement package for the IBM PC that you use with a digitizing tablet to measure and analyze 2-D areas, distances, slopes, and angles and to digitize *x,y* coordinates. Version 3.9 features a 16,000-column by

65,000-row data worksheet, enhanced data transforms for measurement analysis, and calibration functions.

The program also performs point, stream, and incremental *x,y* digitizing and object tallying, and it lets you collect multiple measurements simultaneously. SigmaScan 3.9 also performs descriptive statistics on the data, including size, sum, mean, minimum, maximum, standard deviation, standard error, confidence intervals, *t*-tests, linear regressions, and screen plots. In addition, the software can perform multipoint calibrations to adjust for rotated Cartesian axes and lets you construct nonlinear piece-wise calibration tables.

SigmaScan 3.9 requires a PC with DOS, 512 KB of RAM, a graphics adapter, an RS-232 asynchronous adapter, and a digitizer. The software lets you output data in standard ASCII files that are compatible with most popular programs, including Lotus 1-2-3 and dBase III and IV.

Price: 1150 deutsche marks.

Contact: Jandel Scientific GmbH, Schimmelbuschstrasse 25, D-4006 Erkath, Germany, 49-2104-36098; fax 49-2104-33110. **Circle 1351 on Inquiry Card.**

ZECKS SWITCHING POWER SUPPLY. COMPUTER CASE LOW NOISE, EXCELLENT PERFORMANCE



Computex booth No. G64

* 3-Digit Display
* White, Black Color

ZECKS MANUFACTURER & EXPORTER
ZECKS ENTERPRISE CO., LTD.

7F-1, No. 3 WUCHUAN 1ST RD., HSINCHUANG, TAIPEI HSIEN, TAIWAN, R.O.C.
TEL: 886-2-2992022-6 FAX: 886-2-2992027

Is ARCnet too slow...?

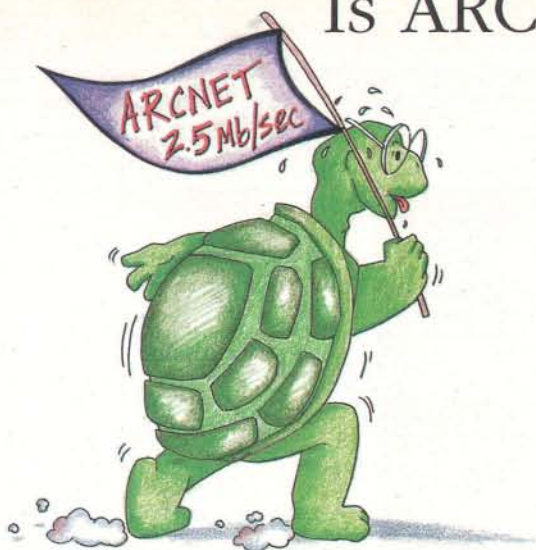

Not with ARC ARRAY™

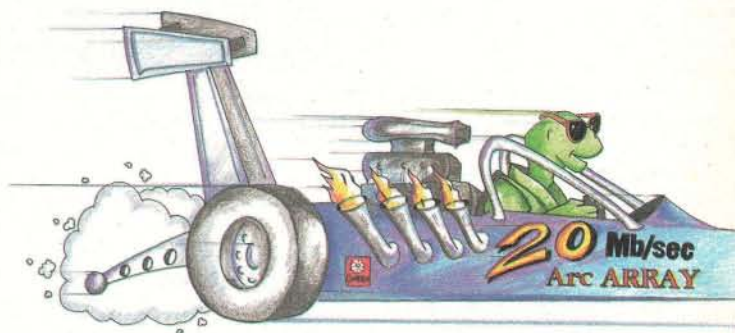

The new ReadyLINK ARC ARRAY adapter from COMPEX can increase your ARCnet network's throughput as much as eight times. This means a maximum network throughput of 20 Mbits/sec. compared to standard ARCnet's 2.5 Mbits/sec., Ethernet's 10 Mbits/sec., and Token Ring's 16 Mbits/sec. And, you can keep the same standard ARCnet adapters in your network workstations and the same standard ARCnet cabling and hubs.

ReadyLINK ARC ARRAY achieves this advantage by using the unique



COMPEX Multiport LSI ARCnet design. Because it uses only one ARCnet node address and receives data as a single node, ReadyLINK ARC ARRAY receives data at 2.5Mbits/sec. but transmits over up to eight separate channels for an aggregate transmit throughput of 20 Mbits/sec. Since, in a typical network, the file server spends over 90% of its time transmitting and less than 10% of the time receiving, your ARCnet network with ReadyLINK ARC ARRAY leaves comparable networks in its dust.

COMPEX, Inc., USA

4055 E. La Palma, Unit C, Anaheim, CA 92807
Tel: (714) 630-7302 • Fax: (714) 630-6521
Telex: 401987 COMPEX USA

Europe and Asia inquiries: COMPEX Systems Pte Ltd

4 Kim Chuan Terrace, Singapore 1953
Tel: (65) 2888220 • Fax: (65) 2809947
Telex: RS 35551 POWMAT

Trademarks: ARCnet, Datapoint Corp; Ethernet, Xerox Corp.

Circle 420 on Inquiry Card (RESELLERS: 421).

486 Workstations and Servers

Based on the second-generation 32-bit EISA chip set and Intel 486 microprocessors, Research Machines' E Series of workstations and servers incorporates RM's Advanced Memory Architecture, which provides a 128-bit-wide data path between CPU and RAM, supporting up to 256 MB of memory.

The desktop QE Series of machines includes the QE-486/33, which comes with a 33-MHz 486 microprocessor (with or without a cache), 8 MB of RAM, and a 170-MB hard drive; and the QE-486/50, which comes with a 50-MHz 486 microprocessor with a cache, 8 MB of RAM, and a 340-MB hard drive. The QE Series machines include a high-resolution HPGA graphics system that incorporates a 32,000-color Windows driver and an AutoCAD display-list driver. All machines come with DOS 5.0 and Windows 3.0.

The floor-standing



Research Machines' E Series SystemBase 486 file server can run Novell NetWare or RM Net LAN Manager.

SystemBase (SB) systems are based on 33- and 50-MHz 486 microprocessors. Hard drive options include 85 MB, 170 MB, 340 MB, 640 MB, and 1.3 GB. The SB-486/33 comes with the 33-MHz 486 microprocessor, 16 MB of RAM, and a 640-MB hard drive. The SB-486/50 comes with the 50-MHz 486 microprocessor with a cache, 16 MB of

RAM, and a 1.3-GB hard drive.

Price: £4270 for the QE-486/33; £6180 for the QE-486/50; £9935 for the NetWare Server SB-486/33; £13,505 for the NetWare Server SB-486/50.

Contact: Research Machines, Mill St., Oxford OX2 0BW, U.K., 44-865-791234; fax 44-865-796279.

Circle 1352 on Inquiry Card.

Low-Radiation Monitors

Three low-radiation monitors from Taxan conform to the latest standards for radiation and static emissions. The Ultravision 1095 LR is a 20-inch auto-scanning ultra-high-resolution color monitor that can display images ranging from VGA up to 1600 by 1200 pixels. The Ultravision 1075 LR is a 20-inch auto-scanning ultra-high-resolution monitor with microprocessor control. It supports display resolutions ranging from VGA up to 1280 by 1024 pixels. A low-cost, dual-scan Super VGA color monitor, the Supervision 787 LR is suitable for most general business applications.

Price: £2699 for the Ultravision 1095 LR; £1999 for the Ultravision 1075 LR; £449 for the Supervision 787 LR.

Contact: Taxan (Europe) Ltd., Taxan House, Cookham Rd., Bracknell, Berkshire RG12 1RB, U.K., 44-344-484646; fax 44-344-860981.

Circle 1353 on Inquiry Card.

LOW PRICES ON AMI MOTHERBOARDS

Authorized AMI Distributor

MARK V AMI MOTHERBOARDS

Mark V 386 25MHz 64K cache	\$522
Mark V 386 25MHz 256K cache	\$648
Mark V 386 33MHz 64K cache	\$558
Mark V 386 33MHz 256K cache	\$690
Mark V 386 40MHz 64K cache	\$594

SUPER VOYAGER AMI MOTHERBOARDS

Super Voyager 486SX ISA 20MHz 64K cache	\$600
Super Voyager 486SX ISA 20MHz 256K cache	\$822
Super Voyager 486SX ISA 25MHz 64K cache	\$780
Super Voyager 486SX ISA 25MHz 256K cache	\$1008

BABY VOYAGER AMI MOTHERBOARDS

Baby Voyager 486 ISA 33MHz 64K cache	\$1038
Baby Voyager 486 ISA 33MHz 256K cache	\$1170

SUPER VOYAGER

Super Voyager 486 ISA 50MHz 64K	\$1560
Super Voyager 486 ISA 50MHz 256K	\$1782

ENTERPRISE AMI MOTHERBOARDS

Enterprise II 486 EISA 33MHz 128K cache	\$1560
Enterprise II 486 EISA 50MHz 128K cache	\$2010

EZ-FLEX AMI MOTHERBOARDS

Ez-Flex EISA Base Board	\$648
Ez-Flex 486SX 20MHz CPU card	\$468
Ez-Flex 486SX 25MHz CPU card	\$648
Ez-Flex 386DX 40MHz CPU card	\$780
Ez-Flex 486DX 33MHz CPU card	\$1170
Ez-Flex 486DX 50MHz CPU card	\$1800
Fast Disk EISA SCSI Adapter	\$660

Call and ask about prices on HP, DEC, IBM, SCO, Microway, Seagate Hard drives, SAMPO and Cardinal products.

MasterCard and Visa Card accepted

Prices, availability and specifications are subject to change without notice. Always call for current prices. All sales are final, no exchange or refunds. The cost of the freight and insurance are not included in the price of the product.

JASON MACKENZIE INC.

1355 Peachtree St., N.E., Suite #1470
Atlanta, Georgia 30309 U.S.A.

Phone (404) 874-2500 or Fax (404) 874-4180

Hours: Monday - Friday 9:00 AM to 4:00 PM EST

DON'T GO TOO FAR!

Computers

Floppydrives

LAN products

Mainboards

Keyboards

ECG

Cases

U.P.S.

EUROPEAN COMPUTER GROUP

Plotters

YOUR EUROPEAN PARTNER

Printers

Peripherals

Notebooks

Harddisks

Digitizers

Monitors

Your business is safe with us!



European Headquarters:
European Computer Group B.V.
P.O. Box 116
5710 AC Someren
Netherlands
Tel.: 31-4937-90005
Fax: 31-4937-96808

Circle 459 on Inquiry Card.

**DEALERS OEMS
DISTRIBUTORS WANTED**

Dot-Matrix Personal Printer

Designed for end users, educational users, and small business users, the entry-level SP1900 Plus nine-pin dot-matrix personal printer offers quality printing, versatile functionality, and an outstanding price/performance ratio, according to Seikosha. The SP1900 Plus is able to print at speeds of 192 cps in fast mode, 160 cps in draft mode, and 40 cps in near-letter-quality mode.

The printer can handle various paper types and sizes, including A4, letter, legal, multipart stationery, continuous paper, and labels. In addition to a push tractor feed, the SP1900 Plus has a built-in semiautomatic sheet feeder, and you



With the SP1900 Plus, you can print on such paper sizes and types as A4, letter, legal, multipart stationery, continuous paper, and labels.

can easily switch between the two by activating the paper-parking facility. The printer

also offers a paper-end detection sensor and short tear-off facility. A cut-sheet

feeder is available as an option.

The SP1900 Plus has two built-in fonts—serif and sans serif—with a choice of numerous type styles and type sizes. Built-in Epson FX-850 and IBM Proprinter II emulations provide compatibility with most software. The printer includes a parallel interface, with a serial interface available as an option. Using the operator panel's touch-button controls, you can easily choose functions such as speed, quality, fonts, form lengths, and paperfeed.

Price: £155.

Contact: Seikosha (U.K.) Ltd., Unit 14, Poyle 14, Newlands Dr., Colnbrook, Slough, Berkshire SL3 0DX, U.K., 44-753-685873; fax 44-753-682036.

Circle 1354 on Inquiry Card.



CA-1701 17" Ultra Multiscan

KFC USA, INC.

1585 SUNLAND LANE,
COSTA MESA,
CA 92626 U.S.A.
TEL: 714-546-0336
FAX: 714-546-0315



June 5-9
A1030, A1032
A1129, A1131.

- Low Radiation
- Non-Interlaced



KFC MONITORS More Than You Expect...

With KFC, you need not sacrifice performance and comfort to safety.

KFC has been in the monitor industry for eight years. During this time, we have designed and produced monitors for the world's most critical OEM customers and distributors.

We offer a full line of high-performance monitors. Come to KFC and you will get products of a quality you can always count on!

Model/Spec. Description	14" Color				15" Color	17" Color
	CK-1406 (38K) Super VGA	CK-1406 (48K) Super VGA	CM-1410 Multiscan	CM-1413 Multiscan	CA-15 Multiscan	CA-1701 Multiscan
H. Freq.	31.5/35/38KHz	31.5/35/48KHz	30-50KHz	30-60KHz	30-60KHz	30-76KHz
Dot Pitch	.28mm	.28mm	.28mm	.28mm	.28mm	.26mm
Resolution	1024 x 768	1024 x 768	1024 x 768	1024 x 768	1024 x 768	1280 x 1024

*MB-0931 Mono VGA & MA-0931 9" Mono Monitors are also available.

Circle 425 on Inquiry Card (RESELLERS: 426)



Kuo Feng Corporation

Head Office:

346 NANKING E. RD., STE. 601, SEC. 3, TAIPEI, TAIWAN, R.O.C.

TEL: 886 (2) 751-5070 FAX: 886 (2) 721-6204 TELEX: 22225 KFCTPE

Specifications are subject to change without notice. All trademarks and registered trademarks are the property of their respective companies.



\$19.95

"Power C is a heavy-weight contender - at a bantamweight price"

Stephen Davis
- PC Magazine

"On sheer audacity for price-performance ratio, we loved Mix's products"

Tim Parker - Computer Language



\$19.95

"The Ctrace debugger is where Mix really shines. It is magnificent."

David Weinberger
- Computer Shopper



MIX
software

Power C

combines a high-performance C compiler with superb documentation, at a price that brings chuckles from over 50,000 satisfied customers. That's because Power C performs favorably against compilers costing 10 times as much. And you can't buy a compiler that's more reliable or easier to use - at any price. Perhaps that's why Power C has won Computer Shopper's Best Buy award for three years running.

- compatible with ANSI C standard
- integrated Make utility
- library of over 450 functions
- IEEE software floating point
- supports 8088/286/386/486 CPU
- memory resident program support
- supports 8087/287/387 math chips
- small/medium/large memory models
- mixed model with near/far/huge
- allows arrays larger than 64K
- CGA, EGA, VGA & Hercules graphics
- 650 page manual with tutorial

\$10.00

Power C Library Source

includes our Power C assembler, plus the C and assembly language source code to over 450 functions in the Power C library. Unlike our competitors, who charge \$150.00 or more for library source code, we've made ours very affordable.

\$10.00

Power C BCD Business Math

includes binary coded decimal floating point routines and financial functions to calculate interest, depreciation, etc.. BCD routines are used for dollars and cents calculations to eliminate inaccuracies caused by rounding.

Power C requires DOS 2.0 or later, 320K memory, 720K disk space. Master C requires DOS 3.0 or later, 384K memory, hard disk.

Power Ctrace

combines state-of-the-art technology with a friendly interface, making it very easy to find and correct your programming mistakes. No time consuming edit/compile cycles are needed to track down bugs. Simply compile your program once with the trace option, and Power Ctrace does the rest. Multiple windows display your C source code, the values of all your program variables, program output, watch points, and assembly instructions. Put Power Ctrace to work for you, and we guarantee that you'll be a more productive C programmer.

Order line:

1-800-333-0330

Technical Support:
1-214-783-6001

Fax: 1-214-783-1404

Mix Software, 1132 Commerce Drive,
Richardson, TX 75081

Get a FREE copy of Master C (limited time offer)

\$44.95 value FREE

Four 3.5" PC Disks Included

Mitchell Waite
Stephen Prata
Rev. Woodward

Published by the highly acclaimed Waite Group, Master C is a revolutionary book/disk package that turns your PC into a C instructor. Master C teaches you, quizzes you, notices problems you are having, and recommends action. In a pilot study at IBM, students using Master C retained 19% more knowledge than students who learned from a lecturer. Now you can receive this \$44.95 package absolutely FREE when you purchase all four Power C products described above. Just ask for the Master Pack.

"Master C eschews flash for elegant competence, and it works!"

Jeff Dunteman - PC Techniques

60 day money back guarantee

Name _____
Street _____
City _____
State _____ Zip _____
Telephone _____

Please send me a free brochure

Paying by: Check Money Order
 MC Visa Amex Discover
Card # _____ Exp _____

Disk Size: 5 1/4" 3 1/2"

Product(s) (Not Copy Protected)

Power C (\$19.95) \$ _____
 Power Ctrace (\$19.95) \$ _____
 Power C Library Source (\$10) \$ _____
 Power C BCD Business Math (\$10) \$ _____
 Master Pack (\$59.90) \$ _____
(includes all of the above plus Master C)
Add Shipping (\$5 USA - \$10 Canada - \$30 Foreign) \$ _____
Texas Residents add 8.25% Sales Tax \$ _____
Total amount of your order \$ _____

WE'VE CHARTED THE WAY WITH WIN++

...for Windows applications
in Borland C++

We've chosen the direction and plotted the course to easy and powerful Windows applications development!

With over 150 classes, Win++™ provides a simplified, flexible and powerful high-level C++ interface making your Windows development efforts a breeze.

Put the wind at your back...

Central to Win++ is that it provides a class for each type of display object in Windows. Win++ includes ready-made classes for representing dialog boxes, child controls, pens, brushes, menus, bitmaps, the cursor, icons, a printer, the clipboard and many others.

Win++ also supports the construction of dynamic-link libraries (DLLs), and the dynamic data exchange management library (DDEML).

It's smooth sailing from here out...

Win++ comes with a comprehensive reference manual and tutorial. Complete source code is included. You can rely on Blaise Computing to provide and support quality add-on libraries. We've been doing so since 1982 — it's our business — our only business.

Success is in the offing...

Win++ requires Windows 3.0 or later and Borland C++ version 2.0 or later. We're so convinced that you'll find Win++ essential to your applications that if during the first 60 days you're not completely satisfied, we'll refund your money. That's a 60-day money back guarantee!

Win++ and other Blaise Computing products can be acquired near you.

Australia...

MicroWay
(03) 580-1333

France...

Softworld
Paris
(33-1) 40 59 02 99

Germany...

ENZ EDV-Beratung GmbH
Bad Homburg
(061 72) 41014

SOS Software Services GmbH
Augsburg
(08 21) 57 10 81

The Netherlands...

Lemax Company B.V.
Badhoevedorp
(020) 659 8701

PC-Computing B.V.

Overloon
(31) 4781-42422

United Kingdom...

System Science
London
(071) 833 1022

Blaise Computing Inc.

819 Bancroft Way
Berkeley, CA 94710 USA
1 (510) 540-5441
FAX 1 (510) 540-1938

TMs are property of holders.

NEWS

INTERNATIONAL

Plug-and-Play Multimedia Kits

With VideoLogic's plug-and-play multimedia kits, you can set up and use multimedia applications quickly and easily. The six packages contain hardware, software, cables, and productivity and development tools.

The kits include VideoLogic's cross-platform, cross-operating-system range of DVA-4000 digital video adapters for IBM XTs, ATs, PS/2s, and Mac IIs; Multimedia Interactive Control I or II System software; a Super VGA graphics card; and serial, video, and monitor cables. The productivity and development tools complete the multimedia development packages.

VideoLogic has also added four software products to its line of MIC System software, a multimedia delivery and development operating system that provides control over the hardware components of a multimedia computer system. The new products are MIC System I 4.0, MIC System II 1.1 for Windows, MIC System II 1.0.1 for Mac IIs and System 7.0 computers, and CPI ImagePrep.

New features of MIC System I 4.0 include support for Super VGA mode; the ability to use EMS; Montage, a nonblanking merge feature for smooth, professional video merge effects; and enhanced control over video devices. CPI ImagePrep is designed for those who want to use desktop publishing applications in conjunction with multimedia systems. The software lets you convert images from graphics file formats such as TIF, TGA, PCX, GIF, BMP, and EPS into DVA images for use in multimedia applications.
Price: £1595 to £1795.

Contact: VideoLogic Ltd., Home Park Estate, Kings Langley, Hertfordshire WD4 8LZ, U.K., 44-923-260511; fax 44-923-268969.

Circle 1355 on Inquiry Card.

The Missing Link in Network Management

The missing link in the archiving of data on heterogeneous networks is the software to manage the archiving, backup, file migration, and retrieval process. The Network Archivist 2.0e helps you migrate files to other media, such as tape, and be confident that you will be able to retrieve them quickly.

The package uses an expert system and relational databases to manage the entire archival process. A master database records the location of all archived files, automatically copies all changed files to tape, and permanently saves all stable files to at least three tapes. The software guides you to where you can migrate infrequently used files to tape and provides instructions on which tapes to use and when. The Network Archivist also provides fast data restoration, media monitoring, virus detection, and Apple filename support.

Version 2.0e also allows unattended restores, provides optimized lists for the fastest restore operations, and has a facility that lets you restart interrupted restore operations at the point where they stopped.

Price: £795.

Contact: Palindrome (U.K.) Ltd., Burlington Court, Burlington Rd., Slough, Berkshire SL1 2JS, U.K., 44-753-810751; fax 44-753-810624.

Circle 1356 on Inquiry Card.

For those who appreciate the art



of Creating Computer Programs

You need a "special kind" of programming environment that lets you convert your most artistic thoughts into your application.

You want an "all-in-one" programming environment — with all the tools you need — for creating high-quality, feature-rich applications.

You expect a "fast and powerful" programming environment that performs with instant results — so you can create a "masterpiece" that will endure the test of time.

You deserve the Clarion Professional Developer.

The Clarion Professional Developer redefines the way that you develop PC application programs.

It puts you in full control of your application — opening up new, creative potential for the programming artisan.

Professional Developer is a fully-equipped development environment. With 14 dynamic utilities and the rich, comprehensive Clarion language — it gives you all the tools you need to design, develop, debug, and deliver complete, expressive applications.

Professional Developer is fast — it lets you turn your ideas into applications in much less time. A fraction of the time than the old-fashioned way of programming.

And with Professional Developer, your applications stand the test of time. You can create new or modify existing applications, as quickly and frequently as your application needs change.

Never again will too little time or limited tools restrict you from creating the kinds of applications you dream of. With Clarion Professional Developer this never happens...you're just a few seconds away from capturing the true art of application development.



1990
- FINALIST -
PC Magazine Award
for Technical Excellence



DEVELOPMENT TOOLS
Clarion Professional Developer
Version 2.1
Clarion Software Corp.

CLARION SOFTWARE™

150 East Sample Road
Pompano Beach, Florida
(305) 785-4555 • 1-800-354-5444

Circle 418 on Inquiry Card (RESELLERS: 419).

This is what **BYTE** (8/ 1991)
says about

CLASSNET

NEWS WHAT'S NEW • INTERNATIONAL

Computerized Classroom

Classnet from Minicom Advanced Systems is a dedicated communication network that gives instructors control over all activities, by all students, in the classroom.

...The Electronic Blackboard function lets you see a student's screen, display your own screen to any or all students, display a student's screen to the entire class, and send messages in real time to any or all students. The Interject function lets you disconnect the keyboard and darken the students' screens, giving you command over classroom activities.

By simulating the teacher's keyboard on a student's keyboard, the Assist function lets you help a student working in real time without losing visual contact with the entire class. The Communication function lets you prepare a lesson by transmitting work files to students; send data, text, or even an exam to all students; collect students' files at the end of a lesson or exam; and connect students to external devices such as videodisk players and modems.

The Print function lets you control one printer from the teacher's unit, while the Help function tells you that a student needs help, showing you the student's station number on your screen...

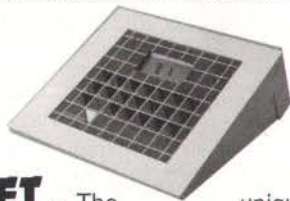

CLASSNET - The unique communication network, giving instructors control over all activities, by all students in the classroom.

For only US\$999 for the Teacher's Control Unit and US\$245 for the Student's Unit.

To find out the full facts about **CLASSNET** contact us at:



Minicom

Advanced Systems Ltd.

Diskin St., Villa 7

Jerusalem 92473, Israel

Tel: 972-2-663743, Fax: 972-2-637576

NEWS

INTERNATIONAL

Integrate EndNote Plus into Word 5.0

The EndNote Plus Plug-in Module integrates the bibliographic software EndNote Plus into Microsoft Word 5.0 for the Mac. The module provides you with access to your database of bibliographic references from within Word via commands added to Word menus. At any time, the module can build a bibliography and format the in-text citations according to a desired bibliographic style.

The module adds three commands to Word 5.0's menus. When you add the command EndNote Plus Module to the Tools menu, it opens your library. You add the commands Insert Citation and Format Citations to the Insert menu. The module lets you point to a reference in the library and use Insert Citation to insert an embedded object into the text as you write. With the Format Citations command, you can create a formatted bibliography based on the embedded citations in the text.

For formatting footnotes, the EndNote Plus Plug-in Module includes a preference that lets you specify whether you want citations in footnotes to be formatted as citations or as full bibliographic references.

The EndNote Plus Plug-in Module is included with the EndNote Plus software. A PC version is also available.

Price: £35 to registered EndNote Plus users; £189 with EndNote Plus.

Contact: Cherwell Scien-

tific Publishing Ltd., The Magdalen Centre, Oxford Science Park, Oxford OX4 4GA, U.K., 44-865-784800; fax 44-865-784801.
Circle 1357 on Inquiry Card.

Language Courses for the Mac

GuildSoft offers LinguaROM II, a CD-ROM-based collection of HyperGlot Software's 30 language-learning courses for the Macintosh. The 30 courses use seven languages (i.e., Chinese, French, German, Italian, Japanese, Russian, and Spanish), with each course concentrating on a particular aspect of the learning process, such as basic vocabulary building, pronunciation, verbs, and grammatical tenses, as well as special requirements for particular languages, including Chinese Writing Tutor, German Passive Voice Tutor, and Japanese katakana and kanji characters.

All the courses, except the basic vocabulary-building modules, use digitized sound, so you can hear the correct pronunciation and intonation from native speakers of the target language. Several of the programs support MacRecorder, so you can record your own voice to compare your pronunciation to the native speaker's.

LinguaROM II requires a Mac running System 6.0.7 with 1 MB of RAM (the company recommends 2 MB), a hard drive, and a Mac-compatible CD-ROM drive.

Price: £795.

Contact: GuildSoft, Wentworth House, Dormy Ave., Mannamead, Plymouth PL3 5BE, U.K., 44-752-251155; fax 44-752-604012.

Circle 1358 on Inquiry Card.

Compu\$ave

EXPORTING SINCE 1987

Int'l Orders (602) 437-8208

Info (602) 437-8298

FAX (602) 437-8988

COMPU\$AVE SYSTEMS

386-40 1325
486-33 1675

All Systems include: 1.2 FD, 4MB RAM, 64K CACHE, 100 MB IDE, Keyboard, 2 Serial, 1 Parallel, DOS, SVGA w/1 MB.

CALL FOR CUSTOM CAD CONFIGURATION

BOARDS

Adaptec 1542BK 273
Advanced Digital Save
Alloy Call
Artist XJ10/16 997
ATI Ultra 8514 w/1MB 542
Calcomp Draw Card 1529
Computone Call
Digiboard Call
DPT SmartCACHE Call
Hercules Call
Jovian Super VIA 619
Metheus VGA 1104 695
Mylex Call

Anthem/Novell
NE-2000 w/o cable 152

NEC Graph Eng-16 612
Number Nine Call
Orchid 1280-1mb 338
Plus HC40 572
Renaissance GRX Call
SDC Series 400 550
STB Pwrgrph 256K 121
Trident 1MB 95
Vermont Cobra/2 924

TAPE DRIVES

Alloy Iomega
Archive Irwin
Colorado Maynard
Core Int Mountain
Everex Tecmar
Wangtek
Call For Prices

MULTIPLEXERS

Mux 900 Series-4 Chan 755
Mux 900 Series-8 Chan 925
Mux 1600 Series-8 Chan Call
Mux 1600 Series-16 Chan Save
Mux w/9.6 Intrl Modem 2675

CYRIX CHIPS

83587-16 110
83587-20 123
83587-25 135
83087-16/25 180
83087-33 192
83086-40 215

COMPUTERS

ALR Bus. V 386/33 1658
ALR Bus. V 486/33 1822
ALR Pow. V 486/33 4792
Acer 486/1200 4921
Acer 1100LX 2450
Acer 1100SX 1041
Acer 1120SX 1223
Intel Call
NEC Call
Samsung S3710/20 2297
Samsung S3710/40 2543
Samsung S3710/60 2790
Texas I TM2000 1038
Texas I TM3000/20 2246
Texas I TM3000/30 2332
Texas I TM3000/40 2419
Unisys SAVE
Wyse All Call

DIGITIZERS

Calcomp 12x12-4 305
Hitachi Call
Kurta IS/1 12x12-4 349
Seiko DF-3613 285
Summa Sketch II 290
Summa Sketch II Plus.320
Summa Sketch Pro 512
Wacom Call

MicroG III Call
CALL FOR LARGER SIZES

DISKLESS WORKSTATIONS

Acer 1170/ISA 3387
Samsung PCT286 569
Samsung PCT 386SX 969
Wyse 386SX/16S 1039

SCANNERS

Canon IX30F w/kit 1319

NEW "E Size"
Calcomp Call

Datcopy GS+ w/kit 1343
HOWTEK Call
Ideal Save
MicroTEK 600G 852
MicroTEK 600Z 1344
MicroTEK 1850 2091
Mitsubishi MS200 559
Panasonic RS307U 1058
Panasonic RS505U 793
Panasonic RS506U 1058
Pentax IQ-SCAN w/kit 759
Complete PC Call
Houston Instruments Save
Logitech Call

NETWORK SOFTWARE CALL

PLOTTERS

AMT IntelliPlot 1278
Calcomp 2024 2990
Calcomp 2036 3898
Calcomp 1026m 5724
Calcomp 1044GT 8599
Calcomp 1070 15069
Calcomp 8902 3029
Da Vinci 720 2230
Enter SP600 580
Enter SP-1800 2702
Enter SP-2800 3351
Enter SP-4810 3760
Enter SP-4820 4520
Enter SP-4830 4924
H.I. DMP52 2029
H.I. DMP62 3265
H.I. DMP-161DL 2825
H.I. DMP-162DL 3682
H.I. DMP162R 5055
H.I. Imagemaker 670
H.I. PC695 549
H.P. 7440A 899
H.P. 7475A 1299
H.P. 7550B w/RS232 2919
H.P. 7550B w/Cent 2789
H.P. 7570A 2487
H.P. 7575A 3011
H.P. 7576A 3927
H.P. 7595C-SX 5254
H.P. 7596C-RX 6652
H.P. 7599A 8396
Ioline 3500 2079
Ioline 3700-1 2767
Ioline 3700-8 2902
Ioline 4000-1 3243
Ioline 4000-8 3447
Ioline 5000 5489
Ioline 7200 10229
ArtPro 3500 2529
ArtPro 3700-1 3221
Roland CAMM-1 3089
Roland CAMM-148 8243
Roland DPX-3500 4120
Roland DXY-1100 752
Roland DXY-1200 1027
Roland DXY-1300 1371
Roland GRX-400AR 4120
Sketchmate 479

CAD Software

CADKEY Light 365
DATA CAD 128 365

CD-ROMS

Hitachi CDR3600PC 503
Hitachi CD1700PC 618
NEC CDR-36 528
NEC CDR-73 726
NEC CDR-83 660
Sony 7201 w/kit 589
Sony 535 w/Kit 405
Toshiba 3301-E 552
Toshiba 3101-I 552

PRESENTATION MONITORS

Mitsubishi 33" 3495
Mitsubishi 37" 5375

MONITORS/ TERMINALS

Acer Call
Addis Call
Amazing Call
Amdek 738+ 451
CTX Call
Goldstar 1460+ 327
Goldstar 1620+ 750
Hitachi 20AS 1829
Hitachi 2085M 1815
IBM 3151-310 479
Idek 5217 Call
Link MC-2W/KB 317
Link MC-5W/KB 281
Link-MC-6 w/o KB 355
Magnovox 9032 259
Mitsubishi 14 495
Mitsubishi 1429C 403
Mitsubishi 16L 979
Mitsubishi 20L 1879
Nanao 9070U 1022
Nanao 9080I 1150
Nanao 9400 2673
Nanao 9500 1922
Nanao 560I Call
NEC 2A 399
NEC 3D-S 583
NEC 4D-S 1024
NEC 5D 2298
NEC 4FG 800
NEC 5FG 1422
NEC 6FG 3110
Seiko 1440 491
Seiko 2050 1949
Sigma Designs Call
Sony 1302 583
Sony 1304 643
Sony 1936 2628
Sony 1604S 1089
Taxan Call
Televideo 955 483
Televideo 965 W/KB 377
Toshiba Call
Wyse 30+W/KB 278
Wyse 50W/KB 355
Wyse 60 W/KB 389
Wyse X5 W/KB 1342
Wyse 150W/KB 366
Wyse 160W/KB 449
Wyse 185W/KB 355
Wyse 370 900
Wyse 670 453

PRINTERS

Alps Save
Canon BJ10EX 349
Canon BJ300 450
Canon BJ330E 610
Canon LBP-8 Plus 1521
Canon LBP-4 Plus 911
Citizen GSX-140 289
Citizen 200GX 159
C.Itoh C-5000 1428
Data Products Save
Diconix 150+ 349
Fujitsu DL3600 605
Fujitsu DL5600 1207
GENICOM 4440XT 5852
GENICOM 3820 1678
GENICOM 4410 4648
H.P. PaintJet 682
H.P. PaintJet XL 1711
Mitsubishi G370 3420
Mitsubishi G500 3239
Mitsubishi G650 4179
Mitsubishi S340 8633
Okidata 182Turbo 229
Okidata 320 321
Okidata 321 449
Okidata 390+ 449
Okidata 391+ 618
Okidata 393+ 984
Okidata 393C 1044
Okidata 400 658
Okidata 400S 658
Okidata 800 978
Okidata 820 1304
Okidata 840 (PS) 1695
OTC 850XL 1389
QMS Call
Qume Express Laser 2290
Qume Crystal Print II 1892
Seiko Smart Label 171
Texas I. PS17 1273
Texas I. PS35 1589
Texas I. ML PS17XL 2547
Texas I. ML PS35XL 2864

UNISYS \$4500
30 PPM LASER

MODEMS

ATI 2400E 169
Everex Call
Hayes Smart 2400 358
Megahertz/Laptops Call
Multitech 224BA Call
Multitech 932EAB Call
Multitech 932EA Call
Telebit T-1000E 546
Telebit T-2500E 789
Touchbase Systems Call
UDS Call
USR HST DUAL 880

NEW PRODUCTS

Fax Pump 755
RoboFAX 2525

Phones Are Open Mon-Fri: 7 am -5 pm Mailing Address: Compu\$ave - 4209 S. 37th Street, Dept. B'2, Phoenix, AZ 85040. Prices reflect U.S. currency and are subject to change without notice. We do not guarantee compatibility. DOA's are replaced or repaired. Any return requires a RMA#. 15% Restocking charge on returns. Our service dept. number is (602) 437-8298. All products carry manufacturer's warranty only. We do not honor rebates, extended guarantees or promotional programs. Mastercard and VISA are accepted. International orders add 5%. Please call or FAX before ordering.

Workstations

External SCSI Drives

286/386/486, Macintosh, Silicon Graphics, Sun,
IBM RS6000, VAX, NeXT, HP/Apollo....

Half Shell size 1.4"x5.5"x7.5" weight 2.5 lb
Hard Drives 40MB to 200MB

Hermit Crab size 2.8"x5.5"x7.5" weight 4 lb
with additional shock mount
Hard Drives 40MB to 200MB

A-Hive Jr size 2.2"x7.1"x7.1" weight 4 lb
Hard Drives 40MB to 1GB
Tape Drives 50MB to 8GB
Floppy Drives 720K to 20MB

A-Hive from size 4.3"x9.6"x9.9" weight 11 lb
Hard Drives 40MB to 3.4GB
Cartridge Drives 44MB to 88MB
Tape Drives 50MB to 8GB
Optical Drives 120MB to 1GB

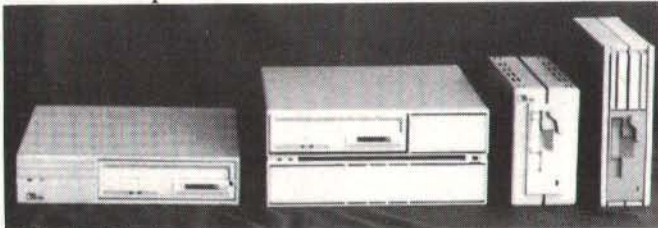

Tulin Technology Tel: 408-432-9057
2156H O'Toole Ave., San Jose, CA 95131 Fax: 408-943-0782

i-Com



CALL USA BY MODEM FOR ONLY
\$12 PER HOUR!!

- Through i-Com you can call any online system in the USA, incl. CompuServe, BIX, Delphi, MCI, Rusty'n'Edi, Channel 1, Eagle's Nest, etc. ...
- ... and company associates, friends, and others.

i-Com has direct access from:

**Austria, Belgium, Denmark, France, Germany, Italy,
Netherlands, Sweden, Switzerland, UK**
Soon also in **Finland, Norway, Spain.**

SEE OUR DEMO SHOW FOR MORE INFO ...

- Call +32 2215 8785 by modem to see our Demo Show.
- Or fax +32 2215 8999 or call (voice) +32 2215 7130 for more information.

Now in JAPAN Modem 03 3708-5540,
Voice 03 3707-6920,
Fax 03 3707-5681

i-Com also operates its own BBS where you can get share-ware programs/files, play games, chat, use E-mail and SIGs at your own leisure.

i-Com, 4 Rue de Genève B33, 1140 Brussels, Belgium

NEW!

Bridge Between Windows and DOS

VIP Cockpit is a Windows and DOS menu and system management shell that lets you switch back and forth between Windows and DOS with a mouse-click or a simple keystroke. The package, which is available from Guildsoft, also includes a set of system management tools that are accessible from the main menu screen.

During installation, VIP Cockpit scans your hard disk and automatically builds a menu system that is based on the programs it recognizes as being available on your PC. This automatically created menu structure is editable with up to nine levels. The VIP Cockpit menu editor's tree structure allows you to view the layout of your menu structure. By pruning and grafting, you can rearrange the structure and easily add new product groups or applications to the menu.

You can personalize VIP Cockpit's interface by selecting the required format and color scheme. The package lets you select icons, push buttons, dialog boxes, folders, or text to give the menus the look and feel you want.

The system management tools are all accessible from the main menu screen. They include the Security module, Statistics module, E-mail module, Project module, Whereabouts module, Virus Detection module, and

Controller module. The Security module lets you set up access to menu options, applications, and DOS. A mouse and a keyboard-locking facility with an optional screen saver are also available.

With the Statistics module, you can see system information, such as available free memory and disk space. The E-mail module lets you send and receive E-mail messages from the Cockpit DOS or Windows menus. You can send messages to an individual or to a group across an internal company network or to users on a stand-alone machine. With the Project Control module, you can set up special projects and track computer usage. The Whereabouts module lets you leave messages on your screen letting people know where you are and when you will be back. You activate the Virus Detection module to automatically scan applications for new viruses, and you use the Controller module to set up passwords, user levels, menu options, and print records.

VIP Cockpit runs on IBM PCs, ATs, and PS/2s with a Microsoft-compatible mouse, DOS 3.0, and 256 KB of RAM (the company recommends 640 KB) or Windows 3.0 and 640 KB of RAM (the company recommends 1 MB).

Price: £69.95.
Contact: GuildSoft Ltd., The Computer Complex, City Business Park, Stoke, Plymouth PL3 4BB, U.K., 44-752-606200; fax 44-752-606174.

Circle 1359 on Inquiry Card.

If you would like your new product considered for publication in the international section of BYTE, send press releases to BYTE, Attention: Martha Hicks, One Phoenix Mill Lane, Peterborough, NH 03458, U.S.A., (603) 924-2638, fax (603) 924-2550; or Andy Redfern, BYTE/McGraw-Hill, Wimbledon Bridge House, One Hartfield Rd., Wimbledon, London SW19 3RU, U.K., 44-81-545-6271, fax 44-81-540-3833. All press releases must contain price information, address, and telephone number.

POWER STATION!

THE LEO 486SX NOTEBOOK: POWER PLUS UPGRADABILITY

The LEO 486SX Notebook:
the most powerful and versatile computer
on the market.

- 20 or 25 MHz 80486SX CPU
- 1MB to 16MB of on-board RAM
- Removable 20/40/60/80MB hard disk.
(120MB available soon!)
- VGA LCD with 16 gray scales
- Internal 1.44MB FDD
- 80/81-key keyboard
- 2 s, 1 p, external CRT/kbd interfaces
- 100-pin slot for expansion box, giving
3 16-bit slots
- Detachable/rechargeable Ni-Cad battery,
giving at least 2 hrs operation
- 11.4" x 11" x 1.9" (290 x 280 x 49 mm)
- 6.38 lbs (2.9 kgs), inc. HDD and battery



The LEO 486SX Notebook:
A New Standard In Notebook
Computing



AT-Bus Expansion Box



Removable HDD



First International Computer, Inc.

6F, FORMOSA PLASTICS REAR BUILDING
201, TUNG HWA NORTH ROAD TAIPEI, TAIWAN
Tel: 886-2-7174500 Fax: 886-2-7182782 Telex: 23056 CHARLENE
FIC EUROPE BV Tel: 31-73-134640 Fax: 31-73-131945
FIC USA Tel: 1-510-4757885 Fax: 1-510-4755333
FIC SPAIN Tel: 34-91-307-0343 Fax: 34-91-307-1463



INTERNATIONAL DISTRIBUTORS:

Europe: FRANCE: A.E.E. Tel: (01) 46720909 Fax: (01) 46704901 GERMANY: K&S Tel: (04952) 8080 Fax: (04952) 8860 Macrotron: Tel: (89) 423745 Fax: (89) 422863 Skodex Tel: (851) 82016 Fax: (851) 81078 GREECE: CH. THEODOSSIS SA Tel: (01) 9580109 Fax: (01) 9596015 SWEDEN: Jet Data Tel: (08) 7533145 Fax: (08) 7533820 SWITZERLAND: EIL Tel: (01) 8210440 Fax: (01) 8213632 UNITED KINGDOM: Centerprise Tel: (0256) 843174 Fax: (0256) 463754 CZECHOSLOVAKIA: Skodex Tel: (2) 254861 Fax: (2) 250064 NORWAY: Exess Norge A/S Tel: (47) 4883100 Fax: (47) 4883333
Asia/Pacific: AUSTRALIA: Skodex Tel: (02) 8913599 Fax: (02) 8912058 INDONESIA: P.T. Intikom Berlian Mustika Tel: (021) 5203501 Fax: (021) 5203504 JORDAN: Al Raed Tel: (06) 664343 Fax: (06) 655092 OMAN: Oman Computer Services Tel: (968) 698352 Fax: (968) 698356 PAKISTAN: Leo Computers (Pvt) Ltd. Tel/Fax: (051) 564737 Telex: 54478 SAUDI ARABIA: RBM COMPUTER SYSTEM Tel: (01) 4772727 Fax: (01) 4772225 THAILAND: Summil Tel: (02) 2380895 Fax: (02) 2367392 LEBANON: Int'l Computer Center Fax: (357) 9514262

* The Intel Inside logo is a trademark of Intel Corporation. All other names used herein are registered trademarks of their respective owners.

Circle 453 on Inquiry Card (RESELLERS: 454).



UNIAIR

BUS SERVICE

ISA or EISA, UNIAIR has the total solution

Both system assemblers and experienced reviewers agree that quality systems require quality components. Worldwide, PC companies rely on UNIAIR to deliver leading-edge motherboards and graphics adapters at competitive prices. Total solutions for both ISA and EISA systems with compatibility and reliability guaranteed by an extensive testing program.

Take UNIAIR's latest EISA motherboard for example. Baby AT-sized, the 486ES supports 50MHz, 33MHz and 25MHz CPUs. Onboard memory can be expanded to 32MB, and a Weitek socket is available. With the 50MHz CPU, this board delivers an astonishing 21.4 Powermeter MIPS. For graphics engines, UNIAIR is shipping the new EISA AVIEW2E Super VGA card, which outperforms XGA graphics accelerators by as much as 40%. Boards like these, and their ISA equivalents, are the key components which allow system assemblers to deliver the price/performance ratio that the market demands.

Your systems need flexibility of design, they need easy upgradability, they need high-performance and built-in reliability, and they need to win the approval of distinguished reviewers. UNIAIR provides the total solution for your requirements.

**Distributor
and
OEM Welcome**

UNIAIR

Manufacturer & Exporter
UNITED HITECH CORPORATION
7F-1, No. 1 Wuchuan 1 Rd.,
Hsinchung City, Taipei-hsien, Taiwan, R.O.C.
Tel: 886-2-299-3125/30 Fax: 886-2-299-3210

In the U.S., please contact:
ADVANCED INTEGRATION RESEARCH, INC.
2188 DEL FRANCO STREET SAN JOSE, CA 95131
Tel: (408) 428-0800 Fax: (408) 428-0950

Distributors:
SINGAPORE:
PET COMPUTER SERVICE (S) PTE LTD.
Tel: (65) 2967222 Fax: (65) 2961293, 294994
WEALSOFT COMPUTER SERVICES PTE. LTD.
Tel: (65) 2988298 Fax: (65) 2972218

INDONESIA:
P.T. BHINNEKA DATA PROSES
Tel: (62) 021-4899835 Fax: (62) 021-6399061



Computex Taipei '92
Booth No: A437, A439

GERMANY:
STUTT GART:
NP COMPUTER SYSTEME GmbH
Tel: (49)0711-629010 Fax: (49)0711-6210030

U.K.:
GETIN
Tel: (44) 0923-233737/239705
Fax: (44) 0923-250139

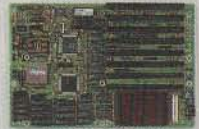
Circle 448 on Inquiry Card.

386UF-33/40



486ES-33/50



486US-SX-20-DX-25/33/50



486BP ISA CPU CARD



AVIEW 2E S3 EISA VGA



EISA SCSI II Controller

486 Local Bus M/B with S3 or
Tseng Lab Local Bus VGA

AVIEW 2 S3 ISA VGA

FINLAND:
TILIGEM KY
Tel: (358)0-490810
Fax: (358) 0-446519

SPAIN BARCELONA:
BX SISTEMES
Tel: (34) 93-5820208
Fax: (34) 93-5820209

Build Yourself a SPARC Clone

With PC clones being so inexpensive, few people would consider building their own. However, SPARC machines still command a premium price—so is it worth it to make a do-it-yourself SPARC clone?

HENRY MCGEOUGH

While I was walking around a PC show, something caught my eye—a large, full-color, three-dimensional fish swimming around in a demonstration on the screen of a Sun IPX workstation. This looked like what I'd been looking for—fast, colorful multi-tasking—and I wanted one. The price? Well, as I had to ask, I obviously couldn't afford it.

The salesperson then informed me that I could build one with just seven chips. That didn't sound too difficult, so I began thinking about just how hard it would be to build a SPARC clone myself. As a software developer with hardware connections, I decided to find out the facts and see if a do-it-yourself SPARC clone was a practical possibility. Photo 1 shows a machine that cost me just under £6000 to build. This article describes how I put it together.

The Rising of the Sun

In 1980 at Stanford University, a student named Andy Bechtolsheim built his own high-powered workstation using off-the-shelf parts. The name *Sun* came from this first Stanford University Network Workstation. Bechtolsheim then formed Sun Microsystems with Bill Joy, who was working on improvements to the networking features of Unix. The Sun-1 workstation was thus born. It used a 68000 chip—a nice, clean, 32-bit CPU with 1 or 2 MB of RAM—and included a mouse, a monochrome monitor, and an Ethernet adapter.

The Sun-2 followed in 1984, with a 68010 CPU. In 1986, the Sun-3 was introduced with 68020 and 68030 CPUs. Meanwhile, Sun was working on its own RISC chip—the SPARC. Its first chip, the 16.67-MHz MB86900, was made by Fujitsu in April 1986 and appeared in the Sun-4 workstation family.

In 1987, Sun announced that the open SPARC architecture would be licensed to multiple vendors. The Sparcstation 1 was released in 1989, and the seeds of the Sun-clone and Sun-compatible markets were planted. (For further information on the organization that controls the future of the SPARC architecture, see the text box "SPARC International" on page 100IS-44.)

A subtle distinction exists between a Sun clone and a Sun compatible. A Sun clone should run SunOS or Solaris

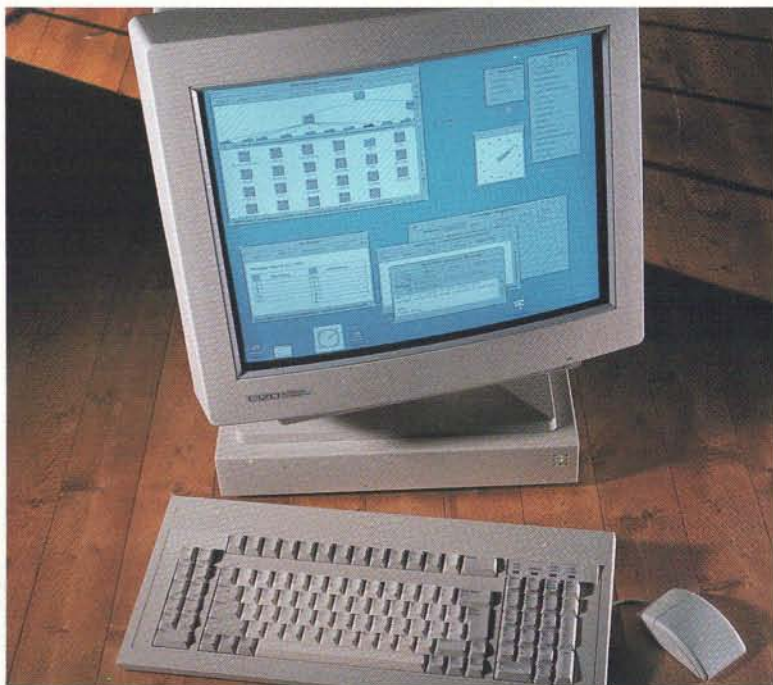

Photo 1: The combination of the Eizo monitor, the Trimm case, the Key Tronic keyboard, and the Logitech mouse makes a good-looking machine. The machine pictured, with the Tritec SPARC-2 board used internally, costs less than £6000 to build.

SPARC International

To control the future definition and evolution of the SPARC microprocessor architecture, SPARC International was created as a nonprofit organization, with testing facilities for binary SPARC compliance tests. The SPARC Compliant SCD 1.0 logo indicates that software or hardware has been passed through the SCD (SPARC Compliance Definitions) testing suites. When SunOS migrates to Solaris 2.0 and becomes compatible with Unix System V release 4.0, a new set of tests will be introduced for SCD 2.0.

Membership in SPARC International is open to all and is divided into four

levels. *Executive* members have full voting rights, can nominate a board member, and can serve on the architecture committee. *Associate* members can vote for two board members and all but the architecture committee, and they have free access to publications. *ISV/VAR* members can attend committee meetings and vote for one board member and have access to all publications. Members of this grade are supplied with software to test whether their software complies with the SCD 1.0 standard. *Affiliate* members can serve on committees without voting and have access to all publications.

intending to work with Unix on a PC.

I made a list of five monitors: the 16-inch Eizo 560tpi, a 16-inch Panasonic, a 20-inch Philips, a 21-inch Hitachi (in monochrome or color), and the new 17-inch NEC 5FG. All these monitors work at the required resolution, although Hitachi is the only supplier that is also able to offer cables to connect to Sun compatibles.

The floppy drive can be a 3½-inch 2.88-MB unit or a 3½-inch 1.44-MB unit. I chose the Sony MP-F17W-5PF, as recommended in LSI Logic's SparKit manual. This drive lets you use Insignia Solutions' SoftPC and read IBM PC floppy disks.

The hard drive can be any 100- to 400-MB SCSI 3½-inch half-height model, although 100 MB would be a squeeze. The trick is getting the operating system installed onto the hard drive. The best option is to have it preinstalled by the clone vendor. The next-best option is to get it from SunSoft, who can supply a bootable Solaris CD-ROM containing the complete operating-system software, which you can easily copy to your hard drive. Alternatively, either Solaris or SunOS 4.1 can be supplied on a tape cartridge.

I was going to use a mini-tower PC case, complete with a power supply and an IBM AT keyboard. Then I found out that the keyboard needed to be a Sun-4 type because the IBM AT-style keyboard wouldn't work with a SPARC clone. It proved difficult to track down a Sun-4-type keyboard until I got the LSI SparKit manual, as well as a full parts list for a Sun clone. LSI also helpfully includes a list of suppliers for everything else that you might need.

Looking through the list of suppliers, I discovered that Key Tronic can supply keyboards and Logitech can supply suitable mice. Logitech offers two types of mice: One is optical, with a reflective mouse pad, and the other is optomechanical, with a rolling ball. Both mice have three buttons, which is required for a Sun machine.

Looking further down the list, I discovered that Trimm Industries can supply SPARC "pizza-box" cases and power supplies, and it also has a branch office in the U.K. that can supply these products to European customers. So now I had all the pieces I needed to build a SPARC clone, except for the motherboard.

Motherboards and SPARC Chip Sets

The next step was finding a SPARC chip set and deciding if it would be worth designing my own PCB (printed circuit

straight out of the box. This keeps down the cost of software development for a clone builder but means that a clone must be totally compatible in every way.

A Sun compatible needs a port of SunOS, either from Interactive Systems or from the chip-set vendor, who may have already gotten Interactive Systems to do the port. Depending on how much needs to be done (a driver or a major re-

write), the cost could be as much as \$350,000. This is a good reason for choosing your chip set wisely. If there is a binary port available for your chosen chip set, it will simplify the task of getting your board up and running. SunOS binaries and manuals can cost from \$300 to \$600 per unit to license.

The Making of a Clone

So what parts would an OEM clone builder need for putting together a Sun clone? There are several options: Some depend on how many clones you want to make; others depend on what you want to make. The breakdown of components that you'll need is shown in the table.

You can source a motherboard ready-built as a complete kit or as parts from multiple suppliers. When you come right down to it, there is no reason why a Sun clone could not be sold in parts in the same way a PC is. A clone builder might provide two or three motherboards, a hard drive with SunOS, manuals, a selection of cases, a keyboard, a mouse, and an offer to supply popular multisync monitors that are known to work with Sun clones. You could then mix and match components in the same way you do now with PCs, or you could just buy the whole package already assembled.

My original idea was to see if it is possible to build a SPARC clone for the price of an IBM-compatible 486 PC by using many of the same parts (e.g., case, power supply, and keyboard) that are commonly available for PCs. The monitor needed to be able to handle a screen resolution of 1152 by 900 pixels—a feature you might well opt for if you were

BYTE ACTION SUMMARY

The availability of SPARC motherboards provides the adventurous with an opportunity to beat high workstation prices by building their own machines. The choice of components is wide, with many manufacturers providing chip sets and motherboards. Even good-looking cases, keyboards, and mice can be bought at minimal cost. By assembling pieces from around the world, you can build a SPARC-2 clone for under £6000.

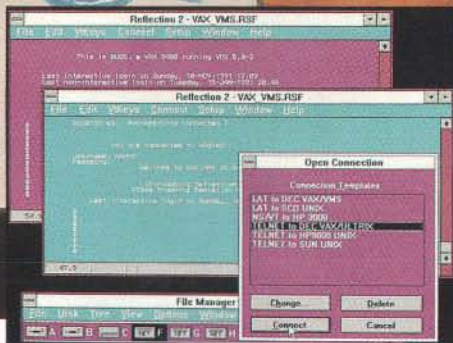
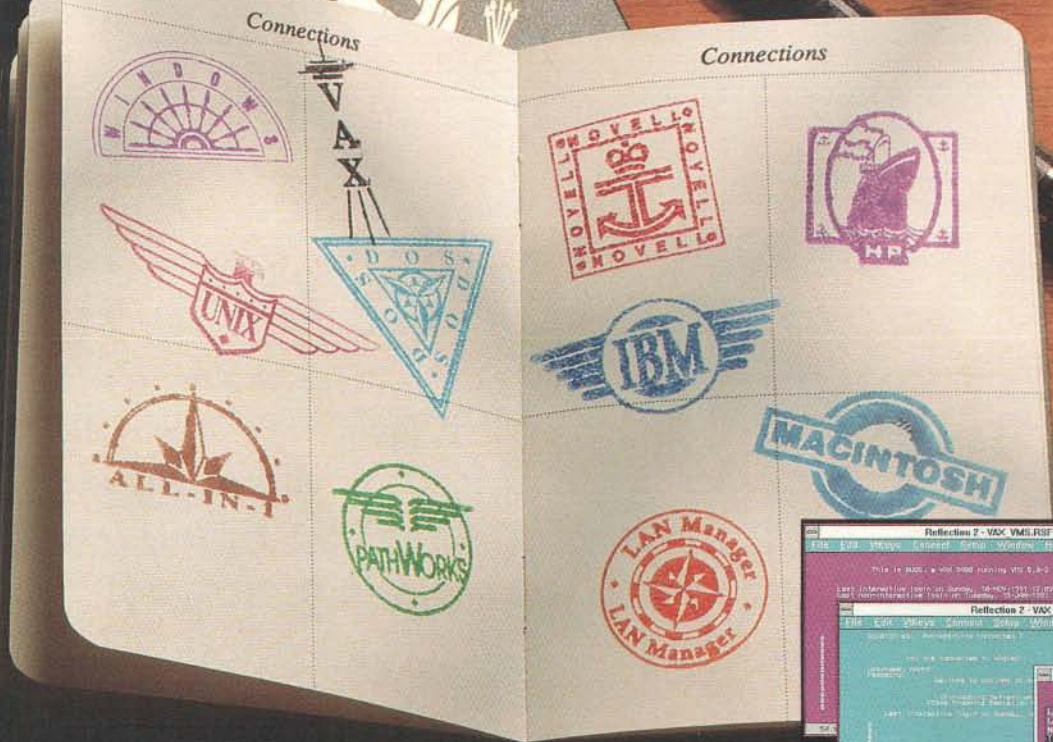

Reflection: your passport to multivendor connectivity.

The computing world is changing. Now, Reflection® and the Reflection Network Series™ software extend the reach of your desktop computers in multivendor environments.

Together, Reflection and the Reflection Network Series link all your systems. Reflection provides the user interface, offering the most precise VT and HP text and graphics terminal emulators for DOS, Macintosh, and MS-Windows. Reflection also delivers fast file transfer, keyboard mapping, and a powerful command language to automate the most complex tasks.

Using Reflection with the Reflection Network Series lets you work on host and server applications at the same time. Access is provided to Digital VAX, UNIX, HP, and IBM hosts *concurrently*, along with Novell and other LANs. You can run multiple protocols simultaneously on a single PC, and switch among them without rebooting. Because protocols are loaded only as needed, memory is saved as well. It's the software solution that operates without a lot of additional hardware.

Reflection and the Reflection Network Series—the connectivity choices for a changing world.

ADE/F	(61) 73 32 49
Wick Hill IMX Ltd./GB	(0483) 772280
GFK Hamburg/D	(040) 23 73010
Data Helsinki/SF	(0) 692 6700
Salcom/SF	(0) 804 1789
Computing & Systems Consultants/NL	(040) 434 957
SIS Datenverarbeitung/A	(1) 376316
Siosistem/I	(030) 2421074
Silicon/P	(1) 8151234
Scorpion Systems/E	(3) 485 40 44
Nocom AB/S	(018) 32 1090
Nocom /N	(034) 70494
Bodeind/IS	(1) 612061
CommCare/CH	(01) 730 24 31
Megatec/AUS	(3) 874 3633
Brazil Software/BRA	(21) 240 3143
One to Seven Products/NZ	(9) 3580758
Singapore Computer Systems Pte. Ltd./SIN	441 2688
A-Line Technologies/B	(02) 718 3611
Tempest Europe/DK	(44) 94 89 02
Cybernet Systems/JPN	(03) 3982 3701

REFLECTION
SERIES
SOFTWARE

Walker Richer & Quinn, Inc.

board) motherboard. An already-built SPARC motherboard from a supplier is obviously the easiest route to making a clone. For a more adventurous design, you can mix and match chip sets or add DSP (digital signal processing) and extra communications support. Why not add an Intel 860 coprocessor for graphics, for instance?

The main OEM vendors of motherboards are Opus Systems (not to be confused with the U.K. PC manufacturer

Opus) and LSI Logic, which also produces a kit called the SparKit 25 that comes with all the information you need to build a 20- or 25-MHz SPARC clone. If you take this route, there are few problems. Opus Systems (which can supply SunOS 4.1.1 binaries) designed the board and ported the operating system for LSI Logic, which manufactures the SparKit. LSI also produces many of the chips needed to build a SPARC. The SparKit is a complete kit of parts, PC

gerber tapes, and schematics for producing a motherboard PCB. This is very flexible and allows an OEM to start off small by buying complete motherboards and then later scale up operations by manufacturing its own boards.

LSI has just released the SparKit 40, which updates the previous kit and gives full details on how to build SPARC-2-clone motherboards. As a good example of a finished product from the kit, LSI recommended the ready-built motherboard produced by Tritec Electronic using LSI 40-MHz parts (the L68411 IU [integer unit] and the L68414 FPU). (See photo 1.)

For a more adventurous design, you can mix and match chip sets.

The SPARC Chip Sets

Fujitsu Microelectronics' S-16 chip set uses a 16.67-MHz MB86900 and offers 10-MIPS performance. The S-25 chip set uses an MB86901 IU, which runs at 20 or 25 MHz and gives 12- to 15-MIPS performance. A Weitek 3170 FPU is used to provide floating-point math functions. An MB86920 MMU (memory management unit) offers 4 GB (giga-bytes) of virtual address space and 64 MB of physical address space. The DRAM controller recommended for use with the kit supports the latest 16-MB SIMMs and controls up to 256 MB of RAM. Interactive Systems performed the port of SunOS for this chip set. The Fujitsu MB86930 gives 33 MIPS at 40 MHz, with 136 registers and hardware for integer multiply and divide. It is also designed for use with embedded applications.

The Cypress SPARC chip set from Ross Technology includes integer, floating-point, memory management, and cache functions. The CMOS CY7C601 IU delivers 29 MIPS at 40 MHz and is produced in 25-, 33-, and 40-MHz versions. The matching CY7C602 FPU is made by Weitek. These chips can be used with Tera Microsystems' chip set. The



The Smart-UPS™

by American Power Conversion



Smart-UPS 400 (11/90)

APC Uninterruptible Power Supplies keep more LANs up, running, and reliable than any other brand of UPS. Call for your free power protection handbook and find out why.

APC Europe

4, Rue Ste Claire Deville
ZAC du Mandinet Batiment Espace
Lognes 77447 Marne La Vallee
Cedex 2, France

Phone: 33 (1) 64 62 5900

Fax: 33 (1) 60 17 8029

In US: (800) 800-4APC, Dpt. A2

Advanced features

- Tracks power quality data for analysis (software required)
- Interface for Novell, LAN Manager, LAN Server, Unix, Banyan, etc.
- SmartBoost™ brownout correction
- Full-time multi-stage surge suppression, EMI/RFI filters
- Battery replacement LED, load and voltmeters
- 400 to 2000VA in both 117V and 220/240V models

Unmatched reliability

- 1986, 1990 PC Magazine Editor's Choice
- 1989, 1990 Reseller Management "Best to Sell UPS"
- 1990, 1991 LAN Times, Readers' Choice
- 1989 PC Week, "All Around Reliable Choice"
- 1990 Infoworld, "Value Leader"
- 1990 Systems Integration, Product of the Year
- 1991 Byte Magazine, Best UPS for LANs



Circle 415 on Inquiry Card.

MORE CACHE - LESS CASH

The Most Complete Line of Add-in Memory Boards for HP-Computers



We're strong on Performance

HP 1000 Series E, F

GFK749H-10	1 MB board
GFK749H-20	2 MB board

HP 1000 Series A 400, 600, 700

GFK103X-10	1 MB board
GFK103X-15	1.5 MB board
GFK103X-20	2 MB board
GFK103X-40	4 MB board
GFK103X-60	6 MB board
GFK103X-80	8 MB board

Hood-Connectors

HP 1000 Series A 900, 990

GFK221X-40	4 MB board
GFK221X-80	8 MB board
GFK221X-160	16 MB board
GFK221X-320	32 MB board

Hood-Connectors

HP 3000 Series 6x, 7x

GFK165R-40	4 MB board
------------	------------

HP 3000 Series 9x7

GFK2231A-160	16 MB ECC board
GFK2232A-320	32 MB ECC board
GFK2511A-640	64 MB ECC board
GFK2230U-80	8 MB upgrade
GFK2230U-160	16 MB upgrade
GFK2230U-240	24 MB upgrade

HP 3000 Series 920, 922, 932, 948, 958

GFK1436A-160	16 MB ECC board
GFK1437A-320	32 MB ECC board
GFK1404U-80	8 MB upgrade
GFK1404U-160	16 MB upgrade
GFK1404U-240	24 MB upgrade

HP 3000 Series 925, 935, 949

GFK1010A-80	8 MB ECC board
GFK1037R-160	16 MB ECC board
GFK1010U-80	8 MB upgrade

HP 3000 Series 950, 955, 960, 980

GFK1104A-160	16 MB ECC board
GFK1152A-640	64 MB ECC board

HP 9000 Series 200, 310, 320

GFK257A-05	512 KB board
GFK257A-10	1 MB board
GFK257A-20	2 MB board
GFK257A-40	4 MB board
GFK257U-05	512 KB upgrade
GFK257U-20	2 MB upgrade

HP 9000 Series 318, 330

GFK258A-40	4 MB daughterboard
GFK258A-80	8 MB daughterboard
GFK258AU-40	4 MB upgrade

HP 9000 Series 362

GFK2320-10	1 MB module
GFK2321-20	2 MB module
GFK2322-40	4 MB module
GFK2323-80	8 MB module

HP 9000 Series 382

GFK2200A-40	4 MB ECC module
GFK2201A-80	8 MB ECC module
GFK2202A-160	16 MB ECC module

HP 9000 Series 400

GFK229A-40	4 MB ECC module
GFK229B-80	8 MB ECC module
GFK229D-160	16 MB ECC module
GFK229E-320	32 MB ECC module
GFK229AU-40	4 MB upgrade
GFK229DU-160	16 MB upgrade

HP 9000 Series 425 e

GFK2200A-40	4 MB ECC module
GFK2201A-80	8 MB ECC module
GFK2202A-160	16 MB ECC module

HP 9000 Series 705, 710

GFK2216A-80	8 MB ECC module
GFK2217A-160	16 MB ECC module
GFK2218A-320	32 MB ECC module

HP 9000 Series 720, 730, 750

GFK1979A-160	16 MB ECC module
GFK1987A-320	32 MB ECC module
GFK2512A-320	32 MB ECC module
GFK2513A-640	64 MB ECC module

HP 9000 Series 8x7

GFK2231A-160	16 MB ECC board
GFK2232A-320	32 MB ECC board
GFK2511A-640	64 MB ECC module
GFK2230U-80	8 MB upgrade
GFK2230U-160	16 MB upgrade
GFK2230U-240	24 MB upgrade

HP 9000 Series 820, 822, 832, 842, 852

GFK1436A-160	16 MB ECC board
GFK1437A-320	32 MB ECC board
GFK1404U-80	8 MB upgrade
GFK1404U-160	16 MB upgrade
GFK1404U-240	24 MB upgrade

HP 9000 Series 825, 835, 845

GFK1010A-80	8 MB ECC board
GFK1037R-160	16 MB ECC board
GFK1010U-80	8 MB upgrade

HP 9000 Series 850, 855, 870

GFK1104A-160	16 MB ECC board
GFK1152A-640	64 MB ECC board

HP 9000 Series 319

GFK266A-40	4 MB daughterboard
GFK266B-80	8 MB daughterboard
GFK266U-40	4 MB upgrade

HP 9000 Series 332

GFK269A-10	1 MB daughterboard
GFK269B-40	4 MB daughterboard
GFK269U-30	4 MB daughterboard (trade in 1 MB)

HP 9000 Series 340

GFK268A-40	4 MB board
------------	------------

HP 9000 Series 345, 375, 380

GFK229A-40	4 MB ECC module
GFK229B-80	8 MB ECC module
GFK229S-160	16 MB ECC module
GFK229E-320	32 MB ECC module
GFK229AU-40	4 MB upgrade
GFK229SU-160	16 MB upgrade

HP 9000 Series 350, 370

GFK258B-40	4 MB daughterboard
GFK258C-120	12 MB daughterboard
GFK258U-80	8 MB upgrade

HP 9000 Series 360

GFK267A-40	4 MB daughterboard
GFK267B-80	8 MB daughterboard
GFK267C-120	12 MB daughterboard
GFK267U-40	4 MB upgrade
GFK267U-80	8 MB upgrade

- 10 years warranty
- Immediate Delivery
- Affordable Prices

GFK HAMBURG · GERMANY

Frankenstraße 29 · 2000 Hamburg 1

Phone (40) 23 73 01-0

Fax (40) 23 17 89

SCSI+IDE Siamese Twins Controller

Longshine LCS-6633F rivals the leading SCSI controller

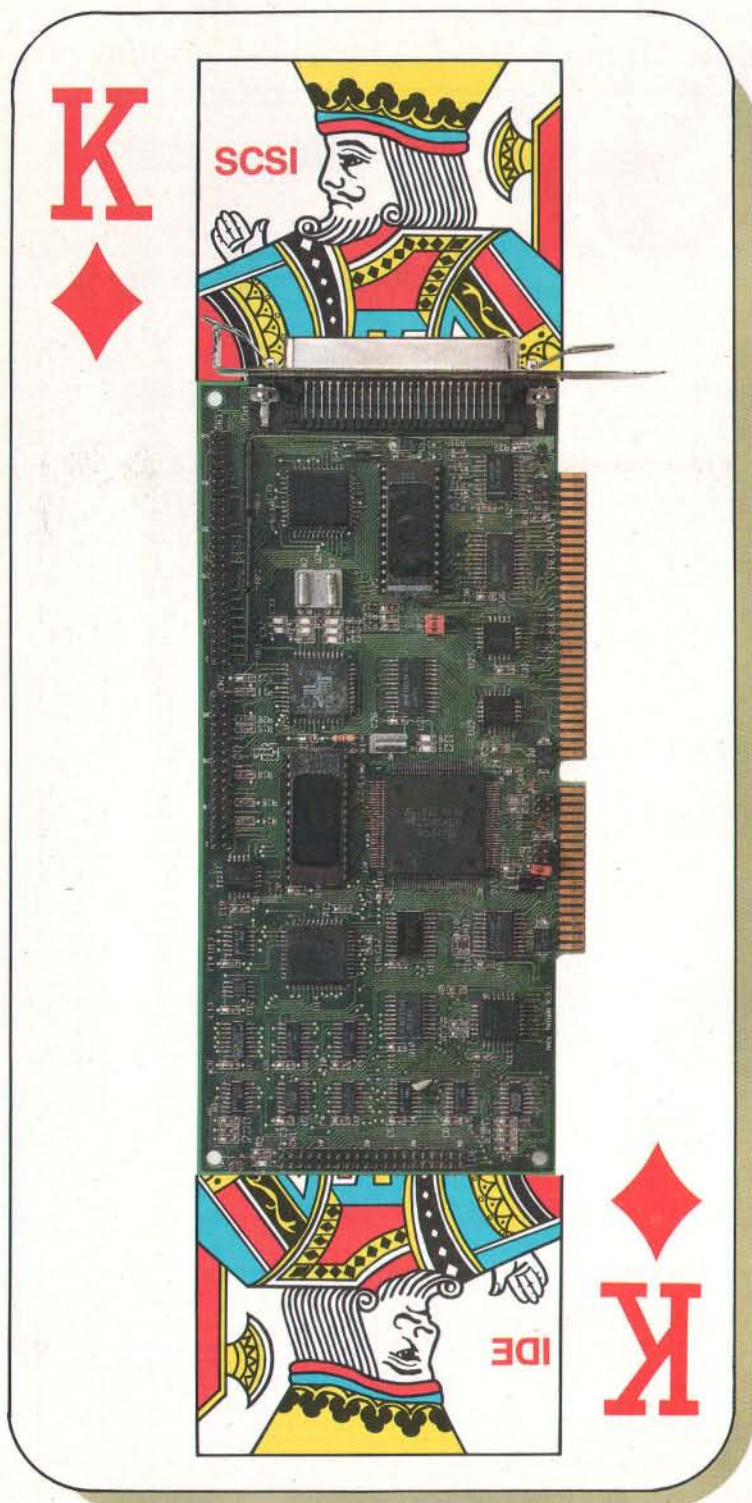

The LCS-6633F is a dual interface controller that combines SCSI and IDE control. Its performance is comparable with the AHA-1542B SCSI controller and its price is highly competitive.

Many sophisticated features can be found on this board. It combines both SCSI and IDE interfaces but provides a standard AT-bus I/O specification. This simplifies hard disk installation since no device drivers are needed for any operating system. In addition, it can support up to seven SCSI drives with a total capacity of 128 Gigabytes.

The LCS-6633F is a high performance intelligent SCSI controller for IBM PC/AT or compatible computers. Optional device drivers for rewritable ODD, CD-ROM, Tape and DAT drives make this card one of the most versatile on the market. Powerful features, reasonable pricing and excellent support make it ideal for file servers, multi-user systems and workstations.

- Controls 7 SCSI devices, 1 or 2 IDE HDD's and 2 FDD's.
- AT task file compatible.
- 2.6 Mbytes/sec. asynchronous transfer rate on the SCSI bus.
- Supports DOS, OS/2, NetWare, Unix and other operating systems.
- User friendly and easy to install.
- Optional drivers for MODD, RHDD, CD-ROM and tape or DAT drives.
- Low cost and high performance.

For more information contact your nearest Longshine distributor or one of our offices.

 **LONGSHINE**

Circle 437 on Inquiry Card (RESELLERS: 438).

Headquarters(Taiwan) / LONGSHINE Electronics Corp. 6F, 245, Sec. 3, Roosevelt Rd., Taipei, Taiwan, R.O.C. Tel: 886-2-3634958.
Fax: 886-2-3626810. USA Office/ Tel: 310-9030899. Fax: 310-9442201. Hong Kong Office/ Tel: 852-0-4206186. Fax: 852-0-4205252.
Germany Office/ Tel: 49-4102-49220. Fax: 49-4102-40109. UK Office/ Tel: 44-923249355. Fax: 852-923224595.
Japan Office/ Tel: 81-03-38399719. Fax: 81-03-38399729. Singapore Office : Tel:65-272-3316 Fax :65-272-9570

Trademarks: IBM PC/AT, OS/2: International Business Machines Corp.; NetWare: Novell Inc.; Unix: AT&T Information Systems; AHA-1542B: Adaptec

CY7C604 CMU (cache controller and memory management unit) can be used with the CY7C157 to provide up to 256 KB of fast SRAM (static RAM) cache.

Tera Microsystems' microCore chip set reduces the number of chips you need to build a SPARC-compatible system to just 19 components. There are four main chips, and you need to choose an IU/FPU combination and add support chips, such as the AMD Lance Ethernet controller, the SCSI 53C90 controller, the Zilog 85C30 serial chip, and the FDC 82072 floppy drive controller.

The TM5610 system controller integrates cache, memory management, and

An important consideration on the motherboard is the Open Boot ROM.

main-memory control. It has a direct interface to a Cypress-style IU/FPU and has 4-KB instruction and 4-KB data caches. The TM5620 I/O controller interfaces to the Ethernet and SCSI controllers, and it provides two serial ports for the keyboard and mouse, DMA channels, and monochrome video display with a resolution of up to 1280 by 1024 pixels. These chips, together with support controllers, can be used to provide a low-cost monochrome system.

The TM5630 SBus interface connects Tera's microBus to the standard SBus and provides up to four SBus slots. The last chip in the set is the TM5640 color video controller, which, together with a frame buffer and a BT458 RAM DAC (D/A converter), adds color graphics to the system. Tera can also provide SunOS 4.1.1 binaries, ported by Interactive Systems, for this chip set. In addition, Tera has just announced a new TS-2 chip set with a manufacturing kit to produce a SPARC-2-compatible workstation. Tera and Weitek are teaming up to provide a real challenge to the Sparcstation 2.

Weitek is a familiar name because the 3170 FPU is used with many existing SPARC IUs. The new W8701 integrated SPARC processor combines the IU and

the FPU on the same chip. It is pin-compatible with the CY7601 and can be used as a low-power replacement in existing boards or with the Tera chip set to give a low-chip-count/low-power SPARC system solution. It is available in 25-, 33-, and 40-MHz versions with 136 registers, and it provides 6.15-MFLOPS performance running at a clock rate of 40 MHz.

Weitek's W8720 integrated graphics controller provides accelerated graphics

and is used in the Sun IPX workstation. Weitek supplies an application note with the controller that describes how to build a W8720 SBus card, and a Pixrect library (called the W8720 Sun View Accelerator) is available from Interactive Systems.

The other important consideration on the motherboard is the Open Boot ROM and the use of the SBus. The Open Boot ROM is unique among Unix systems because it uses a token-threaded Forth-83

NEW
HANDTOP Computer

100% Compatible
100% Touch screen
100% Pen based
100% Portable and self contained
But, best of all the DIRECT INPUT mode, Imagine..

HANDTOP Computer is a registered trademark.
 MS, DOS, Windows are registered MICROSOFT trademarks.

HANDTOP
 COMPUTERS
 INTERNATIONAL

REVERT & CHEVALIER

I would like : receive a documentation trading visitation

Name :Fonction : Society :

Address :

Postcode :City : Tel :

Reply coupon returned to : HANDTOP Computers International
 23, ALLÉE DES VENDANGES
 FRANCE-77325 CROISSY BEAUBOURG
 MARNE-LA-VALLÉE CEDEX 02
 Phone : 33 (1) 60.17.70.94 Fax : 33 (1) 60.17.70.77

Photo 2: The Trimm case has enough room to mount two internal 3½-inch hard drives and a 3½-inch floppy drive. The Integrix color SBus display adapter is pictured on the right side.



interpreter as its boot ROM, as a hardware monitor for debugging purposes, and as a configuration program for SBus cards. This software was written by Mitch Bradley of Sun Microsystems, and a description of Forth and the FCode programming language is contained in *The SBus Specification*, available from Sun Microsystems.

Hardware developers interested in designing SBus cards should be sure to obtain Sun's *Open PROM Toolkit User's Guide*, which also provides a programming tutorial. SBus cards contain FCode PROMs that use the SPARC Open Boot ROM to provide position- and processor-independent driver software for the cards.

SunSoft and Interactive Systems

The main supplier of SunOS software for SPARC compatibles is Interactive Systems. It can license the source code and provide ports to new chip sets or write drivers to support new features. Many existing chip-set vendors can also supply compiled binaries that have already been ported by Interactive. The Unix side of Interactive has been acquired by SunSoft (the software side of Sun Microsystems), and SunOS 4.1.1 has been renamed SunSoft Solaris 1.0 (and can be supplied on CD-ROMs). The next release (Solaris 2.0) will move to Unix System V release 4.0 and provide SunOS support for the SPARC RISC and Intel's 386 and 486.

Complications can be introduced by porting SunOS to new hardware. The compatibility between SPARC-type computers depends on the particular operating-system implementation. Applications programmers should only need to work with the operating-system software, not

the hardware. When hardware engineers make changes, operating-system software engineers often need to write more code to make the new hardware compatible. If a software engineer can be "looking over a hardware engineer's shoulder" as he or she makes changes, both money and time can be saved: The software engineer can suggest ways that hardware changes can be implemented with the least number of changes to the operating-system software.

The key is to involve software experts early in the process, as they can spot problems that may increase development time and costs later on. Investment in

software expertise pays for itself: Products get out the door faster, give better performance, and cost less.

Down to Business

Knowing about the chip sets and knowing how to develop the software for your new design is a good start, but do you really want to solder up a PCB? For this article, I chose to use a ready-built motherboard and confine myself to connecting the wires and making it all fit into the case.

After acquiring a full range of the necessary components from various sources, I set about testing them together and actually building my first SPARC clone. All the SPARC motherboards were the same size and used the same method of mounting, with four guideposts and two screws that attach to the back plate. Thus, mounting the motherboard in the case was a simple operation. Trimm supplied me with a sturdy metal SBC-110000 pizza-box case capable of supporting a large and heavy monitor. The power supply in the Trimm case allowed for automatic selection of international voltages between 100 and 240 volts AC and 50 to 60 Hz. I used it at settings of 240 V AC and 50 Hz. The case also had the right 12-way power connector for the motherboards.

In the first system I put together, I used an evaluation motherboard from Tera Microsystems. This board contained the Weitek W8701 IU/FPU chip running at 23 or 40 MHz and three of the Tera microBus support chips. The SBus chip was still under development at the time this article went to press. As the board was supplied without RAM, I installed 16 MB of RAM (using 4-MB by 4-MB by 8-bit Mac SIMMs).

The Tera chip set, being SPARC compatible and not a true SPARC chip set from Sun, required its own special version of SunOS, which was supplied on a Maxtor 200-MB hard drive. The Trimm case had two 3½-inch bays for hard drives plus a bay for a 3½-inch floppy drive that I didn't use (see photo 2). I fastened the hard drive to the bay with seven screws. I used a standard PC power cable to power the drive, although a cable with an angled connector would have been a better fit. A flat 50-way SCSI cable connected the hard drive to the motherboard.

I now had the main components in place, so I closed the sliding metal case and secured it with two screws. I plugged a Key Tronic Sun-4-compatible keyboard into the back of the computer and a Logitech mouse into the side of the keyboard.

YOUR OWN SPARC CLONE

The main components you'll need to build a SPARC clone.

Motherboard

- SPARC CPU integer unit and FPU
- Memory management and cache chip
- I/O chip
- SBus controller chip
- Graphics controller
- Lance Ethernet controller
- SCSI controller
- Serial chip
- Floppy drive controller

200- to 400-MB hard drive with SunOS

3½-inch 1.44-MB floppy drive

Sun-4-compatible keyboard and mouse

Case and power supply

16- or 19-inch monitor with a resolution of 1152 by 900 pixels



Italian Software Agency

dBsee 3.0

The Standard CASE for Clipper

dBsee is a complete Project Development environment.

Allow the interactive definition of prototipe and generate the tailored source code and documentation with a 90% cut of time and costs. Define a standard methodology for application generation, maintenance and documentation of real world business application

Clipper community needs more than a compiler and a lot of tools.

What We suggest is a powerfull and easy to start system for speeding up your software production : dBsee 3.0

THE CASE FOR CLIPPER®

dBsee

- Reducing development time by 90%
- Defining standard development methodology
- Producing source code and documentation
- Supplying maintenance support with reverse engineering
- Easy to learn and use also for non Clipper experienced



Call 0039.323.922066/924239/925356
or Fax 0039.323.925208 for more
information or free demo disk



Italian Software Agency srl
Via Torino, 2 28042 Baveno (NO) ITALY
(0039) 323 - 922066 - 924239 - 925356
FAX (0039) 323 - 925208

More than 150 templates are available in order to generate most sophisticated procedures.

-Reverse Engineering. dBsee uniqueness is possibility of manual intervention on source code by adding lines of program without losing these changes when generation takes place . By activating the reverse engineering process the changes made by adding new command lines will be identified and memorized so that in successive generations their relocation will automatically be carried out.

Circle 473 on Inquiry Card.

dBsee 3.0 support : Summer '87, Clipper 5.01, RTLink, Blinker.

Advantages using dBsee are :

-Possibility of designing the whole application interactively.

-Data entry screen can be designed up to 65.000 rows per 65.000 columns ! A highly sophisticated screen painter allowing the insertion of data entry screen fields coming from different data bases, generation of automatic look-ups, and multi relations directly designing the related object. The methodology adopted is based on the entity relationship model.

-A specific *Lookup Tables Manager* concentrating on a single file all different structured tables for lookups managing automatic data entry and data search.

-**Object programming.** A library of over 100 engineered modules is supplied with dBsee for supporting user interface, video and printer drivers, data entry, recursive windowing, and a long list of utility functions.

-**Template Language.** Thanks to new dBTL (dBsee Template Language), which has same Clipper language syntax, one can generate any kind of source code programs.

Photo 3:
In addition to building the machine with the Tritec board, I built it with the Opus Personal Mainframe and the Tera Microsystems motherboards.

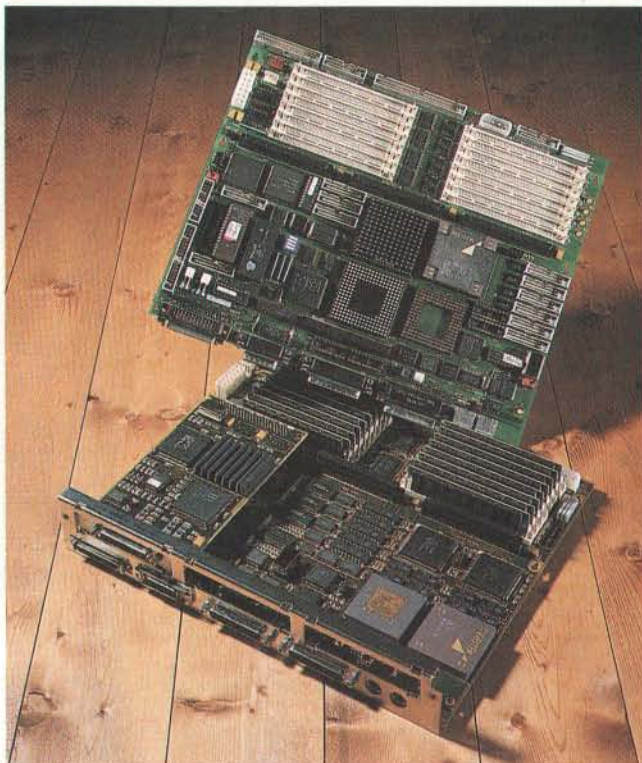

I used a Videk monitor cable with BNC connectors to attach it to a 17-inch NEC 5FG monitor.

Everything was ready; I switched it on. Nothing—the display remained blank. After calling Tera's technical support, I learned that I had used the wrong DRAM SIMMs. The RAM was supposed to be IBM type (9 bits wide) with a parity bit. The BIOS ROM checks the RAM, and if it fails a parity check, it does not bother with initializing the video; hence, no error message on-screen to let you know the RAM has failed. Although it is possible to use 8-bit-wide SIMMs, that would require a recompiled version of the ROM.

Once I changed the RAM to 4 MB by using nine SIMMs, the video initialized and the Tera logo was displayed. A memory test confirmed that I had 16 MB of RAM, and the "OK" prompt of the boot PROM finally greeted me. I was able to check for the hard drive with the command `probe-scsi`, which reported a Maxtor hard drive with a SCSI ID of 3. I then continued to start up Unix with the command `boot disk`. After about 3 minutes, the Unix log-on prompt appeared, and I had a working Sun-compatible workstation.

The next system I created used a full-production SPARC-2-clone motherboard made by Tritec Electronic. This board used the LSI chip set running at 40 MHz

and came supplied with 16 MB of RAM and an Integrix color SBus card. I also used a hard drive with Solaris 1.0 installed, which was kindly supplied by MicroMUSE. Because the Tritec board is a clone, it can use the standard-release version of Solaris or SunOS. Eizo supplied a 19-inch T660iT color monitor, which also worked fine with the Videk monitor lead. The Eizo monitor gave a sharp picture at the standard SPARC resolution of 1152 by 900 pixels at 66 Hz, and it was easy to adjust and center the picture.

The Tritec motherboard was well constructed, with surface-mount components on both sides. The start-up screen showed the system was running a ROM version 2.2 and declared itself to be a Sparcstation 2 with 16 MB of memory and a type-4 keyboard. After the memory check (which can be bypassed by pressing `Ctrl-Alt-F1`), it continued to boot Unix until it reached the log-on prompt.

I also tried to use the Tritec board with the SunOS from Tera Microsystems; the changes to the SunOS for the compatible chip set meant that it could not be used with a clone motherboard. Tritec provided very helpful and efficient hot-line technical support, and I recommend it.

Opus Systems supplied a Personal Mainframe 5000 25-MHz SPARC motherboard, which I used with the hard drive

supplied by MicroMUSE. An LSI L64801 SPARC IU and a Weitek 3172 FPU chip formed the computing heart of the board, with a version 1.0 ROM configured to boot Unix on power-up. System and memory tests proceeded to the now familiar log-on prompt. (See photo 3.)

The Opus board performed without fault and with enough speed for OpenWindows/2. Opus also included a clearly written user's manual and the manual set for Solaris 1.0. It is worth trying out a SPARC-1 clone with the application you wish to run, as you may find the clone to be fast enough for your needs and a worthwhile money saver.

It proved not too difficult to put together a SPARC-clone workstation. The only tool required was a screwdriver. SPARC motherboards and peripherals could be added to the range of available PC motherboards, which should lead to good prices on SPARC clones. An upgrade path would be available to a SPARC-2 motherboard using the same case and keyboard.

The Price Is Right

Proving that it is possible to build a SPARC clone is one thing. But is the machine any less expensive than buying one from Sun, where you would pay a minimum of £11,000 for SPARC-2 performance?

All the following figures are very approximate, as they represent the current price for one of each component, and big discounts are available for volume buyers. The case, keyboard, and mouse would cost you about £500, while the SPARC-2 motherboard from Tritec would cost £2000 with 16 MB of RAM installed. The Eizo monitor pictured is the 20-inch T660iT, which retails for £2400. If you instead use an NEC monitor with a lower specification, you could subtract £1000 from the price. The 207-MB hard drive I used came from MicroMUSE, and with Solaris 1.0 installed, it would cost just over £1000. (This price assumes that the chip set you are using already has a two-user Sun license.)

All this comes to a total of £5000 to £6000. And that's not a bad price for a SPARC-2 clone. ■

Editor's note: As this article was going to press, we learned that Tera Microsystems is ceasing operations.

Henry McGeough is a director of Fire Monkey Ltd., a London-based company that is working on ISDN cards. He can be reached on BIX c/o "editors" or on Internet at hmcg@cix.compulink.co.uk.

We've got the power behind the play

Symbol of Tradition

The Chinese hand puppet Bu Dai Hsi has been a symbol of tradition, as well as entertainment, for centuries. Talented performers use these beautiful puppets to act out legendary tales, but they are only one part of this intricate art form. Behind the scenes are set designers, historians, sound effects and skilled craftsmen that handmake every puppet. Only with the power of their combined talents and dedication has the Bu Dai Hsi performance thrived for hundreds of years.



Tradition of Excellence

Inspired by traditions of excellence like Bu Dai Hsi, AGC developed the Powerplay line of computers to give you the highest quality and most versatile systems available. Versatility means you can match any 286, 386SX, 386DX, 486SX, 486DX, P24 CPU with any Tower, Semi-Tower, Mini-Desktop, Desktop, Slim-Desktop case to give you a system perfectly tailored to your computer needs. But like the Bu Dai Hsi performance, the Powerplay line represents only a small part of AGC's total service. Years of advanced R&D, uncompromising quality control, and experienced technical support unite to guarantee you the best show in town. Powerplay gives you the power to play.



POWERPLAY SERIES™



COMPUTEX '92

Booth No:
D0002 ~ 0006
D0101 ~ 0105
June 5-9, 1992

AGC ELECTRONICS CORPORATION — MAIN OFFICE 16th Floor, Number 109, Min-Sheng East Road, Sec. 3, Taipei, Taiwan, 10446, Republic of China. Telephone: (886)-2-718-1918 (Rep.) Facsimile: (886)-2-718-1808/9 **CACHING TECHNOLOGY CORPORATION — USA OFFICE** 1250 North Lakeview Avenue, Unit Q Anaheim, California 92807 United States of America. Telephone: (714)-777-2818 Facsimile: (714)-777-3608 **AGC ELECTRONIC GmbH — GERMANY OFFICE** Halskestr. 24 W-4030 Ratingen-Tiefenbroich, Germany Telephone: (02102)-49000 Facsimile: (02102)-490021 **AGC ELECTRONIC CORPORATION — S.A. SPAIN OFFICE** Calle General Peron-No. 32 Planta Baja Comercial 28020 Madrid, Spain Telephone: (91)-556-8890 Facsimile: (91)-556-8723

Circle 411 on Inquiry Card (RESELLERS: 412).

FOR MORE INFORMATION

CASES AND POWER SUPPLIES

Integrrix, Inc.
1200 Lawrence Dr.,
Suite 150
Newbury Park, CA 91320
(805) 375-1055
fax: (805) 375-2799
Circle 1138 on Inquiry Card.

Trimm Industries
11949 Sherman Rd.
North Hollywood, CA 91605
(818) 983-1833
fax: (818) 503-0438
Circle 1139 on Inquiry Card.

CHIPS

Advanced Micro Devices, Inc.
901 Thompson Place
P.O. Box 3453
Sunnyvale, CA 94088
(408) 732-2400
fax: (408) 982-6161
Circle 1140 on Inquiry Card.

Fujitsu Microelectronics, Inc.
Advanced Products Division
77 Rio Robles
San Jose, CA 95134
(408) 456-1000
fax: (408) 943-9293
Circle 1141 on Inquiry Card.

LSI Logic Corp.
Microprocessor Group
1551 McCarthy Blvd.
Milpitas, CA 95035
(408) 433-8000
fax: (408) 434-6457
Circle 1142 on Inquiry Card.

Ross Technology, Inc.
5316 Highway 290 W,
Suite 500
Austin, TX 78735
(512) 892-7802
fax: (512) 892-3036
Circle 1143 on Inquiry Card.

Tera Microsystems
5200 Great America Pkwy.,
Suite 250
Santa Clara, CA 95054
(408) 987-5600
fax: (408) 987-5606
Circle 1144 on Inquiry Card.

Weitek Corp.
1060 East Arques Ave.
Sunnyvale, CA 94086
(408) 738-8400
fax: (408) 738-1185
Circle 1145 on Inquiry Card.

HARD DRIVES

Hard drives by Maxtor, Hitachi, Quantum, and Fujitsu are available from the company listed below.

Andataco Computer Peripherals
9550 Waples St.
San Diego, CA 92121
(619) 453-9191
fax: (619) 453-9294
Circle 1390 on Inquiry Card.

KEYBOARDS

Key Tronic Corp.
4424 North Sullivan Rd.
Spokane, WA 99216
(509) 928-8000
fax: (509) 927-5248
Circle 1391 on Inquiry Card.

MONITORS

Eizo
(Nanao USA Corp.
in the U.S.)
Genesis Business Park
Albert Dr.
Sheerwater
Woking
Surrey GU21 5RW
U.K.
44-483-757118
fax: 44-483-757121
Circle 1392 on Inquiry Card.

Hitachi Sales (U.K.) Ltd.
Hitachi House
Station Rd.
Hayes
Middlesex UB3 4DR
U.K.
44-81-8492092
fax: 44-81-5692763
Circle 1393 on Inquiry Card.

NEC
1 Victoria Rd.
London W3 6UL
U.K.
44-81-9938111
fax: 44-81-9927161
Circle 1394 on Inquiry Card.

MOTHERBOARDS

MicroMuse
Unit 1L, Chelsea Reach
78-79 Lots Rd.
London SW10 0RN
U.K.
44-71-3527774
fax: 44-71-3517834
Circle 1395 on Inquiry Card.

Opus Systems
329 North Bernardo Ave.
Mountain View, CA 94043
(415) 960-4040
fax: (415) 960-4001
Circle 1409 on Inquiry Card.

Tritec Electronic GmbH
Robert Kosh Strasse 35
6500 Minz 42
Germany
49-6131-509057
fax: 49-6131-508769
Circle 1410 on Inquiry Card.

MOUSE DEVICES

Logitech, Inc.
6505 Kaiser Dr.
Fremont, CA 94555
(510) 795-8500
fax: (510) 792-8901
Circle 1411 on Inquiry Card.

PC EMULATION

Insignia Solutions Ltd.
Carrington House
Oxford Rd.
High Wycombe
Buckinghamshire HP11 2EG
U.K.
44-494-459426
fax: 44-494-459720
Circle 1412 on Inquiry Card.

SOFTWARE

Interactive Systems Corp.
1901 North Naper Blvd.
Naperville, IL 60563
(708) 505-9100
fax: (708) 505-9133
Circle 1413 on Inquiry Card.

SunSoft, Inc.
(European headquarters)
St. John's Court
Eastern St.
High Wycombe
Buckinghamshire HP11 1JX
U.K.
44-494-472900
fax: 44-494-472383
Circle 1414 on Inquiry Card.

SunSoft, Inc.
(subsidiary of Sun
Microsystems, Inc.)
2550 Garcia Ave.
Mountain View, CA 94043
(415) 960-1300
fax: (415) 969-9131
Circle 1415 on Inquiry Card.

STANDARDS

SPARC International, Inc.
535 Middlefield Rd.,
Suite 210
Menlo Park, CA 94025
(415) 321-8692
fax: (415) 321-8015
Circle 1416 on Inquiry Card.

MATUNG



COMPstation 40



CM20MBD



TNB-500

Thinking of cost effectiveness and price/performance, MIT products should be your first choice. If you come to Computex this June, Tatung is the booth you'd better not miss. Tatung is the company with the longest history in Taiwan's electronic industry, and Tatung also has the most complete product line in the IT industry. So come and see us, and you'll never regret it.

Tatung—the essence of MIT.



Tatung Co.

22 Chung-Shan N. Rd., 3rd. Sec., Taipei, Taiwan, R.O.C.

TEL: 886-2-592-5252 Ext. 2418, 2461, 2423, 2420

FAX: 886-2-598-4509, 886-2-591-5185



COMPUTEX '92
Booth No.: D234, D333

Search and Retrieval Systems

Below are listed, by country, distributors of the U.S. products mentioned in this issue's State of the Art section on Managing Infoglut.



AUSTRALIA

askSam Systems:
Locom Information Systems
61-2-9488020
fax: 61-2-9491036
Circle 1146 on Inquiry Card.

BRS Software Products:
Computer Sciences of
Australia
61-2-9011111
fax: 61-2-9011270
Circle 1148 on Inquiry Card.

Folio Corp.:
Comaxes Corp.
61-2-2996196
fax: 61-2-2902851
Circle 1153 on Inquiry Card.

Johnston & Co.:
ScanText
61-2-2614511
fax: 61-2-2641464
Circle 1163 on Inquiry Card.

On Technology, Inc.:
InfoMagic
61-2-9751044
fax: 61-2-9751350
Circle 1168 on Inquiry Card.

Virginia Systems, Inc.:
Laser Peripherals/Image
Products
61-2-4150344
fax: 61-2-4178680
Circle 1176 on Inquiry Card.

BELGIUM

BRS Software Products:
Prodata S.A./N.V.
32-2-7228711
fax: 32-2-7250628
Circle 1148 on Inquiry Card.

On Technology, Inc.:
PlusProducts N.V.
32-91-855800
fax: 32-91-856016
Circle 1168 on Inquiry Card.

BRAZIL

Folio Corp.:
SOFT
55-21-2648892
fax: 55-21-2649989
Circle 1153 on Inquiry Card.

MicroRetrieval Corp.:
Eletrofix Informatica
55-11-2174169
fax: 55-11-2179272
Circle 1166 on Inquiry Card.

DENMARK

askSam Systems:
ScanTrade By Rame
45-42-804273
fax: 45-42-804673
Circle 1146 on Inquiry Card.

BRS Software Products:
BRS Software Products A/S
45-33-143500
fax: 45-33-144066
Circle 1148 on Inquiry Card.

Folio Corp.:
Kommunedata
45-44-660111
fax: 45-44-660355
Circle 1153 on Inquiry Card.

FRANCE

askSam Systems:
ISE Cegos
33-1-4609276
fax: 33-1-46092800
Circle 1146 on Inquiry Card.

BRS Software Products:
Sinorg
33-1-46623000
fax: 33-1-46620937
Circle 1148 on Inquiry Card.

Folio Corp.:
SAM
33-1-45633192
fax: 33-1-42250676
Circle 1153 on Inquiry Card.

MicroRetrieval Corp.:
Proventec
33-90-562939
fax: 33-90-563507
Circle 1166 on Inquiry Card.

On Technology, Inc.:
ISE Cegos
33-1-46092438
fax: 33-1-46092489
Circle 1168 on Inquiry Card.

GERMANY

askSam Systems:
North American Software
49-89-7909711
fax: 49-89-7900258
Circle 1146 on Inquiry Card.

**WHERE
ON EARTH
CAN YOU CALL US
FOR AS LOW
AS \$20
AN HOUR?**

Now you can connect with BIX, the on-line information service, at a fixed hourly rate from many cities around the world. Compared to packet switching networks, this saves you up to 75% depending on your location. There's

no application process. No character or packet fees. No extra charge for 2400 baud. And you're billed directly by BIX for your phone usage.

Just call the access number nearest you, log on, and the world of BIX is at your fingertips.

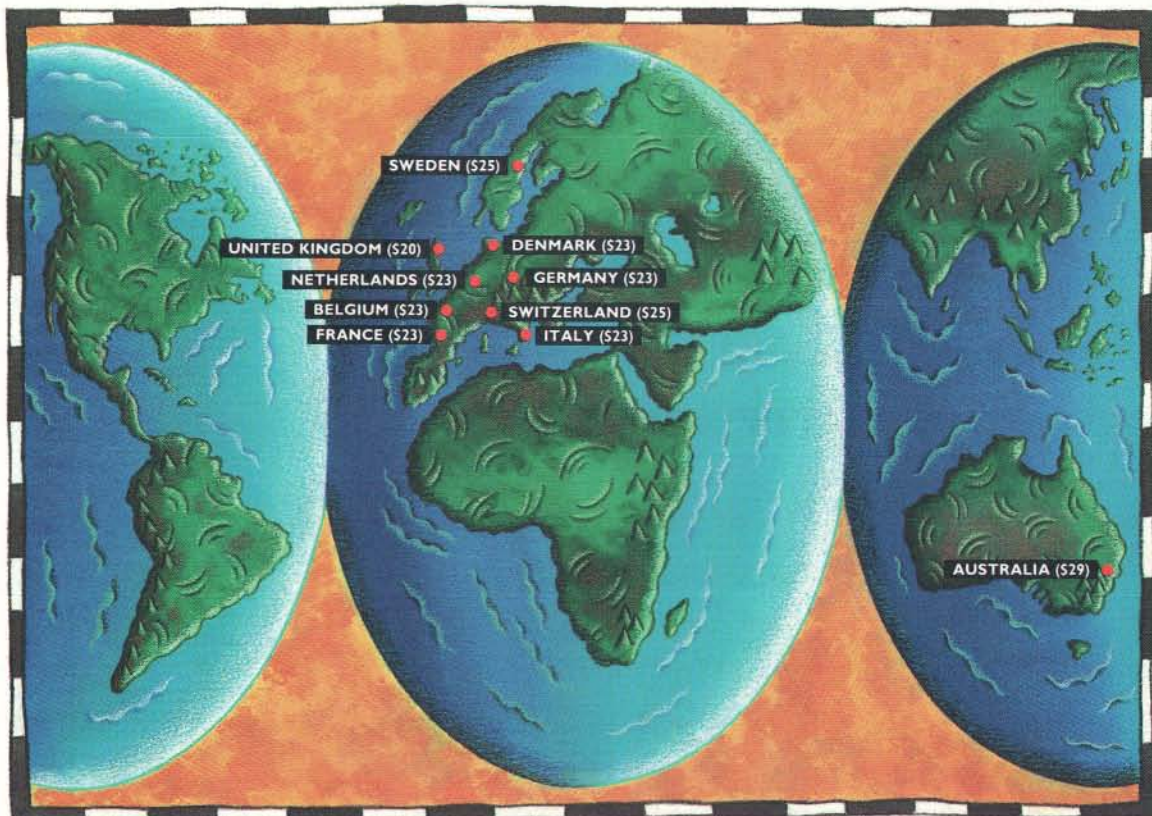

BT Tymnet Access Information: (All amounts are U.S. dollars)

AUSTRALIA (\$29/hr): MELBOURNE (3) 4162146; SYDNEY (2) 290-3400 **BELGIUM** (\$23/hr): BRUSSELS (2) 725-5060 **DENMARK** (\$23/hr): COPENHAGEN 31-18-63-33 **FRANCE** (\$23/hr): PARIS (1) 47719133, (1) 46027003, (1) 46025750, (1) 46025500; LYON (7) 8478144 **ITALY** (\$23/hr): MILANO (2) 66-98-30-04 **NETHERLANDS** (\$23/hr): ALKMAAR (72) 155190; AMSTERDAM (20) 6610094; EINDHOVEN (4902) 45530; THE HAGUE (70) 3475032, (70) 3814641; ROTTERDAM (10) 4532002 **SWEDEN** (\$25/hr): STOCKHOLM (8) 294782 **SWITZERLAND** (\$25/hr): GENEVA (22) 782-9329; ZURICH (1) 730-9673 **UNITED KINGDOM** (\$20/hr): BIRMINGHAM (21) 6326636; BRISTOL (272) 255392; CAMBRIDGE (223) 845860; EDINBURGH (SCOTLAND) (31) 3132172; LEEDS (532) 341838; LONDON Baynard House (71) 4898571, Ealing (81) 5667260 **GERMANY** (\$23/hr): COLOGNE (221) 210196; FRANKFURT (69) 666-8131, (69) 666-4021; MUNICH (89) 350-7682

To learn more about BIX see our other ad elsewhere in this magazine.

THE ONLY SOLUTION TO PENBASE Windows! Unique New 5" x 5" graphics tablet does Windows and a whole lot more.

The new ACECAD ACECAT graphics tablet gives you performance and versatility only dreamed of until now. All at a price that even your entry-level customers can afford.

New ACECAT 5" x 5" graphics tablet will open windows of opportunity for you.

ACECAD's line of digitizers; 12x12, 18x12, 36x48 including ACE-10 is a complete range of tools that will satisfy your present professional clients while helping you capture and serve new ones. Offering quality products with unique features, outstanding value and dedicated support, ACECAD is your best partner today for a more profitable tomorrow. Don't let this window of opportunity close for you. Contact us today!



ACECAD®

ACE CAD ENTERPRISE CO., LTD. R.O.C. ACECAD HOLLAND
TEL:886-2-2186699 TEL:0349536807
FAX:886-2-2182867 FAX:0349534454

ACECAD U. S. A. ACECAD ENTERPRISE GMBH, GERMANY
TEL:1-800-676-4ACE, 1-408-655-1900 TEL:49-6027-8046
FAX:1-408-6551919 FAX:49-6027-8043

LIQUIDATION SALES

- ALL PRODUCTS ARE NEW
- PRODUCTS ARE SUBJECT TO AVAILABLE STOCK
- PRICES ARE FOB USA

PRODUCT	UNIT PRICE	MINIMUM ORDER
IBM SOFTWARE		
MICROSOFT WORKS v.2.0 (OEM VERSION)	55.00	25 UNITS
LOTUS MAGELLAN 2.0 (OEM VERSION)	40.00	25 UNITS
LOTUS WORKS (OEM VERSION)	40.00	25 UNITS
WORDSTAR 2000 R.3.5	65.00	25 UNITS
WORDSTAR v.5.5	65.00	25 UNITS
WORDSTAR EASY EXTRA	25.00	25 UNITS
ASHTON TATE APPLAUSE II	50.00	25 UNITS
XTREEPRO GOLD v.1.43	25.00	100 UNITS
SYMANTEC PC ANYWHERE III	50.00	25 UNITS
DIGITAL RESEARCH DR DOS v.5.0	45.00	100 UNITS
WINDOWS 3.0 (OEM VERSION)	50.00	25 UNITS
MACINTOSH SOFTWARE		
DELTA GRAPH v. 1.5	45.00	25 UNITS
CE QUICK KEYS v. 2.1 (OEM VERSION)	50.00	25 UNITS
CENTRAL POINT MACTOOLS DELUXE v. 1.1	45.00	25 UNITS
HARDWARE & ACCESSORIES		
PRIMAX 3 BUTTON SERIAL MOUSE	20.00	60 UNITS
GENIUS DYNA MOUSE PS/2, PAD, DR. HALO	30.00	25 UNITS
COMPLETE PC FAX/4800 w/FAX IT	90.00	100 UNITS
COMPLETE PC FAX/PORTABLE	205.00	100 UNITS
COMPLETE PC COMMUNICATOR	240.00	100 UNITS
HIGH RESOLUTION MONITORS		
16" 1280 x 1024, .26mm	600.00	100 UNITS
16" 1024 x 768, .31mm	500.00	100 UNITS
20" 1024 x 768, .31mm	800.00	100 UNITS

FOR UP-TO-DATE PRODUCT LIST, PLEASE FAX TODAY

FAX 510-376-0471

AMERICAN BUYING & EXPORTING INC.
1024 COUNTRY CLUB DRIVE, MORAGA, CALIFORNIA 94556
TELEPHONE 510-376-7600

INTERNATIONAL RESOURCE GUIDE

BRS Software Products:
U'Ware Software Technolog
GmbH
49-89-338664
fax: 49-89-339419
Circle 1148 on Inquiry Card.

Folio Corp.:
DATSCHIFF GmbH
49-421-444051
fax: 49-421-491998
Circle 1153 on Inquiry Card.

Johnston & Co.:
Incom und Computer GmbH
49-228-630315
fax: 49-228-656364
Circle 1163 on Inquiry Card.

On Technology, Inc.:
Prisma Handelsgesellschaft
mbH
49-40-658080
fax: 49-40-6524393
Circle 1168 on Inquiry Card.

HONG KONG

SoftSolutions Technology Corp.:
Cybernetics
852-8773386
fax: 852-8770330
Circle 1170 on Inquiry Card.

ITALY

askSam Systems:
Micro Business Italiana
39-2-4390431
fax: 39-2-48193003
Circle 1146 on Inquiry Card.

BRS Software Products:
IPSOA S.p.A.
39-2-824761
fax: 39-2-82476968
Circle 1148 on Inquiry Card.

Folio Corp.:
SIS S.r.L.
39-2-76014823
fax: 39-2-76014823
Circle 1153 on Inquiry Card.

MicroRetrieval Corp.:
Sinopia Informatica S.p.A.
39-51-221294
fax: 39-51-221287
Circle 1166 on Inquiry Card.

JAPAN

SoftSolutions Technology Corp.:
Nihon Libertec Co.
81-33-4818321
fax: 81-33-4818371
Circle 1170 on Inquiry Card.

MEXICO

Folio Corp.:
Logon S.A. de C.V.
52-8-3359020
fax: 52-8-3564869
Circle 1153 on Inquiry Card.

THE NETHERLANDS

BRS Software Products:
BRS Software Products
31-85-579600
fax: 31-85-438636
Circle 1148 on Inquiry Card.

Folio Corp.:
Information Productivity
Solutions
31-30-510307
fax: 31-30-510307
Circle 1153 on Inquiry Card.

SoftSolutions Technology Corp.:
Connectica
31-20-6735866
fax: 31-20-6756459
Circle 1170 on Inquiry Card.

NEW ZEALAND

askSam Systems:
Claughton Marketing
Consultancy Ltd.
64-4-446896
fax: 64-4-446896
Circle 1146 on Inquiry Card.

BRS Software Products:
Paxus Services
64-4-859119
fax: 64-4-843924
Circle 1148 on Inquiry Card.

SoftSolutions Technology Corp.:
GCS Business Systems Ltd.
64-4-4950400
fax: 64-4-4711223
Circle 1170 on Inquiry Card.

Buy with

Confidence



In an effort to make your telephone purchasing a more successful and pleasurable activity, The Microcomputer Marketing Council of the Direct Marketing Association, Inc. offers this advice, "A knowledgeable buyer will be a successful buyer." These are specific facts you should know about the prospective seller before placing an order:

Ask These Important Questions

- How long has the company been in business?
- Does the company offer technical assistance?
- Is there a service facility?
- Are manufacturer's warranties handled through the company?
- Does the seller have formal return and refund policies?
- Is there an additional charge for use of credit cards?
- Are credit card charges held until time of shipment?
- What are shipping costs for items ordered?

Reputable computer dealers will answer all these questions to your satisfaction. Don't settle for less when buying your computer hardware, software, peripherals and supplies.

Purchasing Guidelines

- State as completely and accurately as you can what merchandise you want including brand name, model number, catalog number.
- Establish that the item is in stock and confirm shipping date.
- Confirm that the price is as advertised.
- Obtain an order number and identification of the sales representative.
- Make a record of your order, noting exact price including shipping, date of order, promised shipping date and order number.

If you ever have a problem, remember to deal first with the seller. If you cannot resolve the problem, write to MAIL ORDER ACTION LINE, c/o DMA, 6 E. 43rd St., New York, NY 10017.

This message is brought to you by:

the MICROCOMPUTER
MARKETING COUNCIL
of the Direct Marketing
Association, Inc.
6 E. 43rd St.,
New York, NY 10017

MMCG
MICROCOMPUTER
MARKETING COUNCIL
of the Direct Marketing Association, Inc.

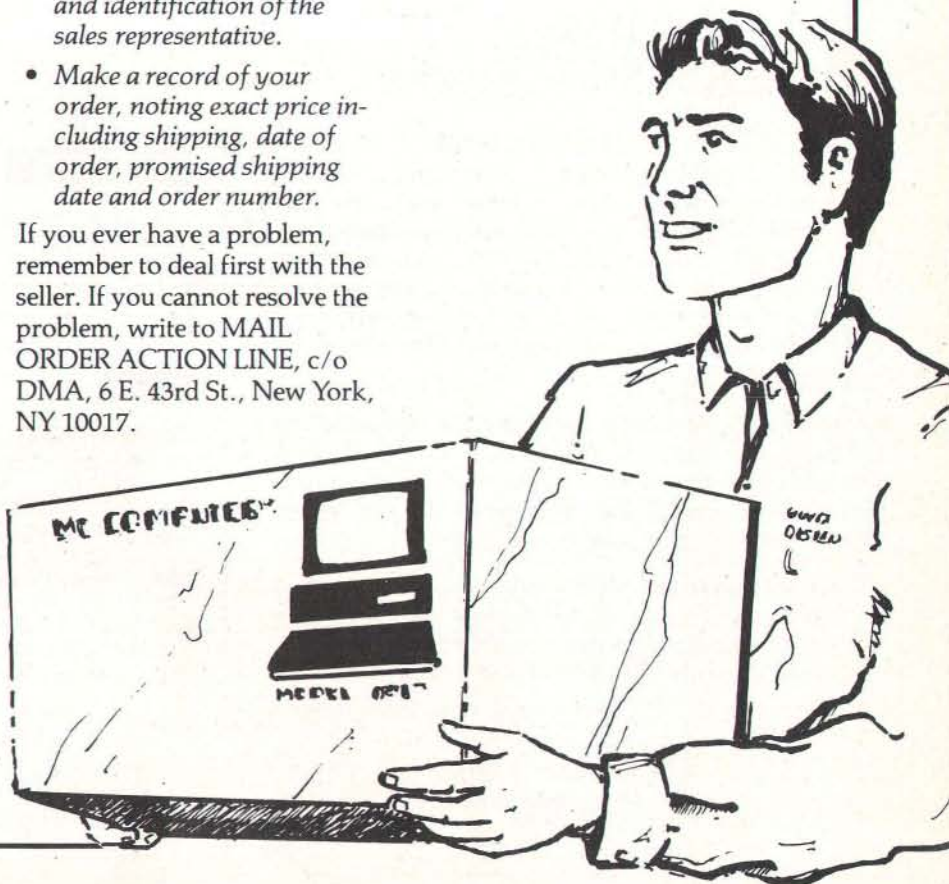

Real-Time Multitasking

for Microsoft C, Borland C, Turbo Pascal

Develop Real-Time Multitasking Applications with RTKernel!

RTKernel is a professional, high-performance, low-cost real-time multitasking kernel. It runs under MS-DOS and supports Microsoft C, Borland C++, Turbo C++, and Turbo Pascal. RTKernel is a library you can link to your application. It lets you run several functions / procedures as parallel tasks. Join hundreds of satisfied customers who've been using RTKernel in the past three years. RTKernel offers these advanced features:

- pre-emptive, event- / interrupt-driven scheduling
- number of tasks only limited by RAM
- task-switch time of approx. 12 µsecs on a 33-MHz 486
- performance independent of the number of tasks
- use different priorities (changeable at run-time) to control your tasks
- time-slicing can be activated
- programmable timer interrupt rate
- high-resolution timer (approx. 1 µsec)
- inter-task communications using semaphores, mailboxes, and message-passing
- call DOS from any number of tasks without re-entrance problems!
- activate tasks out of interrupt handlers
- supports math coprocessor and emulator
- supports COM1 to COM4
- extensible to any number of COM ports
- interrupt handlers for keyboard and COM ports included with source code
- resident multi-tasking applications (TSRs)
- keyboard, hard disk, floppy disk idle times usable by other tasks
- runs under MS-DOS 3.0 to 5.0, DR-DOS, Novell, etc., or without operating system
- ROMable
- supports CodeView and Turbo Debugger
- full source code available
- no run-time royalties
- free technical support by phone or fax

RTKernel-C (MSC 6.0, TC++ 1.0, BC++ 2.0) ... DM 700 (for source code, add DM 600)
RTKernel-Pascal (TP 5.0, S.5, 6.0) DM 600 (for source code, add DM 500)

For international orders, add DM 50 for shipping and handling.
Visa, check, bank transfer, or COD (in Europe) accepted.

Please call or fax for our free demo disk.

On Time
MARKETING
KARSTEN PETERSEN

Karolinenstrasse 32 · D-2000 Hamburg 36 · Germany
Phone +49-40-43 74 72 · Fax +49-40-43 51 96

A MESSAGE TO OUR SUBSCRIBERS

FROM TIME TO TIME WE MAKE THE BYTE subscriber list available to other companies who wish to send our subscribers material about their products. We take great care to screen these companies, choosing only those who are reputable, and whose products, services, or information we feel would be of interest to you. Direct mail is an efficient medium for presenting the latest personal computer goods and services to our subscribers.

Many BYTE subscribers appreciate this controlled use of our mailing list, and look forward to finding information of interest to them in the mail. Used are our subscribers' names and addresses only (no other information we may have is ever given).

While we believe the distribution of this information is of benefit to our subscribers, we firmly respect the wishes of any subscriber who does not want to receive such promotional literature. Should you wish to restrict the use of your name, simply send your request to the following address.

BYTE MAGAZINE
ATTN: SUBSCRIBER SERVICE
P.O. Box 555
HIGHTSTOWN, NJ 08520



INTERNATIONAL RESOURCE GUIDE

SINGAPORE

BRS Software Products:
Far East Computers Private Ltd.
65-2738288
fax: 65-2780649
Circle 1148 on Inquiry Card.

SOUTH AFRICA

Johnston & Co.:
Phillip Burger
27-12-9987666
fax: 27-12-3489658
Circle 1163 on Inquiry Card.

SPAIN

BRS Software Products:
Servicios De Teledocumentacion S.A.
34-1-5939612
fax: 34-1-5939821
Circle 1148 on Inquiry Card.

SWITZERLAND

On Technology, Inc.:
Systrade A.G.
41-56835640
fax: 41-56835688
Circle 1168 on Inquiry Card.

THAILAND

BRS Software Products:
Summit Computer Co. Ltd.
66-2-2362716
fax: 66-2-2367392
Circle 1148 on Inquiry Card.

U.K.

askSam Systems:
Ingram Micro Services
44-819-511012
fax: 44-819-511012
Circle 1146 on Inquiry Card.

BRS Software Products:
BRS Software Products
44-71-5805271
fax: 44-71-4360997
Circle 1148 on Inquiry Card.

Folio Corp.:
Catalyst Electronic Publishing
44-892-541139
fax: 44-892-514537
Circle 1153 on Inquiry Card.

MicroRetrieval Corp.:
Techsonix Ltd.
44-21-3596436
fax: 44-21-3597830
Circle 1166 on Inquiry Card.

On Technology, Inc.:
Frontline Distribution
44-256-463344
fax: 44-256-479461
Circle 1168 on Inquiry Card.

SoftSolutions Technology Corp.:
Transam Microsystems Ltd.
44-71-8374050
fax: 44-71-8373804
Circle 1170 on Inquiry Card.

Virginia Systems, Inc.:
DataSale Ltd.
44-81-8714166
fax: 44-81-8714208
Circle 1176 on Inquiry Card.

VENEZUELA

Folio Corp.:
ENIAC C.A.
58-2-5746711
fax: 58-2-5741605
Circle 1153 on Inquiry Card.

MicroRetrieval Corp.:
Oficina Technica Lindo S.A.
58-2-9521616
fax: 58-2-9521294
Circle 1166 on Inquiry Card.

Inclusion in the resource guide should not be taken as a BYTE endorsement or recommendation. Likewise, omission from the guide should not be taken negatively. The information here was believed to be accurate at the time of writing, but BYTE cannot be responsible for omissions, errors, or changes that occur after compilation of the guide.

FREE PRODUCT INFORMATION

Mail Your Completed Card Today. For Quicker Response, Fax to 1-413-637-4343!

Circle the numbers on Inquiry Card which correspond to inquiry numbers assigned to items of interest to you.

2. Check all the appropriate answers to questions "A" through "E".

3. Print Your name and address and mail, or fax to 1-413-637-4343

Fill out this coupon carefully. PLEASE PRINT.

NAME _____
 TITLE _____
 COMPANY _____
 ADDRESS _____
 CITY _____ COUNTY _____ CODE _____
 PHONE _____ FAX _____

A. What is your primary job function/principal area of responsibility? (Check one.)
 1 MIS/DP
 2 Programmer/Systems Analyst
 3 Administration/Management
 4 Sales/Marketing
 5 Engineer/Scientist
 6 Other

B. What is your level of management responsibility?
 7 Senior-level
 8 Middle-level
 9 Professional

C. Are you a reseller (VAR, VAD, Dealer, Consultant)?
 10 Yes
 11 No

D. What operating systems are you currently using? (Check all that apply.)
 12 PC/MS-DOS
 13 DOS + Windows
 14 OS/2
 15 UNIX
 16 MacOS
 17 VAX/VMS

E. For how many people do you influence the purchase of hardware or software?
 18 1-25
 19 26-50
 20 51-99
 21 100 or more

Inquiry Numbers 1-493

- 1 2 3 4 5 6 7 8 9 10 11 12 13 14 15 16 17
- 18 19 20 21 22 23 24 25 26 27 28 29 30 31 32 33 34
- 35 36 37 38 39 40 41 42 43 44 45 46 47 48 49 50 51
- 52 53 54 55 56 57 58 59 60 61 62 63 64 65 66 67 68
- 69 70 71 72 73 74 75 76 77 78 79 80 81 82 83 84 85
- 86 87 88 89 90 91 92 93 94 95 96 97 98 99 100 101 102
- 103 104 105 106 107 108 109 110 111 112 113 114 115 116 117 118 119
- 120 121 122 123 124 125 126 127 128 129 130 131 132 133 134 135 136
- 137 138 139 140 141 142 143 144 145 146 147 148 149 150 151 152 153
- 154 155 156 157 158 159 160 161 162 163 164 165 166 167 168 169 170
- 171 172 173 174 175 176 177 178 179 180 181 182 183 184 185 186 187
- 188 189 190 191 192 193 194 195 196 197 198 199 200 201 202 203 204
- 205 206 207 208 209 210 211 212 213 214 215 216 217 218 219 220 221
- 222 223 224 225 226 227 228 229 230 231 232 233 234 235 236 237 238
- 239 240 241 242 243 244 245 246 247 248 249 250 251 252 253 254 255
- 256 257 258 259 260 261 262 263 264 265 266 267 268 269 270 271 272
- 273 274 275 276 277 278 279 280 281 282 283 284 285 286 287 288 289
- 290 291 292 293 294 295 296 297 298 299 300 301 302 303 304 305 306
- 307 308 309 310 311 312 313 314 315 316 317 318 319 320 321 322 323
- 324 325 326 327 328 329 330 331 332 333 334 335 336 337 338 339 340
- 341 342 343 344 345 346 347 348 349 350 351 352 353 354 355 356 357
- 358 359 360 361 362 363 364 365 366 367 368 369 370 371 372 373 374
- 375 376 377 378 379 380 381 382 383 384 385 386 387 388 389 390 391
- 392 393 394 395 396 397 398 399 400 401 402 403 404 405 406 407 408
- 409 410 411 412 413 414 415 416 417 418 419 420 421 422 423 424 425
- 426 427 428 429 430 431 432 433 434 435 436 437 438 439 440 441 442
- 443 444 445 446 447 448 449 450 451 452 453 454 455 456 457 458 459
- 460 461 462 463 464 465 466 467 468 469 470 471 472 473 474 475 476
- 477 478 479 480 481 482 483 484 485 486 487 488 489 490 491 492 493

Inquiry Numbers 494-986

- 494 495 496 497 498 499 500 501 502 503 504 505 506 507 508 509 510
- 511 512 513 514 515 516 517 518 519 520 521 522 523 524 525 526 527
- 528 529 530 531 532 533 534 535 536 537 538 539 540 541 542 543 544
- 545 546 547 548 549 550 551 552 553 554 555 556 557 558 559 560 561
- 562 563 564 565 566 567 568 569 570 571 572 573 574 575 576 577 578
- 579 580 581 582 583 584 585 586 587 588 589 590 591 592 593 594 595
- 596 597 598 599 600 601 602 603 604 605 606 607 608 609 610 611 612
- 613 614 615 616 617 618 619 620 621 622 623 624 625 626 627 628 629
- 630 631 632 633 634 635 636 637 638 639 640 641 642 643 644 645 646
- 647 648 649 650 651 652 653 654 655 656 657 658 659 660 661 662 663
- 664 665 666 667 668 669 670 671 672 673 674 675 676 677 678 679 680
- 681 682 683 684 685 686 687 688 689 690 691 692 693 694 695 696 697
- 698 699 700 701 702 703 704 705 706 707 708 709 710 711 712 713 714
- 715 716 717 718 719 720 721 722 723 724 725 726 727 728 729 730 731
- 732 733 734 735 736 737 738 739 740 741 742 743 744 745 746 747 748
- 749 750 751 752 753 754 755 756 757 758 759 760 761 762 763 764 765
- 766 767 768 769 770 771 772 773 774 775 776 777 778 779 780 781 782
- 783 784 785 786 787 788 789 790 791 792 793 794 795 796 797 798 799
- 800 801 802 803 804 805 806 807 808 809 810 811 812 813 814 815 816
- 817 818 819 820 821 822 823 824 825 826 827 828 829 830 831 832 833
- 834 835 836 837 838 839 840 841 842 843 844 845 846 847 848 849 850
- 851 852 853 854 855 856 857 858 859 860 861 862 863 864 865 866 867
- 868 869 870 871 872 873 874 875 876 877 878 879 880 881 882 883 884
- 885 886 887 888 889 890 891 892 893 894 895 896 897 898 899 900 901
- 902 903 904 905 906 907 908 909 910 911 912 913 914 915 916 917 918
- 919 920 921 922 923 924 925 926 927 928 929 930 931 932 933 934 935
- 936 937 938 939 940 941 942 943 944 945 946 947 948 949 950 951 952
- 953 954 955 956 957 958 959 960 961 962 963 964 965 966 967 968 969
- 970 971 972 973 974 975 976 977 978 979 980 981 982 983 984 985 986

Inquiry Numbers 987-1479

- 987 988 989 990 991 992 993 994 995 996 997 998 999 1000 1001 1002 1003
- 1004 1005 1006 1007 1008 1009 1010 1011 1012 1013 1014 1015 1016 1017 1018 1019 1020
- 1021 1022 1023 1024 1025 1026 1027 1028 1029 1030 1031 1032 1033 1034 1035 1036 1037
- 1038 1039 1040 1041 1042 1043 1044 1045 1046 1047 1048 1049 1050 1051 1052 1053 1054
- 1055 1056 1057 1058 1059 1060 1061 1062 1063 1064 1065 1066 1067 1068 1069 1070 1071
- 1072 1073 1074 1075 1076 1077 1078 1079 1080 1081 1082 1083 1084 1085 1086 1087 1088
- 1089 1090 1091 1092 1093 1094 1095 1096 1097 1098 1099 1100 1101 1102 1103 1104 1105
- 1106 1107 1108 1109 1110 1111 1112 1113 1114 1115 1116 1117 1118 1119 1120 1121 1122
- 1123 1124 1125 1126 1127 1128 1129 1130 1131 1132 1133 1134 1135 1136 1137 1138 1139
- 1140 1141 1142 1143 1144 1145 1146 1147 1148 1149 1150 1151 1152 1153 1154 1155 1156
- 1157 1158 1159 1160 1161 1162 1163 1164 1165 1166 1167 1168 1169 1170 1171 1172 1173
- 1174 1175 1176 1177 1178 1179 1180 1181 1182 1183 1184 1185 1186 1187 1188 1189 1190
- 1191 1192 1193 1194 1195 1196 1197 1198 1199 1200 1201 1202 1203 1204 1205 1206 1207
- 1208 1209 1210 1211 1212 1213 1214 1215 1216 1217 1218 1219 1220 1221 1222 1223 1224
- 1225 1226 1227 1228 1229 1230 1231 1232 1233 1234 1235 1236 1237 1238 1239 1240 1241
- 1242 1243 1244 1245 1246 1247 1248 1249 1250 1251 1252 1253 1254 1255 1256 1257 1258
- 1259 1260 1261 1262 1263 1264 1265 1266 1267 1268 1269 1270 1271 1272 1273 1274 1275
- 1276 1277 1278 1279 1280 1281 1282 1283 1284 1285 1286 1287 1288 1289 1290 1291 1292
- 1293 1294 1295 1296 1297 1298 1299 1300 1301 1302 1303 1304 1305 1306 1307 1308 1309
- 1310 1311 1312 1313 1314 1315 1316 1317 1318 1319 1320 1321 1322 1323 1324 1325 1326
- 1327 1328 1329 1330 1331 1332 1333 1334 1335 1336 1337 1338 1339 1340 1341 1342 1343
- 1344 1345 1346 1347 1348 1349 1350 1351 1352 1353 1354 1355 1356 1357 1358 1359 1360
- 1361 1362 1363 1364 1365 1366 1367 1368 1369 1370 1371 1372 1373 1374 1375 1376 1377
- 1378 1379 1380 1381 1382 1383 1384 1385 1386 1387 1388 1389 1390 1391 1392 1393 1394
- 1395 1396 1397 1398 1399 1400 1401 1402 1403 1404 1405 1406 1407 1408 1409 1410 1411
- 1412 1413 1414 1415 1416 1417 1418 1419 1420 1421 1422 1423 1424 1425 1426 1427 1428
- 1429 1430 1431 1432 1433 1434 1435 1436 1437 1438 1439 1440 1441 1442 1443 1444 1445
- 1446 1447 1448 1449 1450 1451 1452 1453 1454 1455 1456 1457 1458 1459 1460 1461 1462
- 1463 1464 1465 1466 1467 1468 1469 1470 1471 1472 1473 1474 1475 1476 1477 1478 1479

JUNE
426EINT

PLACE
POSTAGE
HERE

BYTE
 TNT MAILFAST
 FRG/BOS/700252/M01
 P.O. Box 66
 Hounslow
 TW5 9RT
 England

FREE PRODUCT INFORMATION

Mail Your Completed Card Today. For Quicker Response, Fax to 1-413-637-4343!

1. Circle the numbers on Inquiry Card which correspond to inquiry numbers assigned to items of interest to you.

2. Check all the appropriate answers to questions "A" through "E".

3. Print Your name and address and mail, or fax to 1-413-637-4343

PLACE
POSTAGE
HERE

BYTE

TNT MAILFAST
FRG/BOS/700252/MO1
P.O. Box 66
Hounslow
TW5 9RT
England

Fill out this coupon carefully. PLEASE PRINT.

NAME _____
TITLE _____
COMPANY _____
ADDRESS _____
CITY () COUNTY () CODE _____
PHONE () FAX _____

A. What is your primary job function/principal area of responsibility? (Check one.)

- 1 MIS/DP
2 Programmer/Systems Analyst
3 Administration/Management
4 Sales/Marketing
5 Engineer/Scientist
6 Other

B. What is your level of management responsibility?

- 7 Senior-level
8 Middle-level
9 Professional

C. Are you a reseller (VAR, VAD, Dealer, Consultant)?

- 10 Yes
11 No

D. What operating systems are you currently using? (Check all that apply.)

- 12 PC/MS-DOS
13 DOS + Windows
14 OS/2
15 UNIX
16 MacOS
17 VAX/VMS

E. For how many people do you influence the purchase of hardware or software?

- 18 1-25
19 26-50
20 51-99
21 100 or more

Inquiry Numbers 1-493

1 2 3 4 5 6 7 8 9 10 11 12 13 14 15 16 17
18 19 20 21 22 23 24 25 26 27 28 29 30 31 32 33 34
35 36 37 38 39 40 41 42 43 44 45 46 47 48 49 50 51
52 53 54 55 56 57 58 59 60 61 62 63 64 65 66 67 68
69 70 71 72 73 74 75 76 77 78 79 80 81 82 83 84 85
86 87 88 89 90 91 92 93 94 95 96 97 98 99 100 101 102
103 104 105 106 107 108 109 110 111 112 113 114 115 116 117 118 119
120 121 122 123 124 125 126 127 128 129 130 131 132 133 134 135 136
137 138 139 140 141 142 143 144 145 146 147 148 149 150 151 152 153
154 155 156 157 158 159 160 161 162 163 164 165 166 167 168 169 170
171 172 173 174 175 176 177 178 179 180 181 182 183 184 185 186 187
188 189 190 191 192 193 194 195 196 197 198 199 200 201 202 203 204
205 206 207 208 209 210 211 212 213 214 215 216 217 218 219 220 221
222 223 224 225 226 227 228 229 230 231 232 233 234 235 236 237 238
239 240 241 242 243 244 245 246 247 248 249 250 251 252 253 254 255
256 257 258 259 260 261 262 263 264 265 266 267 268 269 270 271 272
273 274 275 276 277 278 279 280 281 282 283 284 285 286 287 288 289
290 291 292 293 294 295 296 297 298 299 300 301 302 303 304 305 306
307 308 309 310 311 312 313 314 315 316 317 318 319 320 321 322 323
324 325 326 327 328 329 330 331 332 333 334 335 336 337 338 339 340
341 342 343 344 345 346 347 348 349 350 351 352 353 354 355 356 357
358 359 360 361 362 363 364 365 366 367 368 369 370 371 372 373 374
375 376 377 378 379 380 381 382 383 384 385 386 387 388 389 390 391
392 393 394 395 396 397 398 399 400 401 402 403 404 405 406 407 408
409 410 411 412 413 414 415 416 417 418 419 420 421 422 423 424 425
426 427 428 429 430 431 432 433 434 435 436 437 438 439 440 441 442
443 444 445 446 447 448 449 450 451 452 453 454 455 456 457 458 459
460 461 462 463 464 465 466 467 468 469 470 471 472 473 474 475 476
477 478 479 480 481 482 483 484 485 486 487 488 489 490 491 492 493

Inquiry Numbers 494-986

494 495 496 497 498 499 500 501 502 503 504 505 506 507 508 509 510
511 512 513 514 515 516 517 518 519 520 521 522 523 524 525 526 527
528 529 530 531 532 533 534 535 536 537 538 539 540 541 542 543 544
545 546 547 548 549 550 551 552 553 554 555 556 557 558 559 560 561
562 563 564 565 566 567 568 569 570 571 572 573 574 575 576 577 578
579 580 581 582 583 584 585 586 587 588 589 590 591 592 593 594 595
596 597 598 599 600 601 602 603 604 605 606 607 608 609 610 611 612
613 614 615 616 617 618 619 620 621 622 623 624 625 626 627 628 629
630 631 632 633 634 635 636 637 638 639 640 641 642 643 644 645 646
647 648 649 650 651 652 653 654 655 656 657 658 659 660 661 662 663
664 665 666 667 668 669 670 671 672 673 674 675 676 677 678 679 680
681 682 683 684 685 686 687 688 689 690 691 692 693 694 695 696 697
698 699 700 701 702 703 704 705 706 707 708 709 710 711 712 713 714
715 716 717 718 719 720 721 722 723 724 725 726 727 728 729 730 731
732 733 734 735 736 737 738 739 740 741 742 743 744 745 746 747 748
749 750 751 752 753 754 755 756 757 758 759 760 761 762 763 764 765
766 767 768 769 770 771 772 773 774 775 776 777 778 779 780 781 782
783 784 785 786 787 788 789 790 791 792 793 794 795 796 797 798 799
800 801 802 803 804 805 806 807 808 809 810 811 812 813 814 815 816
817 818 819 820 821 822 823 824 825 826 827 828 829 830 831 832 833
834 835 836 837 838 839 840 841 842 843 844 845 846 847 848 849 850
851 852 853 854 855 856 857 858 859 860 861 862 863 864 865 866 867
868 869 870 871 872 873 874 875 876 877 878 879 880 881 882 883 884
885 886 887 888 889 890 891 892 893 894 895 896 897 898 899 900 901
902 903 904 905 906 907 908 909 910 911 912 913 914 915 916 917 918
919 920 921 922 923 924 925 926 927 928 929 930 931 932 933 934 935
936 937 938 939 940 941 942 943 944 945 946 947 948 949 950 951 952
953 954 955 956 957 958 959 960 961 962 963 964 965 966 967 968 969
970 971 972 973 974 975 976 977 978 979 980 981 982 983 984 985 986

Inquiry Numbers 987-1479

987 988 989 990 991 992 993 994 995 996 997 998 999 1000 1001 1002 1003
1004 1005 1006 1007 1008 1009 1010 1011 1012 1013 1014 1015 1016 1017 1018 1019 1020
1021 1022 1023 1024 1025 1026 1027 1028 1029 1030 1031 1032 1033 1034 1035 1036 1037
1038 1039 1040 1041 1042 1043 1044 1045 1046 1047 1048 1049 1050 1051 1052 1053 1054
1055 1056 1057 1058 1059 1060 1061 1062 1063 1064 1065 1066 1067 1068 1069 1070 1071
1072 1073 1074 1075 1076 1077 1078 1079 1080 1081 1082 1083 1084 1085 1086 1087 1088
1089 1090 1091 1092 1093 1094 1095 1096 1097 1098 1099 1100 1101 1102 1103 1104 1105
1106 1107 1108 1109 1110 1111 1112 1113 1114 1115 1116 1117 1118 1119 1120 1121 1122
1123 1124 1125 1126 1127 1128 1129 1130 1131 1132 1133 1134 1135 1136 1137 1138 1139
1140 1141 1142 1143 1144 1145 1146 1147 1148 1149 1150 1151 1152 1153 1154 1155 1156
1157 1158 1159 1160 1161 1162 1163 1164 1165 1166 1167 1168 1169 1170 1171 1172 1173
1174 1175 1176 1177 1178 1179 1180 1181 1182 1183 1184 1185 1186 1187 1188 1189 1190
1191 1192 1193 1194 1195 1196 1197 1198 1199 1200 1201 1202 1203 1204 1205 1206 1207
1208 1209 1210 1211 1212 1213 1214 1215 1216 1217 1218 1219 1220 1221 1222 1223 1224
1225 1226 1227 1228 1229 1230 1231 1232 1233 1234 1235 1236 1237 1238 1239 1240 1241
1242 1243 1244 1245 1246 1247 1248 1249 1250 1251 1252 1253 1254 1255 1256 1257 1258
1259 1260 1261 1262 1263 1264 1265 1266 1267 1268 1269 1270 1271 1272 1273 1274 1275
1276 1277 1278 1279 1280 1281 1282 1283 1284 1285 1286 1287 1288 1289 1290 1291 1292
1293 1294 1295 1296 1297 1298 1299 1300 1301 1302 1303 1304 1305 1306 1307 1308 1309
1310 1311 1312 1313 1314 1315 1316 1317 1318 1319 1320 1321 1322 1323 1324 1325 1326
1327 1328 1329 1330 1331 1332 1333 1334 1335 1336 1337 1338 1339 1340 1341 1342 1343
1344 1345 1346 1347 1348 1349 1350 1351 1352 1353 1354 1355 1356 1357 1358 1359 1360
1361 1362 1363 1364 1365 1366 1367 1368 1369 1370 1371 1372 1373 1374 1375 1376 1377
1378 1379 1380 1381 1382 1383 1384 1385 1386 1387 1388 1389 1390 1391 1392 1393 1394
1395 1396 1397 1398 1399 1400 1401 1402 1403 1404 1405 1406 1407 1408 1409 1410 1411
1412 1413 1414 1415 1416 1417 1418 1419 1420 1421 1422 1423 1424 1425 1426 1427 1428
1429 1430 1431 1432 1433 1434 1435 1436 1437 1438 1439 1440 1441 1442 1443 1444 1445
1446 1447 1448 1449 1450 1451 1452 1453 1454 1455 1456 1457 1458 1459 1460 1461 1462
1463 1464 1465 1466 1467 1468 1469 1470 1471 1472 1473 1474 1475 1476 1477 1478 1479

JUNE
426EINT



JERRY
POURNELLE

THE MAC GOES TO SCHOOL

For the last six weeks, I have had three different strains of flu, and for a while I wondered if I'd ever feel good again. The frustrating part would be sitting down to work. Hours would go by, and I'd produce a dozen lines. I would shout, "I'm trying to think and nothing happens!" in hopes of making a joke of it, but there was a lot of truth to that, and it was a frightening experience.

Then a week ago, suddenly all was well.

The big news is that Larry Niven and I have finished *The Moat Around God's Eye* and shipped it off to our agent. If that weren't enough to rejoice over, I managed to get something done for the Smithsonian and start a new novelette; and of course I'm getting this column out. It's great to be back.

The Productivity Paradox

There are 100 million small computers in the U.S., but efficiency experts claim they've had little or no effect on productivity, and the experts are puzzled. They needn't be. What happened is that small computers made it possible to comply with more government regulations and bureaucratic red tape. Since that kind of work always expands to fill the available capacity to do it, we ended up with an ever-increasing stream of new regulations.

Worse, computers make it easier for the government to force compliance. We have plenty of new productivity: you just don't see it, because it's been absorbed in regulations and compliance documents.

The Macintosh Story

When the Macintosh first came out I thought it was unfinished. The operating-system concept was excellent. I had a Lilith, a machine conceived by Niklaus Wirth, when I first saw the Mac's very slow predecessor (called Lisa), so I was already familiar with the operating-system principles. The Mac, like the Lilith, was a giant step forward in usability over CP/M and its DOS followers. Unfortunately, this potentially winning operating system was attached to a toy computer. There wasn't enough memory, it was prone to overheating, and the 68000 chip was badly overworked in its triple duties as drive controller, screen manager, and CPU.

Worse, we were told that the 128-KB Mac was all there ever would be; Steve Jobs was adamant in insisting that this was good enough. Developers could safely write for this Mac, as there would be no upgrade.

Of course, no one believed him. It was just too obvious that the 128-KB Mac was inadequate. Eventually there

came a bewildering series of upgrades, some of which appeared only to soon vanish. There was also a long series of software improvements, culminating in System 7.0.

My early observations about the 128-KB Mac gave many people the impression that I didn't like the Mac at all. This was spurred on by the fanatic loyalty of some of the early 128-KB Mac users. (I suspect they knew better, but having paid so much for the machine, they had no choice but to defend it.)

The truth is, though, I bought a 128-KB Mac and acquired every Mac upgrade, from the first Mac to the "Fat Mac" (with an internal 5-MB hard drive and more memory), on through different stages to the Plus. I used that machine to do my taxes every year. More important, that early Mac has always been available to my children. The youngest one, Richard, pretty well grew up with it.

The legend is that the cobbler's children go barefoot. But when Richard enrolled at UCLA, I wanted him to have a decent computer. He had for years had both Mac and PC machines available, and he knew what he wanted. He wanted a Mac, but preferably not my original 128-KB system with all its upgrades. He would have liked one of the new Mac II machines, but it didn't look to me as if he'd need that. After some thought, we decided on a Mac Classic II.

He's been using that for about a year now, and I can confidently say that a Mac Classic II is an excellent choice for high school and liberal arts college students. Engineering and science majors will probably want something fancier, but the Mac Classic II is a lot of machine for the money.

Outfitting Your Mac

Alas, the Mac Classic II isn't very useful as it comes out of the box; neither is the top-of-the-line Quadra, for that

**Jerry makes
recommendations on
computers for
the college crowd**



CD-ROM



Great Literature Personal Library Series

The Full Text Of 943 Works!!! Multimedia disc includes celebrity narrations of famous quotes, selected period music excerpts, pictures & engravings. PC & Mac
"...the time has finally come to curl up with a good computer". - The New York Times
Breakthrough Price ----- Only \$99

Multimedia CIA World Tour

MPC Title! With info straight from the CIA -- Plus Maps from Hammond, Inc. and flags & National Anthem segments New Version! **\$49**

Monarch Notes on CD-ROM

Over 200 Study Guides on One CD-ROM Disc - The Entire Collection (many out of print) The definitive multimedia source for understanding the world's greatest literature. *User's Choice CD-ROM of the Year* - Byte Magazine *Mondo Cool Award* - Computer Shopper PC & Mac **Only \$99**

Countries of The World Encyclopedia

Full text of over 100 Study Books, Maps, National Anthems, Flags, Photos & More! Includes the latest info from over 100 embassies. The perfect research tool for students and anyone who wants to know more about our world. PC & Mac **\$395**

U.S. History on CD-ROM

WINNER 1991 OPA BEST EDUCATIONAL PRODUCT Full Text & Images of 107 books providing you with social, economic, political, scientific and military perspectives of U.S. History. PC/Mac **\$395**

Disc Caddies 5 for \$49

Multimedia CD-ROM Titles

- Microsoft Bookshelf best selling CD-ROM disc Best Price
- Beethoven's Multimedia MPC classic disc \$79
- Grolier's Encyclopedia 21 volumes, VGA pictures Call
- Mammals - Nat. Geographic/IBM pictures & text Call
- Presidents - Nat. Geographic/IBM pictures & text Call
- Between Heaven & Hell II even stranger 99
- Street Atlas Windows map with every US street Call
- Family Doctor home medical guide 98
- McGraw-Hill Ref. Set 100,000 terms, 7,300 articles 495
- Oxford Textbook of Medicine general reference 595
- PC-Sig Library new edition, newest version Call
- Phonedisc USA Telephone Directory - East or West 989

Bureau On-Line CD-ROM Library, FREE access to 12 different CD-ROM Discs. CALL !!!

GSA# GS00K91AGS5280

HOURS M-F 8:30am - 6:30pm EST



Bureau of Electronic Publishing, Inc.

Dept. B, 141 New Road, Parsippany, NJ 07054

FAX # 201-808-2676

CALL: **800-828-4766** ORDERS

201-808-2700 INFORMATION

USER'S COLUMN

matter. For reasons I've never understood, Apple ships these machines woefully deficient of memory. The Classic II has barely enough memory to run System 7.0; if you want it to do anything useful, you must turn off features and use tricks. This implies a computer sophistication a great deal higher than most college students have. Apple has put out some free software that helps, but it's still a kludge; it's better to add memory.

Fortunately, adding memory is simple and not very costly. Ours came from Technology Works. When the first 2-MB package of memory arrived, we thought we'd put it in the Quadra, because Roberta kept having memory-limit problems. That turned out to be impossible: the Quadra will accept memory only in 4-MB blocks.

Technology Works memory comes with complete instructions for installation in just about any Mac, including the Classic II. Now, while my oldest son Alex is a typical computer techno-weenie, his youngest brother most decidedly is not. Richard is the debate team captain and will do well in whatever scholarly profession he chooses—but a computer techie he is not. It was thus with some trepidation that I handed him the memory package. But it all worked out well. He says, "All the small Macs always have been a pain to open up and install stuff inside." But he had no real trouble. The early Macs used Torx fasteners to make it more difficult to open the case, but the Classic II uses ordinary slotted screws.

Observations by Richard

His most emphatic warning is to confirm that you need additional memory: the Classic II with System 7.0 uses so much memory on start-up that many programs that worked fine on a Mac Plus won't work at all on the Classic II as it comes out of the box. On the other hand, System 7.0 is pre-installed; some previous Mac OS updates were complicated and tedious, but that doesn't apply here.

Richard's second warning: don't use virtual memory. He has found that it won't work with many programs, and you can't print more than a single page on a Hewlett-Packard ink-jet printer with virtual memory turned on. ("It freaks out and prints gibberish.") I'm told that there are upgrades to virtual memory that fix many of the major bugs, but Richard's advice is to buy more memory and leave virtual memory off.

He also notes that the Mac Classic II, unclassically, has a built-in fan; you no longer need one of those external fan devices that sit on top and draw air up through the vent slots. We had one for the

Mac Plus, and it needed it, too.

Richard and his roommates have concluded that the HP DeskWriter 2279A is the best buy for a printer, a good compromise between speed and price. No one cares much for the ImageWriter II.

Incidentally, my first Mac printer was the original ImageWriter; it was slow and a bit of a pain to use, as well as noisy. The DeskWriter ink-jet printer is a joy by comparison. The ultimate printing system is a LaserWriter, but Richard and his friends have found that they don't need anything so fancy, and the DeskWriter works just fine for homework, letters, and suchlike. They also have a Seikosha SP-2000AP. It is slow and noisy, but it's very cheap—its street price is under \$100—and as Richard says, "It gets the job done, only really slowly."

Students will also need a modem and communications software. Richard has an Intel 14.4EX (14,400 bps, V.42bis, and MNP level 5). That's considerably more modem than a student needs, but I wanted it tested in a harsh environment. We're pleased to say that the Intel modem was easy to install (he only had to buy a cable), and it has worked splendidly. This modem is particularly useful for data transfer when there's a similarly fast modem on the other end.

We don't have a CD-ROM drive on Richard's machine just now, but I think that's a mistake, and we're getting one set up for him. There is a great deal of CD-ROM educational software—enough that it's worth having a CD-ROM drive—and I recommend that you get one when outfitting a student's Mac. Many CD-ROM drives will work with the Mac as well as PCompatible machines; it's important to get the proper CD-ROM software. An easy way to do this is to contact the Bureau of Electronic Publishing (141 New Rd., Parsippany, NJ 07054, (800) 828-4766 or (201) 808-2700; fax (201) 808-2676) and get their catalog; the catalog is a good introduction to the world of CD-ROM for both the PC and the Mac. The Bureau's hardware prices are generally competitive, and their technical support is excellent.

An item that may be worth having is a scanner. Logitech makes a full line of PC and Mac hand-held scanners. Scanners are more useful for students who need to build visual databases than for liberal arts majors. But, coupled with OCR (optical character recognition) software, they can be useful for dragging in material (e.g., text and illustrative diagrams) to be quoted in term papers.

A final hardware item for a Mac would be some reasonable-quality stereo speakers. These plug into the CD-ROM box.

continued

LOOK AT THE INSIDE STORY ON POWER SUPPLIES.

What power supply is inside your computer? If you are like most people, you don't know, and frankly, don't care.

But, because your computer's power supply is a critical system component, what you don't know, may hurt you. An inferior power supply can cause interference, rebooting, hard drive errors, and other nasty hard-to-track problems. So why take chances? Call the power supply specialists at PC Power and Cooling today.

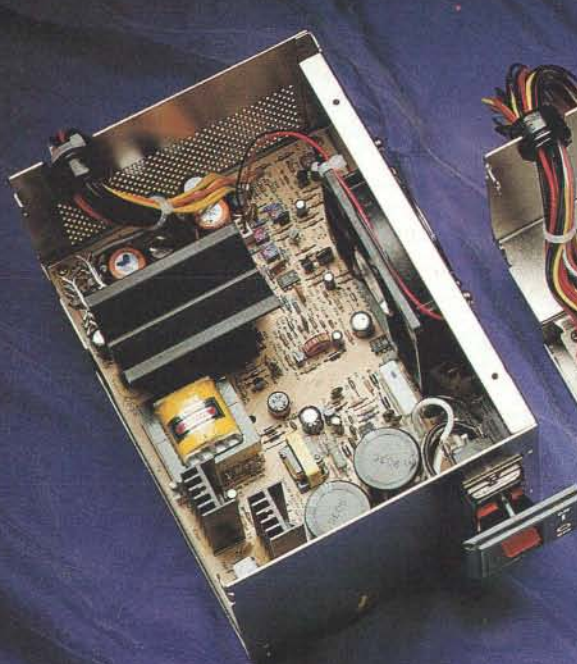

Turbo-Cool 300

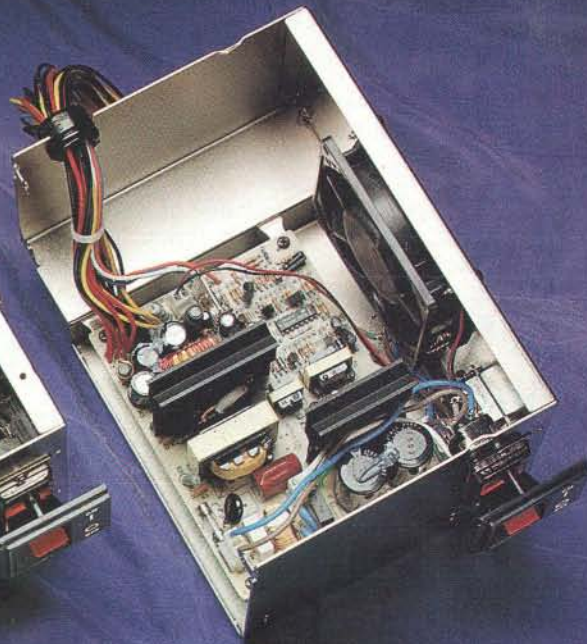

Ordinary Power Supply

HERE ARE TEN GREAT REASONS TO SELECT THE INDUSTRY'S BEST, THE TURBO-COOL™ 300 AND TURBO-COOL™ 450.

1. 50% TO 100% MORE POWER

The more power, the better! Our high-capacity units start drive motors with ease, run cooler, last longer, and allow for future expansion.

2. BUILT-IN LINE CONDITIONING

Turbo-Cool power supplies won't skip a beat when the line voltage sags. Their wide input range (85-135V, 170-270V) and heavy-duty input components protect your PC and its data from sags, surges and spikes.

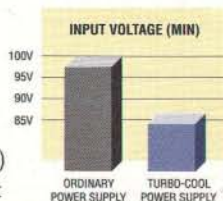

3. FCC-B AND VDE-B LINE FILTER

A dual-stage EMI filter keeps electrical noise well below agency standards.

4. INDEPENDENT REGULATION

Turbo-Cool's superior independent-regulation design keeps output voltage tolerances 20 times tighter than that of an ordinary

power supply. This exceptional stability improves hard drive reliability during critical access periods.

5. ULTRA-CLEAN DC OUTPUT

A dual-stage output filter ensures that sensitive computer chips receive pure, low-ripple power.

6. PROTECTION CIRCUITRY

Our units offer the most complete protection from dangerous overvoltage, overcurrent, and short circuit conditions.

7. THERMASENSE™ COOLING FAN

The Turbo-Cool 300 features ThermaSense, our high-capacity, thermostatically-controlled, variable-speed fan. It's ideal! High-performance systems operate up to 35° cooler while standard ones run as much as 75% quieter.

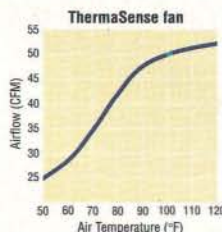

8. UL/CSA/TUV APPROVALS

Our high-capacity units are safety approved by not only UL, but also by Canada's CSA and Germany's strict TUV.

9. TWO-YEAR WARRANTY

Turbo-Cools are designed and tested for MTBFs of over 100,000 hours. They come with a no-hassle 2-year warranty and a 30-day money-back guarantee.

10. GREAT VALUE

Loaded with premium features, a Turbo-Cool power supply will upgrade the performance of your PC or LAN file server at a retail cost of only 55¢ to 80¢ per watt. You'll be powered by a unit that is popular with award-winning PC manufacturers and recommended by experts such as the PC Magazine Advisor!



Turbo-Cool 450

PC POWER & COOLING, INC.

5995 Avenida Encinas, Carlsbad, CA 92008 • (619) 931-5700 • (800) 722-6555 • Fax (619) 931-6988

Circle 137 on Inquiry Card (RESELLERS: 138).

There's a great deal of music software (see below) and other instructive material available as audio output on CD-ROM. I tend to use Radio Shack speakers; you can get a surprisingly good stereo pair for about \$30. You can spend a lot more. Since I'm partly deaf, I am not the person to consult about audio quality.

Where to Get a Mac

The best place for a college student to obtain a Mac is in the college bookstore. At

UCLA they will let you buy one (and only one) computer (when you show a student ID) at the educational discount price, which will probably be lower than the prices anywhere else. On the other hand, their prices for software and accessories are high—considerably higher than advertised street prices.

It's wise to shop around. However, some places advertise Macs at what look like low prices, but then you find that's without software or keyboards. When you

add it all up, it will be higher than the college bookstore price.

Form Factor

Richard grew up with a Mac, but he really dislikes the small screen and cramped keyboard of what he calls "normal Macs." The Classic II keyboard is much nicer than the original Mac keyboard: the action is better, and the mouse is better constructed. On the other hand, the small size does make for some awkward key placements.

The screen size is even more troublesome. It really is harder to work with the small screen, because it doesn't show as much text as a larger one, and the image of what's there is smaller. This isn't as much of a disadvantage to young eyes as it would be to mine, but I note the beginnings of a campaign to get me to swap Richard's Classic II for a larger-screen Mac II.

Richard thinks the only reason to prefer the smaller Mac is price; he doesn't see any real advantage to the smaller form factor. Students aren't generally cramped for desk space, and, given his druthers, he'd prefer the Mac II with a larger screen.

Software

No matter what a student's major, the primary use of a college Mac will be word processing. There are a million word processors out there, and most of them have good points. Richard had his choice of all of them, and he finds Microsoft Word the most congenial. It has the capability of easy transfer of files to a PCompatible and back to the Mac, which can be useful to those involved in debating or on other team intellectual projects.

Microsoft Word has more features than most will ever need, and it's not inexpensive; on the other hand, it handles footnotes well and makes it easy to insert equations and diagrams into a term paper. Word is often available at deeply discounted prices, and it will be all the word processor you'll ever need.

One step down would be Microsoft Works, which is generally good enough. It also contains a reasonable database and spreadsheet. It makes charts and graphs, and while it won't handle equations and footnotes anywhere near as well as Word does, it sure beats the typewriter I had to do all my homework on. I have never used Works on a Mac, but I have a Windows version that's not bad at all; the only reason I don't use it is that I've gotten used to other word processors, databases, and spreadsheets.

Works' ability to transfer data among the three functions is a very great plus: if things are easy to do, you'll do them more often, and that kind of embellishment can

Electronics Workbench®

The electronics lab in a computer™

Powerful software to build and simulate analog and digital circuits.

Building and testing circuits is fast and easy with *Electronics Workbench*. Just click-and-drag with a mouse to add parts, run wires, and adjust instruments. The traces on the simulated instruments are the same as you'd get on real equipment.

Electronics Workbench really is an electronics lab in a computer. It's ideal for learning about electronics, experimenting, and prototyping circuits.

"Electronics Workbench is pretty amazing." — Jerry Pournelle, Ph.D., *InfoWorld*

DOS Professional Version - \$299
Macintosh Version - \$199

Electronics Workbench includes:

- **Analog Module** with passive and active components including transistors, diodes, and op-amps; a function generator, an oscilloscope, a multimeter, and a Bode plotter.
- **Digital Module** with gates, flip-flops, adders, a word generator, a logic analyzer, and a unique logic converter and simplifier.

(416) 361-0333

Interactive Image Technologies Ltd.
908 Niagara Falls Boulevard
North Tonawanda, NY
14120-2060
Fax (416) 368-5799

Prices are in US dollars. Offer valid in the USA and Canada only. Macintosh Version is monochrome only. All trademarks are the property of their respective owners.

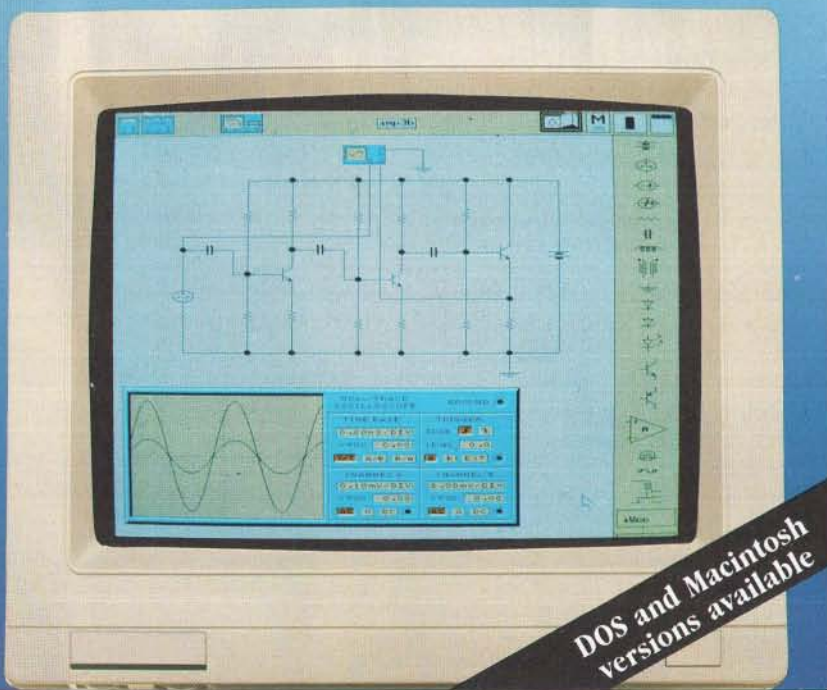



START OVER
Imported EISA board
has no tech support.

GO BACK 1 SPACE
Discount board
has compatibility
problems

Now Available
50 MHz

START
HERE

Cheap board fails in
UNIX system

Select Dependable AMI
EISA motherboards

No AMI
EISA BIOS

Discount
boards not
worth the savings

AMI EISA

The Only Game In Town

For EISA, there is only one player to consider—AMI. Whether it's motherboards, BIOS, utilities, or SCSI host adapters, AMI is the single source for advanced EISA technology.

ADVANCED EISA & MODULAR CPU MOTHERBOARDS

With AMI leading the way in EISA motherboard designs, you will benefit from bulletproof performance and proven reliability.

- EZ-Flex—A new modular CPU design offering easy upgrades to future technology.
- Enterprise II—A proven EISA performer, popular for critical applications.



THE LEADING EISA BIOS

AMI is the world-wide standard for BIOS. AMI's EISA BIOS provides the reliability, compatibility, and features you desire. Plus, it's compatible with AMI's BIOS Configuration Utility, providing on-site customization for the Integrator or OEM.

Circle 77 on Inquiry Card (RESELLERS: 78).



SINGLE SOURCE TECHNOLOGY

AMERICAN MEGATRENDS, INC.
800-U-BUY-AMI or 800-828-9264, 404-263-8181, fax 404-263-9381

Discount EISA boards
have high failure rate

Discount board has
slow video speed

Use highly compatible
AMI EISA BIOS

GO TO BANKRUPTCY

GO BACK 3 SPACES

LOSE TURN

PROFITABLE PARKING



EISA UTILITIES MAKE THE JOB SIMPLE

AMI designed and developed the EISA Configuration Utility to make configuring EISA products a snap. Run the ECU and select the auto configuration option, or modify the I/O ports, interrupts, or DMA settings as you desire.

EISA ADD-ON CARDS

The Fast Disk EISA SCSI Host Adapter, with a combination of 16 MB cache, and intelligent 386SX I/O management, is the fastest SCSI host adapter on the market today. Look to AMI for other EISA cards in the near future.

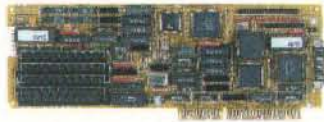

THE AMI DIFFERENCE

AMI's expertise covers the entire EISA environment. With research, engineering and support functions under one roof, AMI is unmatched in knowledge and support. Call AMI, and you will understand why AMI's "monopoly" on EISA makes it the only game in town.

Imported board
proves unreliable

GO BACK 1 SPACE

Use AMI EISA for
reliable network
file server

MOVE AHEAD 2 SPACES

Slow SCSI
interface
ruins reputation

GO BACK 3 SPACES

make for impressive homework and term papers. I have no hesitation in recommending Microsoft Works as a good first program for students. By the time they need more power, they'll have a better idea of what they want.

Grammatik IV

Richard also finds the Grammatik grammar and style checker very useful and believes it has helped his grades. I share that opinion. I don't often use Grammatik on my own work, but as a professional writer, I wouldn't be expected to. However, when I do run Grammatik against my text, it will often call my attention to passages that need work.

I generally don't do what the program says I should, and, indeed, I'm not too fond of the suggestions Grammatik makes; the program is a great deal better at finding problem text than fixing it. Still, it's very much worthwhile to have possible mistakes pointed out before you turn in work, whether it's a column or a term paper.

Microsoft's Schedule+

Windows has calendar and appointment-book software built into the operating en-

vironment, but Mac users have to buy one. Richard has found Microsoft's Schedule+ fairly valuable for keeping track of appointments and assignments.

Like the programs I've discussed this far, this is easy to learn. I haven't given Richard any computer lessons in five years, so he has learned to use all these programs on his own, and since he has almost no free time, anything he uses (other than games) must be useful. I know I wish I'd had a good schedule program when I was an undergraduate.

Voyager

One reason to have a Mac and a CD-ROM drive is Voyager's line of Music Appreciation Software. They have programs on Beethoven's Ninth Symphony, Mozart's Dissonant Quartet, and Schubert's *The Trout* Quintet, among others. The Voyager package consists of a good recorded performance of each work, hypertext commentaries giving background information on each composer and his life, detailed running commentaries on the music (including the score) as it's played, and that sort of thing. Warner has done much the same thing with *The Magic Flute*. Both

Voyager and Warner publish new titles every few months.

Voyager also has a series of books in hypertext. These don't need a CD-ROM player; indeed, they're adapted to run on a PowerBook portable. I have *The Complete Annotated Alice* and Michael Crichton's best-selling *Jurassic Park*. The notion is that you put the book on your PowerBook and you can read at odd times, just as you would from a book you'd carry. In addition, you get hypertext capabilities that let you jump around for additional information, some illustrations, maps, and definitions (e.g., scientific exposition on dinosaurs).

It's an interesting way to read a book. Alas, however, although most Mac software runs on every Mac there is, there are exceptions, and these extended books are one of them. They run only on Macs with 13-inch or larger screens.

Voyager is doing some wonderfully innovative things, much of it inspired by the capabilities of the Mac. Now that Windows is catching on, I expect to see some of the company's software for Windows machines. But for the moment, the Mac line really is ahead of PCcompatibles in

The CEO wants to know when it will be finished.

The staff wants to know when they can start.

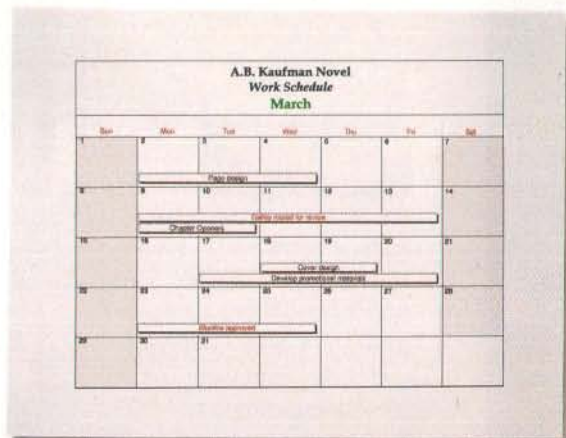
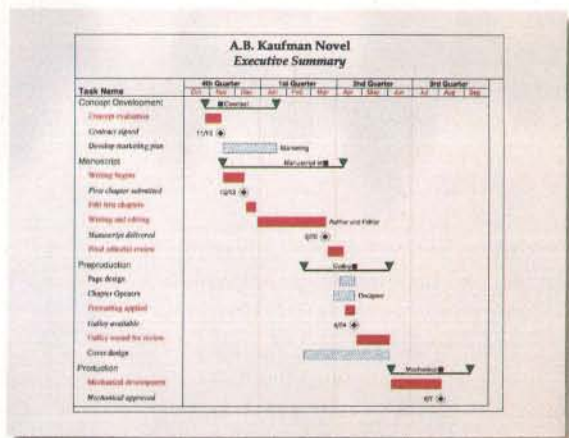

As a project manager, you've seen it all before. Everyone who needs to know, all too often, needs to know something different. Which is why there's new Microsoft® Project version 3.0 for Windows.™

It not only makes it easy to present

things the way *they* want, but also lets you plan things the way *you* want.

Now you can enter and view data in a variety of ways—Gantt's, tables, graphs, forms and more. Microsoft Project also has a customizable Toolbar,™ giving you access

bold new software concepts. (Amiga enthusiasts will point out that the Mac has yet to catch up to their machine; that's a story for another time.)

MacConclusions

The Mac is a good machine for students. Of course, that doesn't mean it's not a good machine for anyone else, but it's a particularly good machine for students, and particularly for students who have had little exposure to computers. The Mac is very easy to learn. I have observed that it takes hard work to get the most out of small computers, and that's as true for a Mac as for any other machine. However, a beginner can get more useful work done *right now* with a Mac than with a PC. Mac software is easier to use, and the Mac interface ensures that once you learn one piece of software, you're well along the way to learning all of them.

Up to now, that hasn't been true in the PC world. Windows is changing that, but it has only just begun that work. Of course, Windows is still only the most popular of a bunch of competing successors to the world of DOS and the uninformative C:> prompt.

I would argue that it takes about the same amount of work to become really proficient at either the Mac or the PC. The difference is that the PC learning curve is fairly steep at the beginning and then levels off at the intermediate stage; the Mac learning curve is more nearly constantly linear, so it takes a lot less effort to get to MacCompetence than to become a junior Power PC User.

We all know that beginning students have a lot of adjustments to make; learning to use a computer is one of them. It isn't the hardest of those adjustments, but it's nontrivial. Clearly, if a student is already used to a PC, it's probably better to send that student off with something familiar. But for those who have no previous knowledge of a machine, a Mac is a very good choice.

Another advantage to the Mac is that it's easy to add new peripheral equipment to it. When we wanted to upgrade the Quadra so that it sports both a large monochrome screen for page layouts and the normal-size color screen for everything else, we just installed the board and turned on the machine. The operating system understood that there were two screens in

place and knew how to handle that. With a PC, we'd have been forever trying to figure out interrupts, address spaces, and other nightmares.

The PS/2 Micro Channel machines aren't quite that brutal when it comes to adding peripherals. With those, you run a program that lets the machine do the work of figuring where things are to be addressed and what interrupts to employ. But, alas, the PS/2 Micro Channel isn't the way the third-party industry is going. IBM seems to have lost their marketing smarts on that one: companies that might well have been willing to pay a licensing fee for the Micro Channel have been scared off by IBM's attempts to use that as a screw to make them pay for cloning the old PC architecture. For whatever reason, not many third parties are developing hot new hardware peripherals for the Micro Channel. A PS/2 is probably not the machine to send off with your kid to college.

There remain expandable PCcompatibles, like the new Acer line; I'll get to those in another column. By and large, though, the Mac is a very good machine to send off to college. While most students would prefer either a PowerBook or the

The controller wants to know how much it will cost.

We want to know what you're waiting for.

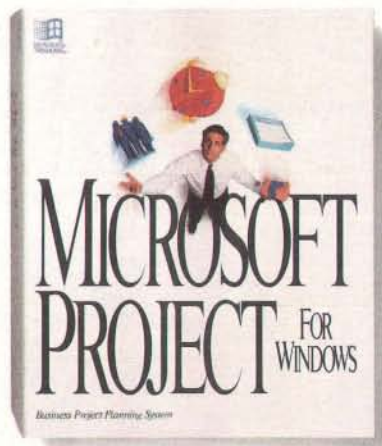
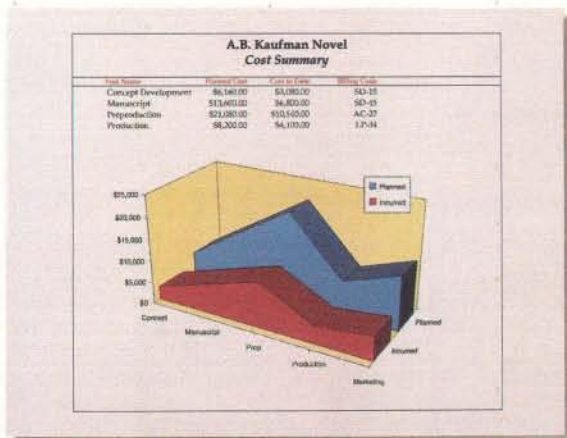

to the functions you use most with a click of the mouse. While PlanningWizards give you online assistance to help develop plans.

What's more, new Microsoft Project has WYSIWYG and Multi-Page Print Preview, so plan on visiting the printer less.

For your upgrade or the name of a reseller, call (800) 541-1261, Dept. X13. You'll satisfy a lot more people. Including yourself.

Microsoft
Making it easier

Just Add Code.

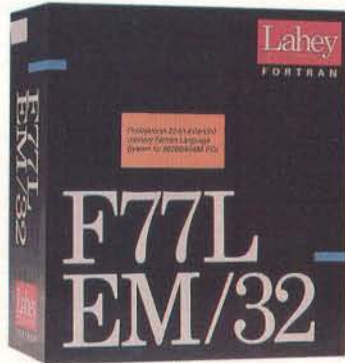

32-bit protected-mode Fortran

Your Fortran code is important. Trust it to the company that has been writing award-winning Fortran language systems for 25 years.

(800) 548-4778



Fortran is our forte

(702) 831-2500 ■ Fax: (702) 831-8123 ■ P.O. Box 6091 ■ Incline Village NV 89450

USER'S COLUMN

Mac II for the larger screen size, the Classic II is plenty good enough. I have no qualms about recommending it.

Printout Blues

The Moat Around God's Eye is 767,356 characters (about 128,000 words) long. You'll note that one figure is exact and the other clearly an estimate; a story goes with it.

Moat was written using Symantec's Q&A Write. I use the stand-alone version, while Larry Niven uses the one in the Q&A combination database and word processor package. Let me say at once that we're fond of the program. It has always been the easiest-to-learn word processing program of the lot. It's unobtrusive, putting little on the screen that you don't put there yourself, so the text area is clean and uncluttered. It's a character-based editor, which means you don't get WYSIWYG, but creative writers don't need that.

It's easy to set line lengths and margins, and it has a wonderful word-counting feature. At any time, you can press Control-F3 and up will pop a table showing the number of words, lines, and paragraphs before the cursor, after the cursor, and in the entire document. Since some writing assignments are measured by word count and others are by line count, this is a really useful feature.

Q&A Write has as good a search-and-replace program as any I know. It works nicely with both Definitions Plus (Word-Science's electronic version of *The American Heritage Dictionary*) and the Word Finder thesaurus from Microlytics loaded as TSR programs. This means I can, for instance, look up the meaning of *resident*, or find that I could substitute *lessee*, *occupant*, *intern*, or any of a dozen other words at the touch of a key. The Q&A Write spelling checker is pretty good, too. In a word, Q&A Write is more than just good enough for text creation.

Q&A Write is good enough for printing out letters and manuscripts of up to about 50 pages. It's fast, it knows how to use the HP LaserJet III font cartridges, and it allows reasonable headers and page numbers. Alas, it's plain lousy for printing out a book. Once the work gets longer than a single file (only about 50 to 75 printed pages at most), it's a real pain to get it to print with proper headers and page numbers.

There are three different versions of Q&A Write, and every one of them has a serious bug in its printing capability. The infuriating thing is that each version fixes one bug—only to introduce a worse one. The upshot is that while I can use Q&A Write to produce a submission manuscript

CELEBRATING OUR 10th YEAR WITH BYTE MAGAZINE

SUNDAY 10/5

<p>ALR Buss. Voice Mod. 101 386/33 MHz 5 MB 1.2 1.4 F/D 110 HD DOS 5.0 VGA 1874.99</p> <p>ALR Buss. Voice Mod. 101 486/33 MHz 5 MB 1.2 1.4 F/D 110 HD DOS 5.0 VGA 2094.99</p> <p>EMERSON 386 SX 1 MB 2 F/D 40 HD VGA 629.99</p> <p>MAGNAVOX 386 SX 20 MHz 2 MB 2 F/D 90 HD VGA 949.99</p> <p>MITAC 386 DX 33 MHz 2 MB 2 F/D 80 HD VGA 1324.99</p> <p>MITAC 486 DX 33 MHz 4 MB 2 F/D 120 HD Super VGA Non-integrated Monitor 1819.99</p>	<p>NOTEBOOK LAPTOP</p> <p>AST Premium Exec 386 SX 20 MHz 40 HD 25 MHz 4 MB 60 HD 1794.99 25 MHz 4 MB 90 HD 2349.99 25 MHz 4 MB 90 HD 2549.99</p> <p>AST Premium Exec Color 25 MHz 4 MB 60 HD 1674.99</p> <p>Everex Tempo Cartriv 386 SX VGA 20 MHz 60 HD 2094.99 2 MB 40 HD 2394.99 Mouse w/Windows 3.0 FREE</p>	<p>PRINTERS</p> <p>Canon BJ 350 259.99 Epson LQ 570 359.99 Epson LQ 670 594.99 Epson LQ 1070 960.99 Epson LQ 1170 239.99 Epson LQ 810 299.99 Epson 3250 24 Pin 414.99 Fujiitsu DL 1200 424.99 Olivetti 321 994.99 Olivetti 390 Plus 574.99 Olivetti 391 Plus 994.99 Panasonic KXP 1120 334.99 Panasonic KXP 1124 174.99 Panasonic KXP 1624 249.99 Panasonic KXP 1123 364.99 Panasonic KXP 2124 364.99 Panasonic KXP 7624 364.99</p> <p>220V PRINTERS</p> <p>Olivetti 380 259.99 Olivetti 321 494.99 Olivetti 390 Plus 784.99 Olivetti 400 1074.99 Olivetti Laser 800 1479.99 Olivetti Laser 830 1594.99</p>	<p>LASER PRINTERS</p> <p>Desk Jet 500 Color 699.99 Desk Writer HP Plus 749.99 HP Laser III 1449.99 HP Laser III 2284.99 HP Laser III 114.99 HP Laser III 234.99 1 MB Memory 299.99 2 MB Memory 699.99</p> <p>HP Laser 400 694.99 Olivetti Laser 600 894.99 Olivetti Laser 630 1294.99 Olivetti Laser 630 139.99</p> <p>SCANNERS</p> <p>HP ScanJet Plus w/HP Microfilm Color w/HP HP ScanJet II Color 1074.99 Lump Sum 1494.99</p> <p>MOUSE</p> <p>Logi Mouseport 59.99 Thompson Port 99.99 U.S. Ballpoint 124.99</p> <p>FACSIMILE (FAX)</p> <p>Canon Fax 40 404.99 Canon Fax 50 439.99 Pana. KXP-90 994.99 Pana. KXP-90 514.99 Pana. KXP-90 514.99 Pana. LP 1094 64.99 Pana. KXT 3520 76.99 Pana. KXT 3720 82.99 Pana. KXT 3720 144.99 Pana. KXT 3950 NEW 109.99 Pana. KXT 3910 129.99 Pana. KXT 4200 129.99 Pana. KXT 4300 129.99</p>
<p>NETWORKING</p> <p>Novell 2.2 User 1194.99 Novell 2.2 10 User 454.99 Network Lite 1849.99 Network Lite Starter 1894.99 Novell 3.11 20 User 129.99 Novel 5.0 80 User 124.99 Novel 5.0 16 User 329.99</p> <p>ARTISAT LANTANIC</p> <p>2 MBPS Starter 329.99 2 MBPS 100 User 444.99 10 MBPS V.4.1 Starter 194.99 10 MBPS V.4.1 100 User 129.99 3 Com 3C500 264.99 3 Com 3C500 16 B 264.99</p> <p>HARD DRIVES</p> <p>40 MB IDE 274.99 80 MB IDE 369.99 100 MB IDE 399.99 160 MB IDE 449.99 P/WinCard IDE 1054.99</p> <p>SOFTWARE</p> <p>Word F/Wind 2.0 119.00 Word F/Wind 2.0 Upgrade 259.00 W.P.F. Wind 79.99 W.P.F. Wind Upgrade 79.99 Fax Tool (FPL) J 175.99 Landscape (LW) 49.99 4.5 Wind 3.1 Upgrade 49.99</p>	<p>HEWLETT PACKARD</p> <p>PaintPro PC 95 512K 359.99 PaintPro PC 95 1K 1 MB 574.99</p> <p>Altec Portable 574.99 Power PC 512K</p> <p>TEXAS INSTRUMENT</p> <p>TW 3000 386 SX 20 MHz 1749.99 2 MB 40 HD 2094.99 2 MB 60 HD 2349.99 Win SX 4 MB 90 HD 2694.99</p> <p>TOSHIBA</p> <p>1.2000 SX 60 2049.99 1.2000 SX 80 2394.99 1.2000 SX 90 3349.99 1.3000 SX 80 5249.99 1.3000 SX 120 5249.99 1.4000 SX 80 (10) 4294.99 1.4000 SX 80 (10) 6349.99 1.8000 SX 2 6400.99 1.8000 SX 2 6400.99 1.8000 SX 2 6400.99</p> <p>PRINTERS F/LAPTOP</p> <p>Canon BJ 10 304.99 Citizen NP 48 299.99 Dixons 180 S 204.99</p>	<p>MONITORS</p> <p>NEC MultiSync 3 Flat 259.00 NEC MultiSync 4 FG 494.99 NEC MultiSync 5 575.00 Sony CPX 1304 309.99 Panasonic 1395 414.99</p> <p>EXECUTIVE ORGANIZER</p> <p>Canon SF 4500 326K 99.94 Canon SF 6000 640K 144.99 Canon SF 6500 640K 194.99 Sharp FO 5200 64K 174.99 Sharp FO 7620 64K 229.99 Sharp FO 8300 128K 299.99 Sharp OZ 8000 128K 314.99 Sharp OZ 8400 256K 314.99</p>	

IN USA & CANADA & P.R. INCLUDING NY STATE

1-800-874-1235

S & W COMPUTERS & ELECTRONICS

31 West 21 Street, New York, NY 10010

NYC (212) 463-8330

Mon.-Thurs 9-6 Fri. 9-1-45
Saturday Closed

• DISCOVER • M.C. VISA C.O.D. w/Depo. • No surcharge for credit cards. Ship. Addtl. Handling 2% (NY, LI, NJ). Prices subject to change. Returns w/ written authorization. Free Parking. Sunday. Meet. Parking available. Prices for consumers.

PRICES HARD TO MEET — SERVICE HARD TO BEAT! World Wide Inquiries Promptly Filled

You want an accelerator that makes your Windows™ go *vrrooom*.

You also want color that makes your eyes go *boing*.

And you want a deal that makes your mind go

whoop-dee-doop-zang-zowieee.

Cool.



Super VGA and a Windows accelerator
all on the same card.

For more information call
Western Digital at 714-932-4900.

Paradise and Western Digital are registered trademarks of Western Digital.
All other marks mentioned herein belong to other companies.

 **PARADISE**[®]
Western Digital Corporation

Circle 174 on Inquiry Card (RESELLERS: 175).

of my books, it's a real pain to do that.

Our agent asked for three copies of *Moat*, one to be sent via Federal Express as soon as possible. Those needed to be double-spaced. Roberta and Marilyn Niven both needed reading copies. Those would have 1½ spaces between lines. I'd need a master copy on which we could record editorial suggestions: double- or triple-spacing for that. It all had to be done over the weekend.

The prospect of using Q&A Write to

produce five or six copies of a 490-page book was thoroughly daunting. Time, I figured, to try something else.

Alternatives

One possibility would be to use LapLink Mac to convert the book into a Mac file, read it into Aldus PageMaker, and print it with that. It would be fast and would come out beautifully. However, I'm not very familiar with PageMaker. Roberta uses it to produce the Opera League newsletter, but

I haven't had much experience with it. Worse, though, I'd end up with a printout file I couldn't really edit and the book split between two machines.

There had to be another way.

I had recently received a copy of Microsoft Publisher for Windows. This seemed to have good layout capabilities—nothing like all the features of PageMaker, but enough for what I needed. However, when I looked through the manuals, there wasn't much about books and running heads of chapters. Microsoft Publisher is clearly intended for shorter things, like illustrated newsletters. Indeed, I like it enough that I am very likely to transfer to Publisher my "generic letter" that I send with my replies to BYTE mail. I'll have more on Publisher in an upcoming column; it has some excellent features. It's just not the right tool for printing a 490-page manuscript.

Ami Pro was another choice. Many of my friends swear by it. Alas, the version of Ami Pro I have was installed before I installed Windows. When I later installed Windows (and then updated the Windows installation several times with different versions of Windows 3.1), it must have done something to Ami Pro, because the program won't read in files any longer. An attempt to reinstall Ami Pro produced the message that my print drivers were obsolete and I should get new ones. I gather I have a fairly old version of Ami Pro. I'll get an update, but I sure wouldn't be using Ami Pro over the weekend.

Word for Windows

I also had a brand-new copy of Microsoft Word for Windows. Many people swear by Word, and I'm told that Word for Windows is even better. Chaos Manor has pretty well converted over to Windows 3.1, and the more work I can do with Windows programs, the better, so Word for Windows was an obvious choice.

Word for Windows can import several foreign file formats. It specializes in crushing WordPerfect (you can even configure Word for Windows to use WordPerfect keyboard commands). Alas, it never heard of Q&A Write.

That, however, was no problem, because Word for Word Professional from Mastersoft will convert files from Q&A Write to almost anything. Word for Word is simple to use; I've never had to bother with the manual. It will take wild cards for input and output, so all I had to do was tell Word for Word the input and output formats, put all the chapters of *Moat* into a single subdirectory, create an output subdirectory, and tell Word for Word to convert *.QW files to *.DOC files. The whole

Put an end to software piracy!

Meet the growing family of security keys from Software Security.

Each one a specialist at enforcing your license agreement in virtually any user environment you can think of. Whether it's DOS, UNIX, Macintosh or OS/2...whether it's a single user installation or a LAN.

Simply connect the appropriate key to a single user computer, or a non-dedicated file server in a network, and you control all access to your protected application.

Users, however, won't even know it's there. The keys are transparent and won't impact software functionality or the ability to make back up copies. Normal node and LAN operations are unaffected.

Simple. Unassuming. Ever vigilant. Easy to incorporate into your application package. And quite possibly the most profitable hardware investment a software developer can make.

To find out more, call: **1-800-333-0407**

IN CONNECTICUT CALL: 203-329-8870

FAX 203-329-7428

EUROPE AND UK: +44 784 43 00 60



SOFTWARE SECURITY INC.

1011 High Ridge Road
Stamford, CT 06905

Proudly Made in the USA

THE ULTIMATE PROTECTION FOR SOFTWARE PUBLISHERS

North American Readers circle 307
Other Readers Worldwide circle 308
on Inquiry Card.

All product names are trademarks or registered trademarks of their respective holders.

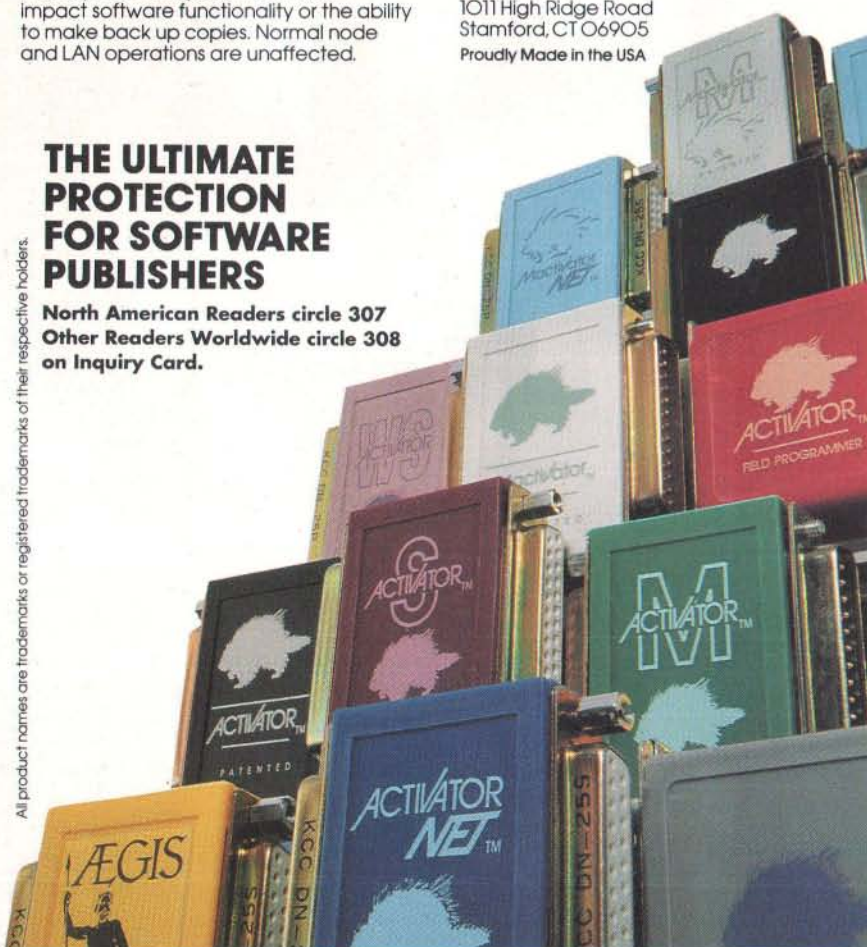

ATLAS SOFTWARE

A NEW DIMENSION IN DATA MANAGEMENT

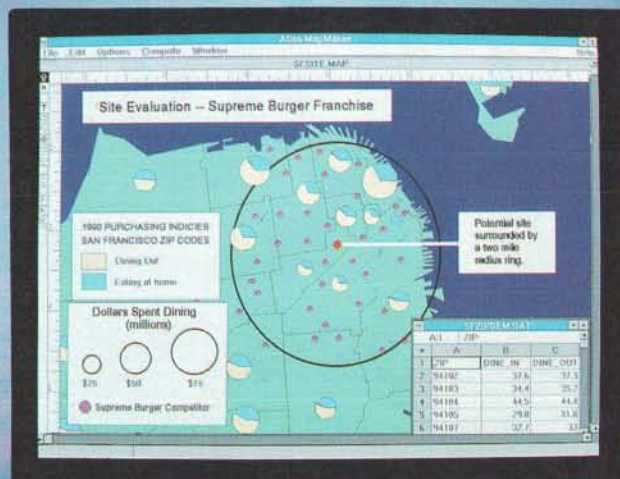

M

ost business and government professionals view and analyze data with spreadsheets, databases and occasionally in business graphics packages. While these types of software work well when displaying statistical data, they are blind to important geographical information — such as market potential by sales territory, distribution coverage by product, or customer locations by ZIP code or street address.

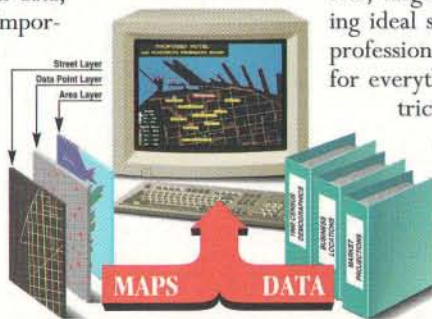

Atlas Software™ is changing that. By linking data from spreadsheets, databases and even other applications — on your PC or Macintosh® — you can now add the important geographical dimension to your information system.

And when we say important, we mean mission critical. For example, *Atlas Software* can help business professionals answer “what if” and “show me where” questions for optimizing sales territories, targeting customers, and selecting ideal site locations. Government professionals can use *Atlas Software* for everything from political redistricting to land-use planning and public safety analysis. Without *Atlas Software* decision makers often overlook important geographic information and allocate resources ineffectively.

Atlas Software programs come equipped with built-in data management capabilities, map file importing and a generous

base map and data sampler from our comprehensive library containing over 75 gigabytes of geographic files, business statistics and demographic data.



Atlas Software comes in a variety of “flavors” to suit your specific needs and supports MS DOS®, MS Windows® and Macintosh operating systems.

So if you're ready to add a dynamic new dimension to the way you use information, like 25,000 other Strategic Mapping customers, call us for a free *Desktop Mapping Guidebook* and demo disk. We'd be happy to map out a plan for you.

Phone: (408) 985-7400
FAX: (408) 985-0859

In Canada, call 416-693-4166
In the UK, call 44-81-994-2780

In Germany, call 49-228-62-73-82
In Australia, call 61-3-866-1766



In Belgium/LUX, call 32-2-771-25-75
In France, call 33-1-45-27-20-61
In the Netherlands, call 31-340-266-336
In Denmark, call 45-42-25-17-77

Circle 157 on Inquiry Card.

Soon, Eight Hours Computing Will



(actual size)

AMD Introduces The World's First 386 Microprocessor With 3-Volt Technology.

Two standard dry-cell batteries. There's really nothing special about them. Aside from the fact that they can run a powerful, portable 386 computer for a full eight hours. Provided, of course, that portable is built around a low-voltage Am386™ microprocessor.



The 25MHz DXLV and the 25MHz SXLV are available in POFP packaging.

Thanks to the low-voltage Am386 microprocessors, laptop, palmtop and notebook computer designs will become smaller, lighter, and more powerful than ever before.

With battery life of up to eight hours or more. That's a full day's worth of 386 performance—the per-

urs Of Portable Look Like This.

formance you need to run sophisticated applications like Windows™ 3.0.

And rest assured, the low-voltage Am386 microprocessors are proven compatible and comply fully with JEDEC standards for low-power, 3-volt computing. We can even supply you with the 3-volt EPROMs your systems will need. Other 3-volt system logic is also readily available.

For more information on the low-voltage

Am386 microprocessors call AMD today at **1-800-222-9323**. You'll never look at dry-cell batteries the same way again.



Advanced Micro Devices

"We're Not Your Competition."™

thing, including the conversions, took under 5 minutes.

I'd previously installed Word for Windows. The interface is reasonably intuitive, although there are some conventions better conveyed by folklore than learned from the manuals and tutorials. A little mousing around showed how to bring in the 29 chapters of *Moat* one at a time, set the headers, set the typeface (on advice, I chose 12-point CG Times, a printable Windows font, as the main font), reformat to double spacing, and save it off. It was a snap, with the whole job done in under half an hour.

There was one immediate glitch: when I would read in the file, Word for Windows told me there were 767,356 characters and 135,000 words; the word count was in gray, indicating that it was an estimate. The statistics "windowlet" has an "update" button; clicking on that caused the program to trundle for a while and then proudly announce a total of 60,273 words; which, of course, was absurd. The average English word is five characters and a space; dividing the character count by 6 gives an estimate of 128,000 words.

I also have a word-count shareware pro-

gram (several are available on BIX) that very speedily counts words in one or many files. It wasn't a big problem, but it was annoying. I've since learned, though, that all I needed to do was add 65,535 to the total shown. Word rolls over at that number.

The word count problem was annoying, but worse was in store.

LPT1 vs LPT1.DOS

Editing with Word for Windows is simple and intuitive. I'd say it was "Mac-like" except that, having used Wirth's Lilith before I ever saw a Mac, I'd prefer to say it's "Xerox-PARC-like." I'm still not used to black letters on a white background. From the earliest days, I've used a dark background and light letters for writing. Still, I could get used to it. Word for Windows is fast, and while I haven't used it much for text creation—I'm writing this with Q&A Write—I expect that I could grow to like Word for Windows a lot. If you're looking for a new text editor, this is a good one.

Once I had the text formatted properly, I pushed the print button. The program told me it was printing, but nothing was happening at the printer. That, of course, is

because I had the Windows Print Manager turned on. Under Print Manager, a program first "prints" to a disk file, and only after the entire file is spooled onto the disk does any actual printing take place. This meant that before any printing began, I had the machine tied up for quite a bit of time. Eventually, though, it was done. The LaserJet III whirred—and then garbage came out.

There was nothing wrong with the printer. I could tell Q&A Write to print (running as a DOS program under Windows) in Times Roman, and it did that fine. But when I told any Windows program whatever to print in any font whatever, the result was garbage.

In despair, I used Q&A Write to print one copy of *Moat* and got that off to our agent. Then I got on BIX, explained the problem in my conference ("tojerry/queries"), and waited. Within an hour, I got a note from Jeff Sloman suggesting I call him. I did, and for an hour I experimented while the phone remained surgically attached to my ear.

We tried a lot of things. What fixed it was to go into the Control Panel, open the Printers icon, open the "connections" box,

What's Your Problem?

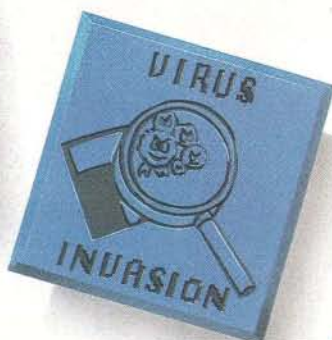

When in Doubt, Check It Out!

When you have a PC problem, you need to know if the cause is hardware, software, or something else. Check✓It quickly identifies the cause of PC problems or verifies that your PC is working correctly, saving you time, money, and unnecessary repair calls.

Check✓It shows you:

- PC Configuration Details
- DOS Setup Data
- IRQ Assignment Conflicts
- Bad Memory Chips
- Hard and Floppy Drive Testing
- Serial Parallel Port Errors
- Complete Virus Scan

Call us TODAY to
Check✓It Out for yourself:



TouchStone

Software Corporation

2130 Main Street Huntington Beach, CA 92648
(800) 531-0450 or (714) 969-7746

The World's Best Selling UNIX Clone Just Got Better.

Now with full 32-bit implementation!

If you want to ignite your 32-bit hardware with the multi-user, multi-tasking power of UNIX, Coherent 4.0 has arrived. And if you're operating or selling small business network systems with dozens of users, that's really good news. Because Coherent 4.0 is what you want in UNIX at a price that's hard to believe.

Run UNIX applications today!

Coherent is now binary compatible with UNIX. Most UNIX PC applications port with a simple recompile and many now run right out of the box. The list is growing everyday, so call for details.

Yes, It's For Real!

How can it be? First of all, Coherent was independently developed by the Mark Williams Company, so you don't pay for UNIX licensing fees. You don't pay any mark-up or reseller costs either. Coherent is only sold directly to you.

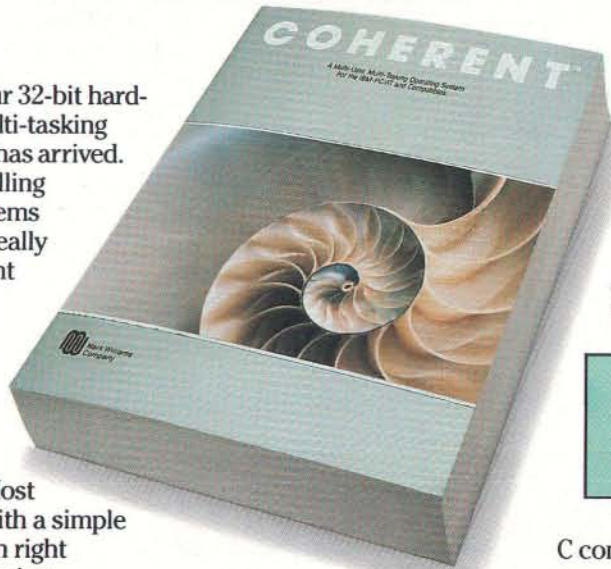

six disk installation is a breeze compared to their 25. You'll also learn it faster and increase overall performance. All because Coherent is smaller, faster... and better.

Small, But So Complete.

Make no mistake, Coherent is a wholly professional development system. You get a complete

"Coherent comes so fully qualified as a UNIX clone, you find yourself thinking, 'I can't believe it's not UNIX:'—Sean Fulton, UNIX Today!"

C compiler, assembler and over 200 UNIX commands including full sets of functions for development, administration, maintenance and text processing.

Coherent also comes with UUCP capabilities that connect you to a world-wide network of free software, news and millions of UNIX users. And it's all clearly documented in Coherent's highly praised 1200 page manual.

Experienced, Supported, Guaranteed.

Mark Williams Company has been developing professional programming tools since 1976. Our commitment to our products and users is unsurpassed. Users applaud our popular BBS and the widely acclaimed telephone support they get free from Coherent developers.

Still, we're not asking you to take a chance on Coherent. We've made it fool-proof to see for yourself—with a 60-day money-back, no hassles guarantee. So pick up that phone and order Coherent now. And the best way to UNIX will be on its way to you!

800-MARK WMS

(800-627-5967 or 708-291-6700, FAX: 708-291-6750)

60-DAY MONEY BACK GUARANTEE!



Mark Williams Company

60 Revere Drive, Northbrook, IL 60062

Coherent is a trademark of Mark Williams Company. UNIX is a trademark of USL.

Coherent.™ Still \$99.95.

	MWC COHERENT Version 4.0	SCO UNIX/386 Version 3.2V2
No. of Manuals	1	14
No. of Disks	6	25
Kernel Size	100 K	375 K
Install Time	40 min.	3-4 hours
Suggested Disk Space	10 meg	60 meg
Min. Memory Required	1 meg	2-4 meg
Performance*	85.7	31.3
Price	\$99.95	\$2590

*Byte C Compiler Benchmark: Compiles per minute on 25 MHZ 486.

"... (Coherent) may be the best thing that has happened to UNIX yet."
—William Zachmann, PC Week

In fact, over 40,000 copies of Coherent have already been sold. And, like the ones we quote here, virtually every critic who's reviewed Coherent has raved about it.

So Much Less, Yet So Much More.

As a virtual clone of UNIX, Coherent embraces the original UNIX philosophy: Small is beautiful. Small price, yes. But there's more, much more, to Coherent than its amazing price.

Requiring only 10 megabytes of disk space, Coherent can reside with DOS. So you can keep all your DOS applications and move up to Coherent. And it runs with as little as 1 MB of memory versus 4 MB for other UNIX versions.

The World's Only Plug And Play UNIX Clone.

You'll have Coherent up and running with a fraction of the time and effort it takes for other UNIX versions. Our

and change the default printer connection from LPT1 to LPT1.DOS. This has the effect of taking Windows out of the picture, so to speak; that cured the problem.

As I write this, neither I nor anyone else knows why I have to print this way; on the other hand, I haven't experienced any problems.

I then had a perfect orgy of printing: Word for Windows and the LaserJet III print 290 pages single-spaced, or about 500 pages double-spaced, formatted in 12-

point CG Times, in a little over an hour. No attendance was needed, other than making sure that the paper bin was kept filled.

I still don't know why I had to change the connections, but Windows, Word for Windows, and the LaserJet III are a winning combination. I never had a nicer-looking manuscript.

But I have a potentially better combination: the LaserMaster system, which turns the LaserJet III into a very high

speed, high-resolution printer. That, alas, must wait until next month.

Winding Down

This is ridiculous: I have about a million things piled up that I need to write about. I have the NEC MultiSync 4FG monitor that, with an antiglare filter, is plain wonderful; highly recommended, a clear User's Choice Award for performance for the money.

I also have a Nanao FlexScan T560i monitor. It doesn't need an antiglare filter. I have it on my desk facing a south window, and it doesn't give me any eye trouble at all. The FlexScan is nothing like cheap, but it's wonderful. I never had a better monitor. It's so steady it seems like the images are painted on, and the colors are beautiful.

I have software overflowing in all directions. I have Corel Blockbuster, a SCSI board and CD-ROM drive packaged with Corel software. It all has to wait.

The book of the month is actually an author: Terry Pratchett. We get early copies of his books from England, so I'm not sure which ones are available here and which are not. If you see a Terry Pratchett book you haven't read, buy it with confidence. Pratchett writes comic fantasy. Sort of. It's funny with a twist. Try it; you'll like it.

The computer book of the month is Michael Hyman's *Windows 3.0 for BASIC Programmers* (Addison-Wesley, 1992); it gives good insights into how to do things with Windows and Realizer.

The game of the month is *The Secret of Monkey Island II*, in which the wicked pirate is avenged.

The exciting news from the CD-ROM Conference was the miniature Sony CD-ROM player and the upcoming Microsoft multimedia viewer that uses it. Next month, that, new CD-ROMs, and some observations on what's happening to the computer industry during the recession. Now I'm off to a program review of the SSX single-stage-to-orbit spaceship. With luck, it will fly in a year. ■

Jerry Pournelle holds a doctorate in psychology and is a science fiction writer who also earns a comfortable living writing about computers present and future. Jerry welcomes readers' comments and opinions. Send a self-addressed, stamped envelope to Jerry Pournelle, c/o BYTE, One Phoenix Mill Lane, Peterborough, NH 03458. Please put your address on the letter as well as on the envelope. Due to the high volume of letters, Jerry cannot guarantee a personal reply. You can also contact him on BIX as "jerryip."

P E R I S C O P E

JUST RELEASED

Model IV for 386SXs

OS/2 Driver Support

32-Bit Toolkit

Rent Model IV

Windows 3
Driver
Support

Professional Software and Hardware-Assisted Debuggers for 80386 & 80486 Systems

If you need a debugger but have no room left in the lower 640K of your 386™ or 486™ system, Periscope now has a new SOFTWARE-ONLY solution for you—Periscope/EM.

- Periscope/EM takes advantage of the extended memory you already have, rather than using any memory in the lower 640K.
- No runaway program can corrupt Periscope/EM because it's write-protected.
- You don't have to use a slot since there's no board to install.
- You can add an optional break-out switch to recover from crashes.
- Periscope/EM costs only \$295, half the cost of Periscope Model I, with most of the same functionality.

Periscope/EM requires 386MAX® or BlueMAX™, version 5.11 or later; a 386 or 486 system with about 300K of extended memory; 32K of memory between 640K and one megabyte; DOS 3.0 or later.

New Debugging Tools

"I needed a means to debug interrupt handlers where I could really see what was going on. The hardware trace buffer is great. I was able to debug code in 3 days that I have been trying to debug for months!"

...writes Peg Sestrich with Prime Computer, on why she chose Periscope Model IV.

If you need more than your current software-based debugger gives you, Periscope Model IV, with these advanced NEW features, may be just what you're looking for:

- Supports 386 and 486 systems running up to 33MHz with its ICE-like capabilities.
- Real-time hardware trace buffer holds up to 16K CPU events.
- Enhanced analysis and display of trace buffer makes you more productive.
- Periscope/EM functionality, built-in at no extra cost, saves you money.

Just call toll-free 800/722-7006 for details or to order.

The Periscope Company, Inc.

1197 PEACHTREE ST.
PLAZA LEVEL
ATLANTA, GA 30361
404-875-8080
FAX 404-872-1973

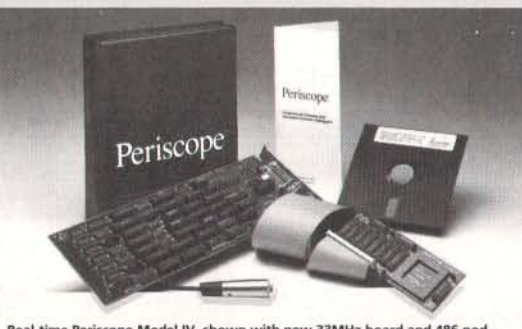

Real-time Periscope Model IV, shown with new 33MHz board and 486 pod.

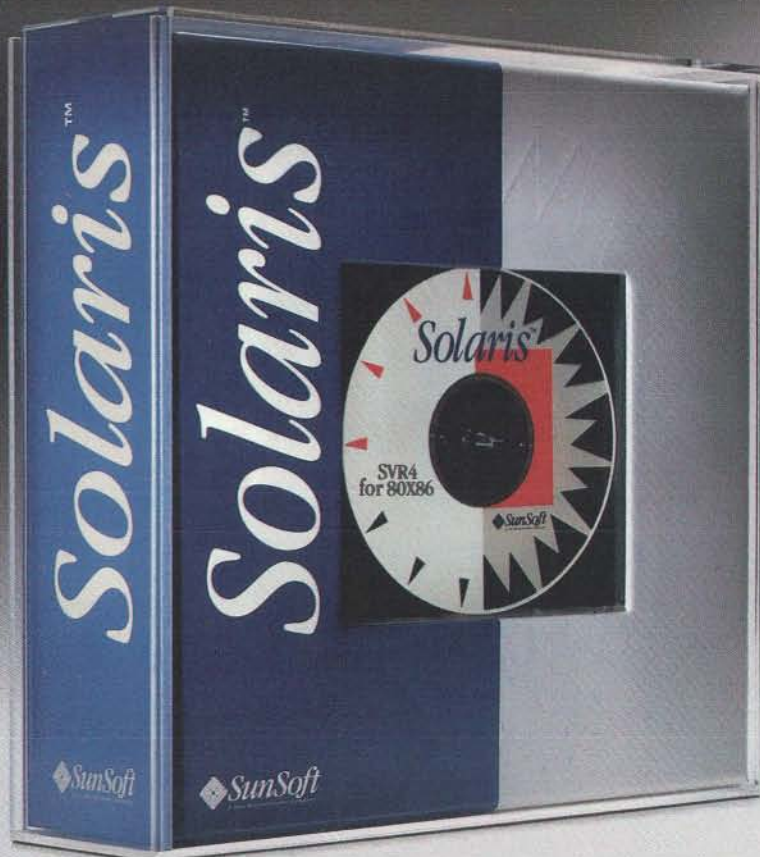

To Get There, Start Here.

Introducing INTERACTIVE UNIX From SunSoft.

While the 80386 microprocessor swept in the age of 32-bit hardware, most users have been forced to use 16-bit system software. Until now. Enter SunSoft, with the answer to your 32-bit question: INTERACTIVE UNIX® system software, the fastest growing 32-bit software solution for 80X86 computers. And the path to the Solaris® 2.0 distributed computing solution with SVR4 for Intel-based systems.

Here Today.

INTERACTIVE UNIX 3.0 transforms your under-utilized 386/486 computers into 32-bit, turbo-charged powerhouses, providing an easy to use, multitasking, multiuser environment today—not years from today.

It runs thousands of UNIX and Xenix applications and most of your favorite DOS applications. With award-winning windows technology, INTERACTIVE UNIX is as easy to use as a PC.



And pop-up menus combined with context-sensitive hypertext help eliminate the challenge of system administration and installation.

The Path To Solaris 2.0 With SVR4.

INTERACTIVE UNIX from SunSoft provides a path to the future of distributed computing: Solaris 2.0. A future that is based on SVR4.

Multiprocessing. Multithreading. The 3D OPEN LOOK® graphical user interface. An object-oriented environment. Heterogenous networking. A future that unites the most widely used RISC and CISC architectures. And your INTERACTIVE UNIX applications will run on Solaris 2.0.

From Here To There For Only \$195!

We're making it even easier to get from here to there. If you purchase INTERACTIVE UNIX 3.0 in any of its configurations before June 30, 1992, registered users will receive a \$195 promotional offer for Solaris 2.0 on 80X86 based systems. So enhance your productivity, power and future with one simple call: 1-800-227-9227. See you there.

 **SunSoft**
A Sun Microsystems, Inc. Business

Supported configurations are limited. Call for system requirements and further details. Promotional price applies to only one copy for each qualifying purchase. Resellers not eligible. Void where prohibited. Subject to availability. Promotion may end at anytime. ©1992 Sun Microsystems, Inc. All rights reserved. Printed in the USA. Sun, Sun Microsystems, the Sun logo, SunSoft, and Solaris are trademarks or registered trademarks of Sun Microsystems, Inc. INTERACTIVE UNIX is a registered trademark of the Kodak Company. UNIX is a registered trademark of UNIX System Laboratories, Inc. Intel is a registered trademark of Intel Corporation. SPARC is a registered trademark of SPARC International, Inc. Products bearing SPARC trademarks are based upon an architecture developed by Sun Microsystems, Inc.

Circle 190 on Inquiry Card.

ITEMS DISCUSSED

Ami Pro 2.0.....\$495
 Lotus Development Corp.
 Word Processing Division
 5600 Glenridge Dr.
 Atlanta, GA 30342
 (800) 831-9769
 (404) 851-0007
 fax: (404) 255-9460
Circle 1178 on Inquiry Card.

DeskWriter HP 2279A.....\$599
 Hewlett-Packard Co.
 3000 Hanover St.
 Palo Alto, CA 94304
 (800) 752-0900
 (415) 857-1501
Circle 1179 on Inquiry Card.

FlexScan T560i.....\$2699
 Nanao USA Corp.
 23535 Telo Ave.
 Torrance, CA 90505
 (800) 800-5202
 (310) 325-5202
 fax: (310) 530-1679
Circle 1180 on Inquiry Card.

14.4EX.....\$699
 Intel Corp.
 Personal Computer Enhancement
 Operation
 5200 Northeast Elam Young Pkwy.
 Hillsboro, OR 97124
 (503) 696-8080
Circle 1181 on Inquiry Card.

Grammatik IV 2.0
 IBM, Mac, and Unix\$99-\$495
 network\$245-\$495
Grammatik IV for Windows.....\$99
 Reference Software International
 330 Townsend St., Suite 123
 San Francisco, CA 94107
 (800) 872-9933
 (415) 541-0222
 fax: (415) 541-0509
Circle 1182 on Inquiry Card.

Mac Classic II
 with 4 MB of RAM and
 an 80-MB hard drive.....\$1849
 Apple Computer, Inc.
 20525 Mariani Ave.
 Cupertino, CA 95014
 (408) 996-1010
Circle 1183 on Inquiry Card.

Mac RAM.....(call for prices)
 Technology Works
 4030 Breaker Lane W, Suite 350
 Austin, TX 78759
 (800) 688-7466
 (512) 794-8533
 fax: (512) 794-8520
Circle 1184 on Inquiry Card.

**Microsoft Publisher for
 Windows**.....\$199
**Microsoft Word for
 Windows 2.0**.....\$495
**Microsoft Word for
 Macintosh**.....\$395
Microsoft Works.....\$149
**Microsoft Works for
 Macintosh**.....\$249
Schedule+ for Macintosh.....\$195
 Microsoft Corp.
 1 Microsoft Way
 Redmond, WA 98052
 (800) 426-9400
 (206) 882-8080
 fax: (206) 883-8101
Circle 1185 on Inquiry Card.

MultiSync 4FG.....\$899
 NEC Technologies, Inc.
 1414 Massachusetts Ave.
 Boxborough, MA 01719
 (800) 632-4636
 (508) 264-8000
 fax: (508) 264-8673
Circle 1186 on Inquiry Card.

**Music Appreciation Software:
 The CD Companion**
Series.....\$59.95-\$99.95
**Books on floppy disks in
 Mac hypertext format**.....\$19.95
 The Voyager Co.
 1351 Pacific Coast Hwy.
 Santa Monica, CA 90401
 (800) 446-2001 (orders)
 (310) 451-1383
 fax: (310) 394-2156
Circle 1187 on Inquiry Card.

**PageMaker for the
 Mac 4.2**.....\$795
**PageMaker for Windows 3.0
 version 4.0**.....\$795
 Aldus Corp.
 411 First Ave., Suite 200
 Seattle, WA 98104
 (800) 333-2538
 (206) 628-2320
Circle 1188 on Inquiry Card.

Q&A Write.....\$199
Q&A 4.0.....\$399
Network Pack.....\$499
 Symantec Corp.
 10201 Torre Ave.
 Cupertino, CA 95014
 (800) 228-4122
 (408) 253-9600
 fax: (408) 253-4092
Circle 1189 on Inquiry Card.

Scanners.....\$299-\$599
 Logitech, Inc.
 6505 Kaiser Dr.
 Fremont, CA 94555
 (800) 231-7717
 (510) 795-8500
 fax: (510) 792-8901
Circle 1190 on Inquiry Card.

**The Secret of
 Monkey Island II**.....\$59.95
 LucasFilm Games
 P.O. Box 10307
 San Rafael, CA 94912
 (800) 782-7927
 (415) 721-3300
Circle 1191 on Inquiry Card.

SP-2000AP.....\$239
 Seikosha America, Inc.
 10 Industrial Ave.
 Mahwah, NJ 07430
 (800) 338-2609
 (201) 327-7227
 fax: (201) 818-9075
Circle 1192 on Inquiry Card.

**Word for Word
 Professional 5.0**.....\$149
 Mastersoft, Inc.
 6991 East Camelback Rd.,
 Suite A320
 Scottsdale, AZ 85251
 (800) 624-6107
 (602) 277-0900
 fax: (602) 970-0706
Circle 1193 on Inquiry Card.

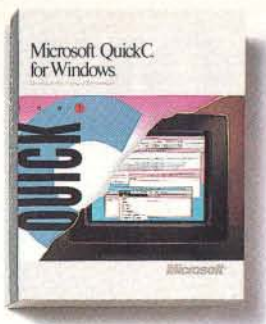

Graphic proof that developing Windows apps is now easier.

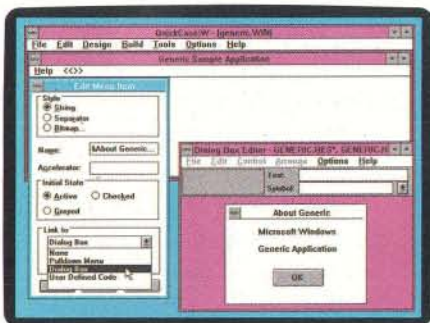

Use QuickCase:W to draw the graphical elements of your Windows program, from menus and dialog boxes to cursors and icons. Then, let QuickCase:W generate commented expert-level C source code for the design that you've created.

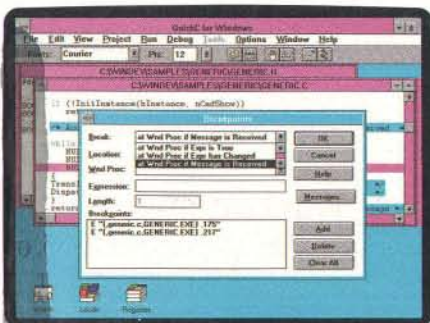

QuickC for Windows supports a wide range of breakpoint types, from breaking at a location to breaking on a Windows procedure when a message is received.

Take a look at Microsoft® QuickC® for Windows™. It's Windows-hosted, so you can edit, compile, and debug inside a single environment. Click on the Toolbar™ to choose frequently-used functions, from changing fonts to setting breakpoints. Workspace templates let you save your screen layouts, so you can reload them quickly from another session.

Plus, a remarkable tool known as QuickCase:W lets you create every element in your user interface with a few strokes of a mouse. Then it automatically generates the C source code you need.

All of which lets you create more applications. And more kinds of applications: C programs that call Windows APIs, graphical front-end programs for FORTRAN and COBOL, and C DLLs for other programs.

We suggest a visit to your Microsoft dealer. Because with QuickC for Windows, seeing is believing.

© 1991 Microsoft Corporation. All rights reserved. Printed in the U.S.A. Inside the 50 United States, call (800) 541-1261, Dept. V75; outside the 50 United States, call (206) 936-8661. In Canada, call (416) 568-3503. Microsoft, CodeView, MS-DOS, QuickC and the Microsoft logo are registered trademarks and Windows, and Toolbar are trademarks of Microsoft Corporation. *As used herein, "DOS" refers to MS-DOS and PC-DOS operating systems.

PROGRAMMER'S TIPS

Key Features

- Windows-hosted integrated development environment including an editor, compiler, and debugger.
- All you need to write a Windows-based program.
- QuickCase:W generates source code from your program design and regenerates the code if you change the design.
- Wide range of breakpoint support, including breaking at a location, breaking when an expression has changed, and breaking at a Windows procedure when a message is received.
- Complete printed and online documentation on the Windows API.

- Toolbar for quick access to frequently used editing and debugging functions.
- Save Workspace and Load Workspace for saving and restoring window positions and breakpoints.
- Syntax highlighting in editor.
- Customizable tools menu allows you to run any Windows or DOS* program from within the QuickC for Windows environment.
- QuickWin library for converting well-behaved C programs for DOS to Windows programs.
- Generates Windows Executables, Windows Dynamic Link Libraries, QuickWin Executables for the Windows environment, and MS-DOS* Executables.

- To rebuild your character-based DOS applications to run under the Windows environment, select the "QuickWin EXE" Project type in the Options menu.
- Use the new and improved Dialog Editor to quickly and easily design dialog boxes for your programs.

Microsoft
Making it easier

"The Best Memory Manager"

It's an easy claim to make, but we have the facts to back it up:

Our new QEMM-386 version 6 is the best way to get the most out of memory. It 'pools' all your memory so that it's available in whatever form your programs need—

"It's nothing less than a dream come true"
—Steve Gibson InfoWorld 8/26/91

expanded or extended. You don't even need to know the difference. QEMM does it all for you. Instantly. Whereas DOS 5, for example, requires you to figure out what you need, then manually allocate memory and re-boot every time you need to change.

As for the all-important 'conventional' memory area, our new version 6 increases the amount of memory freed-up. Our exclusive 'optimize' feature automatically seeks out TSRs and device drivers and moves them into high memory—the area between 640K and 1 megabyte. All you need do is type 'OPTIMIZE'.

PC Week Ratings	All Charge 386 3.2	Netroom 2.10	QMAPS 2.0	386Max/BlueMax 6.00	QEMM 6.01 Analyst's Choice	Memory Commander 2.1
Software Compatibility	●	●	●	●	●	●
Hardware Compatibility	●	●	●	●	●	●
Reliability	●	●	●	●	●	●
Ease of Use	●	●	●	●	●	●
Memory Management Flexibility	●	●	●	●	●	●
Quality of Documentation	●	●	●	●	●	●

● GOOD ● SATISFACTORY ● NEEDS IMPROVEMENT
PC Week rated QEMM 6 the best memory manager.



Our latest awards.

QEMM-386 v6 finds more high memory than any other memory manager. *Byte Magazine's* tests showed it produced net memory gains of 21K to 132K over DOS 5.0 alone, for instance.

Stealth takes you to network and TSR heaven.

Our breakthrough 'Stealth' technology makes available areas normally taken up by ROM. Areas that QEMM-386 can use to load memory-hogging drivers and TSRs. Big programs can get the memory they need to run fast and efficiently. And you get to have your TSRs.

Not every PC can benefit from Stealth. But every PC can benefit from



'Squeeze'—our new feature to accommodate those TSRs that need more memory at start up and less when they're resident. Memory allocation is temporarily increased, then squeezed down after it's needed.

QEMM can use idle video memory to produce a further 96K gain on EGA and VGA systems when running character-based programs.

A priceless \$60 bonus.

QEMM comes with Quarterdeck Manifest, the award-winning analysis program that shows what's going on 'under the hood' of your PC.

Manifest does for memory what Norton Utilities does for disks.

Big Benefits for Windows users, too.

Whether you're running DOS 3, 4, 5, or Windows, QEMM can improve your 386/486's performance.

That means you may not need a faster CPU. You may not even need more RAM. QEMM makes your favorite programs work better by giving them more memory.

QEMM helps you get the most out of the software you own today.

#1

QEMM is not only the best selling memory manager, it's the number one selling PC utility.



Quarterdeck

Quarterdeck International Ltd., B.I.M. House, Crofton Terrace, Dun Laoghaire, Co. Dublin, Ireland
Tel. (353) (1) 284-1444 Fax: (353) (1) 284-4380 Tech Support Tel. (44) (71) 973-0663 Fax: (44) (71) 973-0664

©1992 Quarterdeck Office Systems. PC Week Analyst's Choice Logo ©1991, Ziff Communications Company. PC Week is a registered trademark and the PC Week Analyst's choice logo is a trademark of the Ziff-Davis Publishing Company. Other trademarks are property of their respective owners.

Circle 309 on Inquiry Card.

The 1992 Readers' Choice Awards

The best products picked by the toughest judges—BYTE readers

MICHAEL NADEAU

1992
BYTE
READERS' CHOICE
AWARD

BYTE readers are a special lot. You know and demand more than the average computer user does. The products you use must be on the cutting edge of technology yet practical for your needs. You also have a keen eye for value.

Each year, we ask you to vote for the products that meet with your high standards for use in a business environment. The results—with some surprises—are presented here. (Past BYTE Readers' Choice Award results have gone against prevailing opinion and market-share data. In fact, your views seem to be a leading indicator of brand preference. For instance, in 1991, you chose Borland's Quattro Pro as the top spreadsheet program before Lotus 1-2-3 began losing market share.)

Four items in particular are worth noting. The first is Apple's PowerBook, which took top portable honors as well as Hardware Product of the Year. Clearly, the PowerBook has a strong appeal outside the traditional Mac-installed base—take note, Toshiba, Compaq, et al. Then there's the Zeos Notebook 386, which took second in the rankings for portables. This proves not only that Zeos has a solid offering but that notebook buyers have embraced the mail-order channel.

The third item is Next's Nextstation, which tied for first place in the workstation category with IBM's RISC System/6000. Sales figures do not reflect this result, of course. You don't have

to own a product to vote for it (after all, state of the budget usually takes precedence over state of the art). Perhaps Next's fortunes are about to take a turn for the better.

For Software Product of the Year, we might have guessed that Apple's System 7.0 or Microsoft Word for Windows 2.0 would be your choice—but no. Instead, you chose Microsoft's MS-DOS 5.0 for this honor. MS-DOS 5.0 has arguably improved the lives of more computer users than any other single product over the past year. Good choice.

Other Items of Note

As with Congress, some incumbents seem to have a lock on their BYTE Readers' Choice Award titles. But unlike elected officials, these products retain their places of honor by consistently providing more for their constituents. To indicate return winners, we've placed an asterisk next to their names, even though some versions and model designations may have changed.

This year, we list not just the winners but also the runners-up to provide a wider perspective on each category. Please note, too, that during the time between creating the survey you filled out and printing the results here, some companies may have revised their products; therefore, we provide the most current versions in the Company Information box.

Congratulations to the winners of this year's BYTE Readers' Choice Awards. If you can win in this crowd, you've got it made.

continued

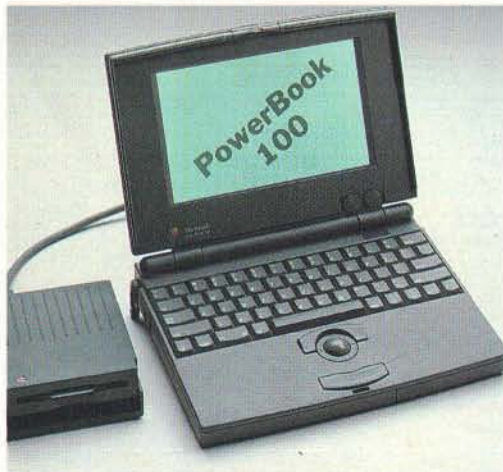

HARDWARE PRODUCT OF THE YEAR

Winner
PowerBook
series, Apple
Computer

Runners-Up
HP LaserJet
IIISi, Hewlett-
Packard
Mac Quadra
series, Apple
Computer

SOFTWARE PRODUCT OF THE YEAR

Winner
MS-DOS 5.0,
Microsoft

Runners-Up
Windows 3.0,
Microsoft
Turbo C++,
Borland
International

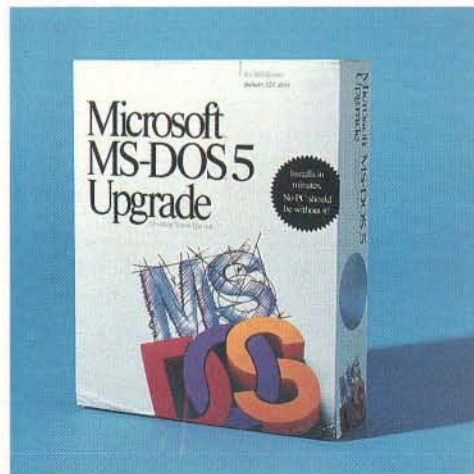

HARDWARE

HARDWARE PRODUCT OF THE YEAR

Winner
PowerBook series,
Apple Computer

Runners-Up
HP LaserJet IIISi,
Hewlett-Packard
Mac Quadra series,
Apple Computer

DESKTOP COMPUTERS—PC

Winner
486DX, Gateway 2000

Runners-Up
386DX, Gateway 2000
Dell 486, Dell Computer

DESKTOP COMPUTERS—MAC

Winner
Mac Quadra series,
Apple Computer

Runners-Up
Mac IIfx and IIsi,
Apple Computer

WORKSTATIONS

Winners (tie)
Nextstation, Next
IBM RISC System/6000, IBM

Runner-Up
Sparcstation IPX,
Sun Microsystems

Gateway 2000 486DX



PORTABLES/ NOTEBOOKS

Winner
PowerBook series,
Apple Computer

Runners-Up
Notebook 386, Zeos
T2200SX, Toshiba

HAND-HELDS/PALMTOPS

Winner
HP 95LX, Hewlett-Packard

Runners-Up
Wizard, Sharp Electronics
Poqet PC, Poqet Computer

MODEMS (9600 bps)

Winner
*Ultra 96, Hayes
Microcomputer Products

Runners-Up
Optima 96, Hayes
Microcomputer Products
9600EX, Intel

Hewlett-Packard HP 95LX

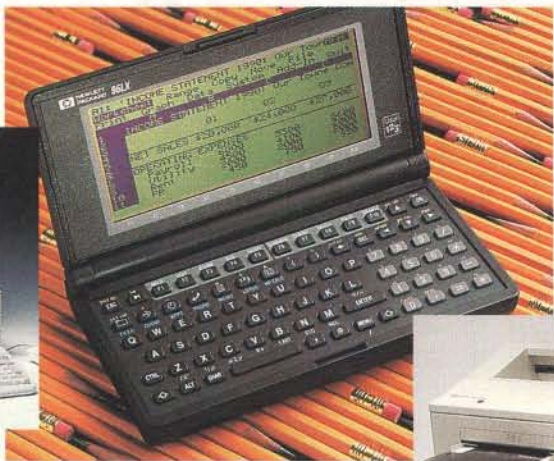

Hewlett-Packard
HP LaserJet
IIISi



MONITORS

Winner
*MultiSync 4FG,
NEC Technologies

Runners-Up
Diamond Scan 16, Mitsubishi
Electronics America
Nanao T560i, Nanao USA

LASER PRINTERS

Winner
*HP LaserJet IIISi, Hewlett-Packard

Runners-Up
HP LaserJet IIIp,
Hewlett-Packard
HP LaserJet IIp Plus, Hewlett-Packard

VIDEO BOARDS— DOS/WINDOWS

Winner
VGAWonder XL,
ATI Technologies

Runners-Up
8514-Ultra, ATI Technologies
ProDesigner IIs,
Orchid Technology

VIDEO BOARDS—MAC

Winner
PrecisionColor 24x, Radius

Runners-Up
Mac Display Card 8•24GC,
Apple Computer
24XLTV, RasterOps

SOFTWARE

SOFTWARE PRODUCT OF THE YEAR

Winner
MS-DOS 5.0, Microsoft

Runners-Up
Windows 3.0, Microsoft
Turbo C++, Borland
International

WORD PROCESSING SOFTWARE—DOS/WINDOWS

Winner
*WordPerfect 5.1, WordPerfect

Runners-Up
Word for Windows 2.0,
Microsoft
Ami Pro 2.0, Lotus Development

WORD PROCESSING SOFTWARE—MAC

Winner
Word for Macintosh 5.0,
Microsoft

Runners-Up
WordPerfect 2.1, WordPerfect
MacWrite II 1.1, Claris

CAD SOFTWARE—DOS/WINDOWS

Winner
*AutoCAD release 11,
Autodesk

Runners-Up
Generic CADD 6.0,
Generic Software
DesignCAD, American Small
Business Computers

CAD SOFTWARE—MAC

Winner
*Claris CAD, Claris

Runners-Up
DesignCAD 2D/3D, American
Small Business Computers
Vellum, Ashlar

CONTACT MANAGERS/ PERSONAL INFORMATION MANAGERS

Winner
*Agenda 2.0, Lotus
Development

Runners-Up
PackRat 4.0, Polaris Software
askSam, askSam Systems

DATABASE MANAGERS, PROGRAMMABLE—DOS/WINDOWS

Winner
*Paradox 3.5, Borland
International

Runners-Up
FoxPro 2.0, Fox Software
dBase IV, Borland International

DATABASE MANAGERS, PROGRAMMABLE—MAC

Winner
*FileMaker Pro, Claris

Runners-Up
4th Dimension, Acius
Omnis 7, Blyth Software

DATABASE CLIENT/SERVER

Winner
*NetWare SQL, *Novell*

Runners-Up
Oracle Server, *Oracle*
SQL Server, *Microsoft*
Sybase

DESKTOP PUBLISHING SOFTWARE—DOS/WINDOWS

Winner
*PageMaker 4.0 for Windows, *Aldus*

Runners-Up
Ventura Publisher 4.0 (Windows), *Ventura Software*
PFS: First Publisher, *Spinnaker Software*

DESKTOP PUBLISHING SOFTWARE—MAC

Winner
*PageMaker 4.2 for Macintosh, *Aldus*

Runners-Up
Ventura Publisher 3.0, *Ventura Software*
QuarkXPress 3.1, *Quark*

DESKTOP PUBLISHING SOFTWARE—UNIX

Winner
*FrameMaker, *Frame Technology*

Runners-Up
Interleaf 5 (formerly TPS/Slim), *Interleaf*
Island Write/Paint/Draw, *Island Graphics*

E-MAIL AND WORKGROUP SOFTWARE—DOS/WINDOWS

Winner
cc:Mail, *Lotus Development*

Runners-Up
Microsoft Mail (Windows), *Microsoft*
WordPerfect Office 3.1, *WordPerfect*

E-MAIL AND WORKGROUP SOFTWARE—MAC

Winner
Microsoft Mail, *Microsoft*

Runner-Up
cc:Mail, *Lotus Development*

GRAPHICS SOFTWARE—DOS/WINDOWS

Winner
*CorelDraw 2.01L for Windows, *Corel Systems*

Runners-Up
Designer 3.1, *Micrografx*
Adobe Illustrator 4.0 for Windows, *Adobe Systems*

GRAPHICS SOFTWARE—MAC

Winner
*Adobe Illustrator 3.0.1, *Adobe Systems*

Runners-Up
MacDraw Pro 1.0, *Claris*
Canvas 3.0, *Deneba Software*

NETWORK OPERATING SYSTEMS—DOS AND OS/2

Winner
*NetWare 3.11, *Novell*

Runners-Up
LANtastic, *Artisoft*
LAN Manager, *Microsoft*

NETWORK OPERATING SYSTEMS—MAC

Winner
*NetWare 3.0, *Novell*

Runners-Up
AppleShare 3.0, *Apple Computer*
TOPS 3.0, *Sitka*

MEMORY MANAGERS

Winner
QEMM 386, *Quarterdeck Office Systems*

Runners-Up
386Max 6.0, *Qualitas*
386VMM, *Phar Lap Software*

OPTICAL CHARACTER RECOGNITION SOFTWARE

Winner
OmniPage Professional 2.0, *Caere*

Runners-Up
ReadRight for Windows 3.11, *OCR Systems*
WordScan+, *Calera Recognition Systems*

OPERATING SYSTEMS/ENVIRONMENTS

Winner
MS-DOS 5.0, *Microsoft*

Runners-Up
Windows 3.0, *Microsoft*
System 7.0, *Apple Computer*

AutoCAD
release 11



PROGRAMMING LANGUAGES—DOS/WINDOWS

Winner
*Turbo C++, *Borland International*

Runners-Up
Visual Basic, *Microsoft*
Turbo Pascal, *Borland International*

PROGRAMMING LANGUAGES—MAC

Winner
Zortech C++ 2.1.3, *Symantec*

Runners-Up
HyperCard 2.1, *Claris*
Think C 5.0, *Symantec*

PROJECT MANAGEMENT SOFTWARE

Winner
*Project for Windows 3.0, *Microsoft*

Runners-Up
Harvard Project Manager, *Software Publishing*
Time Line 5.0, *Symantec*

SPREADSHEETS—DOS/WINDOWS

Winner
*Quattro Pro 3.0, *Borland International*

Runners-Up
Excel for Windows, *Microsoft*
Lotus 1-2-3 2.3, *Lotus Development*
Lotus 1-2-3 3.1+, *Lotus Development*

SPREADSHEETS—MAC

Winner
Excel for Macintosh, *Microsoft*

Runners-Up
Lotus 1-2-3 for Macintosh, *Lotus Development*
Wingz, *Informix Software*

UTILITIES—DOS/WINDOWS

Winner
*Norton Utilities 6.0, *Symantec*

Runners-Up
PC Tools Deluxe 7.1, *Central Point Software*
Norton Desktop for Windows, *Symantec*

UTILITIES—MAC

Winner
Norton Utilities for Macintosh 1.1, *Symantec*

Runners-Up
Mac Tools Deluxe, *Central Point Software*
Symantec Utilities (SUM) II 2.1, *Symantec*

PageMaker 4.2



CorelDraw 2.01L for Windows



COMPANY INFORMATION

Acius, Inc.
4th Dimension
 10351 Bubb Rd.
 Cupertino, CA 95014
 (408) 252-4444
 fax: (408) 252-0831
Circle 984 on Inquiry Card.

Adobe Systems, Inc.
Adobe Illustrator 3.0.1
Adobe Illustrator 4.0
 1625 Charleston Rd.
 P.O. Box 7900
 Mountain View, CA 94039
 (800) 833-6687
 (415) 961-4400
 fax: (415) 961-3769
Circle 985 on Inquiry Card.

Aldus Corp.
PageMaker 4.2 for Macintosh
PageMaker 4.0 for Windows
 411 First Ave. S
 Seattle, WA 98104
 (206) 622-5500
 fax: (206) 622-4240
Circle 986 on Inquiry Card.

American Small Business Computers, Inc.
DesignCAD 3D
DesignCAD 2D/3D
 1 American Way
 Pryor, OK 74361
 (918) 825-4844
 fax: (918) 825-6359
Circle 987 on Inquiry Card.

Apple Computer, Inc.
*Macintosh Display Card 8*24GC*
AppleShare 3.0
Mac IICI
Mac IISI
Mac Quadra series
PowerBook series
System 7.0
 20525 Mariani Ave.
 Cupertino, CA 95014
 (408) 996-1010
Circle 988 on Inquiry Card.

Artisoft, Inc.
LANTastic
 691 East River Rd.
 Tucson, AZ 85704
 (800) 846-9726
 (602) 293-4000
 fax: (602) 293-8065
Circle 989 on Inquiry Card.

Ashlar, Inc.
Vellum
 1290 Oakmead Pkwy.,
 Suite 218
 Sunnyvale, CA 94086
 (408) 746-1800
 fax: (408) 746-0749
Circle 990 on Inquiry Card.

askSam Systems
askSam
 P.O. Box 1428
 Perry, FL 32347
 (904) 584-6590
 fax: (904) 584-7481
Circle 991 on Inquiry Card.

ATI Technologies, Inc.
8514-Ultra
VGA Wonder XL
 3761 Victoria Park Ave.
 Scarborough, Ontario,
 Canada M1W 3S2
 (416) 756-0718
 fax: (416) 756-0720
Circle 992 on Inquiry Card.

Autodesk, Inc.
AutoCAD release 11
 2320 Marinship Way
 Sausalito, CA 94965
 (415) 332-2344
 fax: (415) 331-8093
Circle 993 on Inquiry Card.

Blyth Software
Omnis 7
 1065 East Hillside Blvd., Suite 300
 Foster City, CA 94404
 (800) 346-6647
 (415) 312-7100
 fax: (415) 571-1132
Circle 994 on Inquiry Card.

Borland International
dBase IV
Paradox 3.5
Quattro Pro 3.0
Turbo C++
Turbo Pascal
 1800 Green Hills Rd.
 P.O. Box 660001
 Scotts Valley, CA 95066
 (408) 438-8400
 fax: (408) 439-9344
Circle 995 on Inquiry Card.

Caere Corp.
OmniPage Professional 2.0
 100 Cooper Court
 Los Gatos, CA 95030
 (800) 535-7226
 (408) 395-7000
Circle 996 on Inquiry Card.

Calera Recognition Systems, Inc.
WordScan+
 475 Potrero Ave.
 Sunnyvale, CA 94086
 (408) 720-8300
 fax: (408) 720-1330
Circle 997 on Inquiry Card.

Central Point Software, Inc.
Mac Tools Deluxe
PC Tools Deluxe 7.1
 15220 Northwest Greenbrier
 Pkwy., Suite 200
 Beaverton, OR 97006
 (503) 690-8090
 fax: (503) 690-8083
Circle 998 on Inquiry Card.

Claris Corp.
Claris CAD
FileMaker Pro
HyperCard 2.1
MacDraw Pro 1.0
MacWrite II 1.1
 5201 Patrick Henry Dr.
 Santa Clara, CA 95052
 (408) 987-7000
 fax: (408) 987-4400
Circle 999 on Inquiry Card.

Corel Systems Corp.
CorelDraw 2.01L
 1600 Carling Ave.
 Ottawa, Ontario,
 Canada K1Z 8R7
 (613) 728-8200
 fax: (613) 728-9790
Circle 1060 on Inquiry Card.

Dell Computer Corp.
486P/33
 9505 Arboretum Blvd.
 Austin, TX 78759
 (800) 232-5620
 (512) 338-4400
 fax: (512) 343-3312
Circle 1062 on Inquiry Card.

Deneba Software
Canvas 3.0
 3305 Northwest 74th Ave.
 Miami, FL 33122
 (305) 594-6965
 fax: (305) 477-5794
Circle 1063 on Inquiry Card.

Fox Software
FoxPro 2.0
 134 West South Boundary
 Perrysburg, OH 43551
 (419) 874-0162
 fax: (419) 874-8678
Circle 1064 on Inquiry Card.

Frame Technology Corp.
FrameMaker
 1010 Rincon Cir.
 San Jose, CA 95131
 (408) 433-3311
Circle 1065 on Inquiry Card.

Gateway 2000
486DX
386DX
 610 Gateway Dr.
 P.O. Box 2000
 North Sioux City, SD 57049
 (800) 523-2000
 (605) 232-2000
 fax: (605) 232-2023
Circle 1066 on Inquiry Card.

Generic Software, Inc.
Generic CADD 6.0
 11911 North Creek Pkwy.
 South Bothell, WA 98011
 (206) 487-2233
 (800) 228-3601
 fax: (206) 483-6964
Circle 1067 on Inquiry Card.

Hayes Microcomputer Products, Inc.
Ultra 96
Optima 96
 P.O. Box 105203
 Atlanta, GA 30348
 (404) 840-9200
 fax: (404) 441-1238
Circle 1068 on Inquiry Card.

Hewlett-Packard Co.
HP 95LX
 1000 Northeast Circle Blvd.
 Corvallis, OR 97330
 (503) 757-2000
 fax: (503) 750-3399
Circle 1235 on Inquiry Card.

Hewlett-Packard Co.
HP LaserJet IIp
HP LaserJet IIIp
HP LaserJet IIISi
 Direct Marketing Organization
 P.O. Box 58059
 Santa Clara, CA 95051
 (800) 752-0900
Circle 1236 on Inquiry Card.

IBM Corp.
IBM RISC System/6000
 U.S. Marketing and Services
 1133 Westchester Ave.
 White Plains, NY 10604
 (800) 365-4426
Circle 1237 on Inquiry Card.

Informix Software, Inc.
Wingz
 4100 Bohannon Dr.
 Menlo Park, CA 94025
 (415) 926-6300
Circle 1238 on Inquiry Card.

Intel Corp.
9600EX
 PC Enhancement Division
 5200 Northeast Elam Young Pkwy.
 Hillsboro, OR 97124
 (503) 696-7086
Circle 1239 on Inquiry Card.

Interleaf, Inc.
Interleaf 5
 Prospect Place
 9 Hillside Ave.
 Waltham, MA 02154
 (617) 290-0710
 fax: (617) 290-4943
Circle 1240 on Inquiry Card.

Island Graphics Corp.
Island Write/Print/Draw
 4000 Civic Center Dr.
 San Rafael, CA 94903
 (415) 491-1000
 fax: (415) 491-0402
Circle 1241 on Inquiry Card.

continued

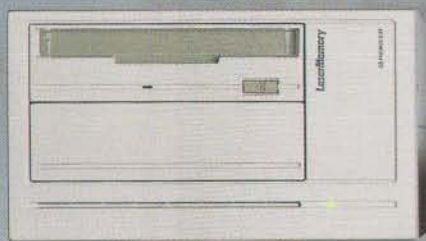

WORM
(DD-S5101)

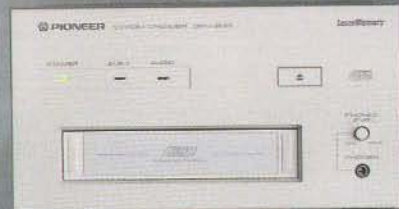

CD-ROM Minichanger
(DRM-600)

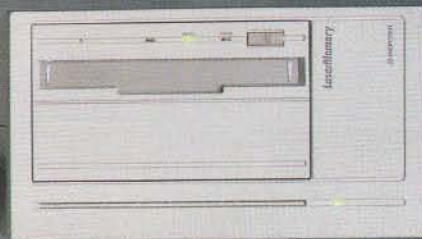

Multifunction
(DE-S7001)

WE DIDN'T HAVE TO PUT OUR OPTICAL PRODUCTS ON PEDESTALS. JERRY POURNELLE DID.

“ I am pleased to report that I'm sold. The Pioneer optical drive... is as solid as a rock.... Thus, I'm discontinuing testing. Now I'll just use the drive. ... I now rely on the Pioneer erasable optical disks for backup, for primary storage of really big files, and for archive copies of software... you really need something so easy to use that you'll routinely use it for backup... the Pioneer DE-S7001 will do the job very well indeed. Recommended. *Byte* (9/91)

The Pioneer six-pack CD-ROM Minichanger is great. We've had it in operation for the best part of the year now, on a number of different systems.... It has always performed flawlessly... it changes drives a lot faster than you'd expect it to.... It's really fast.... Accesses that used to take many seconds are now nearly instantaneous. Accesses that took over a minute now take a few seconds. I always did like the Minichanger.... Now it's even better.... Incidentally, the Pioneer Minichanger will work just fine with a Mac. *Byte* (10/91)

The Pioneer DE-S7001 dual-purpose external optical disk drive I've written about before. Log your wordprocessor to that, save early and often, and you'll have it all.... In a word, WORM drives look like

the ultimate in backup storage. *Byte* (12/91)

Suppose you erase a file? Overwrite one you wanted to keep? And suppose your house burned down? You don't have any off-site backup at all.... I could remedy that by installing the DE-S7001 on the network server and archiving on that.... *Byte* (11/91)

I have the DRM-600 running not only with QEMM386.SYS, but inside DESQview windows, which has the amusing result that I can actually have several CD-ROM windows open at once.... It's surprising how fast you can switch back and forth among them.... The Pioneer DRM-600... it's very convenient to have a bunch of CD-ROMs available without swapping. *Byte* (1/91)

It's quite intuitive [the Pioneer CD-ROM Minichanger]: no instructions are required.... Recommended. *Byte* (1/91)

This technology is coming of age. *Byte* (1/91)

For more information or for a free VHS videotape "Pioneering The Future," about Pioneer optical disk products, call 1-800-LASER-ON, and find out why Pioneer is the leader in optical disk technology.



JERRY POURNELLE
RENOWNED COMPUTER COLUMNIST

Pioneer DE-S7001, Pioneer DRM-600, and Pioneer DD-S5101 are trademarks of Pioneer Communications of America, Inc. QEMM386.SYS and DESQview are trademarks of Quarterdeck Office Systems.

COMPANY INFORMATION

Lotus Development Corp.

Agenda 2.0
cc:Mail (MS-DOS and Mac)
Lotus 1-2-3 2.3
Lotus 1-2-3 3.1+
Lotus 1-2-3 for Macintosh
 161 First St.
 Cambridge, MA 02142
 (617) 577-8500
Circle 1242 on Inquiry Card.

Lotus Development Corp.

Ami Pro 2.0
 Word Processing Division
 1000 Abernathy Rd., Suite 1700
 Building 400
 Atlanta, GA 30342
 (404) 851-0007
Circle 1243 on Inquiry Card.

Micrografx, Inc.

Designer 3.1
 1303 Arapaho
 Richardson, TX 75081
 (800) 733-3729
 (214) 234-1769
 fax: (214) 234-2410
Circle 1244 on Inquiry Card.

Microsoft Corp.

Excel for Macintosh
Excel for Windows
LAN Manager 2.0
Microsoft Mail
MS-DOS 5.0
Project for Windows 3.0
SQL Server
Visual Basic
Windows 3.0
Word for Windows 2.0
Word for Macintosh 5.0
 1 Microsoft Way
 Redmond, WA 98052
 (206) 882-8080
 fax: (206) 883-8101
Circle 1402 on Inquiry Card.

Mitsubishi Electronics America, Inc.

Diamond Scan 16
 5665 Plaza Dr.
 Cypress, CA 90630
 (800) 843-2515
 (714) 220-2500
 fax: (714) 236-6172
Circle 1245 on Inquiry Card.

Nanao USA Corp.

Nanao T560i
 23535 Telo Ave.
 Torrance, CA 90505
 (800) 800-5202
 (213) 325-5202
 fax: (213) 530-1679
Circle 1246 on Inquiry Card.

NEC Technologies, Inc.

MultiSync 4FG
 1255 Michael Dr.
 Wood Dale, IL 60191
 (708) 860-7600
Circle 1247 on Inquiry Card.

Next Computer, Inc.

Nextstation
 900 Chesapeake Dr.
 Redwood City, CA 94063
 (415) 366-0900
 fax: (415) 780-3714
Circle 1248 on Inquiry Card.

Novell, Inc.

NetWare 3.0
NetWare 3.11
NetWare SQL
 122 East 1700 South
 Provo, UT 84606
 (800) 346-7177
 (801) 429-5900
 fax: (801) 429-5155
Circle 1249 on Inquiry Card.

OCR Systems, Inc.

ReadRight for Windows 3.11
 1800 Byberry Rd., Suite 1405
 Huntingdon Valley, PA 19006
 (215) 938-7460
 fax: (215) 938-7465
Circle 1250 on Inquiry Card.

Oracle Corp.

Oracle Server
 500 Oracle Pkwy.
 Redwood Shores, CA 94065
 (800) 392-2999
 (415) 506-7000
Circle 1251 on Inquiry Card.

Orchid Technology

ProDesigner II
 45365 Northport Loop W
 Fremont, CA 94538
 (510) 683-0300
 fax: (510) 490-9312
Circle 1252 on Inquiry Card.

Phar Lap Software, Inc.

386VMM
 60 Aberdeen Ave.
 Cambridge, MA 02138
 (617) 661-1510
 fax: (617) 876-2972
Circle 1253 on Inquiry Card.

Polaris Software

PackRat 4.0
 17150 Via Del Campo, Suite 307
 San Diego, CA 92127
 (800) 722-5728
 (619) 674-6500
Circle 1254 on Inquiry Card.

Poquet Computer Corp.

Poquet PC
 5200 Patrick Henry Dr.
 Santa Clara, CA 95054
 (408) 982-9500
 fax: (408) 496-0575
Circle 1255 on Inquiry Card.

Qualitas, Inc.

386Max 6.0
 7101 Wisconsin Ave., Suite 1386
 Bethesda, MD 20814
 (301) 907-7400
 fax: (301) 718-6060
Circle 1256 on Inquiry Card.

Quark, Inc.

QuarkXPress 3.1
 300 South Jackson, Suite 100
 Denver, CO 80209
 (303) 934-2211
 fax: (303) 377-6327
Circle 1257 on Inquiry Card.

Quarterdeck Office Systems

QEMM 386
 150 Pico Blvd.
 Santa Monica, CA 90405
 (213) 392-9851
 fax: (213) 399-3802
Circle 1258 on Inquiry Card.

Radius, Inc.

Precision Color 24x
 1710 Fortune Dr.
 San Jose, CA 95131
 (408) 434-1010
 fax: (408) 434-0770
Circle 1259 on Inquiry Card.

RasterOps

24XLTV
 2500 Walsh Ave.
 Santa Clara, CA 95051
 (408) 562-4200
 fax: (408) 562-4066
Circle 1260 on Inquiry Card.

Sharp Electronics Corp.

Wizard
 P.O. Box 650
 Sharp Plaza
 Mahwah, NJ 07430
 (800) 237-4277
 (201) 529-8731
 fax: (800) 321-8877
Circle 1261 on Inquiry Card.

Sitka Corp.

TOPS 3.0
 950 Marina Village Pkwy.
 Alameda, CA 94501
 (800) 445-8677
 (510) 769-9669
 fax: (510) 769-8772
Circle 1262 on Inquiry Card.

Software Publishing Corp.

Harvard Project Manager
 3165 Kifer Rd.
 P.O. Box 54983
 Santa Clara, CA 95056
 (408) 986-8000
 fax: (408) 980-0729
Circle 1263 on Inquiry Card.

Spinnaker Software Corp.

PFS: First Publisher
 201 Broadway
 Cambridge, MA 02139
 (617) 494-1200
Circle 1264 on Inquiry Card.

Sun Microsystems, Inc.

Sparcstation IPX
 2550 Garcia Ave.
 Mountain View, CA 94043
 (415) 960-1300
 fax: (415) 969-9131
Circle 1265 on Inquiry Card.

Symantec Corp.

Norton Desktop for Windows
Norton Utilities 6.0
Norton Utilities for Macintosh 1.1
Symantec Utilities (SUM) II 2.1
Think C 5.0
Time Line 5.0
 10201 Torre Ave.
 Cupertino, CA 95014
 (800) 441-7234
 (408) 253-9600
 fax: (408) 253-4092
Circle 1266 on Inquiry Card.

Symantec Corp.

Zortech C++ 2.1.3
 135 South Rd.
 Bedford, MA 01730
 (617) 275-4800
Circle 1401 on Inquiry Card.

Toshiba America Information Systems, Inc.

T2200SX
 9740 Irvine Blvd.
 Irvine, CA 92713
 (800) 334-3445
 (714) 583-3000
 fax: (714) 587-6034
Circle 1267 on Inquiry Card.

Ventura Software, Inc.

Ventura Publisher 3.0
Ventura Publisher 4.0
 15175 Innovation Dr.
 San Diego, CA 92128
 (619) 673-0172
 fax: (619) 673-7672
Circle 1268 on Inquiry Card.

WordPerfect Corp.

WordPerfect 2.1
WordPerfect 5.1
WordPerfect Office 3.1
 1555 North Technology Way
 Orem, UT 84057
 (801) 225-5000
 fax: (801) 222-4477
Circle 1269 on Inquiry Card.

Zeos International, Ltd.

Notebook 386
 530 Fifth Ave. NW
 St. Paul, MN 55112
 (612) 633-5877
 fax: (612) 633-1325
Circle 1400 on Inquiry Card.

MINUTEMAN PLUGS IN WORLDWIDE.

Now get total power protection from MINUTEMAN anywhere in the world. MINUTEMAN takes charge worldwide with instant protection when you need it most.

Every day your company relies on its voice and data communications equipment to stay productive. Unfortunately, the electricity that powers these vital systems is not reliable.

Blackouts, brownouts, spikes, surges and even lightning strikes are common. And the high cost of losing vital information and productivity due to power outages and



surges calls for preventive measures.

But power requirements can be confusing. And your company has unique needs that often require custom solutions.

MINUTEMAN offers the most comprehensive line

of UPS systems available, protecting all your business equipment from stand-alone workstations to the largest of the IBM AS/400s.

MINUTEMAN products are sold and serviced worldwide. Call on our skilled professionals to help you determine your exact power protection needs.

MINUTEMAN PRODUCTS

- On-line and standby UPS
- Shutdown software for every available operating system
- 300VA to 10KVA
- TUV approval
- Now in over 100 countries
- Regional service centers
- Automatic voltage regulators
- All international voltages

Contact our Power Professionals on the **POWER FAXLINE** below, or call **(214) 446-7363** for your free Power Protection Guide.

(214) 446-9011 Fax

MINUTEMAN[®]
UNINTERRUPTIBLE POWER SUPPLIES



Our MINUTEMAN Global Socket (GS) Series un-interruptible power supplies accommodate the unique needs of our international

customers. You no longer need to use adaptors or cut and splice on a new plug. Our GS UPS systems are universal and compatible with all major

plug patterns.

Our UPS systems are ready for both the individual computer and for your network. These popular MINUTEMAN UPS systems employ our advanced technology to create the most dependable UPS available.

By integrating the latest MOSFET technology requiring fewer components, each GS Series

model is more compact. The result is a truly advanced and economical UPS for all your business needs, worldwide.

Global Socket UPS systems are universal and compatible with these plug patterns.

- British (standard)
- European (Europlug)
- Australian
- Italian
- French

FOR I.A.N. **NOVELL TESTED**



Circle 136 on Inquiry Card.



I wanted to be a rock & roll star.

(I became an engineer.)

I wanted to live in a house by a beach.

(I live at the office.)

I wanted to have a powerful workstation.

(I thought I could only afford a PC.)

Life does have its compensations.

Sun SPARCstation IPC. \$5995.



The exhilaration of using a Sun™ SPARCstation™ has always been one of life's seductive pleasures. But at \$5995, it is also one of life's obtainable pleasures, too.

Indeed, a SPARCstation system not only runs your CAD software better and faster, it can run every application you use all at the same time.

And with 4,087 applications to choose from, including favorites like AutoCAD,™ CADKEY,™ Personal Designer,™ MicroStation SPARC,™ Lotus 1-2-3® and dBASE® IV, SPARCstation performance never slows your choices.

In fact, the only compromise you may have to make is which of the two most popular fully-configured* Sun models to choose: The Sun SPARCstation IPC™ at \$5995, or the SPARCstation IPX™ at \$9995.

But then, life has always been a bit unfair.

1-800-426-5321, ext. 475. For more information and your nearest authorized Sun reseller.

 *Sun Microsystems*
Computer Corporation

486-B²T

486/860 Speed... Microway Quality.

Microway has engineered four distinctive black tower systems. The **486-B²T** is designed for high-end users. It comes standard with American 486 motherboards and power supplies, yet has a reasonable starting price of \$2,195. A broad range of options can be installed including high speed and capacity hard disks, intelligent serial controllers, tape back-up units, high end graphics adapters and our *Number Smasher-860*. These systems are ideal for configuring Novell or UNIX file servers, multiuser systems, and workstations for graphics, CAD and scientific uses. The **486-B²T** comes with dual fans, *Across the Board™* Cooling and American industrial grade power supplies. All systems are thoroughly tested, burned in and include the best technical support in the industry, which we've provided since 1982.



Number Smasher-860

The key to attaining workstation performance is Microway's 40MHz *Number Smasher-860*. It features a four-way interleaved 64-bit memory system that runs at 160 megabytes/sec. The *Number Smasher's* i860 has been clocked at 80 megaflops doing matrix multiplies, 67 megaflops doing FFTs and 11.8 Double Precision Linpack Megaflops on large arrays—ten times the speed of a 486 and twice the speed of a Cray 1F! One happy user recently reported that his "Baby Cray" was happily humming away saving him thousands of dollars per month in 3090 rentals. The *Number Smasher* comes with the finest i860 compilers on the market, your choice of Microway's NDP™ FORTRAN, C|C++ or Pascal.

Call or write today for more information on Microway's new black tower systems.



Microway®

Technology You Can Count On

Corporate Headquarters, Box 79, Kingston, MA 02364 USA • TEL 508-746-7341 • FAX 508-746-4678 • U.K./Europe 081-541-5466
France 01 43 2 69593 • Germany 069-75-2023 • Holland 40 836455 • Italy 02-74.90.749 • Japan 0474 23 1322 • Norway 6-892020

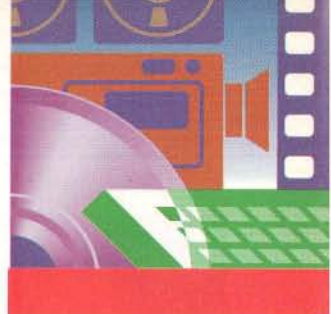

Winning Graphics

With the right software, you can easily add text, pictures,
and animation to your video presentation

TOM YAGER

Today's desktop computers are graphics powerhouses. Capable of creating and manipulating high-resolution images of 16 million colors, their potential is wasted if you use them in desktop video only to control your peripherals. Computer-generated graphics are a pivotal element of most desktop-produced videos. In fact, they're so important that I'll devote this entire article to the creation of graphics for video.

You don't need to be an artist to create impressive graphics for your desktop videos. You simply need to start with the right graphics hardware and software and then learn to compose graphics that capture the audience's attention but don't distract them from your message. Once you read this article, you should have no problems getting started—then the rest is up to you.

Getting What You Want

In a perfect world, a computer would do everything you wanted it to. With desktop video, as with other applications, different systems have various strengths and weaknesses, thanks to the selection of software that exists for each platform. My work is undoubtedly different than yours, so I can't advise you what to buy. I'm hoping, however, that by detailing some of the choices I made, you can gain some helpful insights. Thus, this article is by no means a complete roundup of graphics products and techniques; rather, it is one traveler's tale, detailing a few of the many possible approaches to desktop video graphics.

I set out to endow each of the BYTE Multimedia Lab's three systems with as much self-sufficiency as possible. Where graphics are concerned, I largely succeeded: All three machines are capable of generating their own two-dimensional and 3-D graphics, suitable for inclusion in a video production. I have the freedom to cheat, of course, since I have three fairly powerful machines within a rolling chair's distance of one another. So yes, I do tend to mix and match a bit, and I use the Lab's machines a lot simply because they're there. A multiplatform setup has a lot to recommend it. If you have the

means, you should consider broadening your options by constructing a multiplatform facility.

Living in Flatland

The majority of graphics work for video gets done in 2-D. But these days, most 2-D graphics software is graced with the ability to make its graphics look 3-D, without the processing overhead of real 3-D.

When people think of producing computer graphics, they generally think of paint programs. While these do the job, they make life more difficult for those of us who couldn't create real art to save our lives. I prefer to work at a higher level, leaning toward tools that permit me to do artistic things. That's not to say I don't apply creativity; I just apply it at a different level.

For example, I have two ways to create a rectangle on the screen and make it appear to be floating above the background. Using a paint package, I can draw an underlying rectangle whose color is slightly darker than that of the background and place it to look like a shadow. Then I can draw a rectangle on top to achieve the simulated depth. I prefer, however, to use a drawing package so that I simply draw a rectangle and then tell the program to put a shadow under it. That way, when I move the rectangle, the shadow moves with it, and I do not have to worry about precise positioning of my graphics. That's a fair example, but there are a number of more complex

BYTE ACTION SUMMARY

Graphics for desktop video comes in three basic styles: text, 2-D images, and 3-D images and animations. Text and 2-D images are easy to manipulate; 3-D is more difficult, but it can add a professional touch to your desktop video presentations.

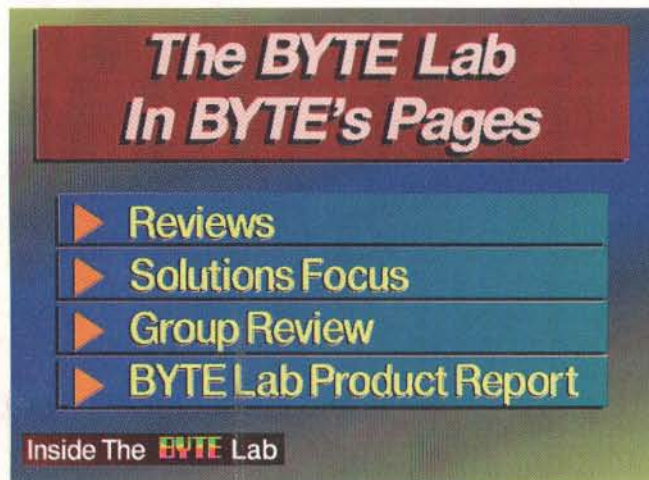

Photo 1: A sample video screen incorporating text with shaded backgrounds, produced with RIO from AT&T Graphics Software Labs.

operations that are much harder to do with paint programs than with the class of products that I'll call "presentation graphics software," for lack of a better moniker.

Producing good-looking graphics is like anything else in video work: You should recognize your limitations and stay within them. For me, accepting that I'm no artist means that I avoid getting too ambitious with my graphical creations. With music, it's amazing what you can create with just 12 notes. With graphics, you can go a long way combining simple shapes and text.

They're Only Words

Almost all graphics created for video include some kind of text, and the most common graphics pages are mostly text. So it pays to keep a few commandments in mind when placing text in videos. The first rule is one you're probably familiar with from desktop publishing: The fewer typefaces on a page, the better. In fact, people will admire your self-restraint if you limit yourself to one or two throughout a video. Typeface changes confuse the eye, and that confusion might cause your audience to tune out your message. One typeface, in multiple sizes and in bold and italic variations, is often all you need, even if it doesn't seem like much fun.

When selecting a font, remember that once it hits your videotape, some unpleasant things are going to happen to it. NTSC video is interlaced—the display first paints the odd-numbered scan lines and then the even-numbered ones. Thus, by design, NTSC video is doing a constant vertical jitterbug. Thin lines jitter more than fat ones, so you need to keep your type sizes big enough to avoid thin lines. Most of the time, I use boldface text. Jittering also affects serif fonts, such as the one used on this page, more than sans serif fonts such as this. Sans serif fonts are more readable in smaller sizes, although serif fonts look just dandy in headlines and other large text.

You also need to remember that a videotape doesn't have the resolution and clarity of your computer's monitor. The smaller your text, the more interlacing and reduced resolution will affect it. Remember, too, that your audience probably won't be sitting as close to the screen as you will when you make your video. If you can easily read your text from a good distance, then you sized it properly. The best solution is to make your text as large as you can without making it appear to scream at the viewer—unless you're doing a video for a tractor pull. If you have a lot of text

to present, don't be bashful about splitting it up into as many screens as needed to maintain a clear viewing size. Also, you should leave plenty of space between rows of text.

Setting the Table

If you're the impatient sort, you might be moved to throw a lot of black letters on a white background and be done with it. That won't impress anyone, however, and it negates a large part of the impetus for doing a video in the first place: to boost your image or your company's. Text works better when placed over an appealing background, and it doesn't take much more work to turn a screen of plain text into something that people notice.

So, what makes an appealing background? First, it can't be too busy. When you shoot a photograph, you're advised to keep the background uncluttered; the same is true for graphical backgrounds. A good background contrasts enough with the text so that the text stands out. Setting up contrast involves choosing colors, which opens a new can of worms.

You can't take color for granted in a video. Obviously, some colors don't go together—where are Garanimals when you need them? However, you should keep in mind that brighter shades tend to bleed when you record them, and too many bright colors in a scene can distort the recorded signal. For that reason, you should remain within a safe range of legal colors, which means avoiding the top and bottom of color intensities. If your graphics package expresses colors numerically as a mixture of RGB values between 0 and 255, you should probably stay between 20 and 240 for each of the three values. Staying in the legal color range also keeps contrasts under control, further reducing the impact interlace has on your graphics.

But legal doesn't have to be boring. A much-used, but effective, way to spice up graphics backgrounds is with gradation. Most graphics packages let you paint your background and the objects you create with smoothly changing patterns of color. A two-color gradation frequently goes from one shade to a lighter or darker shade of the same color, but you can be more creative. A gradation from blue to earthy brown suggests a horizon; from deep orange to deep brown, a sunset. Some packages let you set several gradation points: You can start with dark blue, move to a lighter blue in the middle, and then to dark brown. A conservatively gradated background is probably the most effective way to improve your text screens, and it's so simple to do.

When you place your gradation points, keep in mind the text or other graphical elements that you will place over the background. For example, you might go from a light shade at the top to a darker shade at the bottom and then place a dark-colored (or shadowed) text headline at the top and a lighter-colored body text below. The shading of the background will call attention to your headline, and then it gets out of the way, so the viewer can read the rest of the text.

If you still want to spice up your background, you can use shaded shapes to separate your text (see photo 1). Done right, this helps guide the viewer's eye, making sure he or she doesn't miss any of the most important points. For me, this combination of a main background and subbackgrounds makes the most attractive backdrop.

Once you've got a background that works, save the graphics without the text. This then becomes a template, and you should use only a few templates in your video. That kind of predictability may seem banal, but it works to your advantage. After a viewer sees your template once, his or her trained eyes will quickly jump to emphasized areas when the template appears again.

Of course, there's more to graphics than text and backgrounds. How much more you can do is a function of your graphics software, so I'll move on and discuss some specific tools.

continued



You can get your feet wet, or plumb unimaginable depths.

In a way, it's a lot like CompuServe.

CompuServe members who join for the basics quickly discover an ocean of opportunity. Like at-home shopping, financial data, travel information and reservations, entertainment, and free time to sharpen their online skills.

Computer professionals who join to access a wealth of high-tech expertise find much more. Like sophisticated research tools, hardware and software support forums, and lots of free software and shareware. In fact, no other information service offers the number and quality of choices that CompuServe does.

Now, for just \$7.95 a month, and a one-time membership fee, you get all the basics as often as you like: news, sports, weather, shopping, a complete encyclopedia, and much more, plus up to 60 E-mail messages a month. And, there are lots of other valuable services available on a nominal pay-as-you-use basis.

To make the right choice in selecting an interactive service, pick the one that will always help you get the most out of your computer. For more information or to order CompuServe, see your computer dealer or call 1 800 848-8199. Outside the United States, call 614 457-0802.

CompuServe®

The information service you won't outgrow.

Circle 90 on Inquiry Card.

Doing It

Creating the kind of text-over-graphics screens I've just described is no great exercise on the PC and the Mac. It is, however, a little tougher on an Amiga equipped with Newtek's Video Toaster, because it uses a paint package. But fret not—you can still do it.

It's impossible not to have favorites, and of the 2-D presentation graphics programs I've used, I have yet to find the equivalent to AT&T Graphics Software Labs' (GSL) RIO for the PC. RIO is powerful yet extraordinarily easy to use, and there's no quibbling with the gorgeous results (see photo 1, which was created using RIO). A high-end professional graphics package, RIO renders the scenes you draw using antialiasing, which reduces jagged edges and increases the apparent resolution. It also adjusts your colors to legal NTSC values. RIO uses its own scalable font system, so you can draw, stretch, rotate, and manipulate text any way you like. It also incorporates image mapping, so you can paint scanned images, video captures, and other graphics files onto drawn shapes (including text). In fact, RIO includes built-in support for scanners, printers, and video capture, eliminating the need to purchase additional tools.

RIO, like most 2-D graphics packages, uses polygons and ellipses for creating drawings. Each shape that you draw is a distinct object with associated attributes. With a couple of mouse-clicks on an object, you can add shadows, change a solid color to a multipoint gradation, make it partially transparent, or map an image to the shape. Everything can be moved, resized, and rotated freely. Scenes come together quickly in RIO, thanks partly to the speed of Truevision's ATVista board and partly because RIO drives the board so well. RIO even gives you complete control over the board's settings from within the program. RIO also includes a charting module for business graphics and the option of animating your 2-D scenes, making it even more unnecessary to rely on other graphics packages. RIO's output is breathtaking; I highly recommend it for professional 2-D graphics work.

On the Mac, people tend to use a combination of disjoint tools because Mac tools generally integrate better. My 2-D videographics work is no exception. I do the bulk of my drawing in what you might consider an odd choice: Symantec's More. While it's primarily targeted at creating slides and Mac-based presentations, More has several features that make it a good match for video graphics. Like RIO, it maintains object distinctions and attributes and can apply gradations and shadows. But while it lacks RIO's "do-everything" acumen, More has a couple of tricks that even RIO doesn't include. It has a wide selection of default gradation patterns, and it can create a simulated 3-D look by adding beveled shading to objects (which makes a rectangle look like a plaque). On a Mac running Adobe Type Manager or TrueType, More draws text in scalable fonts, although it can't stretch

and alter them the way RIO can. More serves double duty in the Multimedia Lab, since it includes a powerful outlining tool that I use for planning videos. Finally, while More can't map images to shapes, it can scale and place imported graphics files.

What More can't do, other Mac graphics packages (e.g., Adobe Photoshop and Illustrator) pick up. Most often, however, I simply run what I've built in More through Ray Dream's JAG (jaggies are gone). JAG antialiases the drawing and applies NTSC legalization—steps RIO led me to appreciate.

The Toaster's 2-D graphics module pales next to RIO, but RIO alone costs more than the combined Toaster hardware and software bundle. The module, called ToasterPaint, is powerful, although a bit quirky. The problem is that, like most paint systems, objects lose their identity once they're "tacked down" on the background. That means you must carefully build your graphics from the bottom up. Once you place a graphic, it's an indelible part of the drawings. ToasterPaint handles image mapping and transparency, and because it runs on the Toaster, you can grab frames of video and save them as still images that can be loaded from the Toaster's switcher module.

To simplify things, the Toaster also includes a CG (character generator). This mock-up of an expensive broadcast TV CG is quite capable, and it can create its own smoothly gradated backgrounds. It can also import backgrounds from ToasterPaint, so while you don't have the freedom to easily modify elements of your graphical backgrounds, at least you can work with your text independently. The Toaster's CG includes a huge library of bit-mapped fonts, so you can use only the sizes Newtek supplies you with. However, the fonts include special color ones (e.g., metallic) that offer you a variety of impressive and playful text effects (e.g., crayons bent into letters) you can't get in RIO or More. Like RIO, the Toaster's CG renders text in a separate step but without antialiasing. It handles shadows, however, and it can import text files from other sources.

Photo 2 shows three variations of a scene that includes a layered background, some text, and a captured video image that was created with RIO, More/JAG, and the Toaster, respectively. Don't dig out a magnifying glass and look for differences; the point is to show that each combination of platform and software is capable of generating fine-looking results.

One final note on 2-D graphics: The creation of graphics for video overlay (titling) is usually done at editing time so that the titles don't obscure the video they overlay. Editing is the subject of next month's installment in the series.

A New Dimension

When even simple 3-D scenes take considerably more work than 2-D graphics, you may wonder why you should bother. The

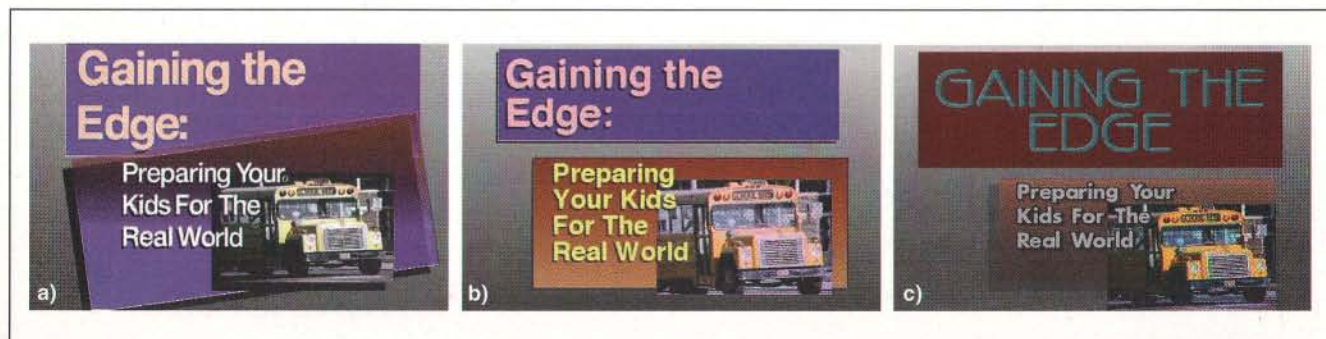

Photo 2: A more complex 2-D scene, created with (a) RIO on the PC, (b) More and JAG on the Mac, and (c) Video Toaster on the Amiga.



AS SEEN IN LAN COMPUTING

Put more power in your PC

Plug MKS Toolkit into any DOS or OS/2 PC and you'll unleash more power and flexibility than you ever believed your hardware could handle. You'll find that MKS Toolkit is the essential piece of DOS or OS/2 software after the operating system itself.

Advanced programming tools once available only on UNIX™ systems are packed into MKS Toolkit for DOS or OS/2 – more than 150 of them, including utilities for:

- prototyping
- advanced command language
- command editing and history

- file processing • text manipulation
- compression • archiving • editing.

And MKS Toolkit is **easy to use**, with on-line manual pages, lots of examples and quality documentation for both novices and experienced users.

You'll be able to get the job done effortlessly too, wherever you're working. For laptop owners, our installation procedure lets you **load only the utilities you want**. For developers working on a UNIX system and a PC, we've made it **easy to copy files across systems**. And MKS Toolkit **tracks the POSIX.2 standard**, a plus for developers in open systems environments. **Networks** are perfect for MKS Toolkit too.

Plug in MKS Toolkit and soar beyond your hardware.

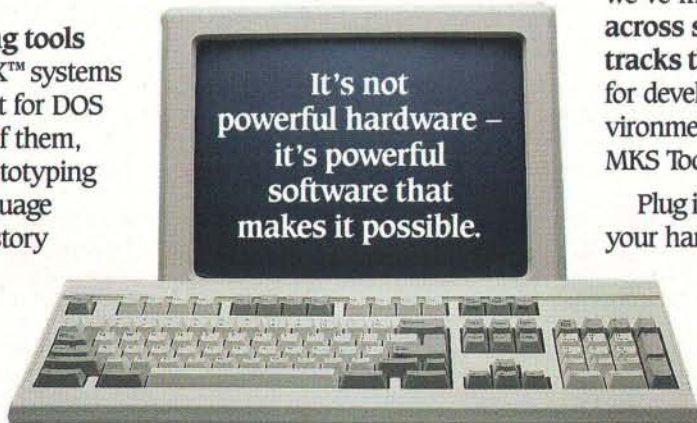

Price: DOS \$249, OS/2 \$349, DOS & OS/2 \$399, Upgrade \$69 (DOS only). Call for LAN and site license prices.



To order, call MKS at 1-800-265-2797 (continental U.S. only) or (519) 884-2251; Fax (519) 884-8861
30-day money-back guarantee.

MKS 35 King Street North
Waterloo, Ontario
Canada. N2J 2W9

MKS and MKS Toolkit are trademarks of Mortice Kern Systems Inc. UNIX is a registered trademark of Unix System Laboratories, Inc.

Circle 130 on Inquiry Card.



Photo 3: A Topas storyboard showing the opening title animation for the "Inside the BYTE Lab" video.

reason is obvious: 3-D can turn the simplest video into a highly polished presentation.

The most direct use for 3-D is to create backgrounds. Unlike 2-D backgrounds, you have to worry about where the camera (point of view) is, where your lights are, and the arrangement of objects in 3-D instead of 2-D. The advantage is that while 2-D looks good, 3-D looks real. Instead of a graded background, for example, you can draw a rectangular object and place a light at the upper-left corner of it. That light affects both the background rectangle and any text or other objects you place in front of the rectangle.

When you use text in a 3-D package, you're not creating flat graphical shapes. Characters have depth, can reflect light, and can cast realistic shadows. By extruding your text, the letters take on a sculpted look, and the way light bounces off the surfaces created by an extrusion can make them easier to read.

While doing simple text and backgrounds in 3-D looks impressive, it's clearly not cool enough to justify the high cost of a 3-D package. (The exception is the Toaster, where 3-D is part of the basic package.) The most exciting use of 3-D is in animation.

If animation makes you think of Mickey Mouse, think again. Also, if you assume 3-D animation is out of your reach, you're wrong. Today's tools make 3-D animation available to anyone willing to invest some time in learning and practicing.

The reigning example of animation in corporate video is the flying logo, which is now so common that it's all but expected. For what it's worth, the cost to have a 3-D flying logo done professionally exceeds the price of any of the 3-D packages I'm about to discuss. In fact, building animation capability into your desktop video setup needn't involve additional hardware expense because most of the boards that control video decks during editing sessions can also handle animation.

I don't have the space here to launch into a detailed tutorial on 3-D, so I'll just mix technique and tools together. Say I want to create a flying BYTE logo, and since I'm animating anyway, I'll also create a tantalizing opener for my "Inside the BYTE Lab" video. The total length of the animation will be about 10 seconds.

I'll start with the Amiga this time. Release 2.0 of the Toaster refined its 3-D package, Lightwave 3D. The new, improved Lightwave 3D now does ray tracing, and while it's impressive stuff, ray tracing creates a serious problem for 3-D animation: time.

I need to digress here for a moment to talk about the time it

takes to do 3-D. Few things stress a CPU more than rendering a 3-D image, and the more realistic the scene, the longer it takes to render. If you want shadows, you increase the rendering time. If you want objects to show reflections of other objects, you add still more time. However, if you ray trace, adding refraction and lending awesome realism to reflections and shadows, you may run out of time.

NTSC video rolls by at 30 frames per second, so when you create animation, you generally have to do 30 renders for each second of video. A simple scene—rendered without shadows, reflections, or ray tracing—might complete in a few minutes on a fast machine. For my 10-second opener, using fairly low grade animation, I'm looking at 10 hours of rendering time. That's hardly "while you wait," and it gets worse: Shadows would probably double the time required, while ray tracing can easily require multiple hours or even days to render each frame. And while your video equipment is tied up doing animation, you can't use it for anything else; the 3-D program must have exclusive, constant control of the recorder, unless you're rendering to files on disk. The latter case often makes more sense and leads me to suggest again that you consider a multisystem facility, if not multipatform. That way, you can dedicate the fastest box in the house to your 3-D project, while continuing to use the rest of your facility to pull together the other elements of your video.

Back to Lightwave 3D. Like many 3-D systems, Lightwave 3D splits the work between two modules: You build objects in the modeler and then pass them to the renderer for layout and animation. I'm no great fan of Lightwave's modeler, but it works well enough, and you can import objects from other 3-D tools. The 3-D BYTE logo didn't give me much trouble. Oddly enough, the title text—which is usually easy—was the hardest part of the scene to construct. That's because Lightwave 3D doesn't do text per se. Instead, it has 3-D letter object files that you must individually load and place. Because of this, it took me far longer to build the scene in Lightwave 3D than with either the Macintosh or DOS platforms.

Once I had all the elements in the scene, the renderer's layout tool came into play. Lightwave 3D uses an interesting scheme that turns the mouse into a 3-D pointing device. It takes much getting used to, but when you get the knack of it, tooling around in 3-D space gets as easy as driving a car. Lightwave 3D is a *keyframe* animator. Simply stated, you arrange the objects in your scene the way you want them, and take a snapshot, or keyframe, of the scene. You then move objects around, taking keyframes as you go. At animation time, the renderer automatically smooths the movement of objects between keyframes. So, to move a rectangle from the lower-left to the upper-right corner of the screen in just 1 second, you'd place the rectangle in the lower-left corner; create a keyframe at frame 0; move the rectangle to the upper-right corner; and create a keyframe at frame 30 (1 second). When the animation is rendered, the rectangle will glide diagonally across the screen.

Lightwave 3D is extremely powerful and capable of creating effects such as explosions, fog, and morphing (i.e., the gradual changing of one shape to another). In addition to animating the movement of objects (including the camera and lights), you can animate light color and intensity and several other attributes. These effects can be expensive—in terms of time—to experiment with, but thankfully, Lightwave 3D offers a variety of low-resolution rendering modes that let you rapidly generate test animations. You can quickly see the paths followed by moving objects in a scene using the wireframe preview feature. Lightwave 3D can either render animation frames to disk or record them directly to tape. As each frame is rendered, the frame number

Where do the Gurus get their Programming Info?

More than 125,000 of them have turned to this book for theirs. Here's why:

"This book has enabled me to cut my source coding in half. It has been a real blessing." - U.B., NY; "This book is such a good reference and so complete and in-depth I keep it next to my system reference manuals and compiler manuals." - J. K., NE; "Best written PC language book I've seen." - A.R., OK; "Like this book; will save me lots of time on program development." - J.M., OH; "This is the first THOROUGH, easy to read book in my computer library!!" - T.K.; "This is the best reference book I have ever seen." - D.C., TX; "Excellent reference manual. It has more information than any other individual reference work." - T.S., NH; "It really helped me start programming seriously on the PC" - M.R., Israel; "I believe PC System Programming will be of great help to any professional programmer on the PC." - H.S., AL; "This book is the DOS reference. I recommend it to every serious PC programmer." - M.J.W., Australia; "The most valuable reference book I have ever read for IBM class computer programming on DOS." - I.B., CA; "This book is the closest thing to an indispensable book I have ever read." - L.B., CA; "This book is the best programming reference for assembly language hardware. It covers the PC's language; memory interrupts; Computer I have purchase with this rise my N. K., e been the book Ont - love the ses the System on the - very MO - book! "L.E., s great computer BIOS Great presents "This book helped Binary

PC Intern is a completely revised and expanded edition of our bestselling *PC System Programming* book. It's a literal encyclopedia for the DOS programmer. Whether you program in Assembly Language, C, Pascal or BASIC, you'll find dozens of practical, parallel working examples in each of these languages. **PC Intern** clearly describes the technical aspects of programming under DOS. More than 1300 pages are devoted to making DOS programming easier, faster, better and more productive. **PC Intern's** new information for software developers includes:

- PC memory organization
- Using extended and expanded memory
- Hardware and software interrupts
- COM and EXE programs
- Handling program interrupts in BASIC, Turbo Pascal, C and Assembly Language
- DOS structures and functions
- BIOS interrupts
- Programming video cards
- TSR programs
- Writing device drivers
- Multi-tasking
- Programming for Networks and much more...

1320 pages with companion diskette containing 2.8 MB of compressed source code.

#B145 ISBN 1-55755-145-6 \$59.95

Available at most B. Dalton, Waldensoftware, Software Etc., Crown Books and other bookstores nationwide.

In the UK contact Computer Bookshops 021-706-1188.

In Australia contact Pachronics 02-748-4700.

Abacus

5370 52nd Street SE • Grand Rapids, MI 49512

Order Toll Free: 1-800-451-4319 Ext.26

Phone: (616) 698-0330 • Fax: (616) 698-0325

In US and Canada add \$5.00 postage. Foreign orders outside North America add \$20.00 surface rate per book.

Circle 69 on Inquiry Card (RESELLERS: 70).

New Revised Edition-

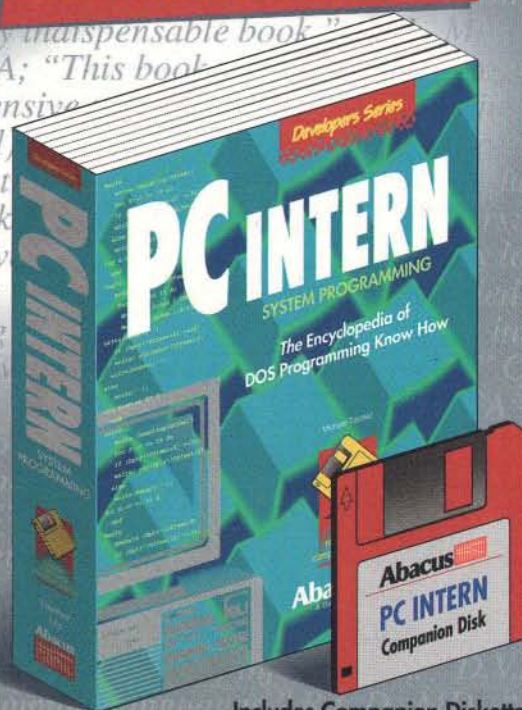

Includes Companion Diskette with complete Assembly Language, C and Pascal source code listings and programs.

For fast delivery Order Toll Free 1-800-451-4319 ext. 26, or FAX (616) 698-0325

Yes, please rush me () copies of PC Intern @ 59.95 each

Yes, please send your new complete book catalog.

Apply to my: Visa Master Card Am.Express / I have enclosed a check / M.O.

MI residents add 4% sales tax. CA residents add 7.25% sales tax. In US and Canada add \$5.00 postage. Foreign orders outside North America add \$20.00 surface rate per book.

Card#: _____ Expires: _____

Signature: _____

Name: _____

Company: _____

Address: _____

City: _____ State: _____ Zip: _____

Phone#: _____ Dept. B6

and the rendering time appear on the Amiga's screen to help you gauge your progress.

Playing Favorites

The Mac has a wide variety of 3-D software available. I haven't picked my favorite yet, but I have the most experience with Electric Image's software package, ElectricImage, so I defer to it for most of my Mac animation work. It doesn't ray trace, but it does do image reflections (see below). It also includes Mr. Font, a tool that turns PostScript fonts into exquisite 3-D objects. ElectricImage can record directly to video using a number of animation controllers, including the Diaquest DQ-Animaq board used in the Multimedia Lab. It lets you animate just about any attribute, and the user interface is quite accommodating. My opening screen layout came together quickly in ElectricImage, and I found its materials preview, which lets you see an approximation of the color and shading properties you select on a small sphere, a great time-saver.

On the PC, I have a clear favorite: Topas, also from AT&T GSL. Topas is loaded with advantages, but I rank its fast rendering, integrated video-recorder control, rotoscoping, and reflections among my list of reasons for using Topas as much as I do. Rotoscoping is a wonderful thing: It maps moving video onto an object. Imagine that you have a model of a desk, with a framed picture of a dog standing in one corner. Partway through the scene, the picture comes to life, and the dog starts barking and running around the photo. You would use rotoscoping for that effect, and any video that you like could be mapped to the rectangle that represents the photo in the frame.

Unlike ElectricImage, Topas can create real reflections. ElectricImage lets you simulate reflections by mapping graphical image files to objects, but Topas scans the scene and lets objects carry reflections of each other. These reflections add time, of course,

but it incurs nothing near the overhead of ray tracing.

Like RIO, Topas has its own scalable, manipulable fonts; it also has a straightforward combination modeler/renderer. Topas has the widest selection of preview modes, covering everything from real-time wireframe previews to stationary storyboards and animated color flipbooks that let you see light, shadow, and reflections without waiting for a recorded animation. Photo 3 shows the Topas storyboard for the BYTE Lab video introduction. Needless to say, I had no trouble getting my opening sequence animated through Topas.

Making the Grade

The toughest part of putting together a desktop video setup is choosing from among a vast number of quality products. Perhaps it's just chance, or maybe it's a testament to the quality of AT&T GSL products, but my favorite 2-D and 3-D packages happen to come from the same company and to run on the same platform. I'm neither an AT&T GSL nor a PC bigot—I couldn't do without my Amiga and Mac—but the combination of RIO and Topas has served me remarkably well. I got up to speed faster with these because of their simple interfaces and quality documentation, and I built up my creative skills more quickly because of their versatility. I also got more "wows" from people for the graphics and animations I constructed in these packages.

That's not to say I use the PC exclusively—hardly. In producing the BYTE Lab video, I have called on each of the Lab's systems for various parts of the job. You'll get a taste of that in next month's installment, which will wrap up this series with discussions of audio and editing. ■

Tom Yager is the director of BYTE's Multimedia Lab. He can be reached on BIX as "tyager" and on the Internet at tyager@byteb.byte.com.

COMPANY INFORMATION

Adobe Systems, Inc.

(Photoshop, Illustrator)
1585 Charleston Rd.
P.O. Box 7900
Mountain View, CA 94039
(800) 833-6687
(415) 961-4400
fax: (415) 961-3769

Circle 976 on Inquiry Card.

AT&T Graphics Software Labs

(RIO, Topas)
3520 Commerce Crossing, Suite 300
Indianapolis, IN 46240
(317) 844-4364
fax: (317) 575-0649

Circle 977 on Inquiry Card.

Diaquest, Inc.

(PC, Mac, and Amiga VTR
controller cards)
1440 San Pablo Ave.
Berkeley, CA 94702
(415) 526-7167
fax: (415) 526-7073

Circle 978 on Inquiry Card.

Electric Image, Inc.

(ElectricImage)
9690 Telstar Ave., Suite 225
El Monte, CA 91731
(818) 444-1819
fax: (818) 444-1135

Circle 979 on Inquiry Card.

Newtek, Inc.

(Video Toaster)
215 Southeast Eighth Ave.
Topeka, KS 66603
(913) 354-1146
fax: (913) 354-1584

Circle 980 on Inquiry Card.

Ray Dream, Inc.

(JAG)
1804 North Shoreline Blvd.
Mountain View, CA 94043
(415) 960-0768
fax: (415) 960-1198

Circle 981 on Inquiry Card.

Symantec Corp.

(More)
10201 Torre Ave.
Cupertino, CA 95014
(800) 441-7234
(408) 253-9600
fax: (408) 253-4092

Circle 982 on Inquiry Card.

Truevision, Inc.

(NuVista+, ATVista)
7340 Shadeland Station
Indianapolis, IN 46256
(317) 841-0332
fax: (317) 576-7700

Circle 983 on Inquiry Card.

▶ FrameMaker.

The richest blend in document publishing.

▼ *FrameMaker 3.0 with conditional text running on a Macintosh.*



▶ *FrameMaker 3.0 under the NeXTStep interface on this NeXTstation Color.*



◀ *FrameMaker 3.0 running under Microsoft Windows on a 386 PC.*



▲ *FrameMaker 3.0 on a SPARCstation under Sun's OPEN LOOK interface.*

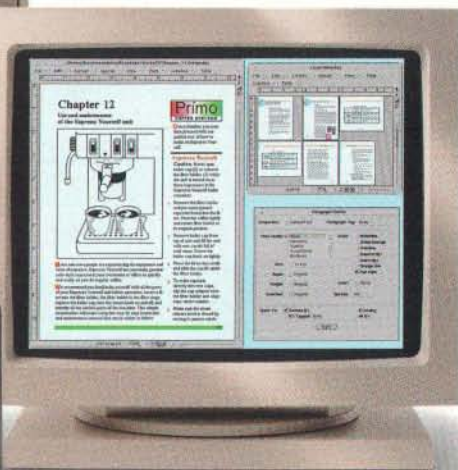

Frame Technology® has a unique formula for publishing everything from simple memos to long, structured documents: FrameMaker.®

▶ FrameMaker blends into one integrated, easy-to-use program all the essentials of publishing: Authoring, editing, graphics, page layout, and production. Even math equations and hypertext.

▶ And FrameMaker 3.0 blends in new robust and exclusive features. Like conditional text capabilities to help you generate and maintain multiple versions of a single document. And an integrated, multipage table editor.

▶ FrameMaker is the perfect complement to all your hardware, because it runs on more platforms than any

other publishing program. Including PCs running SCO Open Desktop or Microsoft Windows, Macintosh, Apollo, DEC, HP, IBM, NeXT,™ Sun, and a host of other UNIX platforms—with complete file compatibility. So your workgroups not only share files, but also their skills and expertise.

▶ For a taste of FrameMaker 3.0, call 1-800-U4-FRAME Ext. 961 for a **free** guide to integrating document publishing, and the name of your nearest reseller. And start brewing your own blend of publishing.

 **Frame**™

It's completely rational.

Microsoft® C/C++ 7.0 now includes the Windows™ operating system version 3.1 SDK. For only \$139, it's hard to believe this development kit is so complete. We're talking all the latest technology programmers have told us they want.

But you're still skeptical. You're asking yourself what is missing? Well, here's an admittedly long-winded list of what's included.

Object linking and embedding. Great for creating applications that share diverse types of data, like text and graphics. An application that supports OLE can cooperate with other OLE applications, even those from another vendor.

Pen computing APIs. Everything you need to create compelling applications for the next generation of pen computers. There are over 300 pages of documentation that give you the basic elements of Windows for Pen Computing.

Multimedia APIs. Our newest media control interface. You can incorporate animation, audio and video capability using third party devices and drivers. (It's the next best thing to virtual reality.)

Windows Debugging Version. Traps the most troublesome UAES and helps you create more stable, robust applications. Contains GDI, KERNEL, and USER modules.

GUI Setup Toolkit. It will make hammering out a custom Windows-based setup program as simple as writing a script file.

Microsoft Foundation Classes. Now you can use the same building blocks we're using to build future versions of the Windows operating system. A rich set of 60 recyclable object classes provides logical order to more than 500 functions of the Windows API. Menus, GDI, OLE 1.0 and advanced diagnostics sup-

port are included. Tasks such as registering Windows' classes, building message loops, and managing device contexts are automatic.

Sample code. Over 75,000 lines.

Zoomin. A nifty tool for magnifying portions of a screen to help identify paint problems and other screen-related issues.

Heapwalker. Examine the global heap and local heaps used by active applications and dynamic-link libraries in your system.

Editors. And plenty of them. Dialog Editor lets you add, modify, and delete custom controls as you design and test dialog boxes on-screen. Image Editor modifies icons, bitmaps and cursors. Font Editor alters existing faces and creates new ones. Hotspot Editor creates and edits hypergraphics or bitmaps in one or more hotspots.

Spy Tools. Pssst. They make it possible to monitor Mouse, input/output from Windows, DDE and other messages between one or more Windows-based applications. You can also examine message parameter values.

Stress. Allows you to consume system resources for low-resource stress testing. Acquirable resources include the global heap, user heap, GDI heap, disk space and file handles. (Less job stress for you.)

Wdeb386. Now test and debug dynamic link libraries and Windows-based applications running in standard or 386-enhanced mode.

Multi-resolution bitmap compiler. Combine color and monochrome bitmaps with different resolutions into a single graphic.

Help Compiler. Create Help systems for applications that will take advantage of the new Windows 3.1 Help engine. Both context-sensitive

and topical searches of Help files.

Compiler features. Unrestricted pre-compiled headers for speedy throughput. Explicit or automatic inlining of any C/C++ code for faster executions. Compressed code for size reductions.

CodeView® Debugger. This window-oriented debugger is a powerful, easy-to-use tool for analyzing MS-DOS® or Windows-based program behavior. Test the execution and examine data all at the same time. Display any combination of variables—global or local—while you halt or trace a program's execution. Versions for dual and single monitor debugging, even in a window, are supported.

Source Profilers. Optimize the performance of all your MS-DOS-based or Windows-based applications. Analyze your program to find code inefficiencies.

Whew! If you were to get all of this separately, it would cost many hundreds of dollars. And definitely will in the very near future.

On the other hand, if you use a Microsoft or any other C/C++ product, and order an upgrade before June 30, 1992, it's yours for \$139. That includes over 5,000 pages of C/C++ 7.0 documentation plus the entire Windows 3.1 SDK online documentation. We'll also throw in a free copy of Qualitas® 386-Max™ for MS-DOS-based development.

And if you want the Windows 3.1 SDK documentation in hard copy (over 5,000 pages), it's yours for an additional \$150.

Look. You can defy the logic of thinking programmers everywhere and pass up this historic offer. Or you can call your reseller. Or just call us at (800) 541-1261, Dept. B18.

Microsoft®

It defies logic.

C++ 7.0 & WINDOWS 3.1 SDK

NOW

\$139.00

RD

IRIS Indigo.

An excellent example

of smaller, faster,

cheaper, better.



Desktop, RISC/PC, under \$10,000 ... Silicon Graphics.

It was bound to happen. We've taken everything we've learned about visual computing and built it into powerful systems that everyone can afford – the IRIS Indigo™ family.

They pack the hot power of workstations and glide by at the cool price of PCs. And they're remarkably versatile – going from conceptual design to manufacturing – from fast 2D drafting through solids modeling – all with our powerful, renowned graphics.

They're standards-based machines with all the hooks and connections to fit easily with other systems. And with a starting price under \$10,000, they bring unprecedented graphics power to more desks for less money.

See them for yourself. Get our free 20-page full-color capabilities brochure, and find out where to check out the IRIS Indigo family as well as our full line of servers and supercomputers.

Fax a request with your name and complete address to U.S. (415) 962-1654* attn. dept. 27.

* The international operator can supply you with your country-specific code.

Systems Integration magazine says IRIS Indigo has, "the best price/performance ratio we've seen on a workstation – or any product for that matter." They've also been given the **BYTE** Award of Distinction and the *Digital Review* Editor's Choice.

Copyright © 1992 Silicon Graphics, Inc. Silicon Graphics, the Silicon Graphics logo and IRIS are registered trademarks, and IRIS Indigo is a trademark of Silicon Graphics, Inc. All other registered and unregistered trademarks are the sole property of their respective owners.



SiliconGraphics®
Computer Systems

OOPS via DDE

Don't bet the ranch on an OOPS;
try DDE first for a gentler transition

KEVIN KORNFELD AND KEVIN GILHOOLY

One of the hottest topics in business and academia today is the OOPS (object-oriented programming system). The OOPS promises far-reaching improvements in how people design, develop, and maintain software by offering a long-term solution to problems and concerns that have existed since the dawn of software development: lack of code portability and reusability, code that is difficult to modify, long development cycles, and nonintuitive coding techniques.

An OOP language attacks these problems. It has three basic characteristics: It must be object-based, class-based, and capable of class inheritance. Many languages meet one or two of these criteria; far fewer meet all three. The stumbling block is usually inheritance. (For a primer of basic OOPS terminology, see table 1.)

Objects, being encapsulated units, are inherently portable (theoretically), while inheritance allows the reusability of OOPS code. It is easier to modify existing code, because objects don't interact except via messages; thus, a coding change in one object won't affect the operation of another object, as long as the respective methods remain intact. Code reusability reduces the time spent in development, and it makes software development more intuitive, because people naturally think in terms of objects rather than in terms of software algorithms.

Nirvana Has Weeds

An OOPS may sound like a virtual nirvana. The problem, however, comes in implementing such a system. Many companies hear about the benefits of an OOPS and commit large amounts of resources to it. Then they begin to realize that they have effectively imposed a new culture that is as foreign to today's programmers as trees are to the desert dweller. Specifically, the following issues come up time and time again.

- *Long learning curves.* An OOPS views the world in a unique way. It involves conceptualizing all the elements of a program—from subsystems to data—as objects. All communication between objects must be in the form of messages. This is not how non-OOPS programs are written today; in making the transition to OOPS, most programming staffs need complete retraining before they can use one.

- *Language dependencies.* Despite the conceptual portability of OOPS objects, in practice several dependencies still exist. Many OOPS languages are currently competing for dominance in the marketplace. Changing the OOPS implementation language is not a trivial undertaking. For example, C++ supports the concept of multiple inheritance, while Smalltalk



PRIMER OF OOPS TERMINOLOGY

Table 1: To be considered object-oriented, a programming language must have three basic characteristics: It must be object-based, class-based, and capable of class inheritance. Other characteristics often found in full-blown object-oriented languages are also listed.

Term	Definition
Object	The data and access to it.
Class	A template used to create new objects. A class encompasses both data and methods.
Instance	One implementation of a class template. An object is an instance of a class, containing the data-interface implementation.
Instance variable	An object's data.
Encapsulation	The representation of an object and its data in discrete units. The isolation of one object (and its data) from other objects.
Method	An operation that performs data access.
Messages	The mechanisms by which objects communicate. A message lets methods send or receive data. The messages an object responds to form the basis of its protocol.
Protocol	The messages an object responds to.
Polymorphism	A fundamental concept of OOPS: the ability to send the same message to objects of different classes. These objects would all receive the same global message but could respond to it in varying ways; for example, a "+" message to an integer object means addition, whereas, to a string object, it might mean concatenation.
Inheritance	The ability to pass along class properties from one class to another. The resulting subclass has all the properties of its parent, which is the superclass.
Subclass	A class having all the properties of its parent class, as well as localized changes.
Superclass	A parent class of a subclass.
Multiple inheritance	The ability to inherit from multiple parents.
Object-oriented language	An object- and class-based programming language that is capable of class inheritance.

does not. Thus, the choice of language has major design ramifications.

- **Class determination.** A class is a template that you use to create new objects. Therefore, it's important to create the correct set of classes for a project. Unfortunately, class definition is more art than science. Although there are many predefined class hierarchies, you must usually go beyond them to create application-, industry-, or company-specific classes. Then in 6 months or a year, you may realize that the classes you established are not feasible. You may need to restructure the entire class hierarchy, totally devastating the original schedule.

- **Performance.** In a system where *everything* is an object and *all* interaction is via messages, messaging traffic has some obvious ramifications on performance. As technology advances, with microprocessor speed and power and memory size all increasing, the

DDE MESSAGES

Table 2: DDE is an open-ended, language-independent, message-based protocol that lets applications exchange data or commands in any mutually agreed-on format. The basic concept is that of a conversation between client and server, with the client being the initiator.

Message	User	Description
INITIATE	Client	Begins a conversation.
INITIATEACK	Server	Acknowledges a conversation initiation.
REQUEST	Client	Requests data from a server.
DATA	Server	Sends data to a client.
EXECUTE	Client	Requests command execution.
ADVISE	Client	Establishes a hot link with a server. (The server agrees to notify the client when data changes.)
UNADVISE	Client	Terminates a server's hot link.
POKE	Client	Sends data to a server.
ACK	Client or server	A positive or negative acknowledgment of a previous request.
TERMINATE	Client or server	Terminates a conversation.

situation will greatly improve. But in today's environment, an OOPS application design that isn't tuned for performance probably won't be commercially feasible.

Ideally, there would be a way to address these problems effectively while still garnering the short- and long-term benefits of an OOPS development strategy. A methodology would exist that would be easy to learn (and intuitive), language independent, and simple to restructure and wouldn't create a performance drain on the system.

DDE Fills the Bill

In the OS/2 PM (Presentation Manager) and Windows operating environments, a message-based protocol allows applications to exchange information. DDE is open ended, allowing two applications to exchange data or commands in any mutually agreed-on format. The key is that the operating system supports the protocol. As long as the language you use supports the operating system's APIs for DDE, the protocol is language independent. If the operating environment supports DDE, applications using DDE need only interface with the operating system, not with each other. (Table 2 shows DDE's messaging protocol.)

The basic concept behind DDE is that of a conversation. There are two applications: a client and a server. The client initiates and controls the conversation flow, and the server responds to requests from the client. Applications often act as both client and server, carrying on multiple conversations simultaneously. As long as you understand the basic conversation verbs, you can establish interapplication communications at will.

The protocol delineates three established hierarchical layers—application, topic (one per conversation), and item—that control the subjects for DDE communications. The application

**WHERE
ON EARTH
CAN YOU CALL US
FOR AS LOW
AS \$20
AN HOUR?**

Now you can connect with BIX, the on-line information service, at a fixed hourly rate from many cities around the world. Compared to packet switching networks, this saves you up to 75% depending on your location. There's

no application process. No character or packet fees. No extra charge for 2400 baud. And you're billed directly by BIX for your phone usage.

Just call the access number nearest you, log on, and the world of BIX is at your fingertips.

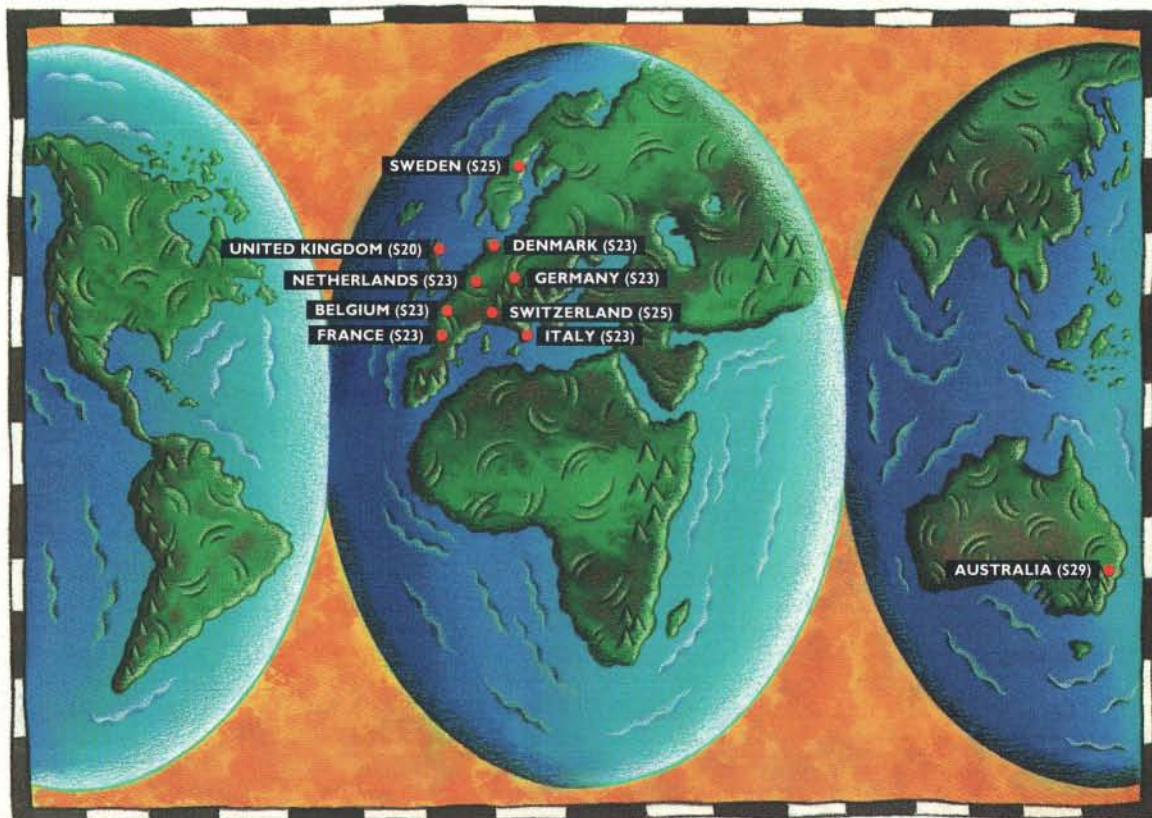

BT Tymnet Access Information: (All amounts are U.S. dollars)

AUSTRALIA (\$29/hr): MELBOURNE (3) 4162146; SYDNEY (2) 290-3400 **BELGIUM** (\$23/hr): BRUSSELS (2) 725-5060 **DENMARK** (\$23/hr): COPENHAGEN 31-18-63-33 **FRANCE** (\$23/hr): PARIS (1) 47719133, (1) 46027003, (1) 46025750, (1) 46025500; LYON (7) 8478144 **ITALY** (\$23/hr): MILANO (2) 66-98-30-04 **NETHERLANDS** (\$23/hr): ALKMAAR (72) 155190; AMSTERDAM (20) 6610094; EINDHOVEN (4902) 45530; THE HAGUE (70) 3475032, (70) 3814641; ROTTERDAM (10) 4532002 **SWEDEN** (\$25/hr): STOCKHOLM (8) 294782 **SWITZERLAND** (\$25/hr): GENEVA (22) 782-9329; ZURICH (1) 730-9673 **UNITED KINGDOM** (\$20/hr): BIRMINGHAM (21) 6326636; BRISTOL (272) 255392; CAMBRIDGE (223) 845860; EDINBURGH (SCOTLAND) (31) 3132172; LEEDS (532) 341838; LONDON Baynard House (71) 4898571, Ealing (81) 5667260 **GERMANY** (\$23/hr): COLOGNE (221) 210196; FRANKFURT (69) 666-8131, (69) 666-4021; MUNICH (89) 350-7682

To learn more about BIX see our other ad elsewhere in this magazine.

OOPS/DDE MAPPING

Table 3: The major concepts of an OOPS map directly to the DDE protocol. DDE can meet the requirements for an object-oriented language, although it doesn't have well-established structures for them. Although the DDE provides short-term advantages, it won't replace a full-blown object-oriented language in the long term.

OOPS	DDE
Object	Application/topic pair.
Method	Item.
Class	The grouping of an application and a topic with items.
Inheritance	The establishment of identical groupings.
Multiple inheritance	The establishment of groupings with mixed topics and items from multiple applications.
Polymorphism	Identically named items for various applications.

layer is typically what one application would establish for itself. For example, a database-interface application (DBSERVE) might have its supported databases as its topics, and various SQL (Structured Query Language) commands (e.g., SELECT and RETRIEVE) as its items. Restructuring or altering the DDE interface is as simple as changing topics or items. In terms of performance, DDE messages don't carry any more overhead than other operating-system messages do.

By taking the major OOPS concepts and mapping them to the DDE protocol, you can establish a table of correlations (see table 3). In fact, a DDE implementation can qualify as an object-oriented language: It can be object- and class-based and capable of establishing class inheritance. In practice, this means that a system can take advantage of the OOPS structural methodology and still let people write in their favorite language, as long as the language supplies the appropriate DDE API.

In the PM and Windows environments, you would write the applications as processes and send the DDE messages between system windows, each window with its own handle.

Since handles are a system resource, you could run out of them in a large DDE implementation (i.e., where many DDE processes are running at once). However, in a typical commercial environment, a 32-bit operating system would probably eliminate this concern.

One benefit of a DDE implementation is that it allows a staged migration between software development cultures and languages. For example, in a COBOL or C shop, programmers could write application

Many companies hear about the benefits of an OOPS and commit large amounts of resources to it. Then they realize that an OOPS is foreign to many of today's programmers. Using DDE as an enabler eases entry into the OOPS world, permitting management to move forward cautiously without betting the ranch.

ENCAPSULATED OBJECTS

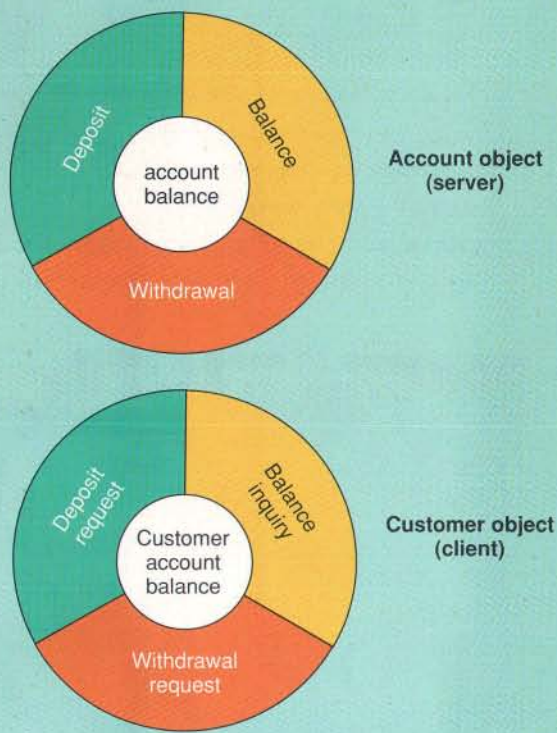

An example of an OOPS implementation through DDE is a bank transaction-processing system. Both client (Customer object) and server (Account object) are encapsulated objects (i.e., the client can only access the Account object through the server). The system uses DDE as the message protocol for all accesses.

processes in the familiar language but use DDE constructs to communicate and synchronize with other processes, creating a framework for an object-oriented system. If a small group of programmers wanted to program their application processes in Smalltalk or C++, they could do so independently. Thus, although only a few processes in the system would be written in a "true" OOPS language, the entire system would be an OOPS right from the start.

Banking on OOPS and DDE

One common example of an OOPS implementation that can be implemented via DDE is a bank transaction-processing system (see the figure). Listings 1 and 2 show a server (an Account object) and a client (a Customer object), respectively, in DDE pseudocode. Both client and server are encapsulated objects (i.e., the client can only access the Account object through the server). The system generates the Customer object when someone tries to access the server using an on-line teller system, an ATM (automatic teller machine), or some other remote banking service.

Regardless of the type of access, the system uses the same messaging protocol: DDE. A particular Customer object does not necessarily require all of the server's functionality; for example, an ATM transaction might not need the Deposit object.

Another example of a DDE OOPS implementation is a cooperative-processing data-retrieval system. You can implement the

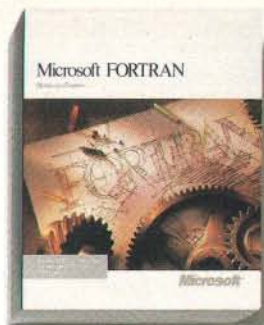

Windows helps FORTRAN users create bigger apps.

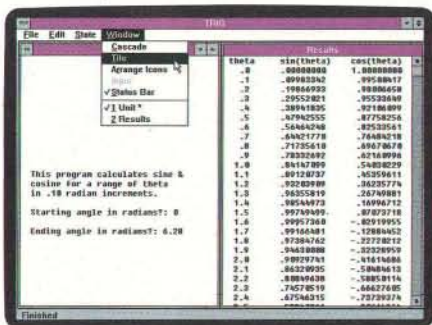

The Microsoft Windows graphical environment lets you have multiple windows in your FORTRAN applications. This means that you can resize and scroll input and output displays to view data...

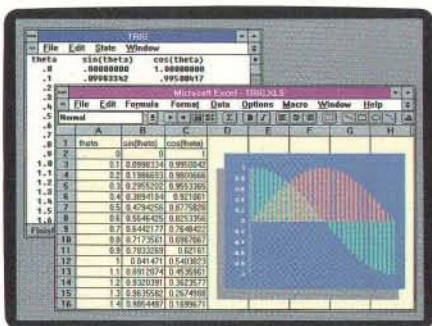

...and to analyze data, simply cut and paste your FORTRAN output into programs such as Microsoft Excel for Windows and you can view it instantly in graphical form.

With the new Microsoft® FORTRAN Professional Development System version 5.1, your existing code taps into the power of the Microsoft Windows™ graphical environment. FORTRAN 5.1's new QuickWin library lets you develop 16-bit apps that access greater memory than ever before – breaking the 640K barrier on 286 and 386 machines.

You can use the FORTRAN QuickWin library to take advantage of multiple I/O windows, multitasking, and cut and paste. Or write FORTRAN routines called from mixed-language Windows apps. And FORTRAN 5.1 has Programmer's WorkBench, with a new CodeView® debugger and Source Browser.

To see the advantages of bigger, multi-windowed 16-bit applications, give us a call at (800) 541-1261, Department R34 and order your FORTRAN update today.

*As used herein, "DOS" refers to MS-DOS or PC-DOS operating systems. © 1991 Microsoft Corporation. All rights reserved. Printed in the U.S.A. Inside the 50 United States, call (800) 541-1261, Dept. R34; outside the 50 United States, call (206) 936-8661. Customers in Canada, call (416) 568-3503. Microsoft, MS-DOS, OS/2, CodeView and the Microsoft logo are registered trademarks and Windows and Making it all make sense are trademarks of Microsoft Corporation.

PROGRAMMER'S TIPS

Key Features

- Create Windows .DLLs in FORTRAN using new or existing code.
- QuickWin Features:
 - QuickWin child windows are easily created using the OPEN statement.
 - User-defined positioning and titles for child windows.
 - Automatically generated scroll bars for output that extends past a single screen.
- CodeView debugger supports DOS*, Windows-based and OS/2* applications.
- Extended CodeView debugger for large DOS programs.
- Complete online documentation for the FORTRAN language and all compile and link switches.
- DOS and OS/2 run-time libraries are compatible with other Microsoft languages.
- Floating-point support includes co-processor, emulation, and alternate math libraries.
- 100% ANSI 77 compatibility and numerous IBM® VAX® and ANSI 8X extensions.
- New BYTE keyword emulates VAX data types.
- Language Extensions include DOUBLE COMPLEX variables, precision and maxexponent inquiries.

- Use the new /MW option with the FL command to invoke the QuickWin library. For example: "FL/MW MYAPP.FOR" is all it takes to make MYAPP a Windows-based program.
- Use the ALLOCATE statement to dynamically size arrays and to access more than 16MB of memory on a 386.*

Microsoft

Space - Savers

NEW



Stand-Alone LCD Monitor

£799.00

This 10" black on white monitor is easy-to-read, yet compact. Resolution is 640x480 for sharp, flicker-free image. Sharp's high refresh rate, triple supertwist nematic technology with back lighting provides a super bright, low radiation screen with a wide viewing angle. The adjustable monitor base is only 29x14 cm. It lets you mount the LCD monitor on vertical surfaces or fold for transport. Comes with 1.5 m cable and VGA adaptor card. No external power required. IBM AT compatible.

NEW
PRICE
ONLY
£79.00



Popular Space-Saver Keyboard

£79.00

First successful alternative to conventional keyboard saves 60% desk space with a foot print of 27.3 x 15.2 cm. Has full travel tactily responsive keys with standard left-right spacing for easy touch typing. 100 keys, compatible with IBM XT/AT PS/2. Many language versions available.

9" VGA Monochrome Monitor

£189.00

640 x 480 resolution black on white screen with a foot print to match the Space-Saver Keyboard of only 25.0 x 25.7 cm. Tilt and swivel stand. No adaptor card included.

To Order In Europe Call 44-306-76718

Fax 44-306-76742

1 year warranty on all products shown. Order direct from stock with 15 day full return privileges. Visa, Master/Eurocard charges and COD accepted. OEM and reseller volume discounts available.

Also Stocked & Serviced in: AUSTRALIA Tel 2-908-2777 • Fax 2-908-2331

DATALUX

First Choice In Space-Saver Peripherals

Euro House • Curtis Road, 11 Old Water Yard • Dorking, Surrey
UNITED KINGDOM, RH41EJ • Phone 306-76718 • Fax 306-76742



OOPS VIA DDE

Listing 1: In this DDE pseudocode for the Account object, Bank Name and Account Number define the server object. Each specific account generates a different Application/Topic pair. Item lists methods for the Account object. Both client (see listing 2) and server are encapsulated objects.

```
Begin Definitions
  Application = 'Bank Name'
  Topic = 'Account Number'
  Item = 'Balance', 'Deposit', 'Withdrawal'
End

Initialization

Do Forever
  Receive Message

  Case 'Initiate' // 'Initiate' DDE message
    Check application ('Bank Name') and topic
      ('Account Number')
    If available
      Send 'ack'
    Else
      Send negative 'ack'
    Endif

  Case 'Request' // 'Request' DDE message

    Case 'Balance'
      If valid client
        Send balance data for account
      Else
        Send negative 'ack'
      Endif

    Case 'Deposit'
      If valid client
        Update balance data for account
        Send 'ack'
      Else
        Send negative 'ack'
      Endif

    Case 'Withdrawal'
      If valid client
        Validate withdrawal amount
        If ok
          Update balance data for account
          Send 'ack'
        Else
          Send negative 'ack'
        Endif
      Else
        Send negative 'ack'
      Endif

  Case 'Terminate' // 'Terminate' DDE message
    If valid client
      Send 'terminate'
    Endif

Enddo
```

system on a workstation where it interacts with up to five mainframe sessions, sending or receiving data, as well as directly with the workstation user. The workstation has local data and file storage and can write reports, chart graphs, and send data to a spreadsheet.

To establish such a system, you divide the functionality into processes, each designed to handle a different function: a communications server, a database server, a file server, five mainframe servers, an external applications server, a service provider (for reports and graphs), and a main applications router. A true

WE'RE ONLINE. AND IN LINE WITH YOUR OBJECTIVES.

BUSINESS WEEK

AEROSPACE DAILY

AIRPORTS

AVIATION DAILY

AVIATION WEEK &
SPACE TECHNOLOGY

BIOTECHNOLOGY NEWSWATCH

BYTE

CHEMICAL ENGINEERING

CLEAN-COAL/SYNFUELS LETTER

COAL WEEK

DATA COMMUNICATIONS

ELECTRIC UTILITY WEEK

ENGINEERING NEWS-RECORD

HAZARDOUS WASTE BUSINESS

INDEPENDENT POWER REPORT

INDUSTRIAL ENERGY BULLETIN

INSIDE ENERGY/
WITH FEDERAL LANDS

INSIDE F.E.R.C.

INSIDE N.R.C.

INTEGRATED WASTE MANAGEMENT

LAN TIMES

NUCLEONICS WEEK

POSTGRADUATE MEDICINE

PLATT'S INTERNATIONAL
PETROCHEMICAL REPORT

PLATT'S OILGRAM NEWS

PLATT'S OILGRAM PRICE REPORT

S&P'S EMERGING & SPECIAL
SITUATIONS

S&P'S REVIEW OF BANKING
& FINANCIAL SERVICES

S&P'S REVIEW OF SECURITIES
& COMMODITIES REGULATION

SECURITIES WEEK

TECH TRANSFER REPORT

UTILITY ENVIRONMENT REPORT

THE WEEKLY OF BUSINESS AVIATION

UNIXWORLD

AND MORE...

When you need business information, why not get the total story, instantly! Word for word. The McGraw-Hill Publications Online database gives you just that. Unedited, full-text retrieval (except graphics) of articles exactly as they are published in McGraw-Hill magazines and newsletters.

Now you can get information on companies, people and products on any topic — pertaining to one particular industry, or search the entire McGraw-Hill library (over 35 leading publications online) for diverse editorial perspectives. Only McGraw-Hill, the world's foremost business information publisher, can deliver it all so completely — immediately! McGraw-Hill unabridged.

Access an entire universe of business information. Go online with our line. McGraw-Hill Publications OnLine. For more information, including our latest list of publications, contact Andrea Broadbent at (609) 426-5523. Or fax this coupon to (609) 426-7352.

Or send it to the address below.

Available through Dialog®, Dow Jones News/Retrieval®, NewsNet® and Nexis®.

McGRAW-HILL PUBLICATIONS ONLINE



Princeton-Hightstown Road
Hightstown, NJ 08520 U.S.A.

Please send me the complete 1992 list of your publications online.

BY

Name _____

Title _____

Company _____

Address _____

City _____

State _____

Zip/Postal Code _____

Country _____

Tel. _____

GO ON LINE WITH OUR LINE.

DADiSP 3.0

for Scientific Data Analysis

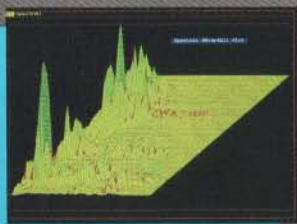

Engineering

Signal Processing & FFTs
Filter Design
Speech / Communications
Sonar & Radar
Electronics Design
Mechanical Test
Vibration Analysis

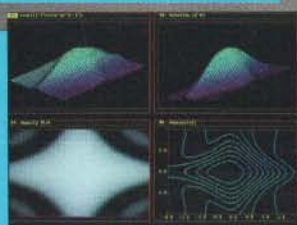
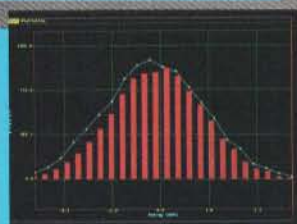

Image Processing

Medical Imaging
Satellite
Seismology
Terrain Rendering
Communications



Lab Automation

Data Acquisition
IEEE-488
Test & Measurement
Process Control
Quality Improvement
Manufacturing Test

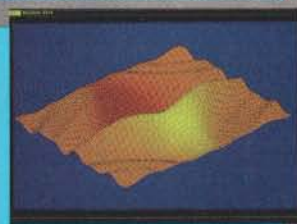

Science

Statistics
Experimental Design
Hypothesis Testing
Peak Analysis
Chemistry
Medical Research
Quality Management

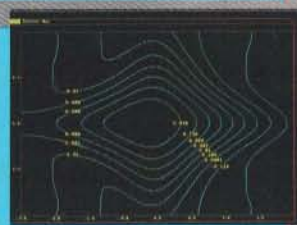

Matrix Processing

Inverse / Transpose
Eigen Values & Vectors
Matrix Math
2D FFTs and convolutions
3D and 4D Graphic Displays
Operations Research

CALL 1-800-777-5151

for your free DADiSP Trial Kit. DADiSP is available for SUN, HP, IBM, NeXT, DEC, Concurrent, and Silicon Graphics workstations, and of course, IBM PC compatibles.



DSP
Development
Corporation

One Kendall Square, Cambridge, MA 02139,
617-577-1133, FAX: 617-577-8211

Listing 2: In this DDE pseudocode for the Customer object, Application and Topic still refer to the server object (see listing 1). However, Item shows the methods for the Customer object, which is generated when you try to access an account using an ATM or other on-line banking service.

```

Begin Definitions
  Application = 'Bank Name'
  Topic = 'Account Number'
  Item = 'Balance Inquiry', 'Deposit Request',
        'Withdrawal Request'
End

// Search via Initiate message for server object.
Poll for server ('Bank Name', 'Account Number')

Do Forever
  Receive Message

  Case 'Balance Inquiry' // User-generated message
    Make inquiry with request message, item =
      'Balance'
    If negative 'ack'
      Display error message
    Else
      Report account balance
    Endif

  Case 'Deposit Request' // User-generated
    message
    Send deposit request with request message, item =
      'Deposit'
    If 'ack'
      Display ok message
    Else
      Display error message
    Endif

  Case 'Withdrawal Request' // User-generated
    message
    Send withdrawal request with request message,
      item = 'Withdrawal'
    If 'ack'
      Dispense money
    Else
      Display error message
    Endif

  Case 'Terminate' // 'Terminate' DDE message
    If valid conversation
      Send 'terminate'
    Endif

Enddo
  
```

production system would, in all probability, also contain an additional process for error handling and/or system diagnostics, and it might well take more than one process to implement any of these services. In the OS/2 environment, all the processes would probably involve multiple threads of program execution. None of these considerations, however, has a direct impact on the architectural framework of the DDE environment.

All processes can have one application level, since all are part of a single production application. The additional considerations then become what topics or items to have and whether each process should function as a client, a server, or both. The following is a description of each process.

- *Communications server.* This process acts as the gateway, or *router*, to the mainframe server processes. It determines which mainframe the data resides on (or should be routed to) and

Your network buy for today's business technology market.

McGraw-Hill TechNet

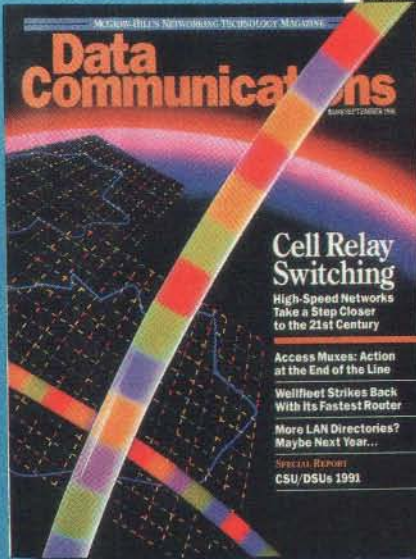
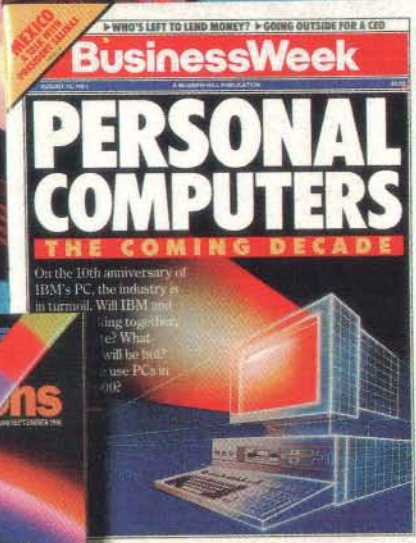

McGraw-Hill Magazines. Your Best Business Partners.

- 4- Architectural Record ■ 7- A/C Flyer, Aviation Week & Space Technology, AW & ST China Quarterly, AW & ST USSR, Business & Commercial Aviation, World Aviation Directory and Buyer's Guide
- 20- Business Week, Business Week China, Business Week Hungary, Business Week International, Business Week USSR
- 28- Chemical Engineering ■ 32C- BYTE, Data Communications, Data Communications International, LAN Times, UnixWorld
- 39-Electrical World ■ 41- ENR, Construction News Publishing Network (11 magazines, 4 newspapers)
- 46- Global Finance ■ H6- The Physician & Sportsmedicine, Postgraduate Medicine
- 114- Modern Plastics, Modern Plastics International ■ 117- Power, Power International



ACCSYS™ for PARADOX

C libraries
for joining forces.

- C Libraries to Paradox Tables
- Windows (DDL) and VisualBasic Support
- Multi-Platform/C Source Available
- Twice the Speed & Half the Size of Engine
- Full Network Support



FOR TECHNICAL DETAILS: 708/924-3030 DOC. NO. 889822

Copia International Ltd.

Wheaton, Illinois 60187 708/682-8898

IT PAYS BIG
TO MAKE
A SMALL
CONNECTIONLaptop/Notebook PC presentations on
a large screen color TV with the Model
701 Pocket Videoverter™

By connecting the Model 701 with any color television set, you're able to give a presentation or training program to a large audience with greater ease and clarity. The Model 701 also gives you the ability to create and customize video cassettes for VCR's. The promotional uses of video cassettes in today's market are endless. Call or write for specifications.

Model 701N (NTSC) or 701P (PAL)
include AC adaptor, cables and software **\$399**

TELEBYTE
TECHNOLOGY, INC.

270 E. Pulaski Road
Greenlawn, NY 11740
TEL: (516) 423-3232
FAX: (516) 385-8184
1-(800) 835-3298

CONNECT • COMMUNICATE • SUPPORT

OOPS VIA DDE

forwards the messages appropriately. Thus, the data source and destination are transparent at the workstation level. The communications server process needs to act as both client (to the mainframe servers and the applications router) and server (to the process sending or receiving data). Its topics and items would probably be similar to those on the mainframe servers (and most likely originally inherited from the communications server).

• *Database server.* This process handles data stored locally at the workstation. It is a resource controller, ensuring that the data update and retrieval for up to five mainframe sessions and an interactive terminal do not corrupt the information store and that errors in data transmission result in controlled rollback. This process acts only as a server and deals with data storage and retrieval, just as the communications server does, so it might inherit at least some of the communications server's topics and items. You can add or remove topics and items as required.

• *File server.* For convenience, local workstation files hold reports, data, graphs, and other user information. The file-server process controls file storage and retrieval and acts as a server. It probably has unique topics and items; thus, it doesn't inherit them.

• *Mainframe servers.* These processes deal directly with the mainframe sessions and often interact only with the communications server, thus acting only as servers. You can enable them to function with the database server as well.

• *External applications server.* This process sends data to a spreadsheet. You need a spreadsheet that understands DDE; the spreadsheet definitions largely determine the topics and items that the external applications server uses. The rest of the topics communicate with the client process.

• *Service provider.* This process functions as a server, handling requests from its clients for charts, graphs, reports, and other summary information. The service provider has unique topics and items.

• *Main applications router.* This process interacts with the user and accepts data input. It is a client for most of the other (server) processes.

Note that this outline does not contain a direct language dependency. A systems architect specifies the I/O for each process via DDE topics and items. As long as all programmers adhere to them, developmental activities center around the individual processes, leading to more manageable debugging scenarios. You can readily carry out systems tests using test drivers and other "stub" modules; this method allows rapid prototyping, since you can better isolate the problems and create stub modules to test various parts of the system.

Paving the Way

Using DDE as an OOPS enabler does not do away with the requirement for an object-oriented development language. DDE is not a programming language and does not have well-defined structures in place for establishing classes and inheritance. However, DDE allows you to apply existing technology and programming expertise.

The DDE approach eases entry into the OOPS world in a controlled manner, permitting management to move forward cautiously, rather than precipitously betting the ranch. DDE does the job today while paving the way for tomorrow. ■

Kevin Kornfeld is a senior marketing support representative for IBM's Software Vendor Systems Center (Roanoke, TX), and Kevin Gilhooly is a senior software engineer for the Computer Task Group. You can reach them on BIX clo "editors" or on Internet at kevink@dalhqic2.vnet.ibm.com and kgilhooly@mcimail.com, respectively.

WINDOWS, WINDOWS, EVERYWHERE

It's hardly news that almost everyone—with one or two notable exceptions—is jumping on the Microsoft Windows bandwagon. IDC (International Data Corp.) predicts that this year more than two-thirds of PC operating-system sales will be Windows, increasing to 77 percent in 1993. Microsoft says that it has sold 10 million copies of Windows so far.

Sales of Windows applications are setting records, too. The Software Publishing Association reports that, last year, sales of Windows applications increased by 196 percent over 1990; they were up an astounding 228 percent in the fourth quarter. Compare that to a 37 percent jump in sales of Macintosh applications and only a 6 percent rise in DOS application sales.

Each day brings announcements of new Windows programs. Some of these programs are just hastily conceived ports to Windows that add nothing more than a new interface and colorful icons and fail to significantly advance the application's ease of use or functionality.

Such window-dressing is becoming rarer, however, as new programs that were simply impossible to implement with a command-line interface are easy to learn and a joy to use when coupled with a GUI. As our special report on Windows points out, a user-friendly PC executive information system would be unachievable without a GUI. The same holds true for PC picture-editing applications that used to reside exclusively on Macs. And the pen extensions built into Windows will surely provide the foundation for a new class of applications.

Obviously, Windows 3.1 is not the end-all of GUIs. And, of course, Windows applications are not for everyone. But all it takes is seeing that new Windows application that you can't live without, and suddenly, you're hooked. ■

**Windows Meets
the Pen**
BY JON UDELL
159

Flying Windows
BY GREG LOVERIA
172

**A Few of Our
Favorite Things**
BY THE BYTE STAFF
188

**EIS Moves
to the Desktop**
BY JIM KINLAN
206

Image Magic
BY DANA HUDES
219

Ask Dr. Windows
BY STAN WSZOLA
232



Win.

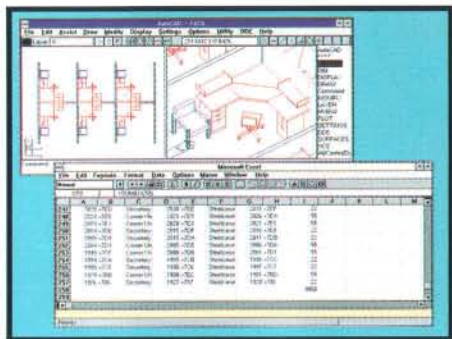

Using Dynamic Data Exchange, you can eliminate many repetitive tasks by linking AutoCAD to other Windows programs.

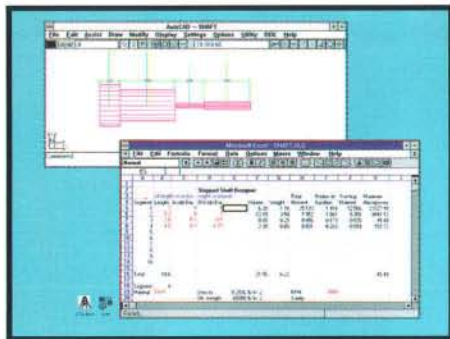

AutoCAD gives you the tools to link your drawings to spreadsheets. So you can explore the possibilities of parametric design.

when you update your spreadsheet, it can revise your AutoCAD drawing for you. See how long that takes you by hand.

With the new AutoCAD Extension for Windows, all the advantages AutoCAD users have been hoarding are now accessible to you. Now your files will be instantly transferable, and your work compatible with more than 650,000 other AutoCAD users. That

probably includes many of your clients and colleagues. In addition, you can use the power of programs like Microsoft Visual Basic™ or Borland Turbo C++™ to create custom CAD applications that fit the work you do.

Only \$99* for AutoCAD Release 11 Users.

Still on the fence? Call 1-800-445-5415 ext. 671 for the name of the nearest Authorized AutoCAD Dealer.

Runs On Windows.

when it comes to designing, making revisions and creating multiple views.

That's not all. AutoCAD on Windows has another way to make you more productive. It's called Dynamic Data Exchange (DDE). With DDE, information flows in both directions between AutoCAD and other Windows applications, like Microsoft® Excel® and Lotus 1-2-3®.

So when you update an AutoCAD drawing, new costs can be automatically computed on your spreadsheet. And

 **AUTODESK**

“YOU

We have to admit, you're persistent. Year after year, you've had the same objections to learning CAD. So we've finally decided to do something about them.

—| *Objection #1:* |—

“IT TAKES TOO LONG TO LEARN.”

Not any more. Now AutoCAD® runs on Windows.™

That means you get all the advantages of AutoCAD with-

out memorizing command names. Instead, you create your drawings by selecting simple Windows tools and icons. So your learning curve is much shorter.

—| *Objection #2:* |—

“I CAN'T DESIGN ON A COMPUTER.”

Windows helps change all that. Its intuitive interface and pull-down menus eliminate most of the repetitive key-boarding that makes computer work feel confining.

The AutoCAD Release 11 Extension for Windows also lets you move back and forth effortlessly between other Windows applications. So you can work the way that comes naturally to you. Create a brilliant drawing on



The intuitive Windows interface, tools and icons make AutoCAD far more accessible.

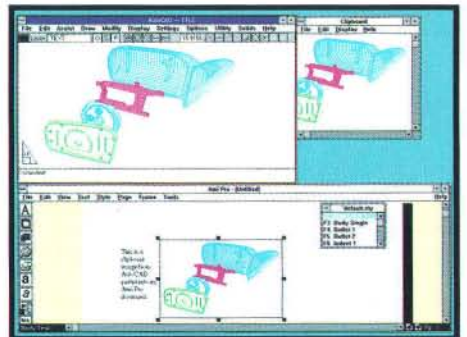

With the Windows clipboard, AutoCAD drawings are easily added to documents and presentations created on desktop publishing, paint, drawing or word-processing software.

Now AutoCAD

AutoCAD. Write the specs on your word-processor. Then use the Windows Clipboard to insert both pieces into a desktop publishing program, so you can polish your proposal.

—| *Objection #3:* |—

“I CAN WORK FASTER BY HAND.”

Okay, let's be honest about this. Maybe you and your pencil can beat the blazing speed of AutoCAD for rough sketching. But AutoCAD leaves your pencil in the dust

**The Creators
Of AutoCAD Have
Just One Thing
To Say To
All Those Who
Have Stubbornly
Refused
To Learn CAD.**



WINDOWS MEETS THE PEN

Write 2000 words by hand? Never again!

But the imminent marriage of the computer and the pen does bring many advantages.

I've often thought about my fifth-grade teacher, Mrs. Cloud, who vainly fought to improve my handwriting. Thanks to the typewriter—and then the computer—the skills she cherished no longer seemed to matter. The keyboard gave me blazing speed and total legibility; top that, Mrs. Cloud! Well, perhaps she'll have the last laugh. The imminent marriage of the computer and the pen brings us full circle.

Will pen-based systems transform the desktop computing landscape, or will they define a new form of mobile, ubiquitous computing? Both, I suspect. We want computers to melt into the woodwork, to weave themselves into the very fabric of our lives. That means they'll have to embrace the most basic tools of civilization—including the pen.

Whether pen computing demands revolutionary, or merely evolutionary, operating-system support is a topic of much debate at the moment. Go Corp.'s PenPoint takes the *revolutionary* tack. Designed from scratch to host an emerging breed of "pen-centric" applications, PenPoint breaks ground in a number of areas (see "The Point of the Pen," February 1991 BYTE).

Microsoft, in contrast, has taken the *evolutionary* approach. The Windows 3.1 SDK (Software Development Kit) ships with the tools, libraries, and drivers that transform Windows 3.1 into a pen-based operating system called Windows for Pen Computing (or Windows for Pens, for short). Manufacturers of pen computers (e.g., NCR, Grid, and Samsung) and pen applications (e.g., Slate) see merit in both approaches and are trying to support both PenPoint and Windows for Pens.

You can test-drive Windows for Pens using nothing more than an ordinary desktop or notebook system and a mouse. For real development work, however, you'll need at least a digitizing tablet—preferably one with an integrated display—or, better yet, a stand-alone pen machine like the NCR 3125.

Installing the pen extensions barely disturbs a preexisting Windows 3.1 setup. New mouse and display drivers appear in SYSTEM.INI, a set of pen-related tools show up on the Control Panel, and an application called PenPalette lands in the start-up folder. In the SYSTEM directory alongside the multimedia extensions, you'll find new DLLs that empower Windows to rec-



ognize handwriting and gestures. There's also a pen driver that acts as traffic cop, routing pen data to Windows as mouse events or to the pen subsystem as strokes, depending on context.

Thanks to PenPalette, unmodified Windows 3.x applications can make immediate use of the pen. You can write directly in dialog boxes and in pen-oblivious text editors like the SDK's EditFile (see screen 1). How? PenPalette watches for any window that creates an Edit control—more specifically, an Edit control that uses the standard I-beam cursor. PenPalette then converts the Edit control into a HEdit (for "handwriting edit") control, preempts its input, sends pen strokes to the recognizer, gathers up the resulting characters, and pumps them into the window as keystroke events.

The same mechanism supports gestures, which come in two flavors. *Core gestures* (see screen 2) invoke basic operations, like Copy, Cut, and Paste. An especially powerful core gesture is Delete Words, a back-and-forth stroke that simultaneously defines

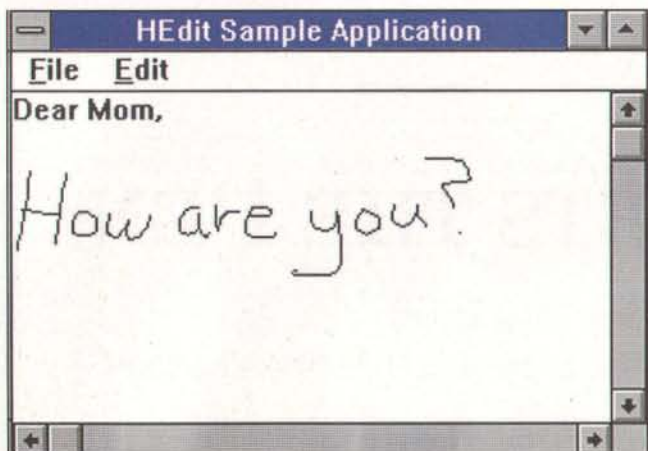

Screen 1: *The PenPalette application converts the Edit control into an HEdit control, routes pen input through the handwriting recognizer, and feeds keystrokes into pen-oblivious applications.*

and cuts. Also available are *circle gestures*, which you draw by encircling letters of the alphabet. These are systemwide or application-specific macros that expand into user-defined sequences of keystrokes.

You Train It; It Trains You

Recognition improves dramatically during your first few hours of interaction with the system. An introductory tutorial on gestures helps get you started. It demonstrates the gestures, invites you to reproduce them, and offers useful feedback, such as "Your gesture was too far to the right." Once you begin writing in earnest, training becomes an intricate duet—you train the system, and it trains you. Any

time the recognizer errs, you can launch the Trainer.

Screen 3 illustrates two kinds of errors that you can use the Trainer to correct. The first *r* in *Margaret* was not recognized at all; the second *a* was misrecognized as *u*. In both cases, you can tell the Trainer to assign the meanings you intended—but should you? In this case, I'd approve the *r* but not the *a*; the latter is just too sloppy. To call that shape an *a* would invite confusion with *u*. Here, I'd allow the Trainer

to train me to write *a* more carefully.

The Trainer can access the database of character forms by meaning (i.e., character or gesture) or by shape. In screen 4, I used the meaning *g* as the search key and reviewed the set of shapes mapped to that character. In screen 5, I used a *g* shape as a search key and retrieved the set of similar shapes. Some of these meant *g*, and others meant *y*; the difference hinges on the degree of openness or closure. I fine-tuned the discrimination between the two by drawing shapes that tested the boundary conditions and adjusting meanings until I was satisfied.

If you inadvertently assign multiple meanings to a shape (see screen 6), you'll want to resolve the ambiguity. In this case, I decided to preserve the meaning *S* and adjusted its size accordingly (see screen 7). Note the cursive appearance of some of the *s* samples in screen 6. Although the recognizer does not support connected cursive handwriting, it handled broken cursive very nicely once I trained it to do so. You can also train the system to recognize pairs or triplets of characters (see screen 8).

The system remembers all your training in a file that you can move to another Windows for Pens machine. In addition, it

BYTE ACTION SUMMARY

The first generation of pen-enabled computers will find markets very different from those today's desktop systems serve. Utility-meter readers, traveling salespeople, and other mobile information workers are the targets of the initial wave of pen-centric applications. It wouldn't be surprising, though, if pen awareness starts infiltrating the mainstream world of desktop and notebook computing. The ability to define and execute in a single gesture is particularly compelling.

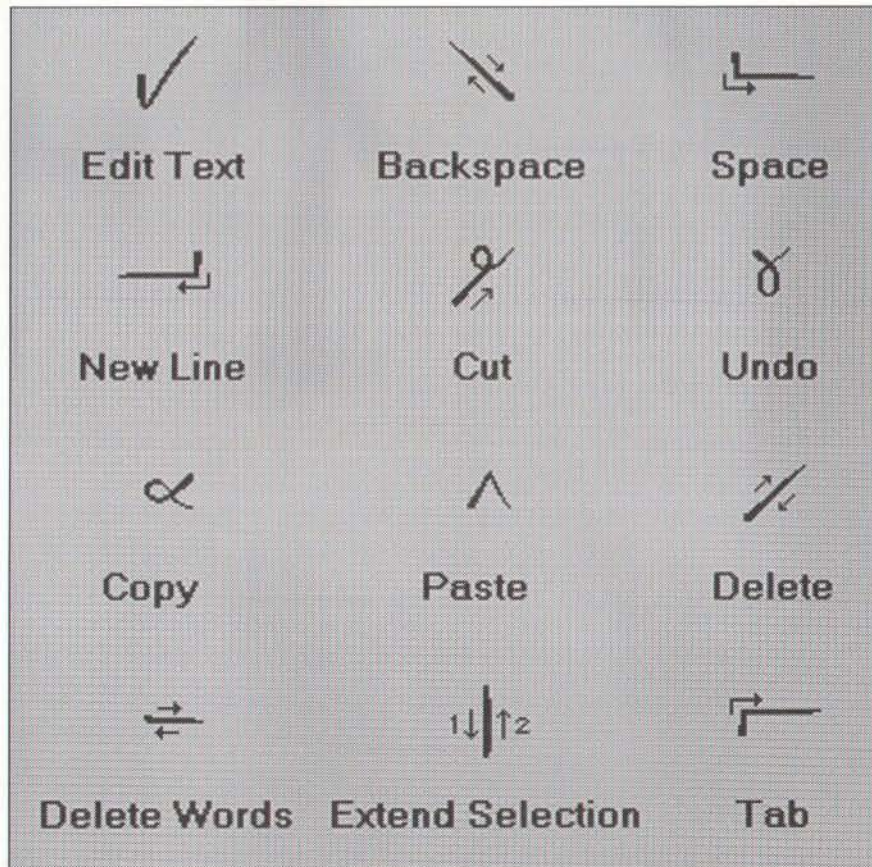

Screen 2: *The immediacy of gestural commands like Copy and Paste is striking.*

Borland
Sets the Standard

Unleash the power of the C with Borland C++

Professional C programmers are choosing object-oriented C++ because they know it increases productivity. And the C++ they're choosing is from Borland. Borland® C++ & Application Frameworks gives you amazing code reusability, extensibility and easier

maintenance. With more than 650,000 copies of Borland's C++ products in use, Borland C++ sets the standard.

C and C++ for DOS and Windows

Borland C++ & Application Frameworks is the #1 choice of professional C and C++ programmers for Windows and DOS application development. The third-generation C++ compiler fully supports the AT&T CFRONT 3.0 standard C++, including templates! The powerful C compiler fully implements the

**INFO
WORLD
PRODUCT
OF THE
YEAR**

1 9 9 1

ANSI C standard. And the Application Frameworks dramatically reduce your development time with sleek user interfaces and high-level objects that bolt right on to your application with just a few lines of code.

The C++ you can rely on!

Borland C++ & Application Frameworks includes:

- ObjectWindows™ for Windows
- Turbo Vision™ for DOS
- Complete source code for both Application Frameworks and the runtime library
- Borland C++ 3.0

Borland C++ 3.0 includes:

- Full C++ with templates
- ANSI C
- Global optimizer

- Precompiled headers
- Windows Development Environment
- DPMI support
- ObjectBrowser™ visually displays classes
- EasyWin™ converts DOS apps to Windows
- Resource Workshop to create Windows dialogs, menus, bitmaps, icons and more
- WinSight™ message tracking utility
- Turbo Debugger® for DOS and Windows
- Turbo Profiler™ for DOS and Windows
- Object-Oriented Turbo Assembler®

Borland makes your transition from C to C++ easy!

Borland has created two video training packages, complete with workbook and sample source code that you can plug right in to your program. And now with your order, you can get one *FREE* (retail value \$99.95). If you buy Borland C++ (\$495 suggested retail price*), you'll receive the *World of C++* video training package *absolutely free*. If you buy Borland C++ & Application Frameworks (\$749 suggested retail price*), you'll get *World of ObjectWindows for C++ FREE*.

Free C++
video
training
offer

See your dealer today or call now,
1-800-331-0877, ext. 5352

ACT NOW! WHILE SUPPLIES LAST



B O R L A N D
The Leader in Object-Oriented Programming

*All prices are in U.S. dollars. Dealer prices may vary. Offer good in U.S. and Canada only. Copyright © 1992 Borland International, Inc. All rights reserved. All Borland products are trademarks of Borland International, Inc. BI 1480

Circle 12 on Inquiry Card (RESELLERS: 13).

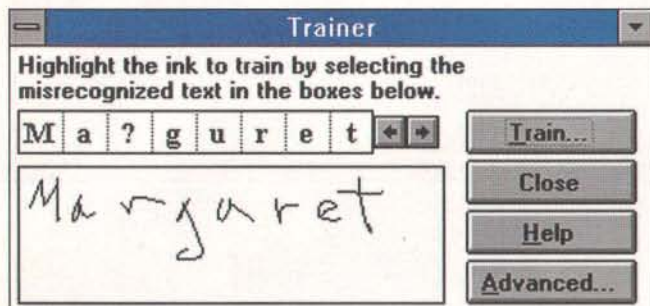

Screen 3: You can tell the Trainer that you meant the second *a* as a *u*, but is that fair?

Screen 4: The database stores a variety of samples of my *g*. The Trainer can access a database of character forms by meaning (i.e., character or gesture) or by shape.

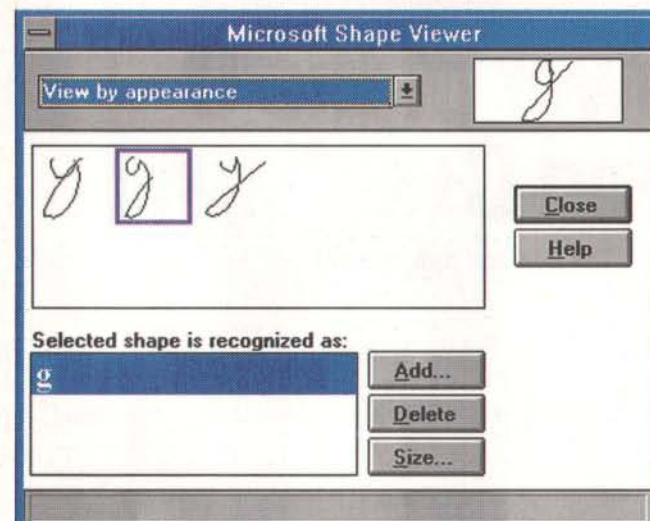
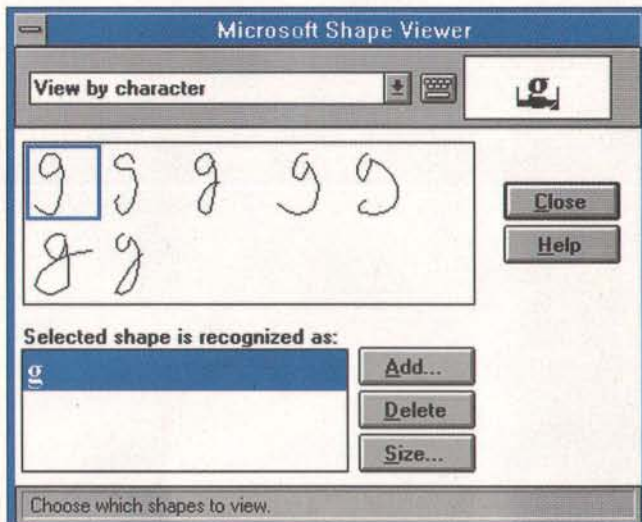

Screen 5: The shapes that match the search key can have different meanings. Here, the other two shapes mean *y*.

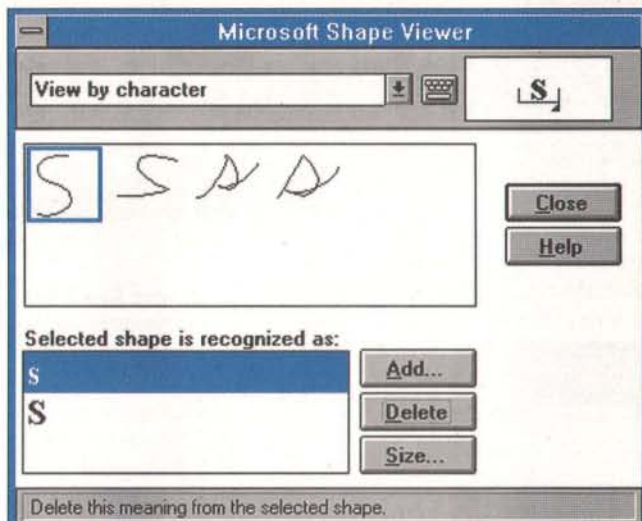

Screen 6: If a shape acquires multiple meanings, you'll need to remove the ambiguity.

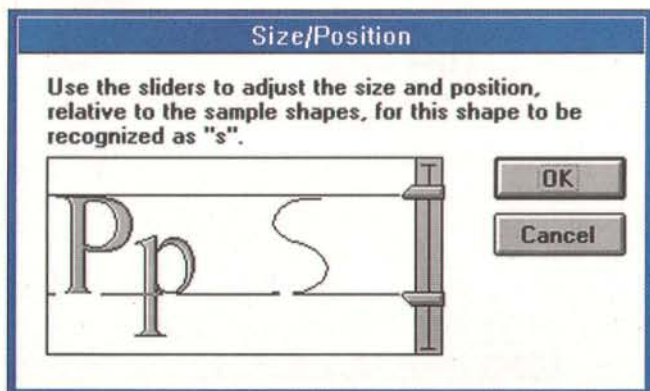

Screen 7: Specifying a shape's size and its position relative to a baseline helps resolve ambiguity.

Screen 8: Training the system to accept pairs or triplets of characters allows for a bit of connected cursive writing.

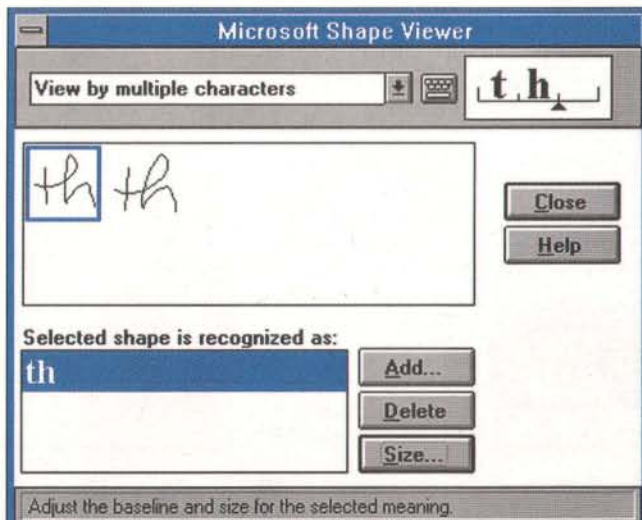

continued

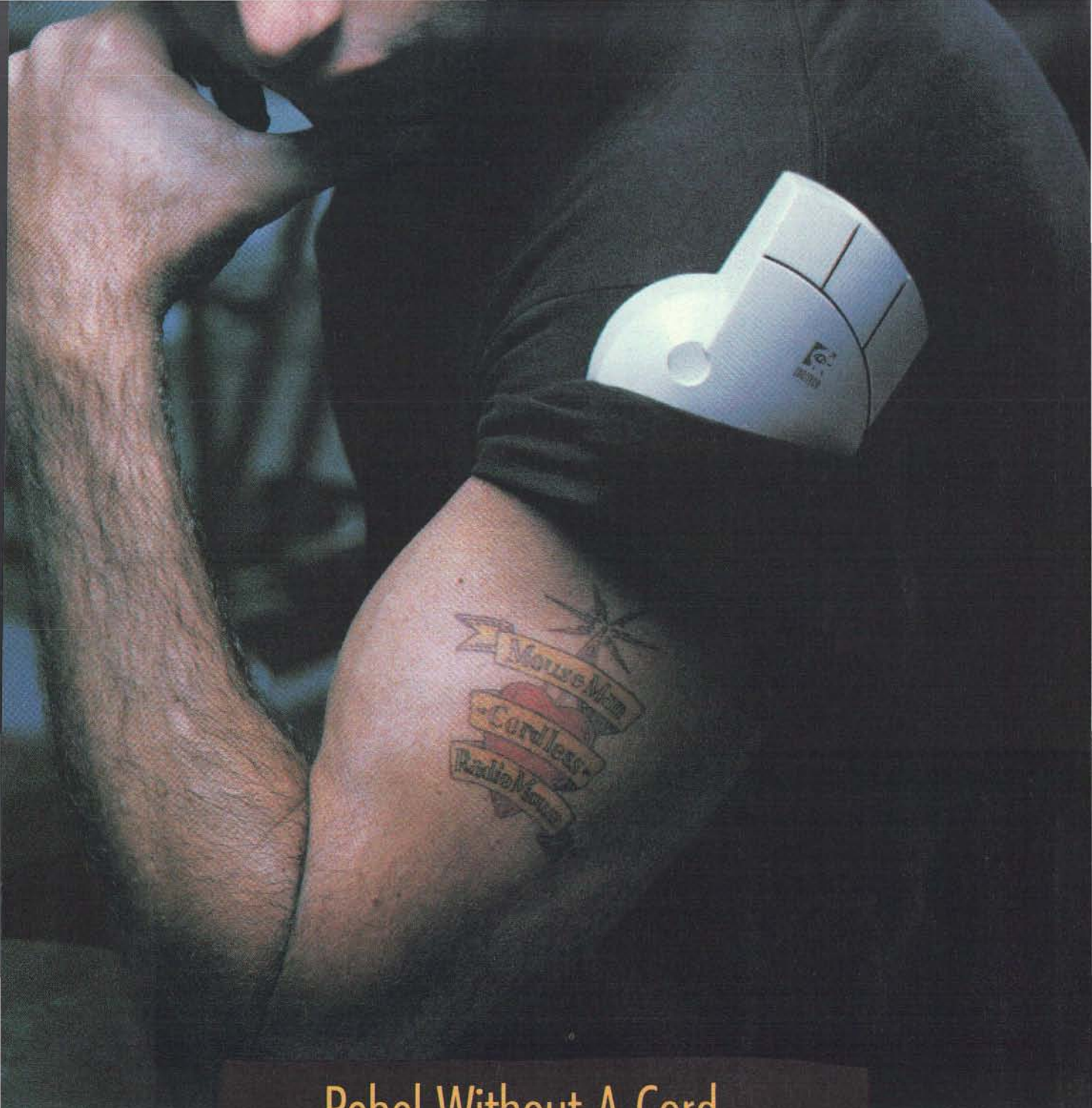

Rebel Without A Cord

MouseMan® Cordless Radio Mouse—nothing stands in its way, or ties it down. Unique radio technology controls your cursor from up to six feet away, no matter what's on your desktop. Battery lasts up to a year. Sure beats wimpy infrared mice—those signals get fouled up by any little thing and suck batteries dry in a few hours.



MouseMan Cordless also *feels* awesome: unique ergonomics; adjustable resolution; 100% compatibility; programmable Windows™-crunching buttons. All for about the same as most corded mice, complete with money-back satisfaction guarantee.

1-800-231-7717, ext. 347.

®/™—these trademarks are the property of their registered owners. GSA approved.

Circle 123 on Inquiry Card (RESELLERS: 124).

Announcing the

BYTE EURODECK

The First Computer Postcard Deck Targeting the Exploding European Market!!!

By the end of 1992, the European Community will be a \$14 trillion market. In fact, behind the US, it's the largest microcomputer market in the world!

If you are a BYTE subscriber in Europe, watch for the new EURODECK coming to you soon! The BYTE EURODECK contains a selection of state-of-the-art products important to you and your business.

Advertisers!

The BYTE EURODECK offers you a unique direct mail approach to increasing sales in this fast-paced computer market.

Circulation of the BYTE Eurodeck is targeted to 50,000 computer buyers in over 20 countries in Western Europe. Take full advantage of the benefits of the upcoming unification of Europe in 1992! For information on the next BYTE EURODECK, call Jim Bail today at **603-924-2533!**

Companies outside of North America, please contact your local representative.

WINDOWS/WINDOWS MEETS THE PEN

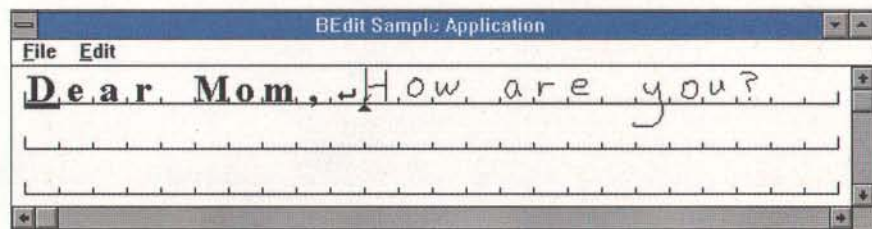

Screen 9: Writing in the boxes feels awkward but improves recognition.

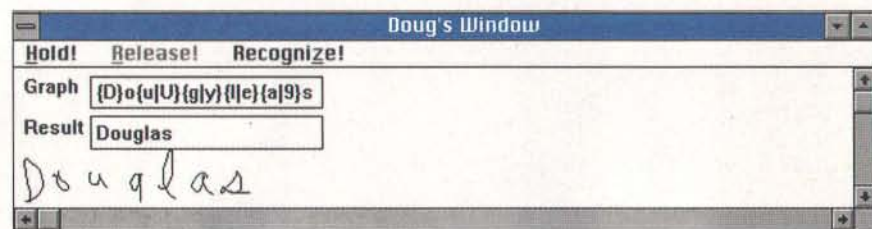

Screen 10: The symbol graph that the recognizer produces often includes alternative interpretations for characters. Dictionaries help the system arrive at a final result.

maintains a list of users and their preferences. From the Control Panel, you can tell my machine to load your training database. If you're left-handed, you'll also want menus to drop to the right rather than the left so that your writing hand, resting on the display, won't obscure them.

Pen Awareness

An unmodified application receives handwriting and gesture support only when PenPalette is active. By registering itself with the pen subsystem, an application frees itself from this dependence. Minimally, that involves testing for the presence of the pen subsystem and then calling RegisterPenApp. The application's Edit controls become HEdit controls that handle recognition. This looks like the same result you get with PenPalette, but the behavior differs in a subtle and interesting way.

Consider the EditFile application in the Windows 3.1 SDK. Using PenPalette's support, the program reacts to the Copy gesture with the message "Command not implemented." That's because PenPalette converts the gesture into an accelerator key, Control-Insert, which the application sees as a menu selection, IDM_COPY, that it does not implement in this case. When I registered the application with the pen subsystem, however, gestures like Copy and Paste simply worked.

These behaviors come "for free" with pen awareness, and they are immediate, requiring no interaction with the menu system. While you generally have to add code to achieve pen awareness, it's interesting to note that that's not always so.

An application that is minimally pen-

aware is also, not surprisingly, minimally useful in the absence of a keyboard. Applications that target pen-only machines need to be truly pen-centric, and that means cracking open the Windows for Pens API.

Since handwriting recognition isn't perfect, pen-centric applications strive to optimize the use of the pen. One option is to use BEdit (for "boxed edit"; see screen 9) rather than HEdit controls. Writing in the character boxes is about as much fun as filling out a credit-card application, but it does enhance recognition.

In many cases, it's useful to constrain the allowable inputs to HEdit or BEdit controls—a feat that entails manipulating Windows for Pens' central data structure, the RC (recognition context). One of the slots in an RC specifies sets of allowable characters, or ALCs (alphabet codes). Here is how you'd set a field to recognize only uppercase letters, digits, or gestures:

```
RC rc;
rc.alc = ALC_UCALPHA |
        ALC_NUMERIC | ALC_GESTURE
```

The special constant ALC_USEBITMAP instructs the recognizer to scan a 32-byte-long bit field that maps the 256 ANSI characters. Only the characters corresponding to the bits that you've set will be recognized.

Dictionaries

The recognizer's raw output isn't simply a string of characters, but rather a *symbol graph* (see screen 10) that can encode several alternative meanings for each input shape. The system refers to a *dictionary* to help select the likeliest interpretation.

continued

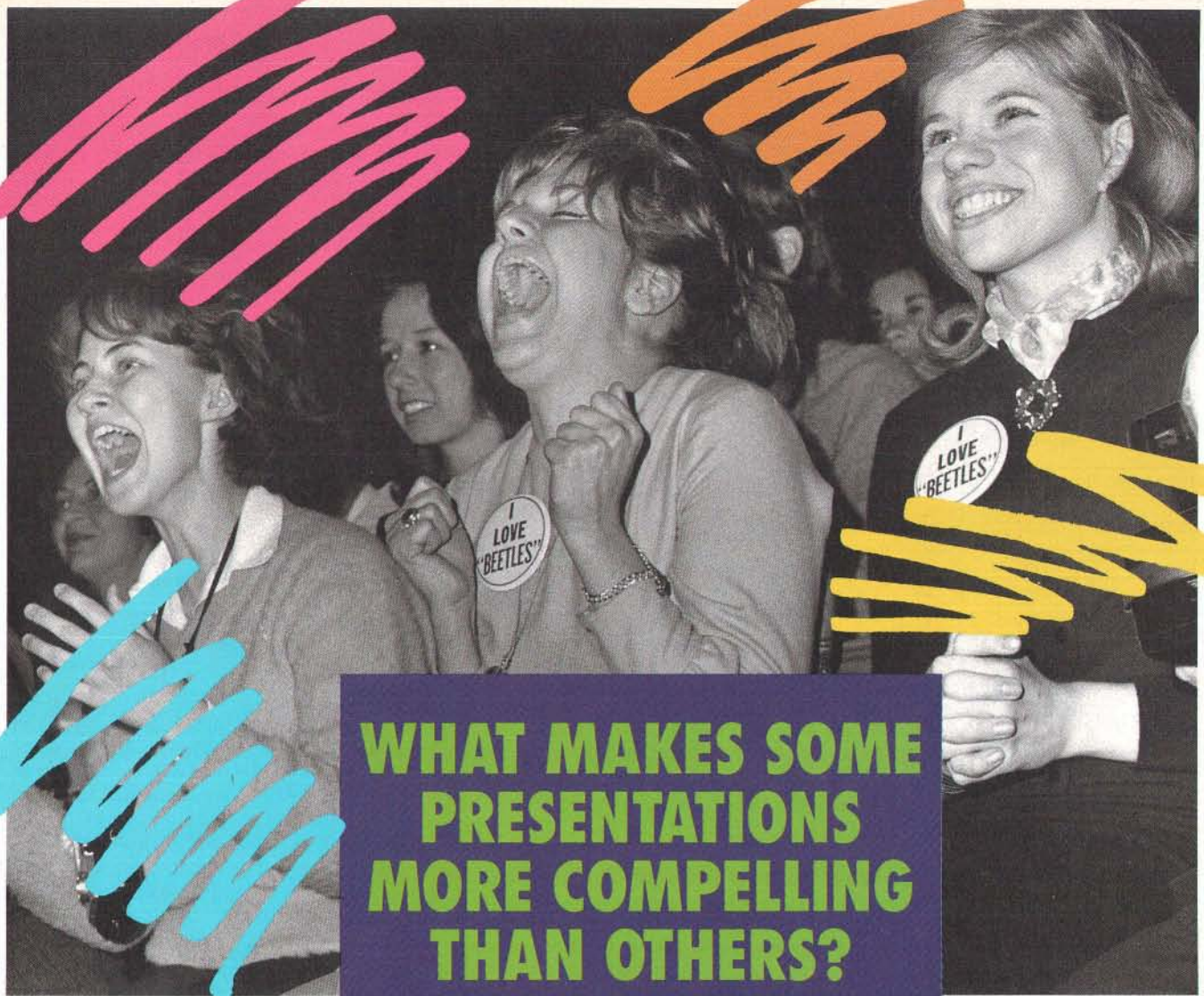

WHAT MAKES SOME PRESENTATIONS MORE COMPELLING THAN OTHERS?

CAPTIVATING PRESENTATIONS ARE EASY WITH DECPRESENT FOR SUN SPARCSTATIONS.

Now your presentations can really excite your audience. All you need to turn your great ideas into compelling visuals is your Sun® SPARCstation™ and DECpresent™ software.

With DECpresent, you can build clear and attractive slides from a simple outline in minutes, mix and match slides from other presentations, and even link your slides to live data on the network. The sorter view displays your entire presentation on the screen, and speaker notes ensure that you'll make the most convincing points. You'll create presentations that look like they took hours to prepare in just a few short minutes.

Call your favorite reseller listed below for our demonstration disk and see how DECpresent can make you a star.

digital™

SPECIAL OFFER—\$795 per user until June 27, 1992.

Qualix Group
1-800-245-8649

UNIX Central
1-800-553-8649

DUX Software
1-800-543-4999

DIGITAL. THE OPEN ADVANTAGE.

1	Exxon
2	General Motors
3	Mobil
4	Ford Motor
5	IBM
6	Texaco
7	E.I. du Pont
8	Standard Oil (Ind.)
9	Standard Oil of Cal.
10	General Electric
11	Gulf Oil
12	Atlantic Richfield
13	Shell Oil
14	Occidental Petroleum
15	U.S. Steel
16	Phillips Petroleum
17	Sun
18	United Technologies
19	Tenneco
20	ITT
21	Chrysler
22	Procter & Gamble
23	R.J. Reynolds Ind.
24	Getty Oil

25	Standard Oil (Ohio)
26	AT&T Technologies
27	Boeing
28	Dow Chemical
29	Allied
30	Eastman Kodak
31	Unocal
32	Goodyear
33	Dart & Kraft
34	Westinghouse Elec.
35	Philip Morris
36	Beatrice Foods
37	Union Carbide
38	Xerox
39	Amerada Hess
40	Union Pacific
41	General Foods
42	McDonnell Douglas
43	Rockwell Int.
44	PepsiCo
45	Ashland Oil
46	General Dynamics
47	3M
48	Coca-Cola

49	Consolidated Foods
50	Lockheed
51	Georgia-Pacific
52	Monsanto
53	W.R. Grace
54	Signal Companies
55	Anheuser-Busch
56	Nabisco Brands
57	Johnson & Johnson
58	Coastal
59	Raytheon
60	Honeywell
61	Charter
62	General Mills
63	TRW
64	Caterpillar Tractor
65	Aluminum Co. of Amer.
66	Sperry
67	Gulf & Western Ind.
68	Continental Group
69	Bethlehem Steel
70	Weyerhaeuser
71	Ralston Purina
72	Colgate-Palmolive

WINDOWS

A dictionary is a DLL that exports the standard entry point `DictionaryProc` and responds to some or all of a set of standard requests.

Windows for Pens ships with two dictionaries. The main dictionary, always consulted unless an application specifies otherwise, uses a standard English lexicon (Soft-Art's spelling checker) to help in-

The pen makes
a better mouse
in some ways.

terpret symbol graphs. Applications can also enlist the help of the user dictionary, which compares symbol graphs to lists of words contained in plain ASCII text files.

Both of these dictionaries operate conservatively; they don't force interpretations to match dictionary entries. However, it's possible and often useful to build a custom dictionary that completes partial input. The Windows for Pens SDK includes a sample expense-form application that works this way. As soon as the recognizer returns an *H* in an expense-item field, the custom dictionary completes the word *Hotel*.

To enable the user dictionary or a custom dictionary in a given recognition context, you fill an RC slot with a pointer to its `DictionaryProc`. To configure it, you call the `DictionaryProc` with requests like `DIRQ_OPEN` (open a word list), `DIRQ_SETWORDLISTS` (set the current word list), or `DIRQ_ADD` (add a word to a word list). To enable completion, you specify the RC option `RCO_SUGGEST`, which in turn invokes the dictionary's `DIRQ_SUGGEST` method.

Although dictionaries condition the interpretation of a symbol graph, applications can always override that interpretation by inspecting the symbol graph directly. It's a bit more work, though. Instead of relying on the automatic recognition that the `HEdit` and `BEdit` controls provide, the application must call the recognizer directly.

One approach is to call `IsPenEvent` on receipt of a `WM_LBUTTONDOWN` message (i.e., a left-button mouse-click). If this function returns true, the user has started to write. The application initializes an

27 million Americans can't read. And guess who pays the price.

While American business is trying to stay competitive with foreign companies, it's paying an added penalty. The penalty of double-digit illiteracy.

Believe it or not, 27 million American adults can't read and write. Another 47 million are literate on only the most minimal level. That adds up to almost one third of our entire population... and probably a disturbing number of your employees.

What does illiteracy cost you? Get out your calculator. Illiterate adults make up 50%-75% of our unemployed. Every year they cost us an estimated \$237 billion in lost earnings. They swell our welfare costs by \$6 billion annually and diminish our tax revenues by \$8 billion.

Illiteracy costs you through your community, too. It robs the place where you work and live of its resources. It undermines the potential of the people who make your products and the people who buy them. No dollar figure can be assigned to this. But over the years, this may be the costliest loss of all.

What can your company do about this? It can join in local efforts to fight illiteracy. It can volunteer company dollars and facilities for better school and tutorial programs. It can invest in a more literate community.

The first step is to call the Coalition for Literacy at **1-800-228-8813** or fill out the coupon below. Do it today. You may find it's the greatest cost-saving measure your company has ever taken.

**A literate
America
is a good
investment.**



Coalition for Literacy

- I want my company to join the fight against illiteracy. Please send brochure with additional information.
- We want to discuss funding the Coalition for Literacy. Please have a representative contact me.

Name _____
 Title _____
 Company _____
 Address _____
 City _____ State _____ Zip _____
 Phone _____

Please return to: Coalition for Literacy
 Business Division
 PO Box 81826
 Lincoln, NE 68501-1826

This Approach Eliminates All Barriers To Databases.



"Approach for Windows is an amazing product with features galore... No other Windows database to date is as powerful or easy to use... You'll be as wowed by it as we were," says PC Computing.

this. Fittingly, it's called Approach™ for Windows™—a remarkable new Windows database. The first truly approachable one. And the only one that's both a stand-alone database—with its own relational engine—and a front-end to other data.

Approach is so easy anyone can use it. It takes just minutes to build a new database or produce a professional report. You'd expect that from a database with this much speed. One that includes a tightly integrated, built-in forms design package with extensive graphics tools, a slew of turnkey business templates, and a report generator.



We've bottled all the graphics and layout tools you'll need. So even a first-time user can produce professional reports in minutes.

Circle 311 on Inquiry Card.

For many of us, running a database is like running an obstacle course. If it has any relational power at all, you'll get snagged on programming. If you want to share information with other databases, you'll hit a wall. And, of course, there's the hurdle of using a database over a network.

Now someone's figured out a way around all

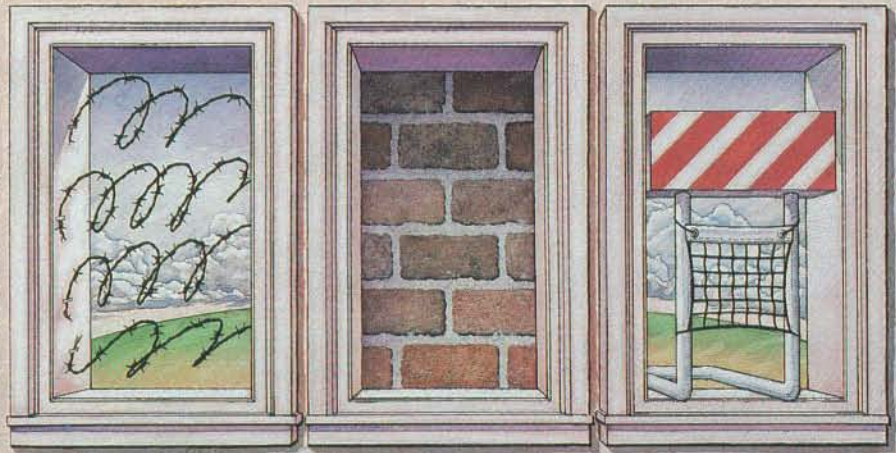

Break through the barriers of Windows databases. "Approach proves you can deliver a high performance relational database anyone can use," lauds Technical Director J. Diamond of the Windows User Group.

power. Even the power to link up to 10 databases simultaneously.

Something else you can harness is existing data. Approach is built for superb client/server performance from the ground up. Using our exclusive PowerKey™ technology, you get something previously unheard of: 100% compatibility with dBase®, Paradox®, or Oracle® SQL data.



Since Approach is also 100% network compatible (no set-up required), you can access, manipulate, mix, update, and report on information while others work on the same file, in either Approach or the native application.

So call us at 1-800-Approach or see your local dealer. Because if you want the database path of least resistance, there's only one Approach.

I'D CALL MY DEALER OR 1-800-APPROACH



APPROACH SOFTWARE CORPORATION

© 1992, Approach Software Corporation, 311 Penobscot Drive, Redwood City, CA 94063. Approach and PowerKey are trademarks of Approach Software Corporation. Windows is a trademark of Microsoft Corp. All other trademarks are properties of their respective companies.

RC and calls Recognize. When the recognizer finishes, it sends a WM_RCRE-SULT message, which carries a pointer to an RCRESULT structure that contains the recognized characters, the symbol graph, and the corresponding ink.

Working with Ink

If you're taking notes rapidly and don't have time to correct your writing, you might want to defer recognition until a more convenient time. And of course, if

you are signing your name, you don't want recognition to occur at all. Raw pen strokes that you can store, copy, or replay—a special data type called *ink*—play a critical role in pen computing.

Consider the notepad next to your telephone. Its pages say more than the alphanumeric characters you've written there; diagrams, arrows, and other visual cues subtly enhance the information content. Emerging pen-centric applications support these kinds of annotations by enabling the

collection and manipulation of ink.

To defer recognition in a HEdit or BEdit control, you need only send its window the HE_SETINKMODE message. The complementary message HE_STOPINKMODE activates recognition again. At a lower level, you can use the ink handle included in an RCRESULT structure to duplicate, redisplay, resize, or enumerate a set of pen strokes.

Alternative Recognizers

Recognizers are replaceable components in Windows for Pens. Since the default recognizer is a DLL, you can just replace it with another DLL that conforms to the standard protocols for collecting pen data, forming a symbol graph, utilizing dictionaries, and responding to training requests. Nestor's NestorWriter is one example of an alternative recognizer now being licensed to manufacturers of pen-based systems. (It can also replace PenPoint's recognizer.)

While developers of pen applications aren't going to build full-blown handwriting recognizers, they're likely to create auxiliary recognizers that handle application-specific shapes. For example, Windows for Pens comes with a shape recognizer applications can use to convert wobbly hand-drawn lines, ellipses, and rectangles into clean GDI (Graphics Device Interface)-rendered lines, ellipses, and rectangles. The pen SDK also has a skeleton for building a special-purpose recognizer.

The Power of the Pen

The first generation of pen-enabled computers—at least 15 companies say they'll have units for sale by this fall—will find markets very different from those today's desktop systems serve. Utility-meter readers, traveling salespeople, and other mobile information workers are the targets of the initial wave of pen-centric applications. Clearly, Windows for Pens deserves its fair share of that market. The pen extensions exhibit a clean, modular design and benefit greatly from the existing base of experience with Windows programming.

I wouldn't be surprised, though, if pen awareness starts infiltrating the mainstream world of desktop and notebook computing. I hope I'll never again have to write 2000 words by hand—either on paper or on a pen computer. But the pen does make a better mouse in some ways. The ability to define and execute in a single gesture is particularly compelling. Mainstream Windows programs could learn some useful tricks from their pen-centric cousins. ■

Jon Udell is a BYTE senior technical editor at large. You can reach him on BIX as "judell."

Move to Windows, stay with the VAX.™

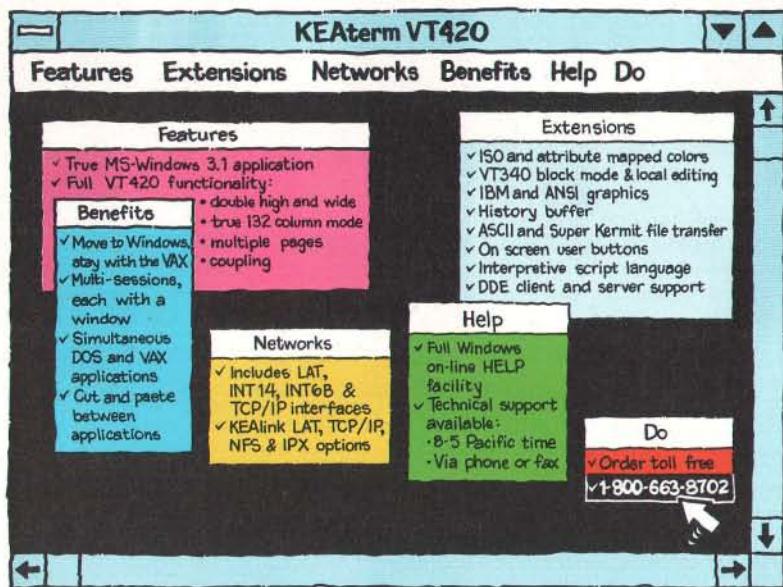

VT emulation under Windows

KEA has VT emulation and connectivity products for your PC: KEAterm VT emulation for MS-Windows; ZSTEM VT emulation for MS-DOS and SCO UNIX; the PowerStation VT layout keyboard for your PC; and KEALink network products for connecting to your VAX or UNIX host.

Tel: (604)431-0727 Fax: (604)431-0818
Orders: 1-800-663-8702



KEA Systems Ltd., 3738 North Fraser Way, Unit 101, Burnaby, BC, Canada V5J 5G1
Copyright © KEA SYSTEMS LTD. 1992. All rights reserved. KEAterm, KEALink, PowerStation, ZSTEM and the KEA logo are trademarks of KEA Systems Ltd.
All other brand and product names are trademarks or registered trademarks of their respective holders.

PROCOMM PLUS for Windows

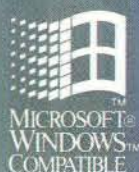
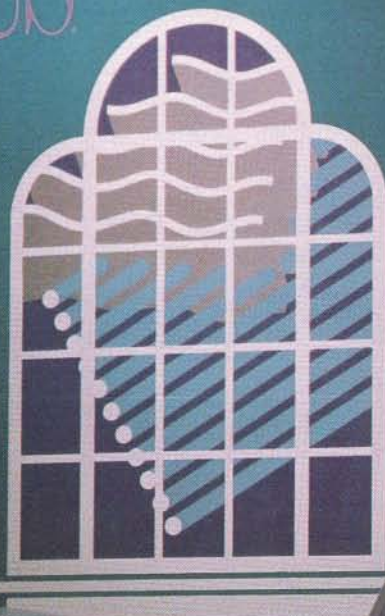

The Streak Continues!

Introducing the Windows version of
the best-selling communications software in the world.

PROCOMM PLUS has opened the eyes of the world to a superior communications package. Now, people with their sights set on communicating with Windows have a choice just as clear. PROCOMM PLUS for Windows. The power and ease of use of PROCOMM PLUS combined with the

elegance of Windows. Look for it now at your software dealer. If you currently own PROCOMM PLUS, upgrade to PROCOMM PLUS for Windows for just \$69.00 by calling 1.800.326.4999. And discover for yourself why PROCOMM PLUS for Windows leaves the competition in the fog.

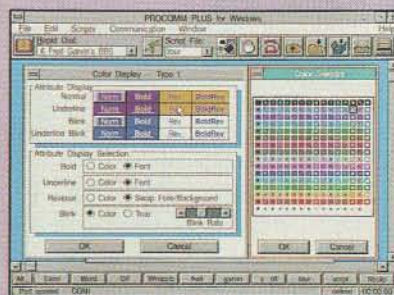

DATASTORM
DATASTORM TECHNOLOGIES, INC.

P.O. Box 1471 • Columbia, MO 65205 • 314.443.3282

Circle 24 on Inquiry Card.

WHICH IS THE BEST FOR YOUR WORK.

New Time Line for Windows. Because using your project management software shouldn't be a project in itself.

If the project management software that you've tried has been long on promises and just short of impossible to use, you haven't seen Time Line® for

**TIME
LINE**
FOR WINDOWS

Once again, Symantec sets the standard for project management.

Windows. An entirely new version of Time Line, the industry standard, designed from the ground up to be easy to learn, responsive to your needs, and extremely powerful.

So usable, you'll actually use it.

If you can work a spreadsheet,

Windows. An entirely new version of Time Line, the industry standard, designed from the

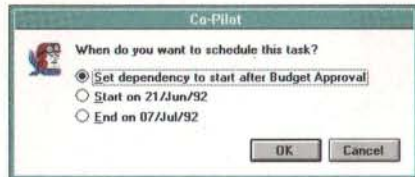

Co-Pilot, our unique on-board consultant, takes the guesswork out of your project.

structure an outline, and use a mouse, you can be up and printing your first reports in less than an hour. A true graphical Windows application, you simply point, click, and drag to re-arrange elements in your schedule. Use the Connect Tool to set task and resource relationships by drawing a line. And import files from Time Line DOS, On Target,™ and Microsoft Project for Windows.

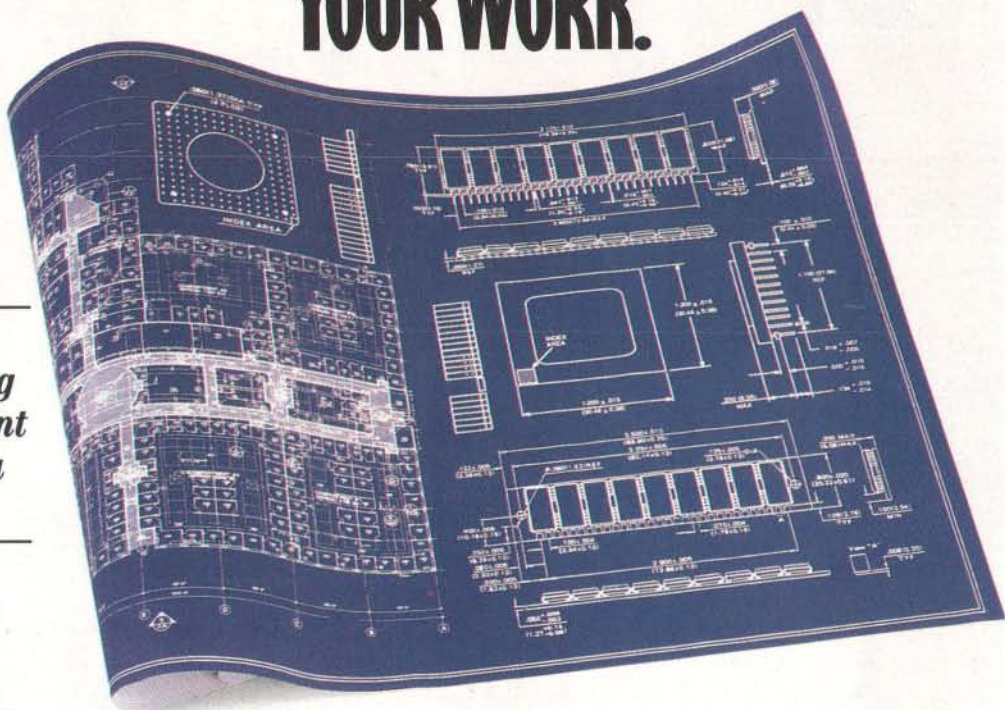

Once you've started planning, you won't go it alone. Co-Pilot,™ our exclusive on-board logic, uses plain English to prompt you through the process of building your schedule.



To stretch tasks, re-prioritize activities, or even set dependencies, simply point and click on the Icon Bar.

**Real power
made easy.**

Time Line became the industry standard for its unmatched set of powerful, yet easily accessible

BIGGER PROJECT!

YOUR PROJECT MANAGEMENT SOFTWARE.



*New for
Windows 3.1!*

tools. That includes Symantec innovations such as true effort-driven scheduling; as well as resource leveling, individual resource calendars, priority scheduling, OLE, and schedule consolidation.



Flexible reporting options, such as Calendar Report, make it easy to get what you need in the format you need it in.

Professional reports, the first time out.

Clear, concise reporting is critical to getting your projects approved and keeping them on track. Time Line for Windows

excels at producing crisp, colorful, and persuasive documents.

Features like Autoscale optimize printing—even force documents to one page, making it easy to turn out professional-quality presentations and status reports.

So you see, project management software doesn't have to be

such a project. With Time Line for Windows you can quickly take control of your workload. With a lot less work. If your current software isn't working for you, call **1-800-228-4122, ext. 328-Y** for more information or a demo disk. Or see your local dealer.

Ask about our competitive upgrade—just \$199* (a \$699 value).

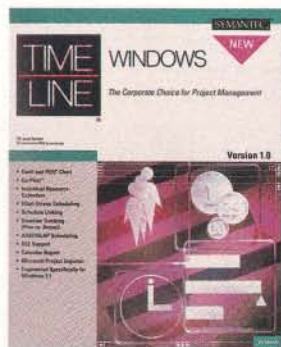

SYMANTEC.

FLYING WINDOWS

Ten accelerator adapters offer the least expensive route to date for transforming Windows into a blisteringly fast and productive environment

If you're like me, your daily computing needs alternate between DOS and Windows applications. When time is of the essence, you still rush to your DOS applications, such as WordPerfect and Lotus 1-2-3, to compose documents or to compute spreadsheet data. But when you have more time, Windows has an appeal that's hard to resist.

Time, then, is the driving force behind your choice, and products that improve the time restraints of Windows are of great interest. Recently, I examined 10 speed-enhancement adapters that can transform the tediously slow Windows desktop into a blisteringly fast and productive environment.

Moving Right Along

In some instances, it actually felt as if my 486/25 system had accelerated to 150 MHz. For a relatively small investment (\$299 to \$995), these accelerator adapters offer the least expensive route to date for enhancing PC speed and Windows productivity (see the text box "Speeding Windows" on page 174).

Accelerating Windows applications with alternative display-adapter hardware is not a new concept (see "Tweaking Windows: New Adapters Boost Speed and Clarity" in the January BYTE). However, with so many enhancement adapters entering the marketplace, as well as emerging Super VGA display resolutions above 1024 by 768 pixels, BYTE wanted to take another look at them.

My goals were to reexamine objectively the claims of Windows display accelerator vendors and to provide a subjective critique of the installation process and documentation quality. Because of the number of boards I wanted to test and the deadline I was under, I placed prime importance on the ease with which I could reconfigure an existing Windows installation to include a speed-enhancement adapter.

The 10 accelerators I examined (see the table) all used 16-bit ISA bus slots and shipped with 1 MB of on-board VRAM (video RAM), except for the two 2-MB Hercules TIGA (Texas Instruments Graphics Architecture)-based boards. I tested all of them at varying resolutions and refresh rates. (The combination of graphics data and an ISA bus tends to create a bottleneck; one approach to overcoming it is outlined in the text box "Local Bus

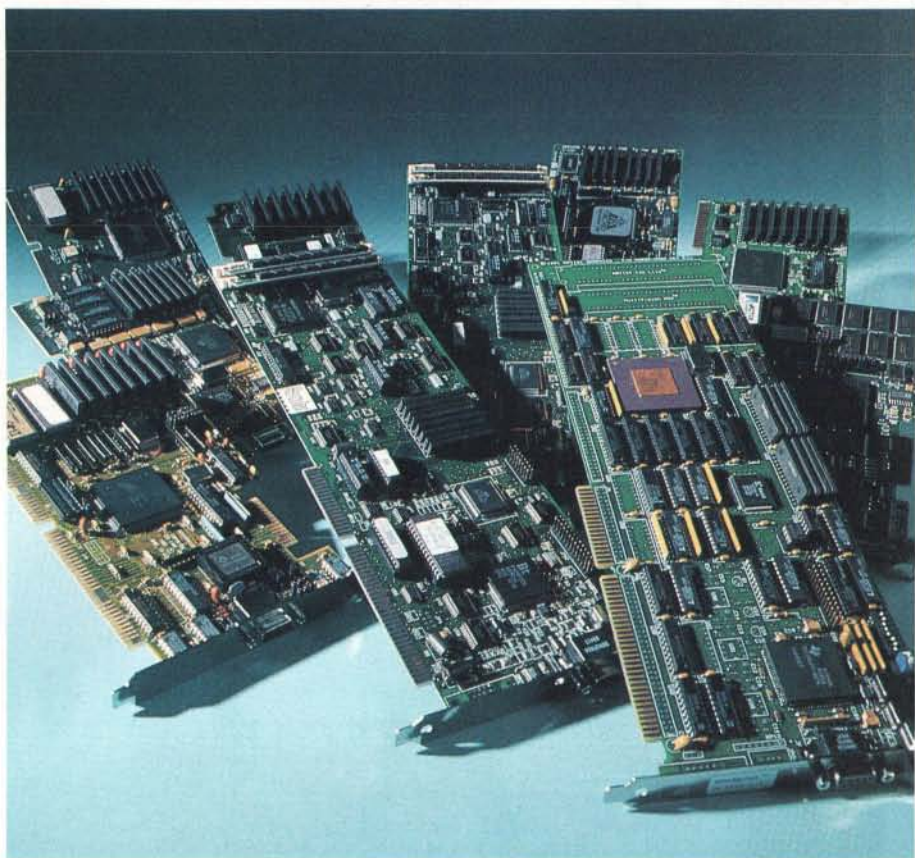

Video" on page 178.) I performed my objective Windows-applications and display-speed tests with Windows 3.0 at the 1024-by-768-pixel resolution with 8-bit color (i.e., 256 colors) in either interlaced or noninterlaced refresh rates, depending on the board's requirements (see figure 1).

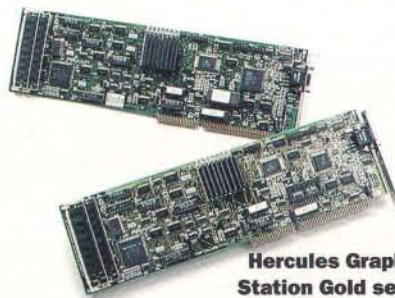

Hercules Graphics Station Gold series

Put a TIGA in Your Tank

The Hercules Graphics Station Gold series of full-length adapters, based on the TMS34010 TIGA coprocessor, ships in four configurations. The Gold 16 supports output

of 32,768 colors (the 1-MB version costs \$495; the 2-MB version, \$695), and the Gold 24 supports 16.7 million colors (1 MB for \$595, 2 MB for \$795). The adapters support Windows resolutions of up to 1024 by 768 pixels by 8 bits, and all four adapters ship with ImagePrep software and Autodesk product drivers. I tested a Gold 16+2 and a Gold 24+2, both 2-MB versions.

The Gold cards and their software are easy to install. Both of them connect to existing Super VGA adapters (in this instance, my 1-MB SpeedStar) via feature-bus connections that implement VGA pass-through. This allows a Super VGA adapter's VGA output to be routed through the Gold card; you then simply move your monitor's input cable to the 15-pin D-shell VGA out connector on the Gold card. The procedure is uncomplicated and thoroughly explained in Hercules's excellent documentation. Next, you install the TIGA communications software and then select the monitor-resolution mode.

From the Windows SETUP utility, you copy fonts and HERCULES.INI files from a Windows-driver floppy disk into the WINDOWS\SYSTEM subdirectory. With the Gold adapters, the display is beautifully crisp, clean, and sharp inside Windows at 1024- by 768-pixel resolution with 256 colors.

Compared to most S3-based adapters, however, the Gold cards fared badly in the WordPerfect arena but showed substantial speed gains with both PhotoStyler and CorelDraw. In some instances, they proved faster with these programs than some of the S3-based accelerators.

As an animator and imaging specialist, I liked these cards. Rather than viewing them as just Windows accelerators, I tested them at 16- and 24-bit color depths at 512- by 480-pixel resolution. Using the supplied drivers for 3D Studio, you can display full 16- and 24-bit color renders on standard VGA monitors. Also, Autodesk's Animator Pro and PixaArts' true-color image-manipulation program, Pixa-

Foto, functioned perfectly. If your Windows and imaging needs follow along these lines, the Hercules Gold adapters are an excellent value.



WinSprint 200

Artist Graphics' WinSprint 200 is a 1-MB full-length TMS34020-based TIGA coprocessor adapter that supports Windows resolutions of up to 1024 by 768 pixels in 16 or 256 colors. At \$995, the WinSprint 200 was the most expensive accelerator I looked at.

Like the Hercules boards, the WinSprint 200 uses VGA pass-through and TIGA communications software links. Board and software installation, however, are somewhat complex. On my Zeos EISA system, I had to reconfigure slots for memory and I/O base-address selection. (On ISA-based systems, this isn't necessary.)

The TIGA software installation is lengthy, and I had problems setting the environment variables. Artist Graphics' excellent technical support stepped me rapidly through both TIGA and Windows-driver installations. The WinSprint 200 documentation is good; the manual covers the associated settings; I had just overlooked them.

At a 1024- by 768-pixel resolution and 72-Hz refresh rate, both the Optiquest and Relisys 14-inch monitors' 65-MHz video bandwidths proved too small for the WinSprint 200's 75-MHz output clock. The board worked fine with Nanao's 20-inch FlexScan 9500 multifrequency monitor, which accepts video bandwidths of up to 120 MHz. Artist Graphics says that its boards soon will have video-bandwidth rates that work with all monitors.

The problems I experienced, however, proved well worth the effort required to overcome them. The WinSprint 200 makes

Windows fly, and in most tests, it considerably outpaced many S3-based cards. Within Windows, you can change virtual screen sizes to 2048 by 768 pixels or 1536 by 1024 pixels using WinSprint 200's 16-color Panorama utility. For wide Windows applications, like Excel spreadsheets, simply dragging the cursor left or right pans the display screen smoothly.

Although it costs almost twice as much as the other acceleration adapters, I was impressed with the WinSprint 200's crisp display, excellent Windows utilities, and sheer speed in most applications. The board will also ship with a scaled-down version of GT Express (a \$395 AutoCAD utility). If your Windows concerns are spreadsheet- and imaging-related, this board deserves your consideration.

continued

BYTE ACTION SUMMARY

■ **WHAT VIDEO-ACCELERATION CARDS DO**

They transform the tediously slow Windows desktop into a fast, productive environment.

■ **LIKES**

Clean, crisp displays, blinding speed, and (for animators and imaging specialists) TIGA's 16- and 24-bit color renders on standard VGA monitors.

■ **DISLIKES**

Complex installation and non-VBE compliance of some boards.

■ **RECOMMENDATIONS**

Its warp-drive speeds earn Diamond's Stealth VRAM card a rock-solid five-star rating and the overall recommendation as today's best buy in video-acceleration cards.

Gain speed in your problem solving and confidence in your answers with Maple V...

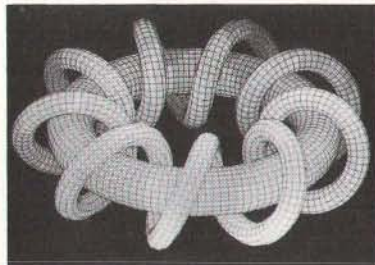

3-D Tube Plot created with Maple V.

The symbolic math software for engineering, science, and education professionals.

Maple, developed at the University of Waterloo, is today's most complete symbolic math package, and it's now available from MathSoft, the makers of Mathcad. Maple's comprehensive library of over 2,000 built-in functions and easy-to-use interactive environment delivers a maximum strength program in a surprisingly uncomplicated package.

• Provides power and flexibility.

You won't believe that something so powerful runs on everything from supercomputers to computers with as little as 1MB of memory. And Maple's flexibility makes it easy to share files across all platforms. It's completely programmable... and Maple's user interface supports natural mathematical calculations, so you can request an infinite variety of computations and graph your output in two or three dimensions.

• Use for a wide range of applications.

Maple is ideal for a wide range of applications, including helicopter blade design, VLSI design, chemistry, satellite guidance systems, econometrics, electrical engineering, and applied mathematics — to name just a few. Maple frees you from the "bookkeeping" of complex calculations and lets you concentrate on modeling and problem solving.

Call us toll-free at 800-628-4223 or use this coupon to request more information on Maple.

In Massachusetts call 617-577-1017 or fax this coupon to 617-577-8829.

Yes! Tell me more about Maple.

Name _____
 Title _____
 Company or institution _____
 Address _____
 City _____ State _____ Zip _____
 Phone (____) _____

Mail this coupon to:
MathSoft, Inc.
 201 Broadway
 Cambridge, MA 02139
 USA

B95

Maple

WINDOWS/FLYING WINDOWS

Speeding Windows

The basic premise behind Windows acceleration is to free the CPU from most graphics-related processing chores. Video-accelerator or coprocessor chips located on-board an accelerated display adapter off-load these duties from the CPU.

By comparison, standard VGA and Super VGA display cards are merely slower, "nonthinking" conduits for converting CPU-processed digital graphics data into displayable analog color signals. Video-acceleration cards use discrete, fixed-function chips to increase Windows speeds. S3's 86C911, Weitek's W5086, and ATI's proprietary Mach 8 chip, to name just three, can increase performance five- to tenfold.

Fixed-function chips handle graphics chores, such as BitBlts, line/rectangle fills, and font caching, that normally bog down CPU performance. Manufacturer-specific Windows driv-

ers and on-board BIOSes communicate which graphics duties the display-accelerator chip off-loads. It is in these drivers and display BIOSes that manufacturers can gain an edge in speed over competing boards, often while using identical acceleration chips.

Alternatively, coprocessed acceleration cards, such as the TIGA (Texas Instruments Graphics Architecture) TMS34010 and TMS34020, are programmable. Using software-to-hardware communications links at system boot time, a TIGA communications driver is uploaded to the 340x0 processor.

While generally not as fast as fixed-function accelerators, TIGA and other coprocessor boards have a slight advantage over fixed-function chips: You can simply upload any new TIGA software updates from the manufacturer to the coprocessor. With either solution, the benefit to Windows users is speed.

Fixing Functions

ATI's half-length Graphics Ultra card ships with an on-board mouse and an extra bus port in both 0.5- and 1-MB versions. It installed easily after I set the DIP switches. ATI's Mach 8 chip, like S3's 86C911, is a fixed-function accelerator; however, on-board EEPROMs are also custom-programmed for monitor frequency and resolution settings of from 640 by 480 pixels with 256 colors to 1280 by 1024 pixels with 16 colors. The board uses a VBE (VESA BIOS Extension)-compliant TSR driver for DOS applications. (For more on VBE, a standard for integrating the capabilities of graphics adapters, allowing system developers to write universal drivers for all VBE-compliant VGA cards, see Reviewer's Notebook on page 342.)

Windows setup is relatively easy due to the abundant menu choices that confront you during installation. Drivers are placed uncompressed into the Windows subdirectory, and when SETUP executes, it lets you choose the display resolution. ATI's antialiased Crystal Fonts make fonts as small as 6 points easily readable on 14-inch monitors at 1024-by-768-pixel resolution. For objective tests, I used the 1024-by-768-pixel by 8-bit resolution (ATI's

"small fonts/large desktop" configuration) without installing the Crystal Fonts. In Windows, the display is markedly sharper and clearer than with most S3-based cards.

The Crystal Fonts are designed for previewing laser output from desktop publishing, and they work beautifully; however, they slow things down dramatically. The time required to perform WordPerfect scroll tests increased from 12.74 seconds to 86.77 seconds when I added Crystal Fonts. However, the document *did* look as good on-screen as on the printed page. The bottom line is, use Crystal Fonts if you like, but only for serious desktop publishing work.

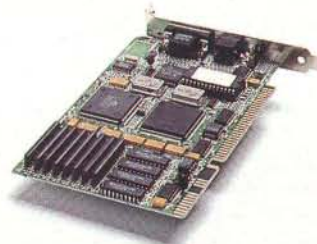

Graphics Ultra

The Graphics Ultra is relatively expensive compared to other S3-based cards.

continued

Why do they call it a dongle?



He wasn't famous. He didn't drive a fancy car, but dressed in his favorite Comdex T-shirt and faded blue jeans, he set out to change the course of the computer software industry. Quite a task for a lonely software developer.

Sitting in front of his

computer, drinking pots of coffee and smoking cartons of cigarettes, he'd write pages

of code.

It took time. Years in fact. But he did it. He wrote the most powerful computer program in the world. Now came the hard part. Selling it.

The Most Powerful Program in the World

Determined to make those long years pay off, he called on every distributor, VAR and dealer in the world. He drove from Beantown to San Diego. Flew from Dublin to Borneo. Everyone loved the program.

So he sold a few. Only a few.

Back in Boston he waited. After a long year

with only 13 orders he set out to see what happened. As he drove across the

country and flew around the world he discovered everyone knew about his program. Everyone had it too.

The Global Marketplace

From Paris to Prague, his program was everywhere in Europe. When he got off the plane in Hong Kong he found his program stacked to the ceiling in every computer store. Amazed in disbelief, he bought a hundred cartons of cigarettes and a hundred pounds of Indonesian coffee and flew back to Boston.

Beaten, battered and bruised he went back to the drawing board. This time he would really change the face of the software industry. He would develop a device that would prevent unauthorized distribution of software programs.

Call It What You Like

He developed a hardware key. His peers applauded his efforts. Finally, a solid solution for revenue protection.

But he didn't know what to call it. He thought of naming it after an exotic place he visited in his travels. Madagascar was a bit too long, though.

"Name it after you, Don!", urged his peers. So he did. Soon everyone was calling the key a dongle, after Don Gall—the lonely software developer who did what he had to do.

You've Come A Long Way, Baby

Today, dongles are different. Fact is, they've come a long way. Leading the industry with security solutions, Rainbow Technologies has changed the face of hardware keys. They work with multiple applications, are programmable and network versions control concurrent usage. And they're always transparent to the end-user.

Sentinel Family from Rainbow

Truth is, more and more developers are using keys. And the Sentinel Family is the most widely used in the world. In fact, over 6,000

developers use Sentinel from Rainbow. Why? They are simply the most effective, reliable and easy to implement keys on the market.

Learn more about securing

your software and how keys provide developers with extra value. Call for a free copy of "The Sentinel Guide to Securing Software." And see just how easy it is to

install a hardware key into your application in just minutes. Try it with our low cost Sentinel Evaluation Kit. Order one for your DOS, OS/2, Windows, Macintosh or UNIX based application.

And remember, when you need a dongle, you need Sentinel—the only dongle Don Gall would use.

European Headquarters
44 0932-570066

Pacific Rim/Latin America Headquarters
714/ 454-2100

Distributors located worldwide.
Call for a distributor near you.

SENTINEL
Securing the future of software

Some call it a dongle. Those who know, call it Sentinel.

RAINBOW
TECHNOLOGIES

NORTHERN EUROPE
4 The Forum, Hanworth Lane
Chertsey, Surrey, KT16 9JX, United Kingdom
tel: 44 0932-570066 ■ fax: 44 0932-570743

CENTRAL EUROPE
Oskar-Messter-Strasse 16
Postfach 1243, D-8045 Ismaning, Germany
tel: 49 089-961 3051 ■ fax: 49 089-961 2617

SOUTHERN EUROPE
2 Allée des Aulnes
78190 Trappes, France
tel: 33 1 3050 4411 ■ fax: 33 1 3050 6276

PACIFIC RIM/LATIN AMERICA
9292 Jeronimo Road
Irvine, California 92718
tel: 714/ 454-2100 ■ fax: 714/ 454-8557

CALL FOR YOUR FREE GUIDE TO SECURING SOFTWARE

Circle 35 on Inquiry Card (RESELLERS: 36).

To Address the Problem of Inadequate Language Skills...

Address the Coupon Below for A Demo Disk on PERFECT COPY™

You know the scenarios: the student who graduates from high school but lacks the language skills to pass the SAT's; the business executive that enters the desktop computer environment, but for lack of language skills, cannot compose a satisfactory letter or presentation.

It is a problem recognized in the highest offices in the land.

It is the problem for which PERFECT COPY™ is the solution.

PERFECT COPY is an educator-designed program that meets the language skills problem head-on in a "whole language" environment. PERFECT COPY covers the educational range from Grade 4 . . . to adult . . . to English as a second language.

It holds the interest of the learner. It reports areas of both strength and weakness to the educator. It helps the teacher to adjust the student's focus to the areas where help is needed most. Its simplicity and effectiveness will amaze you.

A demo disk is available to qualified educators. Phone (416) 266-8840, Fax (416) 266-8939 or mail the coupon.



908 Niagara Falls Blvd.,
North Tonawanda, NY 14120-2060



FREE DEMO DISK

() Please send information and demo on PERFECT COPY™ for

() IBM or compatibles

() Macintosh

() 3-1/2" disk

() 5-1/4" disk

NAME _____

TITLE _____ PHONE _____

ORGANIZATION OR SCHOOL _____

ADDRESS _____

CITY _____ STATE _____ ZIP _____

PERFECT COPY™ is a trademark of Logicus Incorporated and is a Thetis Marketing Group affiliated product.

WINDOWS/FLYING WINDOWS

Perhaps it would be less costly if it came without the mouse and bus port, but you may find them useful. Overall, I give the Graphics Ultra high marks for speed, concise documentation, easy installation, and a rock-steady, clear display.



Fahrenheit 1280

Orchid Technology's Fahrenheit 1280 S3-based half-length card comes in 0.5- and 1-MB sizes and supports resolutions of up to 1280 by 1024 pixels with 16 colors. Both models ship with Sierra's "high-color" RAMDAC. Hardware installation is a breeze; you don't need to set any DIP switches. From a no-nonsense installation menu, Windows reconfiguration is similarly painless. In Windows, an Orchid Set-up icon sets screen resolutions, colors, and font sizes. In addition, the Fahrenheit 1280 has one of the sharpest displays of the S3-based cards I examined.

The documentation is simply excellent and details driver installation for over a dozen other applications. The package also includes DOS utilities for setting resolutions and refresh rates. According to Orchid, the Fahrenheit 1280 will soon ship with VBE-compliant BIOSes (free of charge to current owners).

Although the tests placed it in the median range for Windows acceleration, I found the Fahrenheit 1280 a good value for its \$449 list price because of the extensive DOS applications drivers.

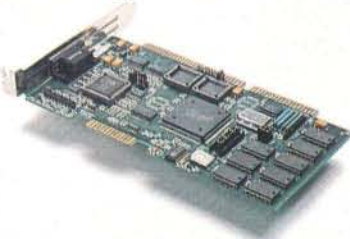

Eclipse II Model 2

The Eclipse II, a 1-MB half-length card from Portocom Technologies, is S3-based and comes in three models. Model 1 comes without a high-color RAMDAC; Model 3 is XGA/high-color compatible. Model 2, my test unit, which ships with Sierra's high-color RAMDAC, installed easily without my resetting the on-board IRQ (interrupt request) jumpers (future boards will have DIP switches). The Eclipse II

No Wild, No Wildlife.

The California desert tortoise is losing ground. Its young are being crushed by motorcycles and off-road vehicles. Sheep and cattle grazing are diminishing an already scant supply of food while mining and road building are destroying the tortoise's natural habitat.



logical indicator of how severely the desert ecosystem is at risk.

The Sierra Club works to save wildlife by saving the wilderness. We have a history of victories. And we believe, with your help, the three-million-year-old desert tortoise can win back its native turf.

The fact is that the tortoise population has declined as much as 90% over the last fifty years. This drop is a true bio-



For more information:

Sierra Club
Dept. DT
730 Polk Street
San Francisco, CA 94109
(415) 776-2211

We'll Spell It Out For You.

Complete Product Line

Total Compatibility

Xellent Quality & Support



See Us At The
Javits Convention
Center of New York
June 23-25, 1992
Booth 104



At CTX, we know that your monitor is how you see the interworkings of your system. That's why we offer a vast line of monitors with non-glare dark screens, automatic/switchable power supplies, and four way tilt/swivel bases as standard features.

CTX products range from a monochrome to a non-interlaced low radiation Super VGA, and the new Professional Series (CPS) models with flat screen technology and front access programmable controls.

Our products are fully compatible with IBM, VGA, XGA, 8514/A, VESA, SVGA, and MacII. We also offer strong warranties and a nationwide servicing network.

Contact a CTX dealer today. And once you look at CTX, your monitor choice is clear.

CTX International
20530 Earlgate Street
Walnut, CA 91789
714/595-6146
Fax 714/595-6293

CTX South
6090-F Northbelt Parkway
Norcross, GA 30071
404/729-8909
Fax 404/729-8805

CTX East
146 Division Place
Hackensack, NJ 07601
201/646-0707
Fax 201/646-1998

CTX Midwest
500 Park Blvd., Suite 425
Itasca, IL 60143
708/285-0202
Fax 708/285-0212

CTX OEM
1445 MacArthur Dr.
Carrollton, TX 75007
214/416-9610
Fax 214/245-7447

CTX

Committed To Xellence

Local Bus Video

Today, 386 and 486 CPUs running at 16- to 50-MHz speeds process information on 32-bit data paths. However, when these processors are coupled with an ISA bus, bottlenecks occur. Graphics data must slow down to ISA's 8- to 10-MHz speeds and travel through ISA's 8- or 16-bit data paths. It's like what happens when traffic on a 55-mph, 32-lane expressway funnels down to 16 or 8 lanes at 30 to 10 mph.

LBV (Local Bus Video) circumvents this traffic jam by managing display data on 32-bit data paths at speeds identical to those of the host CPU (see figure A). LBV provides you with dramatic speed increases for 8-, 16-, and 24-bit color with higher display resolutions. (A single, uncompressed 1024-by-768-pixel by 24-bit screen can contain as much as 3.2 MB of image pixel data.)

Unfortunately, however, there isn't one standard LBV architecture. Considerable confusion has surfaced around the merits and drawbacks of different versions emerging from various vendors, manufacturers, and standards committees.

Taking the Local Bus

Perhaps the simplest route to LBV is to integrate Super VGA chip sets directly on the motherboard as 32-bit ASICs (application-specific ICs) with direct 32-bit CPU data-path connections. Some manufacturers think that etching Super VGA discrete logic directly on the CPU is the way to go.

Emerging and rapid advances in display resolutions and specifications may make both the ASIC and discrete-logic solutions undesirable. Of the accelerator manufacturers I spoke with, most think that LBV should—and probably will—be implemented using 32-bit EISA- and Micro Channel-based bus architectures operating at direct CPU MHz rates.

In addition, VESA (Video Electronics Standards Association) has established LBV committees. At June's 1992 PC Expo, VESA plans to examine emerging and current implementations of LBV connector, signal, and data-

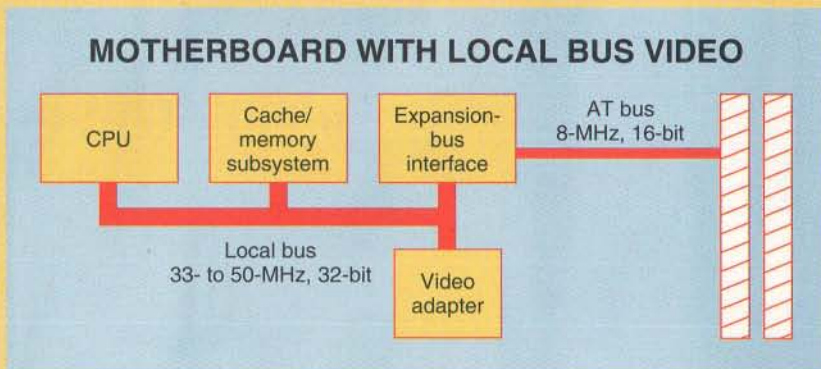

Figure A: The CPU, memory/cache subsystem, and expansion bus interface make up the heart of the motherboard. They are connected by a high-speed synchronous local bus that runs at the speed of the CPU. With this architecture, PC makers are realizing speeds that are four to 16 times faster than those of motherboards built around asynchronous buses, such as ISA, EISA, or Micro Channel.

path structures; meanwhile, manufacturers haven't been waiting for VESA to standardize LBV. Many of them currently produce brand-specific LBV products, and most are hopeful that their LBV implementations will get VESA's nod of approval.

CSS Laboratories' LBV-style motherboards start with EISA's 32-bit bus architecture as a foundation for increasing display I/O. CSS's Preferred 433GE, a 486/33 motherboard, uses proprietary EISA local-bus graphics slots with 33-MHz direct CPU connections instead of ISA's 8- to 10-MHz bus connections. CSS's MaxGraphics/32 accelerator card sits directly in its 32-bit bus and, like the MaxGraphics/16 reviewed here, implements S3's accelerator chip. CSS-supplied 433GE data sheets showed display-speed performance improvements of over eightfold when benchmarked against Tseng Laboratories' ET3000 ISA-based display adapter.

Other manufacturers, such as Portocom, are developing LBV cards based on OPTi's OPTi496 standard. Portocom's Eclipse II LB adapter also uses S3's chip in 32-bit, direct-CPU-connect data paths. It should be shipping by the time you read this.

Jake Richter, a VESA director and president of Panacea, recently described Chips & Technologies' 32-bit LBV-

style platform—which debuted at recent European computer conventions—as “impressive and blazingly fast,” but it is yet another standard. Likewise, Orchid Technology's Superboard, a 50-MHz 486 motherboard, has 32-bit, direct-CPU-connect slots. For LBV acceleration, you must plug in one of Orchid's D Series display adapters, which also function like the Fahrenheit 1280 16-bit ISA bus adapter reviewed here but are customized specifically for LBV performance using its 486/50 Superboard.

Other players entering the LBV arena include S3, Micronics, Trident, Tseng, Headland, Appian, Western Digital, Dell, and Intel, to name just a few. Add emerging graphics and associated technologies to this LBV “stew pot,” such as the MPC motion video specification or Intel's DVI, as well as JPEG/MPEG (Joint Photographic Experts Group/Moving Pictures Experts Group) compression standards, and you can envision rough waters ahead for LBV sales. These days, there is an awful lot of consumer confusion over the swelling number of unsupported LBV configurations.

Whichever way LBV turns, given the number of manufacturers entering the LBV field, you can expect fierce competition, which will ultimately lower prices.

Your Most Important Business Tools Connected at Last.



WindowPhone requires direct access to a single analog line.

The long awaited teleconnection between your PC and phone is here, available **today**. It's called WindowPhone™. And it's ready to work for you, for your customers, clients or patients. And for your bottom line.

WindowPhone creates a window that pops up on your PC screen — to identify your callers and their phone numbers whenever your phone rings.

ACCESS CUSTOMER DATA INSTANTLY

WindowPhone's pop-up window provides you immediate access to detailed caller information — on your screen before you answer or make a call. Each customized entry includes an individual caller notes section, five-number auto-dial feature and storage for maps or photographs.

Linking the power of Caller ID service from your local phone company, your PC and the telephone, WindowPhone is a customer service dream come true. A multitude of telephone management features gives you the smartest way to access and change customer data.



SELECTIVE ALERTING:

CALLER PRIORITY SCREENING

Selective Alerting lets you assign up to five levels of ring tone priority (through your PC audio system) to alert you to the most important calls.



LOGS CALLER NAME, NUMBER, DATE AND DURATION

WindowPhone automatically logs incoming and outgoing calls with the caller's name, number, the date, time and call duration.

WindowPhone™ The Personal Call Manager with Caller ID Teleconnections



UNANSWERED CALL COUNTER AND LOG

If you've been out, WindowPhone maintains your call counter and automatic call log — even if your PC is off. Use the unanswered call window to return calls or store numbers in the phone books. There's even a handy call reminder feature.



ACCESS THOUSANDS!

WindowPhone stores thousands of names and numbers, allowing you to auto-dial all your outgoing calls.

SPEED DIAL

Your 20 most-used numbers can be entered in the Speed-Dial window.



PUT SECURITY FIRST

Manage phone access, block certain numbers (such as 900 calls) and lock up sensitive customer records.



WINDOWPHONE ADVANTAGES WITHOUT CALLER ID

If your phone company doesn't yet offer Caller ID, WindowPhone will still provide all call functions except identification of incoming callers.

WindowPhone is easy to learn and takes just a few minutes to install and use. Help screens are extensive, with icon options designed for the Windows environment. The WindowPhone board and software, operator's manual and registration card are included.

WindowPhone is available from AG Communication Systems, a leader in telecommunications since 1891.

AVAILABLE NOW! \$495*

ORDER TOLL FREE 1-800-424-8559

*plus shipping and applicable sales tax (Visa or MC accepted)



windowphone™

AG Communication Systems
2500 W. Utopia Rd., P.O. Box 52016
Phoenix, AZ 85072-2016

WindowPhone includes: application and set-up software, one half-size Industry Standard Architecture (ISA) 8-bit WindowPhone PC card; one 120 VAC 60 Hz to 6 VDC wall-mountable power converter; one 6-foot RJ-11 modular telephone cord; User Guide; Quick Reference Guide; Warranty Registration Card; and License Agreement. IBM PC compatible. You must have a single party telephone connection to a direct outside line, Windows 3.0 running on an 80286, 80386 or 80486 processor. Two megabytes of RAM recommended, 3.5" or 5.25" high density disk drive and standard hard drive required. WindowPhone is a trademark of AG Communication Systems Corporation. All other trademarks referenced are the proprietary service marks, trademarks or registered trademarks of their respective manufacturers.

Circle 67 on Inquiry Card.

COMPARING WINDOWS ACCELERATOR CARDS

A variety of memory configurations, display resolutions, and available colors mix with various TIGA and fixed-function full- and half-length graphics accelerator cards. (N/A = not applicable.)

	Hercules Graphics Station Gold 16	Hercules Graphics Station Gold 24	Artist Graphics WinSprint 200	ATI Graphics Ultra	Orchid Fahrenheit 1280
Type	TIGA (TMS34010)	TIGA (TMS34010)	TIGA (TMS34020)	Mach-8 (fixed function)	S3 (fixed function)
Size	Full-length	Full-length	Full-length	Half-length	Half-length
Memory/price	1 MB/\$495 2 MB/\$695	1 MB/\$595 2 MB/\$795	1 MB/\$995	0.5 MB/\$699 1 MB/\$899	0.5 MB/\$399 1 MB/\$449
VBE compliance	N/A ¹	N/A ¹	N/A ¹	TSR	BIOS (coming soon)
Number of colors/highest resolution	32,768 colors ² 256 colors/ 1024 x 768	16.7 million colors ² 256 colors/ 1024 x 768	16 colors/ 2048 x 768 or 1024 x 768 256 colors/ 1024 x 768	16 colors/ 1280 x 1024 256 colors/ 1024 x 768 640 x 480	16 colors/ 1280 x 1024 256 colors/ 1024 x 768
Comes with	ImagePrep software; Autodesk product drivers	ImagePrep software; Autodesk product drivers	Windows utilities; AutoCAD GT Express	Mouse/bus port; DOS drivers; CAD drivers	Sierra's RAMDAC; DOS drivers; CAD drivers

¹Uses VGA pass-through.

²16- and 24-bit at 512- by 480- pixel resolution.

supports resolutions of up to 1280 by 960 pixels by 4 bits (16 colors).

Windows reconfiguration is also simple with the Eclipse II; the forthright install/utility menu also contains Lotus 1-2-3, Microsoft Word, WordPerfect, and seven CAD drivers. This allows direct re-configuration and driver installation for these additional applications from one convenient main menu. Portocom's Windows SETUP utility is clever. It whisks you directly into Windows SETUP to select screen resolutions and then takes you back to Portocom's menu. From there, you simply exit into Windows.

The Eclipse II display is a little fuzzy and posted medium to high results for speed. The card is not VBE-compliant, but Portocom plans to ship a VBE TSR driver shortly. However, both hardware and software installations went very smoothly. The documentation, although not slickly produced, is technically excellent. At a \$325 list price, the Eclipse II gets a big thumbs-up for best price-to-performance ratio.



MaxGraphics/16

CSS Laboratories' MaxGraphics/16 1-MB half-length card ships with Sierra's high-color RAMDAC. It supports resolutions of up to 1280 by 1024 pixels and 16 colors. Besides Windows, several CAD and word processing drivers come with it.

The card installs easily even though there are numerous on-board jumpers for IRQ, BIOS, and bus settings. I referred to the manual (sparse and somewhat bland, but technically accurate) to determine how to position the jumpers when I changed refresh rates and monitors. Reconfiguration uses the Windows SETUP routine for resolution selection and driver installation.

It appears, at least from the drivers' floppy disk, that CSS has used plain-vanilla S3 accelerator drivers. The MaxGraphics/16 is not VBE-compliant, and CSS says that it has no plans to become VBE-compliant until S3 releases its VBE-compliant version (1.7) of the 86C911 chip. (See Reviewer's Notebook on page 342 for more on S3/VBE compliancy.)

Inside Windows, the MaxGraphics/16's screen resolution is sharp and solid. Although the card tested in the medium-to-fast range on the acceleration benchmarks, given its \$395 price, you would expect more features, such as menu customization and lots of additional drivers (as you find with Portocom's adapters). I give the MaxGraphics/16 a yawn at this price; however, if you can find it for less—much less—it might prove to be a fair buy.



GraphicsEngine

The GraphicsEngine half-length card from Actix Systems ships with either 1 MB (for \$349) or 0.5 MB (for \$299) of VRAM along with Sierra's high-color RAMDAC. The 1-MB card is the one I tested; it supports resolutions of up to 1280 by 960 pixels with 16 colors. Besides the Windows 3.x drivers, GraphicsEngine comes with 15 applications and CAD drivers and proved to be one of the speedier S3-based adapters.

Installation is simple. None of the rear-mounted DIP switches needs to be reset. There are on-board interrupt jumpers to set for conflicts, and the well-written, professional manual explains everything clearly. The Windows 3.0 or 3.1 reconfiguration is also simple and is accomplished from an elegant installation menu.

The Windows display is crisp, sharp, and undistorted at all resolutions. Inside applications, you can measurably feel the speed differences, especially in WordPerfect. GraphicsEngine also gave PhotoStyler a "turbo" feel. Although it's not VBE-

Portocom Eclipse II Model 2	CSS Laboratories MaxGraphics/16	Actix GraphicsEngine	STB Wind/X Ultra	Diamond Stealth VRAM
S3 (fixed function) Half-length 1 MB/\$325	S3 (fixed function) Half-length 1 MB/\$395	S3 (fixed function) Half-length 0.5 MB/\$299 1 MB/\$349	S3 (fixed function) Half-length 0.5 MB with mouse/\$359 1 MB with mouse/\$439 0.5 MB, no mouse/\$299 1 MB, no mouse/\$379	S3 (fixed function) Half-length 1 MB/\$445
No (TSR coming) 16 colors/ 1280 x 960 256 colors/ 1024 x 768	No (waiting for S3) 16 colors/ 1280 x 1024 256 colors/ 1024 x 768	No (TSR coming) 16 colors/ 1280 x 960 256 colors/ 1024 x 768	BIOS 16 colors/ 1280 x 1024 256 colors/ 1024 x 768	BIOS 16 colors/ 1280 x 1024 256 colors/ 1024 x 768
Sierra's RAMDAC; CAD and word- processing drivers	Sierra's RAMDAC; several CAD and word processing drivers	Sierra's RAMDAC; 15 applications drivers; Windows 3.x drivers	With or without Sierra's RAMDAC (\$40); numerous applications drivers and refresh utilities	Sierra's RAMDAC; TurboWindows 3.x drivers; WinRix paint program; Panacea's AutoCAD ADI drivers; 6 other CAD, word processing, and spreadsheet drivers

compliant (Actix plans to release a TSR), I rate this elegant board as a good value, especially at this price and speed.



Wind/X Ultra

STB Systems' Wind/X Ultra half-length card comes in a wide variety of choices: 0.5 or 1 MB with a Logitech BusMan Mouse (\$359 and \$439, respectively), and either size without a mouse (\$299 and \$379, respectively). You can get any model with or without Sierra's high-color RAMDAC (models without the RAMDAC cost \$40 less). The Wind/X Ultra supports display resolutions as high as 1280 by 1024 pixels with 16 colors. Numerous applications drivers and refresh utilities come with the card.

I installed the 1-MB with-a-mouse adapter effortlessly, although there's a myriad of IRQ, BIOS, bus, mouse, and display-memory jumpers you can set. (The mouse worked right off the bat using default jumper settings.) STB's thin but competent documentation is technically very good.

Windows reconfiguration was equally easy, although not very elegant. In the WINDOWS\SYSTEM subdirectory, you

The Softer Side of Speed

Just because you don't have an extra \$300 to \$1000 to purchase a new video-acceleration card, you don't have to view your trusty old nonaccelerated VGA or Super VGA card with disdain. There's a software alternative available for most cards. Panacea's WinSpeed for Windows 3.0 and 3.1 is a \$79 acceleration driver that installs easily from a 5¼- or 3½-inch floppy disk and can boost performance in some applications by as much as five times. WinSpeed supports 256-KB-, 0.5-MB-, and 1-MB-equipped VGA and Super VGA boards with chip sets from manufacturers such as ATI, Paradise, Trident, Tseng Laboratories, Video Seven, and Zymos, at resolutions of from 640 by 480 pixels to 1024 by 768 pixels in 256 colors.

In the objective tests performed, WinSpeed couldn't compete with the speeds that the hardware accelerators demonstrated, but it did provide noticeable speed improvements (from 10 percent to 30 percent) over the Super VGA adapter alone. For a simple software-only add-on solution, I was surprised to discover that WinSpeed shaved almost 35 seconds off the WordPerfect multifont document-scrolling tests.

If your display card isn't among those listed above, Panacea can tell you whether or not WinSpeed supports it. Many VGA and Super VGA cards are capable of emulating other chip sets. At \$79, you won't find a better, quicker, easier, or less expensive route to increasing Windows speed and application productivity.

WINDOWS ACCELERATION PRODUCTS BENCHMARKS



The benchmark tests consisted of running both graphics- and text-oriented Windows applications. In CorelDraw, I opened Pantone's color-process chart and then timed redispays while opening the color-preview box. In WordPerfect for Windows 5.1, I performed scrolls through a 47.5-KB, 22-page, multifont document (MACRO.DOC). In Aldus PhotoStyler, I timed a 9.5-MB 2048-pixel by 1536-line, 120-dpi, 24-bit Targa file for image regeneration after screen scrolls. I rated BitBlt and memory-to-screen writes using a freeware utility, Windows Speed 1.0, which averages these functions in a Windows video-performance-index rating. (You can find the utility on BIX in the IBM.WINDOWS listings.) I performed each test three times and averaged the results. I checked the tests against controls run on a standard un-

accelerated Super VGA adapter, a Diamond SpeedStar with 1 MB of VRAM, with a Tseng Laboratories ET3000 chip set at 1024- by 768-pixel by 8-bit resolution.

The test system configuration consisted of a Zeos 486/25 EISA with 8 MB of extended memory and two 344-MB SCSI hard drives. For resolutions of from 640 by 480 pixels to 1024 by 768 pixels in both interlaced and noninterlaced modes, I used two multiscan monitors: a 14-inch Relisys RE-5155 and a 14-inch Optiquest 3000 for gauging the display clarity of each card (the Optiquest employs a Sony Trinitron CRT with a 0.24-mm dot-pitch ratio). For resolution tests above 1024 by 768 pixels, I used a 20-inch Nanao FlexScan 9500 monitor. The pointing device was a Wacom cordless puck and digitizer tablet.

Figure 1: In every test, Diamond Computer Systems' Stealth VRAM was the fastest of the S3- and TIGA-based adapters that BYTE tested.

decompress font and system files from drive A and then invoke SETUP to choose resolutions. The Windows display is clear and crisp; however, the objective benchmarks unveiled speeds slower than I had expected. After speaking with technical support and a programmer, STB Systems said that additional drivers providing a 10 percent to 30 percent speed increase would be shipping shortly. If the new drivers truly do increase the speeds, I would seriously consider the Wind/X Ultra, especially at these prices with a Logitech mouse.



Stealth VRAM

Except in minor areas, Diamond Computer Systems' Stealth VRAM is absolutely stunning and blindingly fast. The \$445, 1-MB half-length adapter ships with Sierra's high-color RAMDAC, supporting res-

olutions of up to 1280 by 1024 pixels with 16 colors. The Stealth VRAM ships with TurboWindows 3.x drivers, a WinRix true-color paint program (for 640- by 480-pixel, 32,768-color mode), and Panacea's AutoCAD ADI (Autodesk Device Interface) drivers (see the text box "The Softer Side of Speed" on page 181). Six additional drivers for CAD, word processing, and spreadsheet applications come standard with the product.

The board installs fairly easily without the repositioning of on-board jumpers, but I did have trouble setting rear-panel DIP

The Pros Rate CA-SuperCalc Higher Than Lotus 1-2-3 And Microsoft Excel.

... Says ... and ... who resells both ...
 ... Loden, president of ... built-in defaults." ... Computer Associates and ...
 ... Microsoft reseller Loden ... Computer Associates out- ... Lotus Products, say

VARBUSINESS			
Spreadsheet Report Card			
	CA-SuperCalc	Lotus 1-2-3	Microsoft Excel
Ease of use	7.30	6.50	7.11
Memory Requirement	7.00	5.41	6.14
Ease of programming	6.48	5.86	6.26
Ability to manipulate data	7.31	6.71	7.00
Sorting capabilities	7.50	6.64	6.68
Provision for software security	6.96	5.25	5.10
Report writing capabilities	6.78	5.33	6.17
Ease of use of interface	7.45	6.19	6.77
Software integration capabilities	7.30	6.23	6.78
Ease of data retrieval	7.50	6.78	7.00
Satisfaction with product profitability	6.81	5.75	6.42
Overall quality of product	7.70	7.18	7.53
Provision for customer support	7.52	5.79	6.22
Charges for training time	6.43	5.60	5.71
Provision for technical support	7.34	5.55	5.95
Provision for marketing support	6.69	5.71	5.93
Documentation & product information	6.90	6.70	6.98
Frequency of updates & revisions	6.59	5.75	6.15
OVERALL AVERAGE	7.09	6.05	6.44

Recently, VARBUSINESS conducted a survey of some people who know more about spreadsheets than anyone.

The people who sell, install, and support them for a living. The survey asked hundreds of spreadsheet dealers and resellers all kinds of questions to find out what the pros rate as the best spreadsheet. And the pros told them, CA-SuperCalc.[®]

In virtually every category from ease-of-use to technical support, CA-SuperCalc was rated higher than Lotus[®] 1-2-3[®] and Microsoft[®] Excel.

We're not surprised. While Lotus and Microsoft have been fussing over their many different spread-

sheet versions, we've been stuffing one spreadsheet, CA-SuperCalc, with everything you would ever want. From spreadsheet linking to 3-D graphics and beautiful, presentation-quality output, CA-SuperCalc has it all.

And it runs on just about any PC.

But the best part is the price. At \$149.00, CA-SuperCalc costs less than half the price of Lotus 1-2-3 and Excel. Heard enough? Call 1-800-CALL CAI today for the name of the nearest dealer where you can buy the best spreadsheet there is.

If you're willing to spend a couple hundred dollars less.

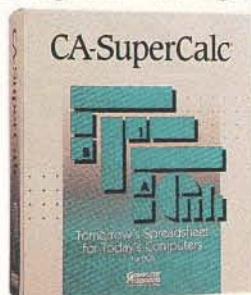

COMPUTER ASSOCIATES
 Software superior by design.

© Computer Associates International, Inc., One Computer Associates Plaza, Islandia, NY 11788-7000. All product names referenced herein are trademarks of their respective companies. © 1991 by CMP Publications, Inc., 600 Community Drive, Manhasset, NY 11030. Reprinted from VARBUSINESS with permission.



Just One Of The 50 Million Americans Who Invests In U.S. Savings Bonds.

Across the country, more and more Americans are planning for the future of their children by buying U.S. Savings Bonds. This Little League slugger gets a Savings Bond for each birthday. As he grows older, his Bonds grow in value. So he's not just getting a gift, he's getting an investment. Find out how U.S. Savings Bonds are making millions of American dreams a reality. Call 1 800 4 US BOND for more information.



U.S. Savings Bonds
Making American Dreams A Reality

A public service of this magazine

WINDOWS/FLYING WINDOWS

switches correctly. The manual is slick, professional documentation with superb artwork. However, the DIP-switch section is a bit confusing; it took a few rereadings before I set the switches properly.

Windows installation is equally slick; after decompressing the driver files into a VRAM subdirectory, a mouse-driven menu system steps you through driver installation. Windows SETUP simply provides a way to select resolution.

In Windows, the display is crystal sharp, and applications simply blitz. In every objective Windows test, the Stealth proved the fastest of the S3- and TIGA-based adapters I looked at. And this card also hustles in the DOS environment, making short work of long directory listings.

Shortly before press time, I spoke with the folks at Diamond about non-VBE-compliance problems. Diamond's new VBE-compliant BIOSes arrived the next day, and I installed them easily. As promised, all my VBE tests and VBE applications software ran perfectly. Diamond is supplying the VBE-compliant BIOS to all Stealth VRAM owners free of charge.

Although the \$445 list price is a bit

steeper than that of most of the other S3-based cards, and leaving aside minor setup difficulties, the warp-drive speeds this accelerator demonstrates secure Diamond's Stealth VRAM card a rock-solid five-star rating and my overall recommendation for today's best buy in acceleration cards.

Future PC Feel

As most of these adapters demonstrate, accelerating the Windows environment improves overall applications performance and increases productivity. And most of these cards come with drivers for a multitude of other applications as well.

At present, adding a display-acceleration card with a driver specific to your application needs is one of the best paths to take to improve the speed of your Windows-based applications. With such a card, you can get a feel for what it will be like to work on tomorrow's 50-MHz, 100-MHz, or higher-performance PCs—today. ■

Greg Loveria is a computer graphics and desktop publishing consultant, animator, and writer in Binghamton, New York. He can be reached on BIX as "loveria."

COMPANY INFORMATION

Actix Systems, Inc.
(GraphicsEngine)
4633 Old Ironsides Dr.,
Suite 310
Santa Clara, CA 95054
(800) 927-5557
(408) 986-1625
fax: (408) 986-1646
BBS: (800) 927-5557
Circle 1329 on Inquiry Card.

Artist Graphics
(WinSprint 200)
2675 Patton Rd.
St. Paul, MN 55113
(800) 627-8478
(612) 631-7800
fax: (612) 631-7802
BBS: (612) 631-7664
Circle 1330 on Inquiry Card.

ATI Technologies, Inc.
(Graphics Ultra)
3761 Victoria Park Ave.
Scarborough, Ontario,
Canada M1W 3S2
(416) 756-0718
fax: (416) 756-0720
BBS: (416) 756-4591
Circle 1331 on Inquiry Card.

CSS Laboratories, Inc.
(MaxGraphics/16)
1641 McGaw Ave.
Irvine, CA 92714
(800) 966-2771
(714) 852-8161
fax: (714) 852-0410
BBS: (714) 852-9231
Circle 1332 on Inquiry Card.

**Diamond Computer
Systems, Inc.**
(Stealth VRAM)
532 Mercury Dr.
Sunnyvale, CA 94086
(408) 736-2000
fax: (408) 730-5750
BBS: (408) 730-1100
Circle 1333 on Inquiry Card.

**Hercules Computer
Technology, Inc.**
(Graphics Station Gold 16+2,
Graphics System Gold 24+2)
921 Parker St.
Berkeley, CA 94710
(800) 767-2443
(510) 540-6000
fax: (510) 540-6621
BBS: (510) 540-0621
Circle 1334 on Inquiry Card.

Orchid Technology
(Fahrenheit 1280)
45365 Northport Loop W
Fremont, CA 94538
(800) 767-2443
(510) 683-0300
fax: (510) 490-9312
Circle 1335 on Inquiry Card.

Panacea, Inc.
(WinSpeed)
Post Office Sq., Suite 4
24 Orchard View Dr.
Londonderry, NH 03053
(800) 729-7420
fax: (603) 434-2461
Circle 1336 on Inquiry Card.

Portocom Technologies, Inc.
(Eclipse II Model 2)
3235 Kifer Rd., Suite 310
Santa Clara, CA 95051
(408) 736-9135
fax: (408) 736-2826
Circle 1337 on Inquiry Card.

STB Systems, Inc.
(Wind/X Ultra)
1651 North Glenville,
Suite 210
Richardson, TX 75081
(214) 234-8750
fax: (214) 234-1306
BBS: (214) 437-9615
Circle 1338 on Inquiry Card.

Easier to work in than a lemon yellow leisure suit.

All too often, writing a GUI application means dealing with complex and unwieldy GUI APIs like MS Windows, PM, or X/Motif.

Which is the equivalent of trying to dress fashionably from a closet filled with nothing but leisure suits and white belts.

Fortunately, there's C++/Views™, the leading C++ class library for quickly developing sleek, platform-independent GUI applications.

C++/Views completely shields you from the ugliness of

the underlying GUI environment and API — slashing development time on GUI programming up to 75%.

Our C++ classes are always in fashion.

The heart of C++/Views is over 100 proven C++ object classes, the most complete C++ library for GUI development available.

All the GUI classes you need are provided: windows, menus, bitmaps, dialog boxes, pushbuttons, graphics, as well as classes for persistent storage, collections, dynamic arrays, and much more.

C++/Views also provides an easy-to-learn, and consistent interface to MS Windows, PM, X/Motif, and others.

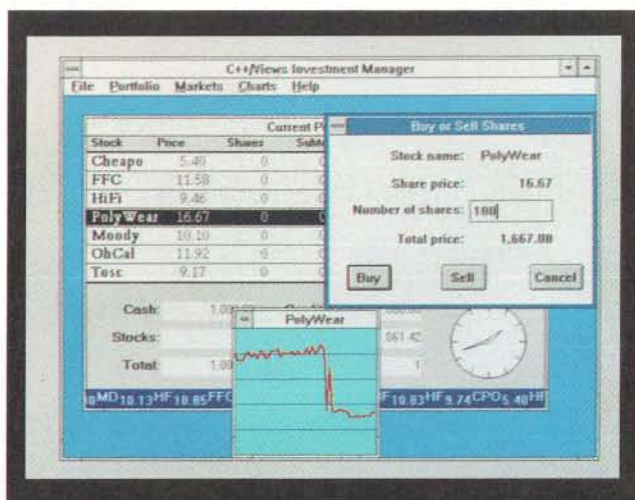

An example of how C++/Views' ease-of-use and portability can make you and your GUI application look good. No matter what you're wearing.

Our free browser is the perfect accessory.

C++/Views comes with C++/Browse™, a powerful source code browser that simplifies C++ development, making it a tremendous learning tool for novice C++ programmers.



Experienced developers will like C++/Browse's excellent navigational capabilities.

Plus, a documentor is included for automatically producing high quality documentation of your classes.

Get into hot C++ technology.

C++/Views combines with any major C++ compiler to give you a sophisticated software development environment.

So even if your wardrobe isn't up to date, make sure your GUI programming is. Order C++/Views today.



+44 (0)71 799 2434 FAX: +44 (0)71 799 2552

Only £250 for MS Windows version (includes source code).

Call for pricing on other platforms.

LIANT

All trademarks belong to their respective companies. Copyright © 1992 by Liant Software Limited, 2 Caxton St., St. James Park, London SW1H 0QE, United Kingdom. Call for a free Liant product catalog.

Circle 55 on Inquiry Card (RESELLERS: 56).

Now £99

for MS Windows version if you currently own any other UI or GUI tool. One per customer. Call for similar special offers on other platforms.

Offer ends 30/9/92

Extra \$10 off for a photo/fax of you in a leisure suit.

1,278 PAGES. 1,311 PHOTOS. 655 CHARTS AND GRAPHS.

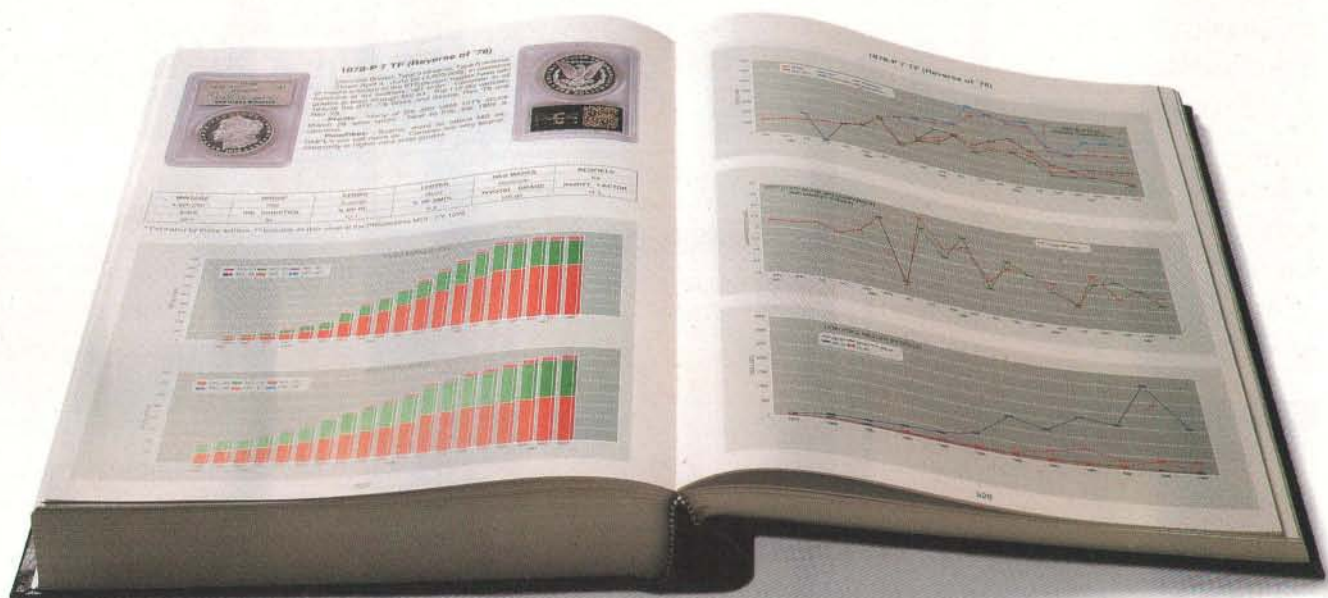

ONE SOLUTION.



The one desktop publishing solution that gives you total-document control—regardless of size.

Ventura.

Take *The Comprehensive*

U.S. Silver Dollar Encyclopedia™ written by John W. Highfill and published by



Highfill Press, Incorporated.

Over 1,200 pages, 81 chapters, 655 charts and graphs, 560 full-color separations... the entire book was produced using Ventura. Now that's publishing.

Then there's Suzanne Carlisle Crowley's lilliputian *Paisley*.

Hand-bound and published by Mosaic Press, tiny tomes like *Paisley* used to take the typesetter up to nine passes

Ventura Publisher® and Ventura DataBase Publisher® are registered trademarks of Ventura Software Inc., a Xerox Company. XEROX® is a registered trademark of Xerox Corporation. *The Comprehensive U.S. Silver Dollar Encyclopedia*™ was written by John W. Highfill, ©1992 by John W. Highfill, and is a trademark of Highfill Press, Incorporated, P.O. Box 365, Broken Arrow, OK 74013. Electronic prepress was provided by EPIC Digital Imaging Center. *Paisley* was written by Suzanne Carlisle Crowley, ©1990 by Miriam D. Irwin, and published by Mosaic Press.

**48 PAGES. 3/4" X 15/16".
20 CHARACTERS PER LINE.**



SAME SOLUTION.

to get it right. Ventura got it right the first time. That's also publishing.

In fact, Ventura handles massive and micro publications with equal ease. It will do the same for your documents. All of them—from flyers, sales bulletins, and newsletters to catalogs, manuals, and corporate publications.

Discover the power of Ventura's complete publishing solution—including Ventura Publisher® 4.0 for Windows,

Ventura DataBase Publisher®, and Ventura Color Extensions.

Visit your local Ventura dealer, or call
(800) 822-8221.

Get the one answer to total-capability DTP.
Ventura. The Document Maker.



Ventura
Software Inc.
A Xerox Company

15175 Innovation Drive, San Diego, CA 92128 • (800) 822-8221

©1992 by Ventura Software Inc. All rights reserved.

Circle 41 on Inquiry Card (RESELLERS: 42).

A FEW OF OUR FAVORITE THINGS

We like to think of the BYTE staff as representative of the community of personal computer users. We have people who use PCs, people who use Macs, and people who use Unix machines. We have people who have moved to Windows. Some of them do most of their work in Windows now, some pop back and forth between Windows and DOS, some use Windows so they can run a favorite application, and some use it mostly as a task switcher.

One thing that's made the move to Windows appealing is the collection of software that runs under Microsoft's graphical environment. Look at all the great applications that either have been developed specifically for Windows or have been transported from the Mac. Word processors, desktop publishing programs, programming tools, spreadsheets, databases, draw and paint programs—they've all come to Windows.

We've adopted a lot of those programs here at BYTE. The products covered in this collection of "favorite things" are the tools we find ourselves using regularly and the tools we pick up to accomplish certain tasks. They're the tools that help us work.

When I first came to BYTE, I got puzzled looks from other editors because I used the DOS version of Microsoft Works as my editing environment. I was drawn to it for its simple, yet surprisingly capable, word processor. The other integrated applications in the Works bundle—spreadsheet, database, communications—meant I didn't need to load down my hard disk with full-size programs, most features of which I'd never use.

I leapt at Works for Windows immediately on its release. The WYSIWYG word processor uses most of the original Works key sequences, while taking on a Word for Windows-style toolbar. Under Windows 3.1, TrueType fonts make the on-screen representation of the document even more accurate.

The other elements of Works for Windows shouldn't be overlooked. Most notable is the spreadsheet, which also benefits from the Windows environment's sleek interface and scalable fonts. My one gripe is that the graphs are still boring and flat.

Works for Windows supports OLE (Object Linking and Embedding) and even

MICROSOFT WORKS FOR WINDOWS

\$199
Microsoft Corp.
1 Microsoft Way
Redmond, WA
98052
(206) 882-8080
fax: (206) 936-7329
Circle 1081
on Inquiry Card.

provides a special application that's accessible through an OLE link: Microsoft Draw. This is a simple polygon-drawing program, but the drawings are very easy to paste into a document and modify later.

Having everything under one roof means all the modules share a single pull-down menu bar and you can open multiple

documents of various types simultaneously—all as child windows of a master application window. Works for Windows is small, fast, and complete. It has freed me from the need to devote space on my Toshiba T2000SX notebook to large, overpowered, dedicated applications.

—Tom Yager

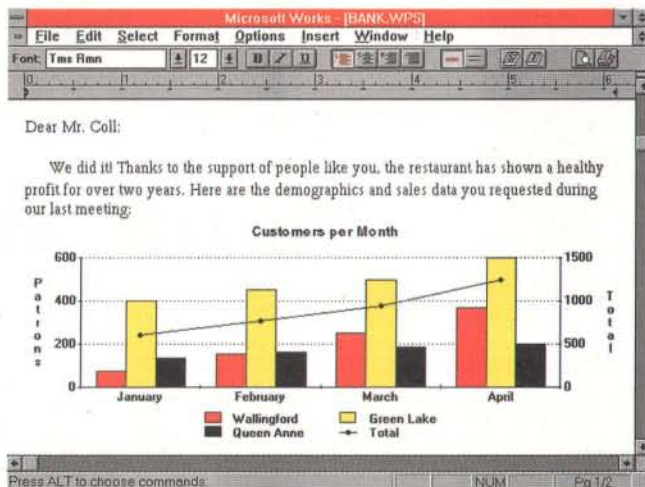

Designed originally for the Macintosh world, Wingz is a perfect fit for Windows; this spreadsheet was born to be graphical. All the inherent benefits of a Windows spreadsheet—effortless graphing and charting, desktop publishing-like presentation features, dynamic links to other Windows applications—are naturals for Wingz.

I often use Wingz to create large tables of product features. Each column contains information on a single product. To verify the data before it gets published in BYTE, I fax each segment of the table to the appropriate vendor. With Wingz, I simply highlight each column in turn, specify it

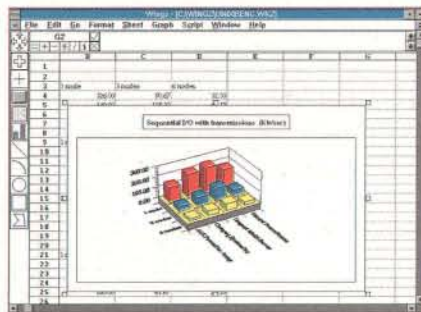

as a report range, and print it. By setting the first row as a title, I can have each report automatically include the row headings. I can verify the printout with a quick WYSIWYG preview; and if it doesn't quite fit on a single page, I can scale down the printout or the sheet itself.

There are a few idiosyncrasies I wish Informix would fix. When you create a

WINGZ FOR WINDOWS

\$499

Informix Software, Inc.
4100 Bohannon Dr.
Menlo Park, CA 94025
(800) 331-1763

Circle 1083 on Inquiry Card.

horizontal bar chart, the entries are listed from bottom to top, the reverse of how they are listed on the worksheet. And although you can highlight noncontiguous data, you can't create graphs that way.

All the stuff this program can do sounds old-hat now, but Wingz was doing it back when it was cool stuff. Maybe that's why Wingz hasn't seen a major upgrade in a while: It was so far ahead, the other guys are still catching up.

—Stanford Diehl

VB (Visual Basic) is to Windows what GW-BASIC was

VISUAL BASIC

\$199

Microsoft Corp.
1 Microsoft Way
Redmond, WA 98052
(206) 882-8080
fax: (206) 936-7329
Circle 1084 on Inquiry Card.

to older versions of DOS: the quickest, easiest way to develop simple applications. VB has introduced countless nonprogrammers to the power of custom applications, and it offers experienced developers a fast track to finished Windows programs.

VB looks like a graphical programming system. It isn't; it still depends on procedural (although event-driven) code. The innovation is in the way VB ties that code, broken into manageable modules, to interface objects.

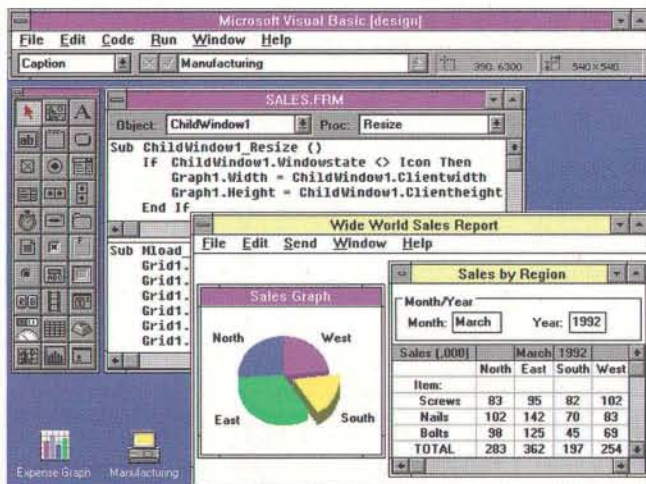

The language is a mix of the extended BASIC dialect and new directives to handle graphical interfaces and event-driven programming. Well-written BASIC pro-

grams are still the easiest to read and understand. And BASIC's similarity to English makes it the easiest "serious" programming language to learn.

It's my hope that VB will spark a trend in programming. Good software need not be difficult to write. Faster computers, more disk space, and more memory make it reasonable to expect development tools to handle more of the burden. VB comes as close as any product to being the perfect development environment.

—Tom Yager

Borland's Turbo Pascal for Windows (TPW) remains one of the best examples of a compiler for which Windows is both host and target. Turbo Pascal's twin hallmarks—convenience and elegant OOP (object-oriented programming) support—carry forward beautifully to the Windows environment. TPW's multiple-document interface, thorough on-line help, and integrated toolset make it a joy to use. Thanks to the handy WinCRT unit, you can run your console-oriented Turbo Pascal programs under Windows right away. When you venture into real Windows programming, you'll appreciate TPW's full encapsulation of the Windows API. I particularly like the DLL support. All Windows language products can call DLLs, but few

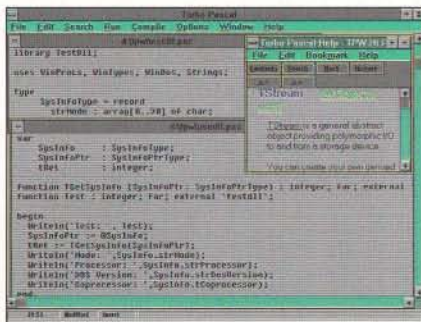

can create them as easily as TPW can.

Of course, there's also the OOP approach to Windows programming. The OWL (ObjectWindows library) now popular with Borland C++ programmers made its debut in TPW. The OWL abstractions

TURBO PASCAL FOR WINDOWS

\$249.95

Borland International
1800 Green Hills Rd.
P.O. Box 660001
Scotts Valley, CA 95066
(408) 438-5300
fax: (408) 439-8088

Circle 1082 on Inquiry Card.

handle dialog boxes and controls and wrap frameworks around them, so you can, for example, easily create your own multiple-document-interface programs. TPW does credit to both Pascal and Windows.

—Jon Udell
continued

In a single package, Borland C++ 3.0 includes everything a Windows developer needs. It's a collection of tools aimed at the serious Windows developer. It has a command-line compiler, an integrated development environment for DOS, a limited Windows-hosted IDE (integrated development environment), a sophisticated debugger, and other programs and utilities. Borland C++ is the most versatile choice if you develop for both DOS and Windows. Besides a full suite of DOS tools, it has an application framework library (Turbo Vision) for text-mode windowing DOS applications.

Wars will rage over whether Borland C++ or Microsoft C++ generates the tightest code, whose environment is superior, and whose class library is built on the best architecture. This is not the forum for such a debate; each package has its strengths. But Borland C++ is a fast compiler that generates well-optimized, bug-free code,

BORLAND C++

\$749
Borland International, Inc.
1800 Green Hills Rd.
P.O. Box 660001
Scotts Valley, CA 95066
(408) 438-5300
fax: (408) 439-8088
Circle 1086 on Inquiry Card.

and it's the environment I prefer.

From inside TCW (Turbo C++ for Windows), the Windows-hosted IDE that comes bundled with Borland C++, you can edit, compile, test, and browse your

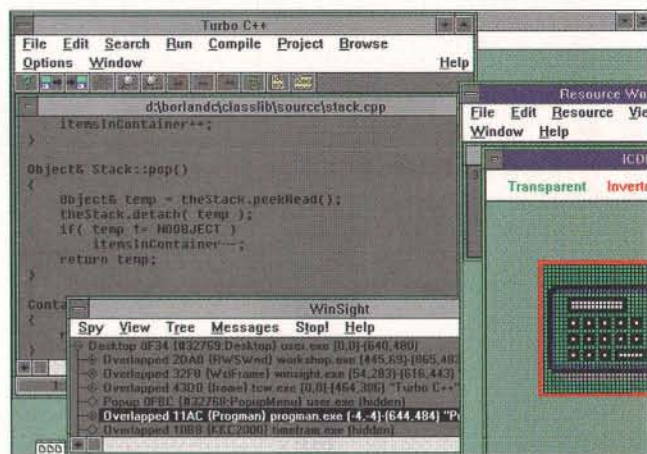

object hierarchy. Unfortunately, to get full optimization or the full-blown debugger, you need to revert to non-Windows-hosted tools.

—Steve Apiki

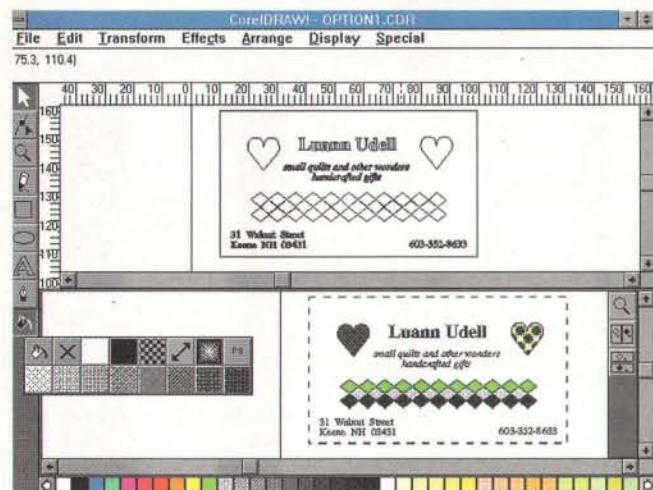

CORELDRAW

\$695
CD-ROM version (includes extra fonts and clip art), \$795
Corel Systems Corp
The Corel Building
1600 Carling Ave.,
Ottawa, Ontario, Canada K1Z 8R7
(613) 728-8200
fax: (613) 728-9790
Circle 1087 on Inquiry Card.

When I need to redesign my wife's business card or illustrate some technical concept for a BYTE article, I usually reach for CorelDraw. As feature-rich as any product in its class, it still manages to keep simple tasks simple. The tool palette,

which seems sparse at first glance, both shows and hides the right amount of information. The bread-and-butter chores—drawing, aligning, and filling objects, and manipulating text—flow straightforwardly from the palette and work the way I expect them to.

But you can get as fancy as you want to. In one case, I needed to illustrate the grid-fitting that ATM

(Adobe Type Manager) and TrueType perform. No sweat—I drew a grid, picked one of the outline fonts included with the package, converted it to its constituent curves, and then did the grid-fitting manually.

Version 2.0 brought several nifty features. You can use an "envelope" that surrounds a piece of text or line art to mold the object into symmetrical or asymmetrical shapes, extrude it into a simulated third dimension, or give it simulated perspective. And you can augment the standard set of bit-mapped and PostScript vector-fill patterns with your own vector-fill patterns made from arbitrary chunks of CorelDraw line art. CorelDraw's import/export filters are another strong point. I've even used the program to transfer art between two Macintosh formats.

—Jon Udell

HOLLYWOOD

\$499
Claris Corp.
5201 Patrick Henry Dr.
Santa Clara, CA 95052
(408) 727-8227
Circle 1091 on Inquiry Card.

Time is almost always of the essence when I need to pull together a presentation. Hollywood lets me do a workmanlike job against the clock.

Hollywood's outliner lets me quickly type out my ideas and juggle the order of my slides for the best flow. I can easily choose slide formats, and with the Color Schemes module, I soon have agreeable background, text, and bullet colors. I haven't time to be creative mixing and matching colors and fills, so I welcome the clean, if bland, appearance of the color templates. The overall look communicates a basic level of professionalism.

My problem with Hollywood stems from its complexity. I don't need to do presentations regularly; I'll typically go weeks between using the program. But when I do need Hollywood, I need it up and running quickly. I find myself walking through a few dark alleys as I try to remember where commands await.

Hollywood's range of features comes at the price of a bumpy relearning curve. But, except when my blood pressure rises against a particularly tight deadline, the benefits of Hollywood compensate for this cost.

—Alan Joch

Mathematica 2.0: the standard for technical computing

The importance of the program cannot be overlooked ... it so fundamentally alters the mechanics of mathematics."

New York Times

Mathematica has the potential to change the world of science at least as much as word processing has changed the world of writing."

InfoWorld

Mathematica is a startlingly good tool."

Nature

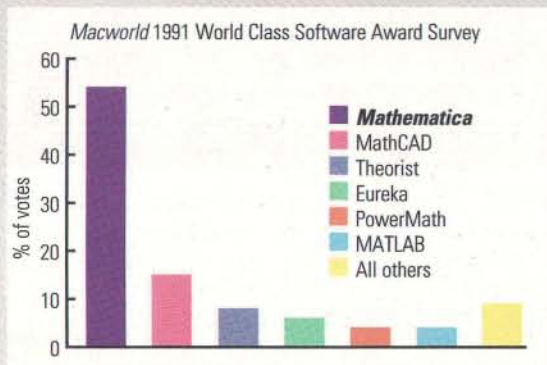

Mathematica has also received best software/new product awards from:

Macworld, 1990-91

MacUser, 1989

Discover, 1990

Business Week, 1988

BYTE, 1989

InfoWorld, 1988

Mathematica is currently available for:

MS-DOS 386, Microsoft Windows, Macintosh, CONVEX, DG AViiON, DEC VAX (ULTRIX and VMS), DEC RISC, HP 9000, Apollo, IBM RISC System/6000, MIPS, NeXT, Silicon Graphics, Sony, Sun-3, and SPARC.

Prices in U.S. and Canada start at \$595. Educational discounts and student versions are available.

Wolfram Research, Inc., 100 Trade Center Drive, Champaign, IL 61820-7237, USA
217-398-0700; fax: 217-398-0747; email: info@wri.com

Wolfram Research (UK) Ltd., P.O. Box 114, Abingdon, Oxon OX13 6TG, United Kingdom
+44 (235) 550 440; fax: +44 (235) 550 445; email: info-uk@wri.com

© 1991 Wolfram Research, Inc. Mathematica is a registered trademark of Wolfram Research, Inc. Mathematica is not associated with Mathematica Inc., Mathematica Policy Research, Inc., or MathTech, Inc. All other product names mentioned are trademarks of their producers. Photo: George Harvey

Available across PC, Macintosh, Unix, and VMS platforms, *Mathematica* includes a full range of interactive numerical, graphical, and symbolic computation capabilities, all linked to the powerful built-in *Mathematica* language. *Mathematica* 2.0 adds still more features to the proven leader in technical computing software, including sound generation and flexible external program communication.

Mathematica has rapidly become the standard for technical computing, with more than a dozen textbooks, a quarterly journal, and several newsletters devoted to the system. *Mathematica* is in use at all of the 50 largest U.S. universities, all of the technical Fortune 50 companies, and most of the world's larger engineering firms. In fact, more than 100,000 technical professionals and students around the world are working with *Mathematica* every day.

To find out what *Mathematica* can do for you, call Wolfram Research at 1-800-441-MATH.

Mathematica 2.0

A System for Doing Mathematics by Computer

For Macintosh information circle 47,
For IBM/Compatible information circle 48,
For UNIX information circle 49 on Inquiry Card.

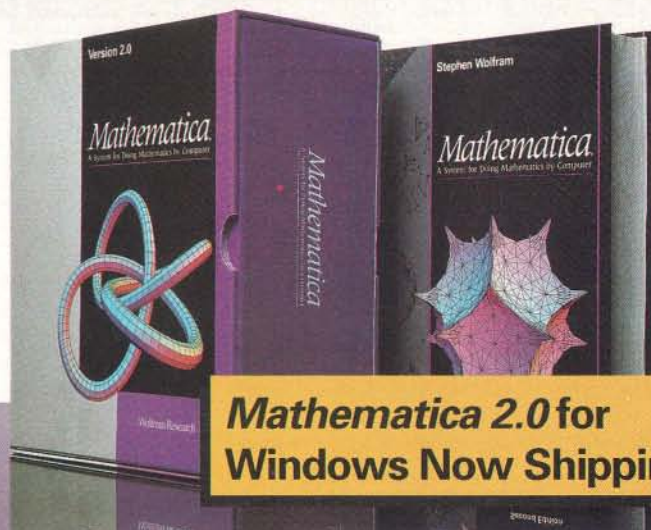

**Mathematica 2.0 for
Windows Now Shipping**

FREELANCE GRAPHICS FOR WINDOWS

\$495

Lotus Development Corp.
55 Cambridge Pkwy.
Cambridge, MA 02142
(800) 343-5414
Circle 1089 on Inquiry Card.

Most people do not need to use a presentation software package every day. I give, at most, five formal presentations during the year. So once I've decided what I want to say, I want a software package that lets me produce good-looking charts and graphs as painlessly as possible. Enter Lotus's Freelance Graphics for Windows.

Freelance Graphics is easy to use. Its SmartMaster templates simplify making stylistic, coherent presentations. It's essentially a fill-in-the-blanks procedure. When you choose a format for your slides, Freelance Graphics prompts you to "type title here." You just click on the area and start typing. Click

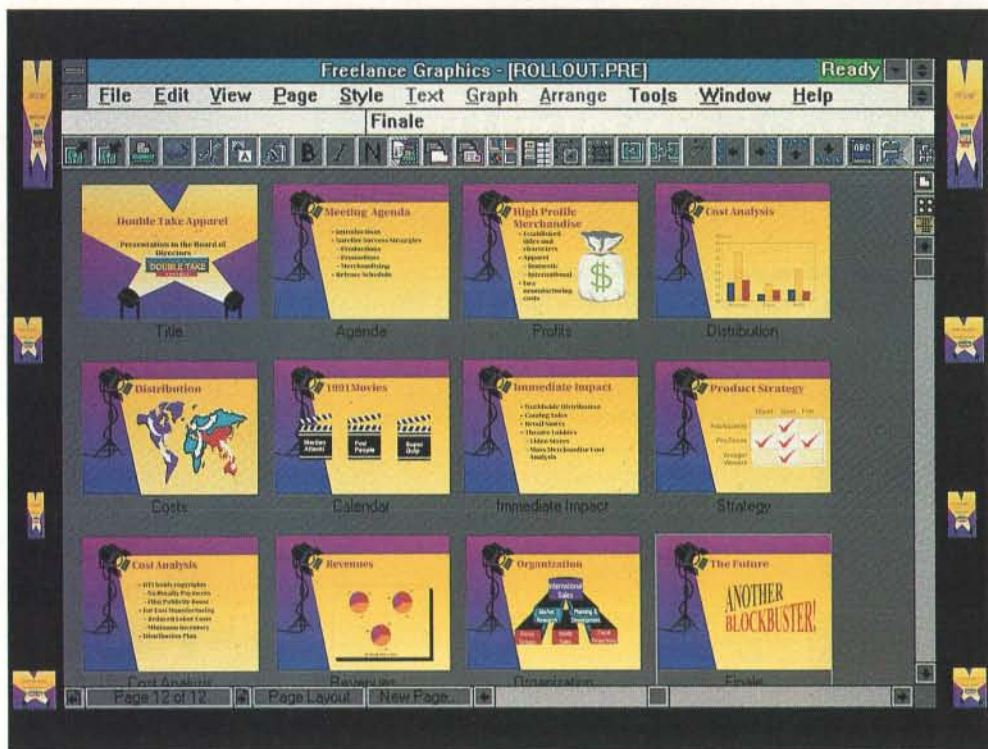

on the "insert symbol," and up pops a symbol library of clip art. Freelance's outliner looks like the ubiquitous yellow legal pad.

Freelance doesn't have the sophisticated technical charts most researchers and scientists rely on. But that lack is a small

price to pay for not having to climb a high learning curve. With Lotus's program, you can produce a professional-quality slide show in less than an hour. In that regard, Freelance has few peers.

—Rich Friedman

WINFAX PRO

\$119

Delrina
Technology, Inc.
6830 Via Del Oro,
Suite 240
San Jose, CA
95119
(408) 363-2345
fax: (408) 363-2340
**Circle 1090
on Inquiry Card.**

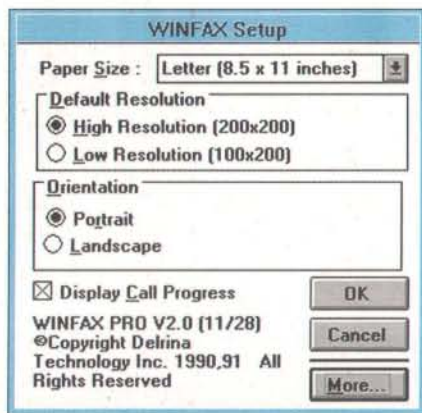

Computers and faxes should be made for each other, but the courtship has been a rocky one. Getting fax modems to work has too often been a head-banging exercise because of the non-graphics-oriented world of DOS and incompatible standards.

Enter Windows, along with the new generation of high-quality Class 2 computer modems that conform to an industry standard. The key to negotiating the mar-

riage of these two is a matchmaker, and that's where WinFax Pro comes in. With this package you can fax documents directly from any Windows application just by printing; the text is sent out through the modem instead of going to your printer. The receiving end gets a high-quality fax document.

WinFax Pro is an almost indispensable time- and work-saver. I can broadcast a fax to any number of people, and I can customize cover sheets and logos with a few mouse-clicks. Because it also receives faxes, WinFax Pro eliminates the pesky roll of annoying curly fax paper on my office floor each morning. At least on my end, it's a giant step toward the paperless office.

—Stan Miastkowski

DYNACOMM 3.0

\$295

Future Soft Engineering
1001 South Dairy Ashford, Suite 101
Houston, TX 77077
(713) 496-9400
Circle 1088 on Inquiry Card.

DynaComm 3.0 blends text- and graphics-based computing with an elegant interface. It adds Windows elements as appropriate, but otherwise, you work with your conferencing system or BBS on its own terms.

DynaComm has more features than I can enumerate here, including INT 14 support for dealing with network communications servers, a reasonable list of transfer protocols, a built-in viewer for looking at images in the GIF format, and a robust scripting language. DynaComm presents it all under a multiple-document interface design that makes it easy to organize communications windows, scripting windows, and collections of buttons.

—Steve Apiki

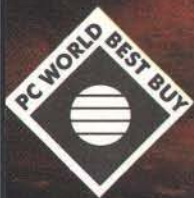

Introducing the first notebook computer designed to make Windows™ a breeze.

Just turn it on and go. It's that simple. The new TI TravelMate™ 3000 WinSX™ package is engineered to meet the challenges of running Windows on a notebook computer. That's why it comes with MS-Windows® 3.0 and MS-DOS® 5.0 already installed on the 60MB, 80MB or 120MB hard drive. So within seconds, you're into Windows and ready to load your application software.

But the TM3000 WinSX offers so much

more. Like clicking in and out of applications with a specially designed pointing device. An extra-large, easy-to-see cursor that keeps your place as you move from screen to screen.

And Battery Pro™. Designed to extend battery life when working in Windows, it suspends functions you're not using while keeping calendars and other background programs current. So you can pick up

where you left off.

Best of all, these Windows features, and more yet, come in the industry's smallest, thinnest and lightest 386SX™ 20 MHz notebook computer.

Finding out more is a breeze, too. For the name of a dealer near you, call 1-800-527-3500.

 **TEXAS
INSTRUMENTS**

Think of Act for Windows as a customizable contacts database surrounded by a set of modules for handling different functions: a WYSIWYG calendar for appointments and to-do items; a word processor with Houghton Mifflin's spelling checker; letter and memo templates; activity reports; a macro builder; and a telephone list and dialer. In short, Act for Windows is a complete environment for people who spend much of their time contacting, meeting, and following up with other people.

Besides the graphical interface, Act for Windows offers many improvements over its DOS counterpart. The contacts database has 71 customizable fields and adds phone number, time, date, currency, and integer field types. You can schedule recurring events, prioritize events, and reschedule an event by clicking and dragging it across the daily, weekly, or monthly calendar. Unlike the DOS version, Act for Windows does not print index cards or mailing labels, run on a network, support fax modems, or record business expenses.

ACT FOR WINDOWS 1.0

\$495
 Contact Software International
 1840 Hutton Dr., Suite 200
 Carrollton, TX 75006
 (214) 919-9500
 fax: (214) 919-9750
 international: 44 (0) 753 833317
Circle 1093 on Inquiry Card.

I can take contact information and word processing files compiled with Act and export them as dBase and RTF files, respectively. Act doesn't support OLE but does support DDE, with predefined links to Objectvision, Word, Ami Pro, and Word-

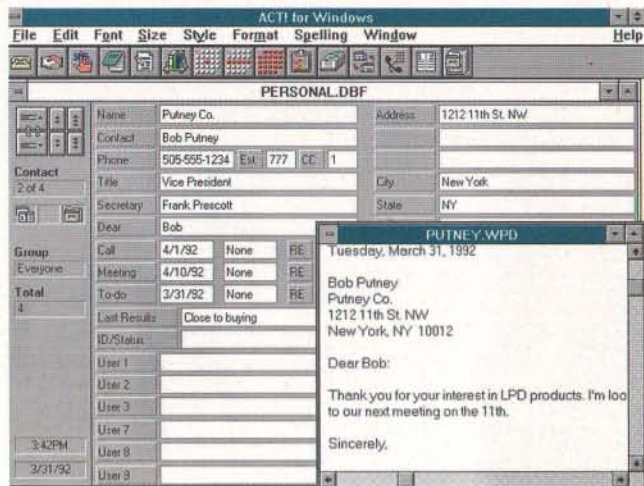

Perfect for Windows. On-line help and an intuitive user interface make mastering Act for Windows quick and painless. I recommend it if you need to keep in contact with dozens, or even hundreds, of people.
—Rob Mitchell

LANTASTIC

\$299
 Artisoft
 691 East River Rd.
 Tucson, AZ 85704
 (602) 293-4000
 fax: (602) 293-8065
Circle 1094 on Inquiry Card.



Novell NetWare's high pricing gives many a small business pause. For those without deep pockets and a full-time system administrator, Artisoft's peer-to-peer LANtastic is a good solution.

Administering a network isn't simple, but Artisoft's LANtastic for Win-

dows makes the chore simple and elegant. This add-on utility makes full use of Windows' abilities: pull-down menus, icons, graphics, and multitasking. And you don't need Windows on each system in your network (although that's the optimum setup).

To use LANtastic for Windows, you need a LANtastic network. With LANtastic for Windows on my system administrator's workstation, I can easily handle several network tasks at the same time. I can also easily change the network's shared resources with a few mouse-clicks.

With LAN utilities like this, full-time system administrators could very well become an endangered species.

—Stan Miastkowski

If you've got a CD-ROM drive, you'll appreciate an electronic encyclopedia. Compton's Multimedia Encyclopedia delivers textual data with images, sound, and animation.

Compton's interface gives you a variety of ways to access information. If you have a particular subject in mind, you can go to the Finder and enter the term, or you can use Idea Search, which locates requested terms within documents. There's a Topic Tree for browsing through broad categories of knowledge and a U.S. time line for jumping right to historical events.

Once you find an article of interest, you can pull it into a window and browse through it. By clicking on intuitive icons (e.g., a camera or headphones), you call

COMPTON'S MULTIMEDIA ENCYCLOPEDIA

\$895
 Compton's NewMedia
 722 Genevieve, Suite M
 Solana Beach, CA 92075
 (800) 532-3766
Circle 1092 on Inquiry Card.

up images, charts, audio passages, and animated sequences. Compton's does not support hypertext-style links, although you can look up the meaning of any word by double-clicking on it.



Compton's is a wonderful research tool. It should improve your productivity at work, as long as you don't spend too much time browsing. It's a great diversion, too.

—Stanford Diehl

Obsolete Icon.

roducing AST's New Power Premium® Family. With Microsoft® Windows™ performance 4½ times faster than Dell® 3½ times faster than Compaq® and 1½ times faster than IBM® and NEC®, AST's new Power Premium computers have put this familiar Windows icon on the endangered species list.

Windows Performance Benchmark

AST Power Premium 4/33 **6.678**

3.257 NEC PowerMate® 486/33i (Local Bus)

2.865 IBM PS/2™ Model 95 XP 486 8595-OKD (XGA)

1.830 Compaq Deskpro® 486/33M

1.438 Dell PowerLine® 433DE

Based on Graphics WINMARK™ results of testing performed on 33 MHz 486DX systems in 640x480 resolution with 256 colors using PC Magazine Labs Windows Benchmark software version 2.50.

From the creators of the world's first fully upgradable systems, comes a new generation of state-of-the-art desktop computers featuring:

Premium VGA Graphics. Unequaled speed is just the beginning. Our innovative subsystem supports enhanced video resolution modes of up to 1280 x 1024 and can display over 32,000 colors simultaneously.

Cupid-32™ Upgradability. AST's award-winning Cupid-32 technology is still the industry's best, most complete upgrade solution.

Extended Industry Standard Architecture (EISA). Make full advantage of today's EISA I/O cards while protecting your investment in existing ISA hardware.

AST FlashBIOS. Our simplified, software-based upgrade makes updating your Power Premium's BIOS quick and easy without chip replacement.

High-Performance Processors With Cache. Built into each Power Premium is a powerful Intel486™ or Intel386™ processor and an ample supply of fast-access cache memory.

To receive your FREE video, "AST's Power Premium: Innovation Reinvented," call 1-800-876-4AST.

AST markets products worldwide, for more information call AST International on (714) 727-9292. FAX to (714) 727-8585. AST is a supplier to U.S. government agencies, General Service Contract number GS090092ACS0064. AST, AST logo and Premium registered and Cupid-32, Cupid-32 logo, and the Intel Inside logo are trademarks of AST Research, Inc. The Intel Inside Logo is a trademark of Intel Corporation. All other trademarks and product names are trademarks or registered trademarks of their respective companies. Copyright © 1992 AST Research, Inc. All rights reserved.

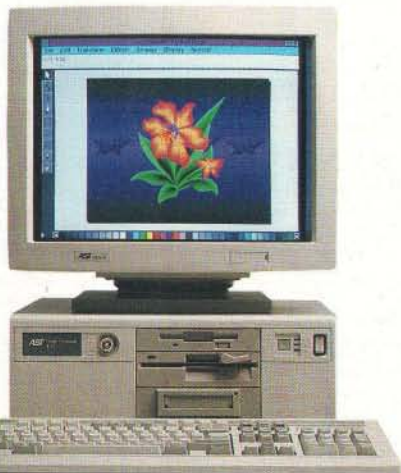

AST
COMPUTER®

The Power Of Choice.

Circle 330 on Inquiry Card (RESELLERS: 331).

Nothing can replace paintbrushes, pencils, pastels, and pens. But Fractal Design's Painter is a remarkable digital approximation of those tools. Born on the Mac, Painter is a "natural-media" graphics package. It tries to simulate the look and feel of oil and waterpaint, chalk and charcoal, crayons, pencils, and pens. You can make paint smear, chalk smudge, ink blot, and watercolor drip. Images created with Painter have a warmer, more fluid look than you get with other packages (excluding Oasis, a forerunner of Painter).

There's a fun aspect to Painter, but it can be used as a serious package for corporate and commercial graphics. Annual reports, promotional materials, and press kits are all dressed up with colorful illustrations, usually done in natural media.

With Painter, an in-house designer can send creations to a program like PhotoStyler for preparing color separations.

Painter requires 6 MB of RAM; 20 MB of free disk space is recommended. Don't try this package on less than a fast 386.

Because its tools are sensitive to pressure, Painter is best used with a stylus and digitizing tablet. You can use a mouse, but it's not the same.

Painter is the most tactile, responsive

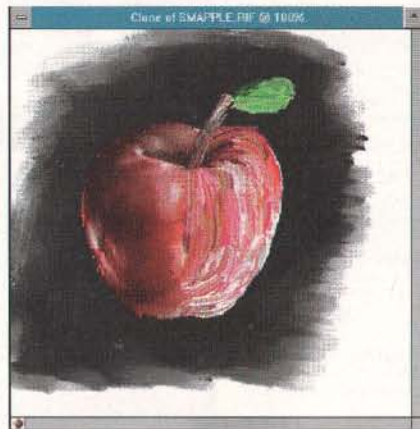

PAINTER

\$399
Fractal Design Corp.
P.O. Box 2380
Aptos, CA 95001
(408) 688-5300
Circle 1085
on Inquiry Card.

graphics package yet. Every computer artist should check it out.

—D. Barker



PHOTOFINISH

\$199
ZSoft Corp.
450 Franklin Rd.,
Suite 100
Marietta, GA
30067
(404) 428-0008
Circle 1096
on Inquiry Card.

will let you do almost anything with a digital image, but they are designed for graphics pros and have more capability than most people in the office need.

For image jobs that don't require PhotoStyler's power, I have started using PhotoFinish from ZSoft. It has the basic filters for cleaning up scanned images—color or gray-scale—by sharpening edges, adjusting brightness and contrast, equalizing color shades, erasing unwanted objects, and so on. It will convert

color scans to gray-scale.

PhotoFinish isn't just for cleaning up scans, though. It has a box of tools you'd find in a paint package, including brushes, pens, pencils, paint roller, airbrush, smudgers, and color blenders. The group of selection tools has a handy pair of scissors that make it easy to cut a complex, polygonal shape in one picture and paste it into another. The magic wand, on the other hand, tends to be inaccurate.

What I like most about PhotoFinish is its ease of use and simplicity. ZSoft is targeting this package at people who aren't graphic artists but sometimes have to incorporate a scanned image into a document. As much as I like PhotoStyler, PhotoFinish is less daunting.

—D. Barker

Image editing isn't always pretty. Unless you're just trying to sharpen edges or clean up noise in a scanned photo, it can be a complex operation. Programs like PhotoStyler (under Windows) and PhotoShop (on the Mac)

Every once in a while, a PC program will come along that has the potential to increase a user's productivity by an order of magnitude. The spreadsheet was such a program. And, by the incorporation of electronic handbooks, Mathcad, a mathematical solver program, is another.

With these electronic texts, a user can take an equation, formula, or diagram from a technical reference book, paste it into a Math-

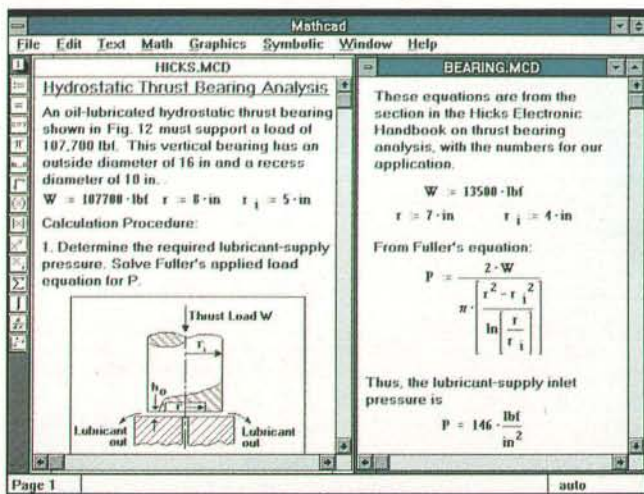

cad document with one mouse-click, change the values if necessary, and then

MATHCAD

\$495
MathSoft, Inc.
201 Broadway
Cambridge, MA
02139
(617) 577-1017
Circle 1097
on Inquiry Card.

calculate the results. This certainly beats lugging those technical tomes around, not to mention having to do the math yourself.

At this point, MathSoft is offering two handbooks for use with Mathcad: Machine Design and Analysis

from Tyler G. Hicks' *Standard Handbook of Engineering Calculations*, (New York: McGraw-Hill, 1985) and Shackleford's *The CRC Materials Science and Engineering Handbook* (CRC Press, 1991). The handbooks are priced at \$99 and \$149, respectively. More handbooks are on the way.

—Rich Friedman

Effortlessly contour and colormap surfaces generated from random sample points.

Pull a lever to adjust a variable, as the revolutionary Graphics Equalizer™ animates changes to your curve-fits and formulas on-screen.

Automate your presentation with master slides, outliner, speaker & handout notes.

View and organize entire presentations at a glance with the visual slide sorter.

Pop up the extraordinary graph gallery of over 160 business, technical, and statistical graph types.

Access your numbers instantly from your favorite Windows or DOS spreadsheet.

Hot-link multiple data files directly to Stanford Graphics' proprietary 4-D 70-trillion cell spreadsheet.

Animate the 3-D rotation of your graph and its actual data.

Instantly identify & modify your data points with the Intelligent Data Cursor™. Simply drag a bar or line to change a cell in your spreadsheet!

Click on the Calculator for on-the-fly business, financial or scientific computations.

**NEW!
VERSION
1.01**

STANFORD GRAPHICS FOR WINDOWS

Finally...presentation graphics with numerical clout!

Does your presentation software give you all beauty and no brains? Where is the substance behind those pretty pictures? What if your presentation program had enough data-handling muscle to meet the needs of business *and* statistical *and* scientific users?

Presenting Stanford Graphics for Windows, the first graphics package to offer both state-of-the-art presentation features and powerful analysis capabilities.

With on-screen curve fitting, formula solving, statistics, and data manipulation, Stanford Graphics advances both the art and science of technical presentations.

"Stanford Graphics offers the best of both worlds. It combines top-notch presentation features with unprecedented technical sophistication. We were greatly impressed."

—Infoworld,
Sept. 16, 1991



All this and Windows too. Stanford Graphics takes full advantage of the latest in Windows 3.0 and 3.1 technology, with sophisticated DDE, OLE, and TrueType font support.

Stanford Graphics for Windows: Presentation and Analysis. Finally, form *and* substance.

3D+ 3-D VISIONS

Call Toll Free for Details

1-800-729-4723

2780 Skypark Drive, Torrance, CA 90505
Tel:(310) 325-1339 FAX:(310) 325-1505

STANFORD GRAPHICS™
PRESENTATION & ANALYSIS

WINDOWPHONE

\$495
 AG Communication Systems Corp.
 2500 West Utopia Rd.
 P.O. Box 52179
 Phoenix, AZ 85027
 (602) 582-7000
 fax: (602) 582-7111
Circle 1095 on Inquiry Card.

WindowPhone is a package that you either love or hate; you use it all the time, or you feel it's a gross waste of valuable disk space. Basically, WindowPhone is a fancy phone dialer with some nice bells and whistles that are easy to become attached to. It connects directly to any standard telephone outlet (RJ-11).

For example, if your phone system supports Caller ID, WindowPhone pops up a window identifying the caller. A call log keeps a record of incoming and outgoing

calls, including unanswered calls, even when your PC's power is off. You store phone numbers in three personalized phone directories.

WindowPhone lets you add notes, maps, and photographs to every phone-book entry. To auto-dial any number in the directory, you just point and click your mouse. You can password-protect private numbers and block certain numbers. If you really want to get ruthless, you can assign special rings to important callers and eliminate interruptions from "less important persons." If you work in Windows constantly, WindowPhone is a handy way

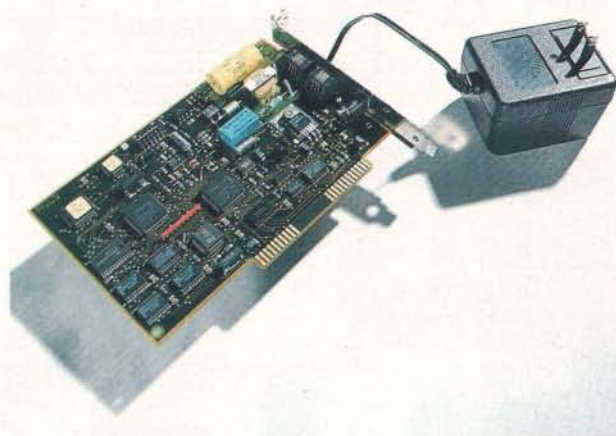

to marry your phone to your PC.

The package includes the software, one half-size 8-bit PC card, one 120-volt AC wall-mountable power converter, and a 6-foot standard modular telephone cord.

—Rich Friedman

WinCli Pro 3.0 is an inexpensive program that adds a command-line interface to Windows. But wait, you say. Why should Windows need a command-line interface?

Well, command lines can be easy to use. When I want to move an entire directory structure from one location to another, it is much easier to drag it graphically. However, when I'm removing dozens of temporary and backup files from a directory, it is much simpler to type `del *.tmp` than to select them all individually and delete.

But wait, you say again. Windows has a command-line interface: Just double-click on the DOS icon and press Alt-Enter. Yes, but what if I don't want to actually run DOS programs? All I want is a simple little program that lets me manipulate files and quickly launch applications.

WinCli provides a DOS syntax and command set. It also has a nice file manager, a clock, a screen saver, and password protection; I haven't opened the Windows

WINCLI PRO

\$35
 Eschalon Development, Inc.
 110-2 Renaissance Sq.
 New Westminster, BC,
 Canada V3M 6K3
 (604) 520-1543
Circle 1098 on Inquiry Card.

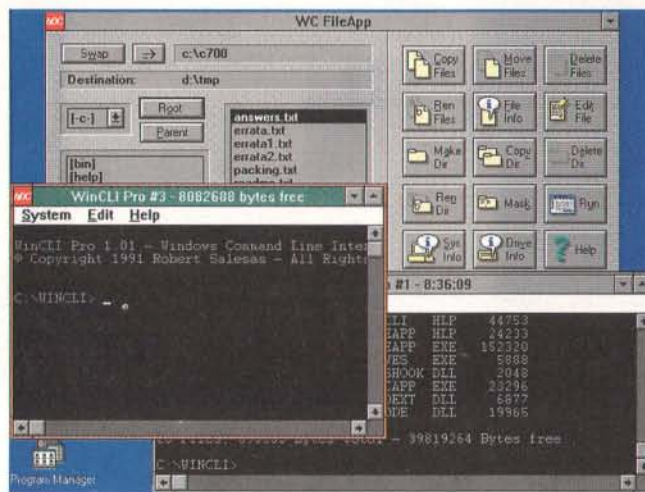

File Manager since loading them.

WinCli's most obvious restriction is the lack of batch files or other type of scripting interface. You can always launch a DOS batch file, but the whole point, at least for me, is not to load the DOS box. Another

problem is speed; WinCli writing to the screen is an exercise in patience.

Despite its limitations, I recommend WinCli Pro. It's a productivity tool well worth the investment.

—Raymond GA Côté

More Windows 3.0 is one of the handiest Windows utilities, especially when I'm doing desktop publishing, since I don't have a large screen.

If you have a standard VGA screen, you can, change your view of a document or worksheet by clicking on the scroll bars, but that can be a pain. More Windows creates a virtual screen that can be up to 66 percent larger than your actual screen size.

What I like best is how you move around this virtual screen; it's called *panning*. You bump the mouse against the edge of the screen, and your view moves.

Installation is a snap. It creates a MOW-IN icon that lets you turn the utility on and off. More Windows won't help much with some applications (e.g., telecommunications), but I find it useful when I'm working with PageMaker under Windows 3.0.

—Anne Fischer Lent

MORE WINDOWS

\$99
 Aristosoft
 6920 Koll Center Pkwy., Suite 209
 Pleasanton, CA 94566
 (510) 426-5355
Circle 1101 on Inquiry Card.

Introducing Power Windows For Project Managers.

The #1 Rated Project Manager Now Available For Windows.

Power changes people. Especially project managers.



They're working smarter and faster with new CA-SuperProject® For Windows. It's the world's most advanced, efficient and reliable project management software

— and now it's incredibly easy to use.

Total power is yours with just a few mouse clicks. Create and edit projects. Specify resources, task types and durations. Define integrated sub-projects. Build top-down hierarchies and task-

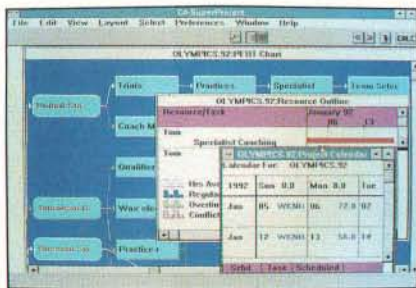

Report the status of your project with detailed Gantt, PERT, WBS and Cost/Resource charts. dependency relations. Link multiple projects together for cross-project leveling. Perform extensive "what-if" analysis, revising schedules as projects progress. You can bet your career on its

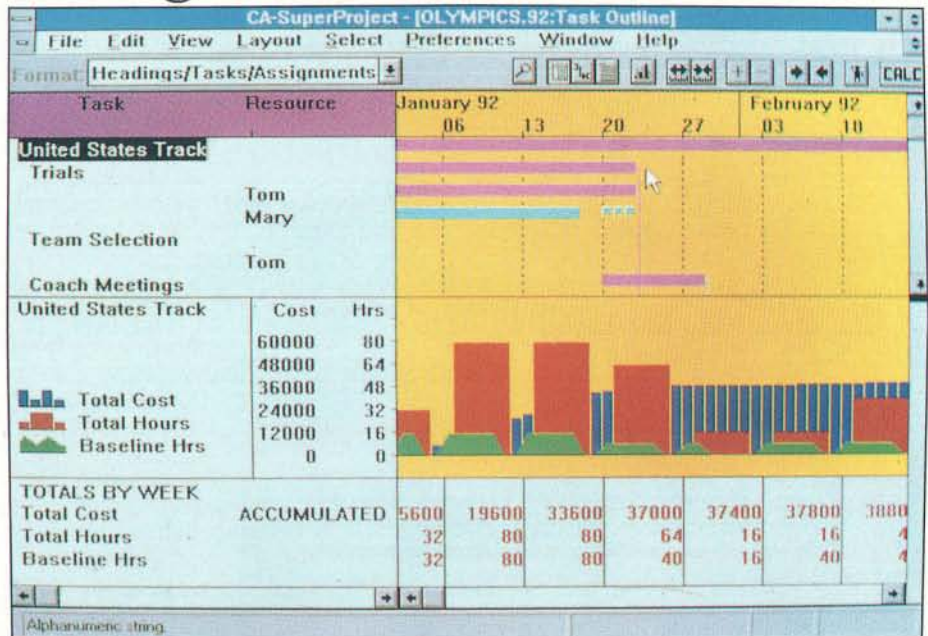

Manage with power, using tools for sophisticated planning, comprehensive resource management, tracking and controlling.

advanced and efficient scheduling algorithms.

A recent study of the five leading project managers proved it. Each was assigned the same



ing days—leaving Microsoft Project, Timeline 4.0, Project Workbench and Project Scheduler in the dust.



There's also a wide array of state-of-the-art graphics and detailed reporting tools to help bring your projects to life.

For your free Demo Disk, call 1-800-CALL CAI. Call today.

And find out what our power windows can do for you.



CA-SuperProject® For Windows

© Computer Associates International, Inc., One Computer Associates Plaza, Islandia, NY 11788-7000. All product names referenced herein are trademarks of their respective companies.

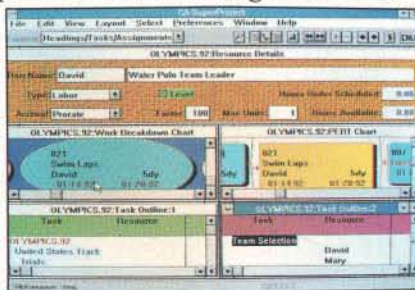

Show multiple views of the same project or different projects simultaneously.

project, but the finish dates varied by as much as five months. CA-SuperProject For Windows finished first in 214 work-

Circle 19 on Inquiry Card.

CONVERSION ARTIST

\$149.95
 North Coast Software, Inc.
 P.O. Box 343
 Barrington, NH 03825
 (603) 332-9363
Circle 1102 on Inquiry Card.

As someone who works on software reviews, I deal with a lot of screens captured from applications. Reviewers send me screen shots in all sorts of formats. But BYTE's design department ultimately wants TIFF files, because that's what it transmits to the service bureau that does color separations for the magazine.

There are a dozen good programs for converting bit-map image formats, but I've settled on North Coast Software's Conversion Artist. This package showed up one day when I was having a hellacious time turning a PCX file into a GIF file. Call it serendipity. I loaded the software and called up the misbehaving PCX. Con-



version Artist brought it up on-screen in a few seconds.

Converting an image is simple. You click on the file you want and then pick the target format. If you've got a mess of files to convert, you can set them up as a batch process. Conversion Artist can handle just about any file format. In addition

to the usual PC file types and MacPaint graphics, this package can also import Silicon Graphics RGB, Sun RAS, and Amiga IFF formats.

But Conversion Artist doesn't just convert images; it also captures them, grabbing either the entire screen, the live window, or a user-defined area. The package can help you save disk space by reducing the number of colors in an image (e.g., from 32-bit down to 16-bit) and by applying compression to image files.

In the world of publishing, where deadlines are always at the door like a barking dog, you need tools you can rely on. Conversion Artist hasn't let me down yet.

—D. Barker



TAKENOTE

\$69.95
 ButtonWare, Inc.
 325 118th Ave. SE,
 Suite 200
 Bellevue, WA
 98005
 (206) 454-0479
 fax: (206) 454-1838
**Circle 1099
 on Inquiry Card.**

Of course you don't need a computer to take notes or keep phone numbers and addresses. But the right software can let you do things with those notes and numbers that you'd be hard-pressed to do with note cards. Try searching through a notebook to find every phone call in which

you discussed, say, Windows software. ButtonWare's TakeNote is the best program I've worked with yet for keeping together and sorting through the kind of data I acquire and use in a day at the office: contact names, phone and fax numbers, records of conversations. It's an electronic card file and notepad combined. All in-

formation is kept on cards, which have labeled fields for names, addresses, phone numbers, comments, and so on. (There's also a field for birthdays, which seems silly.) Besides cards, there are templates for business cards, credit cards, inventory (e.g., software, music, and videos), personnel records, recipes, and free-form notes.

Once you've got the information—those hundreds of business cards collected at Comdex, for example—into the program, you can search through it with the press of a button. The search engine looks for any text in any cards and can even search on the basis of "sounds like." TakeNote will also dial numbers for you. (Just click the red phone icon at the top of the screen.)

TakeNote looks like a stack of cards, is easy to figure out, and works smoothly. Without this program, my desk would be even messier than it is.

—D. Barker

THE FAR SIDE COMPUTER CALENDAR

\$69.95
 Amaze, Inc.
 11810 115th Ave. NE
 Kirkland, WA 98034
 (206) 820-7007
 fax: (206) 823-0568
Circle 1130 on Inquiry Card.

It took syndicated cartoonist Gary Larson to make us jaded keyboard crunchers crack a smile. The Far Side Computer Calendar puts some fun into the start of another working day. Larson's admittedly quirky humor isn't for everyone; you either love Far Side humor or hate it. Somehow, however, I have a hunch that Far Side humor is a perfect match for most serious computer users. Amaze realized that folks wouldn't lay down the bucks for computerized comics.

So, it made its program do something. The Far Side Computer Calendar is a full-fledged calendar that's full of surprises: from animated icons of ringing telephones and flying airplanes to randomly appearing animations (my favorite is the iceberg full of penguins that floats across the screen).

The Far Side Computer Calendar is available in Windows, DOS, and Mac versions. To my mind, it's one of the essential computer programs.

—Stan Miastkowski

NEW!
LIST PRICE
\$299
with 2 Year warranty

Now Shipping! 16 million colors
for Windows®, AutoShade®, 3D-Studio® and more.

**7000
SERIES**

MultimediaVGA

Genoa
SYSTEMS CORPORATION

**NOW WITH
WINDOWS 3.1
DRIVER**

24-BIT True Color Solutions with Genoa's MultimediaVGA.

The new Genoa MultimediaVGA provides 24-BIT true color solutions at affordable prices. The graphics professional can reach 16 million colors at 640 x 480 and 64,000/32,000 colors at 800 x 600.

Standard 24-Bit drivers include Windows, AutoShade, 3D Studio and more. Of course the MultimediaVGA 7900 comes with our popular FlickerFree™ and Safescan™ technologies.

Also available Genoa's WindowsVGA 8000 series of Window accelerator products. All this and more from your obvious choice in computer graphics...Genoa. For more information call your distributor or nearest dealer today.

Call your distributor or dealer for a demonstration now.



The Ultimate Graphics Solution

Genoa Systems Corporation
75 East Trimble Road
San Jose, CA 95131 USA
Telephone: 1 - 408 - 432 - 9090
Fax: 1 - 408 - 434 - 0997
Genoa BBS: 1 - 408 - 943 - 1231

© 1991 Genoa Systems. All registered and unregistered trademarks are the property of their respective owners. Specifications are subject to change without notice.

Circle 321 on Inquiry Card.



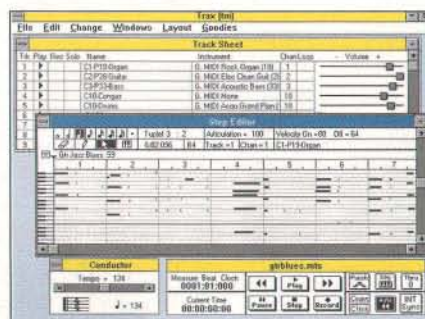

TRAX

\$99
 Passport Designs, Inc.
 100 Stone Pine Rd.
 Half Moon Bay, CA 94019
 (415) 726-0280
Circle 1103 on Inquiry Card.

I am living proof that Passport Designs has created a MIDI recorder and sequencer for nonmusicians. I bought the low-end Trax sequencer because it works with Software Toolworks'

Miracle keyboard, a full-size MIDI keyboard that connects to a PC's serial port. Trax's Miracle drivers let you record from the keyboard and play MIDI recordings through the Miracle's built-in speakers.

At its most basic level of operation, Trax works like a tape recorder. You click on familiar buttons (e.g., play, record, rewind, and fast forward) to record and play back. Trax gives you control of 64 recording tracks. You can select a MIDI instrument by name to record on each track, and you can then play back any combination of tracks. You can insert, delete, or edit notes of individual tracks and can cut and paste blocks of notes or move them around with the mouse. Double-clicking on the note brings up the Edit Note dialog box, where you can numerically set a note's start time, pitch, and duration.

Even if you can't play a lick, Trax is great fun. The program comes with a set of canned pieces that you can edit and rearrange. A real musician will probably opt for the professional version of the program (Master Trax Pro), but novices can do fun and useful work with Trax alone.

—Stanford Diehl



SPEED READER

\$49
 Davidson & Associates, Inc.
 P.O. Box 2961
 Torrance, CA 90509
 (800) 545-7677
Circle 1104 on Inquiry Card.

Since I was a kid, I've wanted to read like Bookworm on the *Batman* TV series—almost as fast as I could flip the pages. At last, with Speed Reader from Davidson, I'm on my way. The program, which aims to double or triple your reading speed, preaches the method of reading groups of words instead of plodding along a word at a time.

After assessing your current reading speed and comprehension, the package tries to increase your peripheral vision so that you can read several words at once. The program provides a series of warm-up exercises to get your eyes ready for speedy reading. You fix your vision on a black dot displayed on-screen; then a group of words flash on. By keeping your eyes trained on the focal point, you must rely on your peripheral vision to see the groups of words. There's also a group of eye games designed to broaden your range of vision.

Another component of the program scans through a selected passage of text, highlighting word groups. This not only forces you to read at a programmed pace, it also trains you to read words in groups. After displaying the passage, the program asks some multiple-choice questions to test your comprehension.

This is a fun program with a noble goal. Anyone can become more productive by increasing reading speed and comprehension. The reading selections are a bit dry—they're reminiscent of the aptitude tests we all took in grade school—but you can import your own selections or even read from a book while the program times you. With its professional software design and proven training philosophy, Speed Reader should sharpen your reading skills in no time. ■

—Stanford Diehl



We're Up on Touch

All operating systems mentioned are trademarks of their respective manufacturers.



You can have your mouse-driven application up and running with touch input instantly, using one of our TouchMonitors and software for Windows, OS/2, MS-DOS, or Macintosh environments. We offer two types of touchscreen technologies, the largest selection of components and development tools, and expert assistance. It's easy to get your application up and

running on touch. Just call the touchscreen company.

Elographics, Inc.
 105 Randolph Road
 Oak Ridge, TN 37830
 615-482-4100

ELOGRAPHICS
 the touchscreen company

Circle 57 on Inquiry Card.

You want a high quality file server with outstanding performance, compatibility and expandability. So...

Make Northgate® Elegance™ 486/33 EISA The Heart Of Your LAN!

How good is Northgate Elegance 486/33e?

Here's how *PC Magazine** summed it up:

"The Northgate Elegance 433e is a turnkey NetWare® computer with a laudable price..."

"It's not just the eight bays that make this machine special. A hard disk controller designed specifically to work with NetWare®, plenty of memory- and board-expansions capacity; a hefty, cool and quiet power supply; and Northgate's focus on network-specific support all make the Elegance an excellent choice as a Novell® file server."

"...Northgate gives network administrators everything they need - a turnkey system with hard disks optimized for NetWare, excellent expansion capability and good performance..."

"...Northgate preconfigures every Elegance 433e to each network administrator's needs. Plug it in and it works."

"The Northgate Elegance 433e, with its well-rounded and sensible configuration, has it all; a performance/features score that's better than average and a dynamite price which together create a higher-than-average Bang for the Buck score. The server is even Novell certified."



PC
MAGAZINE
EDITORS'
CHOICE

March 17, 1992
Northgate
Elegance 433e

PC
MAGAZINE

10 Presentation Programs to Help You Get Your Point Across

FREE UTILITY
WINPTR Makes Your Cursor Stand Out In Windows

COMMUNICATIONS
Fast, Fast Modems: We Test 10 That Communicate at 14,400 bps and Better

SERVER POWER

PC Labs Tests 22 486/33 Machines That Can Drive Your Business

SPEED UP WINDOWS!

13 Graphics Accelerators Run It Up to 10 Times as Fast

Turn the page for all the benefits of owning a Northgate LAN solution...

At Last! Hassle-free Turn-Key LAN Solution

Northgate® recognized your need for LAN systems that save you time, money and aggravation. That's why we pioneered the direct sales of full-service LAN solutions. Now, it's incredibly easy to give your business networking efficiencies, because we do it all from the installation of networking hardware and software to service and support.

The foundation of a Northgate LAN is award-winning hardware—including the incredible Elegance™ 486/33 EISA file server, recently selected as *PC Magazine's* "Editors' Choice." Northgate's full range of performance-engineered products allows our LAN experts to custom design your LAN complete with installed networking cards and software, to meet your broadest business applications.

High Performance Networks For Up To Hundreds Of Users.

Whether you need an entry level network for as few as four users or a complex LAN with hundreds of workstations, Northgate has an industry-standard solution that's second to none. Take a look at everything Northgate offers:

Powerful File Servers and Workstations. Northgate offers file servers ranging from our 386/33 to our 486/33 EISA systems. And, all are FCC Class B certified. Northgate also offers you a complete range of workstations, featuring our popular 386SX™/20 systems.

Choice of Topologies. Northgate offers a variety of topologies to meet your applications. Select from ARCNET, ETHERNET Thin Net, or ETHERNET 10BASE-T. Token Ring products also available.

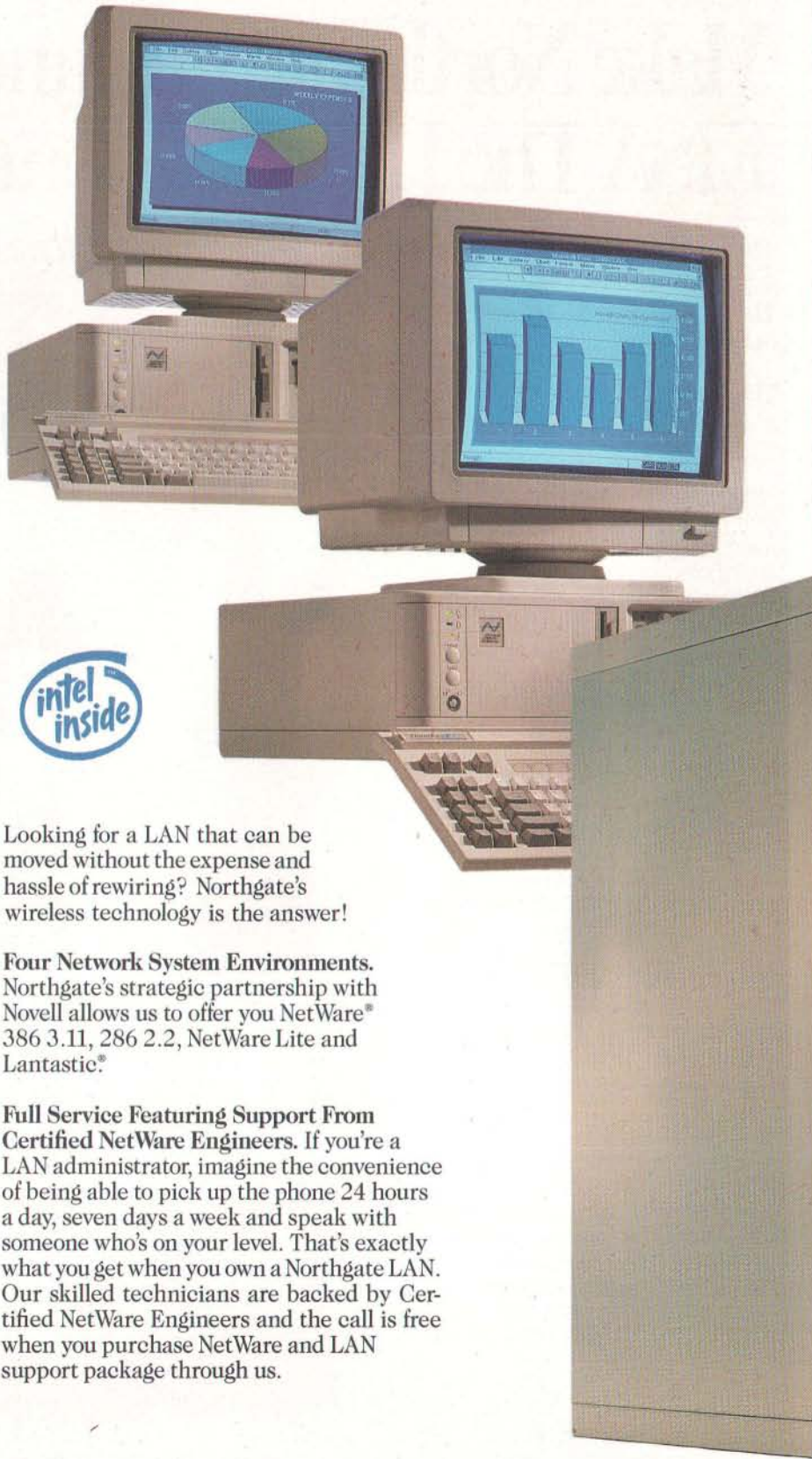

Looking for a LAN that can be moved without the expense and hassle of rewiring? Northgate's wireless technology is the answer!

Four Network System Environments. Northgate's strategic partnership with Novell allows us to offer you NetWare® 386 3.11, 286 2.2, NetWare Lite and Lantastic®.

Full Service Featuring Support From Certified NetWare Engineers. If you're a LAN administrator, imagine the convenience of being able to pick up the phone 24 hours a day, seven days a week and speak with someone who's on your level. That's exactly what you get when you own a Northgate LAN. Our skilled technicians are backed by Certified NetWare Engineers and the call is free when you purchase NetWare and LAN support package through us.

Backed By Certified NetWare® Engineers.



"Editors' Choice" Elegance 486 EISA Configuration:

- Intel® 80486/33MHz processor
- 32MB of 80ns RAM
- 128K SRAM memory cache; read/write-back caching
- 676MB SCSI 16ms hard drive
- Ciprico Rimfire 5600 SCSI controller
- EISA bus with eight 32-bit expansion slots: six bus master; two slave
- 1.2MB 5.25" and 1.44MB 3.5" floppy drives
- Weitek® 4167 math coprocessor support
- One serial, one parallel and one PS/2® style mouse port
- 300 watt power supply with dual recirculation fans
- Eight bay upright Tower case; room for eight external half-height devices
- OmniKey® keyboard
- 14" monochrome monitor with 720 x 348 video card
- MS-DOS 5.0
- Microsoft® Windows™ and mouse
- DiagSoft™ QA Plus™ diagnostic/performance software
- One year limited warranty on system parts and labor; five years on keyboard
- On-site hardware service provided by NCR®
- FCC Class B Certified
- Novell Certified

"Editors' Choice" Elegance 486/33 EISA Configuration \$7399

Lease as low as \$248.05 per month**

Other Configurations Starting At: \$3649

Call For LAN Pricing And Custom
Configuration Information
800-345-8709

Major corporations, volume purchasers and government agencies call National Business Accounts: 800-545-6059
GSA# GS00K91AGS5193 PS01
Keyboard Sales: 800-526-2446
Charge it to your VISA, MasterCard, Discover, American Express or Northgate Big 'N' Card.



7075 Flying Cloud Drive, Eden Prairie, MN 55344

Look at all the other Northgate extras. You also receive free non-diagnostic on-site hardware service from NCR® for one year. As well as a limited one year parts and labor warranty and overnight shipment of replacement parts at our expense. Customized service and support packages – including extended warranty coverage – are also available.

To discover all the advantages of a networking solution from Northgate, call us toll free, today.

CODE B3906

EIS MOVES TO THE DESKTOP

Executive information systems help you identify key business trends, data relationships, and exceptions

A new crop of Windows-based products allows you to view, analyze, and report on vital business data existing in a variety of formats, from IBM's DB2 in the mainframe's data bank, to Oracle on the department's file server, to Lotus 1-2-3 on your PC's hard disk. These products are called executive information systems.

An analogy to an EIS would be the Sunday newspaper section that focuses on the events of the past week. This section pulls together stories from a variety of sources, makes them understandable, and provides underlying news analysis. An EIS provides similar benefits to company managers at all levels by providing software tools that retrieve company data from many sources (mainframe, minicomputer, LAN servers, and local PCs) and present this data clearly. Unlike the static newspaper, however, EISes let you scan the data headlines, selectively "drill down" (in hypertext fashion) on a headline to see more information, combine this data with other data, and make more informed decisions based on data that is constantly being updated.

Originally intended to replace inch-thick paper reports, EISes were first designed as specialized mainframe applications, with costs starting at \$100,000. But the explosive growth of PC LANs has radically altered the EIS landscape. The new realities of the marketplace have challenged the efforts of traditional EIS suppliers to keep pace.

The three products reviewed here have different roots. PowerPlay 2.0 from Cognos and Lightship 3.01 from Pilot Software came from mainframe- and minicomputer-based companies; Forest and Trees for Windows 2.0 from Channel Computing was designed by a company specializing in PC-based solutions.

While EISes may appear to package information simplistically, the fact is that a colorful, graphical environment helps you not only to better understand the data but also to convince others of your point of view. So it's not surprising that all three products run under Microsoft Windows.

Getting Started

Deciding to go to EISes is not a sudden decision for most companies. Instead, it is a growing corporate-wide understanding that managers need specialized data quickly and presented in a



clear, easily adjustable format. For example, a sales manager wants to be able to see data by channel and by product. Unwilling to wade through the swamp of printed reports, the manager wants to get to the bottom line as quickly as possible. In a competitive business environment, it's imperative to be able to quickly identify key business trends, data relationships, and exceptions to your plan. (See the text box "EIS in the Real World" on page 210.)

Once the need is identified, other fundamental requirements for the success of an EIS include

- identifying an individual who has a thorough familiarity with the company's data assets;
- gaining the interest, attention, and creativity of the organization that will use the system;
- management's committing to the project's success as well as to its ongoing maintenance; and

- devoting programmers to design and create the user-specific application.

First Looks

A lot of tools let you simply retrieve the data that resides on a variety of platforms in different formats. For the purposes of this review, however, I have defined an EIS as having specific capabilities: It can

- perform data retrieval across a wide range of platforms and data formats;
- analyze data in a variety of ways;
- graphically present the information;
- create ad hoc reports; and
- contain customized application-development tools to build an application that automatically performs routine tasks.

All three of the reviewed products provide simple data access, and none has the ability to change data at its source. Each retrieves the data that it works with in a fundamentally different way—a factor that you should consider carefully when you determine whether a program's data model meets your system's goals.

PowerPlay (see screen 1) is especially different from its counterparts, since you develop a specialized database using the PowerPlay Creator tool. Using two input files—a summarized data (.DAT) file and a definition (.DEF) file—the program extracts data elements from a variety of files and locations. It can extract virtually any file format as long as you can convert the file to a flat ASCII file format (this could include DB2, Oracle, or Lotus 1-2-3 files).

The resulting data extract, or "bucket of information," from PowerPlay lets you explore the data from any perspective and perform searches with predictable response times. It lets you download this extract on as regular a basis as is practical, but it provides no links to the original data sources.

Since there are no live links, the PowerPlay method is not recommended if you need to work with up-to-the-minute information or if the extract may not contain

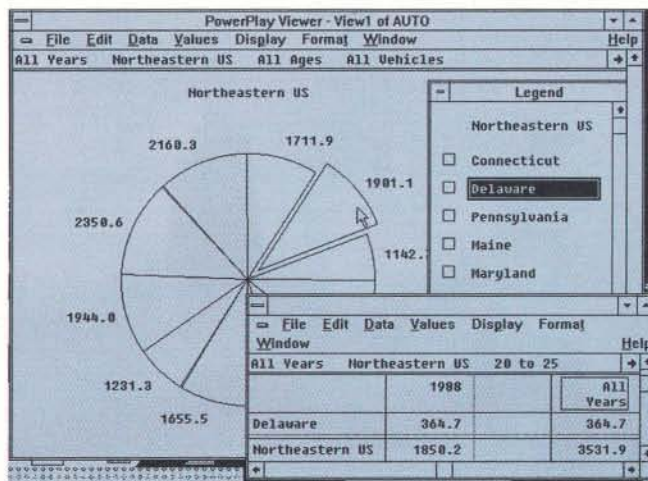

Screen 1: PowerPlay extracts data from a variety of files and locations and deposits the information in a specialized user database.

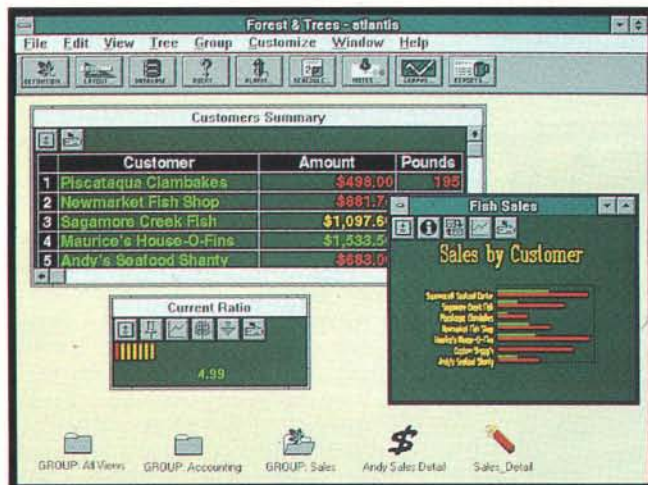

Screen 2: Designed to run like an electronic dashboard monitoring company data, Forest and Trees alerts you when certain predefined data conditions exist.

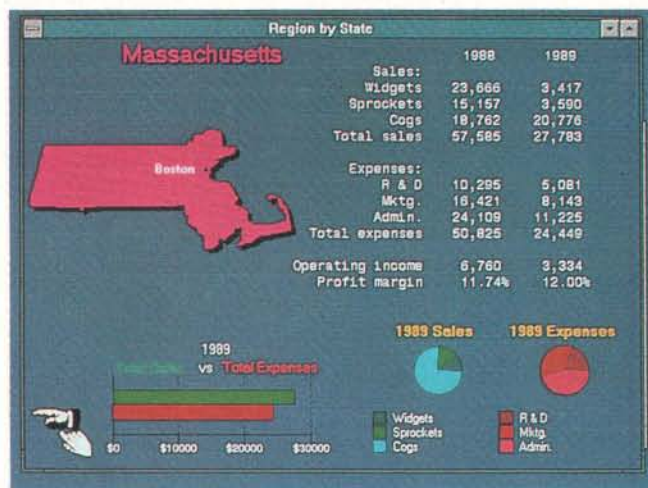

Screen 3: Lightship provides a comprehensive range of file and network support to live data.

all the information you're likely to need to query. Rather, the PowerPlay model is ideally suited for organizations whose data is updated on a weekly or monthly basis. With this product, you can eliminate many

thorny issues associated with on-line data access, such as who has the rights to access production files and how live data links may degrade network performance.

Forest and Trees' data-access method

Girl Scouts Care for the Earth



Girl Scouts have a tradition of caring for the earth. For 80 years we've been recycling, planting trees and cleaning beaches.

This year, millions of Girl Scouts nationwide are working to help care for our environment.

Won't you join us? Call your local Girl Scout council to find out how.



WINDOWS/EIS MOVES TO THE DESKTOP

EXECUTIVE INFORMATION SYSTEMS COMPARED

A variety of different features and data types supported highlight these EISes.

	Forest and Trees for Windows 2.0	Lightship 3.01	PowerPlay 2.0
Price	\$495	\$750	\$850
Technical support	1 year free; toll-free number	90 days free; toll line	\$130 per year; toll-free number
DDE support	Yes	Yes	No
Data providers			
Standard	1-2-3, Excel, dBase, R:Base, Paradox, DataEase, Q&A, Btrieve, ASCII flat files	DDE links	Any ASCII flat file
Optional	SQL Server, Oracle, Gupta SQLBase, Novell NetWare SQL, Teradata, IBM AS/400 and DB2	With Lightship Lens: dBase, Paradox, Oracle, SQL Server, Sybase, DB2, Novell NetWare SQL, text files	None
Platforms supported	Windows, DOS	Windows	Windows, Macintosh
On-screen alarms	Yes	No	No
Data model	Live links	Live links	Extracted data bucket

is 180 degrees from PowerPlay's. Channel Computing's corporate mission is to help you find your data and access it where it lives. Thus, all the data links are with live data. Designed to run like an electronic dashboard monitoring your company's data, Forest and Trees (see screen 2) runs as a background task to alert you when certain predefined data conditions exist.

Forest and Trees comes standard with data providers for common data formats, such as Lotus 1-2-3, Microsoft Excel, Borland dBase, Borland Paradox, and ASCII (see the table for a complete list). Optional data-provider links are also available for Microsoft SQL Server, Oracle, Gupta SQLBase, Novell NetWare SQL, and IBM AS/400 and DB2 formats.

Setting up data-provider links is the task of the application builder. As difficult as it might seem to do this, Forest and Trees relieves most of the connection pain. To establish the connection, you open the database view, identify the location of the file, and fill in the necessary information about the appropriate log-in procedure and password protection.

Like Forest and Trees, Lightship (see screen 3) constructs live links to data, but its data gateway is different. The base version of Lightship relies solely on the DDE protocol of the Windows 3.x environment.

Since this method is limited to accessing data from other applications that support DDE, such as Excel, Pilot Software has

BYTE ACTION SUMMARY

- **WHAT EXECUTIVE INFORMATION SYSTEMS DO**
EISes collect and analyze company data from many sources (mainframe, minicomputer, LAN servers, and local PCs) and present it in an easily understandable way.
- **LIKES**
EISes let you scan the data headlines and then selectively drill down on a headline to see more information.
- **DISLIKES**
Lightship's use of DDE is more restrictive than it may seem; to date, few applications have full support for DDE.
- **RECOMMENDATIONS**
If you need live data links, Forest and Trees provides the widest and most versatile range of data support. It's also the least expensive of the reviewed products.



Haunted By Project Management Nightmares?

Screaming users. Missed deadlines. Escalating budgets. Incompatible hardware. Resource conflicts. Fuming VPs. It's the stuff nightmares are made of.

Coordinating projects with thousands of tasks and dozens of users across multiple platforms can turn into a bad dream — unless you have *Artemis Prestige for Windows* from Lucas Management Systems.

Because it runs under Microsoft Windows, *Artemis Prestige* speeds up and simplifies project planning, reporting, and updating. *Artemis Prestige for Windows* is the first project management tool to take advantage of **client/server architecture** — simultaneously lowering your CPU costs while boosting your LAN's productivity.

If your worst nightmares are coming true everyday, try *Artemis Prestige for Windows*. It'll make your job so easy it's scary. For more information, call 1-800-4-PRO-MGT.

Artemis
PRESTIGE

THE ONLY TRUE MULTI-USER, MULTI-PLATFORM,
MULTI-PROJECT MANAGEMENT SOFTWARE.

Lucas Management Systems

EIS in the Real World

In contrast to the earlier generation of mainframe-based executive information systems, today's EISes have been designed to work in a decentralized mode, with the desktop PC as the primary analytical engine. Despite these advances, EIS success stories are still the result of pioneering efforts by those who can see the bottom-line benefits.

In many ways, EIS successes are more difficult to achieve today than ever before. Many companies now have data distributed over many different databases, locations, and hardware platforms. Pulling it all together into a coherent whole requires coordination at many levels, but the rewards can be worth it, according to those who have made the effort.

Texas Instruments

With Lightship, the TI (Texas Instruments) plant-automation facility in Hunt Valley, Maryland, has been able to switch from damage reporting to damage control. Before TI implemented Lightship, information was spread around in a variety of reports, and it was difficult to anticipate problems. With the EIS, managers and engineers at many levels (e.g., cost center, project, and site managers, and chemical and hardware engineers) can control spending on both internal and R&D projects.

The main office used to run a series of damage reports to find out what had gone wrong when costs for the process-automation systems were out of line. But since the reports were run after the fact, it was too late to do anything to fix the problems. Now, with Lightship, the managers can control and track costs as they occur, and they can perform damage control in real time by exploring regularly updated project information.

Using a hot spot on the screen (i.e., an area that has been programmed to perform other actions when you click on it), managers can "drill down" (in hypertext fashion) from the project level to the actual cost elements and compare budgeted dollars to actual costs as they occur. Thus, they can see not just

how much money is left in a certain budget but whether or not the money is going too fast.

Lightship interfaces with an Oracle database on a DEC VAX system, a local inventory system, and IBM mainframes in TI's Dallas, Texas, facility. The EIS uses a DEC PathWorks network and 386s running Windows. (The Hunt Val-

Despite advances, EIS success stories are the result of individual efforts.

ley plant changed to Windows for Lightship; programmers with no Windows and little SQL [Structured Query Language] experience performed the implementation.) Lightship Lens was not available at the time of installation, so the plant used Q&E, which performs the necessary functions; the company has seen no reason to switch over.

TI considered several packages before making its choice. Forest and Trees has a hierarchical tree structure and didn't allow the kind of "slicing and dicing" that TI needed. PowerPlay required detailed data definitions, while Lightship does not. TI is pleased with its choice of Lightship, but the company is aware that current versions of the other products may no longer have the difficulties it found when evaluating them.

The only real problem TI has run into with Lightship has been with performance—a subjective problem, in this case. Most of the performance problems have been linked to variances in the network. But for some users, the 5- to 8-second response time for an EIS

report request seems slow. TI was quick to point out, however, that in the past such reports would have taken days to compile.

As for a wish list of changes or new features, the only prominent item on it would be a completely ad hoc query tool. SQL, it seems, has some limitations. For one thing, it can't do cumulative adds, and TI would find that ability helpful. Instead, people work around the constraint with Q&E.

The change from damage reporting to damage control that Lightship made possible is one of taking control of your information. It is the difference between acting and reacting.

Dr Pepper

The Dr Pepper/7Up Companies use PowerPlay to give upper management access to sales and demographic data at the company's corporate headquarters, located in Dallas, Texas. The EIS accesses relational database files residing on several VAX machines from DEC. PowerPlay runs on PC compatibles on a Novell network.

Dr Pepper uses PowerPlay to generate monthly, yearly, and package reports for its field-sales executives—reports that replace headquarters-generated paper reports. PowerPlay's extracted database is updated monthly and then downloaded from a VAX to the regional PCs. This monthly extract allows the field-sales offices to evaluate the sales performance of local bottlers. Since the extracted regional data files are less than 2 MB in size, the local office can optionally load the data onto a portable PC to graphically review and report the data at the customer site.

While PowerPlay does not contain live data links, Cognos has a package that Dr Pepper uses, called Database Host Connector, that provides some of that functionality. With PowerPlay, Dr Pepper sales executives can complete most reporting functions in the field. The program has also eliminated a considerable amount of rekeying of information.

Dr Pepper has no problem with the response time for the system, but the

company would like to see some improvements in the product. One such improvement would be to fully automate the process of definition file automation. Another would be to add triggers or alarms to PowerPlay to indicate when certain exception conditions occur.

On the whole, however, Dr Pepper is very pleased with PowerPlay. The product has proved to be a timesaving, flexible aid to decision making.

Heidelberg Harris

Formerly called Harris Graphics, Heidelberg Harris's Webb printing-press plant in Dover, New Hampshire, was an original beta-test site some years ago for Forest and Trees. The EIS accesses a Novell NetWare network of 800 clients and 50 servers, plus an NCR 9800 and 80 Hewlett-Packard 9000s running Unix on a WAN (wide-area network).

The company uses Forest and Trees for a wide range of corporate applications that require the use of live data links. One of them, which Heidelberg Harris calls Cop on the Block, monitors the status of orders in the manufacturing process. Job-related data is "swiped" through magnetic card readers and entered into an Oracle database that Forest and Trees accesses.

Cop on the Block enables top-level and operations managers to obtain financial, factory, and attendance information through database querying and reporting on information such as budgeted costs versus actual costs and other accounting information. Forest and Trees' alarm capabilities provide exception notification. For example, Heidelberg Harris has one alarm set to notify managers when any of their employees are more than 1 hour late to work.

The EIS project coincided with the firm's efforts to downsize its mainframe applications to those built around PCs and networks—a client/server distributed environment. Forest and Trees enables Heidelberg Harris to insulate its users from the change by maintaining a single view on the data while the machines change. Be-

cause Forest and Trees can access so many different file types to obtain information, you never even know that the underlying hardware is different—the view that you see remains the same.

In addition, since queries are easy to formulate under Forest and Trees, the users can take over this function from the MIS department, after a period of adjustment. Then, when the MIS department develops new applications, it has less work to do. It only needs to write the transaction-processing functions; the users then write their own queries.

Heidelberg Harris has had a few minor problems with Forest and Trees. They amount more to suggestions for future improvements than to actual complaints.

The average response time for a query is not a problem. For example, a query of 3200 records that joined four tables required just 17 seconds to complete. Response time becomes a problem only when someone requests an "order by" index for a nonexistent index. Then the system must check some 200,000 records, and the response is so poor that the terminal locks up for about half an hour. You can reboot to free the terminal, but the transaction continues to process in the system, consuming processor time. Notification that the index requested does not exist would be in order.

Another minor problem exists with the Query Assist function: It doesn't handle complicated data names (e.g., multipart hyphenated data names) well. They may be rejected, requiring manual alterations, such as the insertion of quotes.

In the way of a wish list, Heidelberg Harris thinks that it would be more efficient if Forest and Trees did its sorting at the client system, not at the server. This change would provide more flexibility in setting up reports (you could decide on the sort order after you see what the data looks like) and would save bandwidth, since you wouldn't have to request multiple transmissions of data for different sort orders.

developed a Lightship add-on called Lightship Lens to provide access to popular file types like dBase, Paradox, SQL Server, and DB2. Lightship Lens passes information back and forth from these files to Lightship with the DDE protocol or through DLLs.

Using DDE has advantages and disadvantages: You will like the automatic update of information from one application to another; but for the DDE connection to work, all the applications must be memory-resident. And the simple reality remains that few applications fully support the DDE protocol.

Each of the reviewed programs has selected substantially different approaches to building and accessing data for analytical use. If you don't require live data links, the PowerPlay extracted data bucket may be the most flexible model, since it has the extra benefit of providing predictable response times from a data extract that could come from a variety of data formats. But this approach also tends to isolate you from the actual data source, so it comes as no surprise that Cognos has announced a new product, called Impromptu, to provide SQL (Structured Query Language) links to live data.

If your company requires live links to data or wants to make ad hoc inquiries to a wider universe of data, then Forest and Trees provides the widest range of data support in its base package. Lightship, however, bolstered by Lightship Lens, also provides a comprehensive range of file and network support to live data.

Explorative vs. Predictive

While data access is a fundamental design item for the system implementer, a program's ability to present, analyze, monitor, and report on the data is what differentiates its functionality for you. With an EIS, you typically begin by looking at a summarized big-picture view of the data, such as sales volume by all products, and then drill down to more detailed data items, such as sales by product by state by channel.

PowerPlay's strength lies in its ability to "slice and dice" information in myriad ways. However, since you must explore the data and perform all of the data analysis, the program's benefits are limited to your skill and intuition. To its credit, PowerPlay's user interface is cleanly defined, and its concise, colorful documentation overcomes the fears of even the most uninitiated.

As you navigate the data, PowerPlay's pointing cursor changes to a cross when it's over a data element that you can drill down on to inspect more detailed levels. You can alter the data view with a simple

menu command. For example, if you want to see syrup sales by region in a stacked bar graph (or six other graph types), you click on the menu item; if you want to change the data to a crosstab view, you click on that menu item—you can even swap the rows and columns. If you prefer percentages to sales numbers, you select that menu command. When you finish with the data analysis, you can use a similarly flexible reporting tool to create a range of reports.

Monitoring Live Links

Typically, to build a Forest and Trees application, some familiarity with SQL and networks helps. You must define specific queries that result from studying and evaluating the system. The result of each query is a *screen view*, the basic element of Forest and Trees. The view can contain a single value (e.g., total inventory), a list of values (e.g., top 10 salespeople), or a graph (e.g., the top-selling products by sales volume). You must define the data conditions that will trigger certain alarms, who should have access and to which data views, the way to display the data, and how often to query the data to ensure that it is current.

You can create a prototype Forest and

Trees application in a matter of days using SQL statements. If you don't know SQL, the program provides substantial help—a Query Assist function lets you simply pick the function and data elements and even test the query to ensure that the expected value is returned. For example, to define a screen view that would order sales representatives by sales dollar performance, the query might look like this:

```
"SELECT SALESNME, TOTSALES,
FROM CMPSALES, ORDER BY
TOTSALES"
```

Forest and Trees excels with applications that need to monitor data closely and set alarms for exceptions. Neither of the other programs comes close to its electronic-dashboard monitoring features. In addition, it can augment its preprogrammed applications by submitting ad hoc SQL queries against the live database.

On the downside, however, ad hoc SQL queries can be prone to problems. Sending a poorly constructed query against live data files can degrade the server's performance while locking you out from doing any other work until it completes.

Emphasis on Graphics

Lightship also links queries to live data sources. It relies on DDE to access its data, or on an intermediary link, such as Lightship Lens or Q&E (a software program from Pioneer Software, Raleigh, NC), to provide the DDE passageway for standard data sources.

The cornerstone of Lightship is its highly graphical environment, superior to both PowerPlay's and Forest and Trees'. With a modest amount of work, you can design brilliant Lightship applications. You begin with a blank screen and manipulate objects on it to create the look you want. You can shape and size text, graphics, and data into each of the designed objects. You can even incorporate images (.BMP and .PCX) onto the screen for applications ranging from human resources' photo of an employee to the map of a sales territory.

An area of the screen can also define a menu or a *hot spot* (an area of the screen programmed to perform other actions when you click on it, as with a macro). To detect hot spots, you must look for the radio buttons on the screen or notice when the cursor changes from a pointing device to a pointing finger.

THE BEST WINDOWS ALL-IN-ONE CONFIGURATION

TROUBLESHOOTING/ANALYSIS TOOL FOR THE PC

WINSLEUTH™ PROFESSIONAL



WinSleuth Pro Title Screen

screen displays information on each system under examination. Simply click on an area of interest to reveal more information.

Version 2.0 shatters the Windows barrier to allow the user to penetrate down to the hardware level for analysis and hardware testing and reporting—new capabilities no other diagnostic software can match!

Users may now actively test such hardware as the

WinSleuth Professional (version 2.0) is the completely new edition of WinSleuth designed for professional diagnostics / analysis of Windows applications for the PC.

A computer graphic



Keyboard Diagnostics

video subsystem, keyboard, serial and parallel ports, the mouse, disk drives and even memory on the motherboard—all without leaving the Windows environment.

In addition, version 2.0 enables the user to analyze DOS level information, including TSR usage, Device Driver, Memory Address and Input/Output port usage—again without leaving Windows and when multitasking. Get the information you need on memory, disk drive usage and data on Conventional, Extended, Expanded AND Windows DPMI memory management.

Installation Assistant helps make the installation of new hardware and easier than ever before.



One Megabyte Map

Order NOW and get CO/Session-- the award-winning remote control program

WinSleuth (\$169.00) AND CO/Session (\$195.00)



COMPUCLASSICS
YOUR SOURCE FOR SOFTWARE

ONLY
\$99!

800-827-1994/818-347-7500/FAX 818-347-997

See the Difference.

INFO
WORLD
ranks Nanao #1

"Using each adapter at VGA, 800-by-600 and 1,024-by-768 pixel resolutions, all test images were displayed crisply."

-- PC Week



"The image is the brightest we've ever seen, even in the brightly-sunlit new CADalyst office."

-- CADalyst



"The intelligence built into this monitor eliminates all of the arm stretching and wheel turning so often associated with video mode changes."

-- PC Magazine

"Nanao thoughtfully places the seven most-used controls on the front of the monitor, unobtrusively tucked below the faceplate."

-- Macworld

See the difference that the industry experts agree has set the **Nanao Flexscan 9080i** apart from other monitors.

The Difference Will Impress You.

Color yourself impressed by the Nanao Flexscan 9080i's multiscanning abilities and high resolution. The 1280 x 1024 non-interlaced resolution increases productivity and enhances graphics applications beyond compare. Its high refresh rate (74Hz) is easy on the eyes. And with sharper text and brighter colors, the 9080i delivers the high quality professionals need...and want!

The Difference Will Excite You.

Get excited about doing what you've always wanted to do with Windows on the 9080i's larger 16-inch screen area. Highly compatible, in compliance with the Video Electronics Standards Association. Convergence & pin-cushioning controls. Dual inputs for two computers or two boards. The little differences that make for an exciting new monitor.



The Difference Will Comfort You.

Sometimes for high performance you need to give up creature comforts. But not with the 9080i. Sit back and relax in front of your Nanao monitor and its convenient front control panel. Almost every adjustment is within your reach. Nanao Flexscan monitors even align themselves with the Swedish MPR standards of low radiation emissions and give you an anti-static coating, fulfilling your ergonomic needs.

See the family of monitors ready for the next step in high resolution. To see the difference for yourself, contact your local Nanao dealer or call us at **1-800-800-5202**.

NANAO®

NANAO U.S.A. CORPORATION
23535 Telo Avenue
Torrance, California 90505
(213) 325-5202

Circle 31 on Inquiry Card
(RESELLERS: 32).

With Lightship, hot spots aren't hard-wired. They are data-driven, so, as you click on a hot spot, it can perform the same task that a menu item might otherwise do, or perhaps perform some mathematical function. For example, you might be able to drill down from an image of the East Coast region to the East Coast sales figures by product line, and then again to the sales by state.

While Lightship's application development is not difficult, it requires substan-

tial up-front effort, defining how the application should look and operate. Lightship provides object-oriented drawing tools for creating the screens and objects.

Pilot Software encourages building applications with a minimum number of graphical screens—Lightship applications are simply a series of .LSFs, or Lightship Screen Files, that have data connections with one another. This economical approach allows you to flexibly add people or departments or to change sales regions

with little or no modifications to the original design.

Which One Is Best?

Choosing the program that best suits your needs requires careful planning and evaluation. It is impossible to recommend one package over another without knowing the requirements of a specific installation. PowerPlay gives you great flexibility in exploring an extracted bucket of information. Forest and Trees monitors corporate data like an electronic dashboard and alerts you when certain conditions or exceptions of your choosing exist. And Lightship's highly graphical front end lets you click on hot spots to see underlying data and relationships.

When you complete your evaluation, start small and provide enough time to do a prototype of the initial application. New and creative needs will evolve quickly as you begin to use the program. Expecting to make all the right choices the first time you run it is unrealistic; a successful EIS installation is the end result of an iterative process. However, using an EIS promises to significantly alter the way you look at data, how you work, and how you compete in the 1990s. ■

Jim Kinlan is a PC software marketing consultant living in Concord, Massachusetts. You can reach him on BIX c/o "editors."

COMPANY INFORMATION

Channel Computing, Inc.

(Forest and Trees for Windows 2.0)
53 Main St.
Newmarket, NH 03857
(800) 289-0053
(603) 659-2832
fax: (603) 659-7590

Circle 1075 on Inquiry Card.

Cognos Corp.

(PowerPlay 2.0, Impromptu 1.0)
67 South Bedford St.
Burlington, MA 01803
(617) 229-6600
fax: (617) 229-1839

Circle 1076 on Inquiry Card.

Pilot Software

(Lightship 3.01, Lightship Lens 3.01)
40 Broad St.
Boston, MA 02109
(617) 350-7035
fax: (617) 350-7118

Circle 1077 on Inquiry Card.

PGC CASE Graphics Made Simple

Step 1: Select Tools and Objects to draw your design

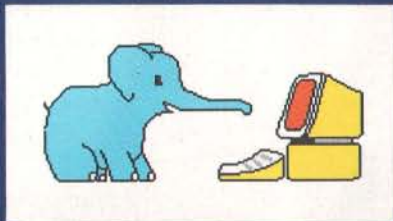

Data Flow Diagram
Structure Chart
Object-Oriented Analysis
(E-R Diagram)
Data Structure Diagram
Flow Chart
Window Layout
Presentation Graph

Step 2: Link your design any way you want

Step 3: Change your design by clicking the symbol,
each movement is displayed

Step 4: Flip your designs on the screen like a
story board

Available from dealers or directly from the Company:
Pacific Gold Coast, Corp.
15 Glen Street, Glen Cove, NY 11542
(800) 732-3002 / (516) 759-3011
or fax (516) 759-3014



Introductory Price: \$129
Major Credit Cards Accepted



System Architect kicks into overdrive: Today's Price/Performance CASE Leader Now Offers Schema Generation.

Now you can build applications even faster with System Architect's new database Schema Generator. And System Architect is so easy to use, even beginners will be productive in no time.

NEW: Schema Generator.

Translate entity models, captured in our encyclopedia, into schema for DB2, Oracle, INGRES, SQL Server, RDB, Progress, Paradox, SQL Base, AS400 (SQL), XDB, Sybase, and Informix. Generate data definitions for C or COBOL programs. And create Windows user dialogue panels.

NEW: Screen Painter. (Call for availability.)

Develop screens for Windows, Presentation Manager, or character-based applications. The screens you create are then linked to our encyclopedia.

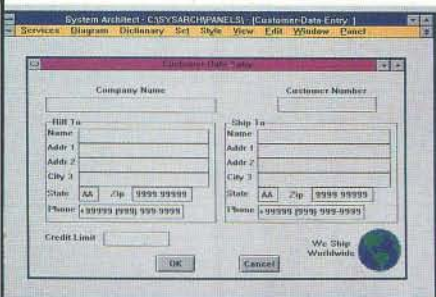

Multiple GUI screens.

Multiple Methodology Support.

Work with such methodologies as Demarco/Yourdon, Gane & Sarson, Ward & Mellor (real-time), Entity Relation diagrams, Decomposition diagrams, Object Oriented Design (optional), State Transition diagrams, Flow Charts and SSADM.

Integrated Data Dictionary/ Encyclopedia.

Customize your own data dictionary/encyclopedia, and get multi-user support with and without a network.

Advanced Features.

Take advantage of normalization, rules & balancing, requirements traceability, a network version, import/export capabilities, custom reporting, an extendable data dictionary, auto leveling, CRUD Matrices, and automated documentation (enhanced 2167A -- call for availability).

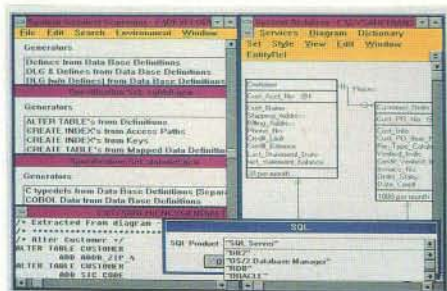

Generate schema from entity diagrams.

A Proven CASE Product.

IEEE Software Magazine called System Architect "a useful, well-planned, affordable CASE tool." CASE Trends found System Architect "to be extremely easy to use... with many features that are completely lacking in higher priced competitors." Toshiba said "System Architect stood out from many other prospects." And System Builder

called System Architect "truly a price/performance leader."

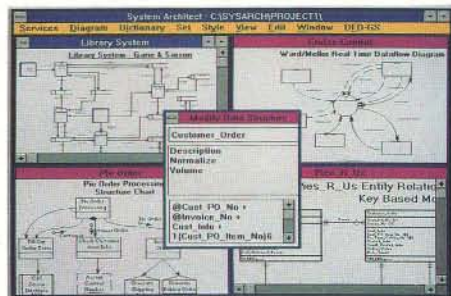

View data models, DFDs, and structure charts simultaneously.

Works under Windows 3 or OS/2 Presentation Manager.

You get full functionality in each environment.

Affordable.

System Architect costs from one half to one fifth the price of comparable CASE products.

**FOR THE REAL-WORLD
CASE SOLUTION, CALL
(212) 571-3434 TODAY.***

POPKIN
Software & Systems Inc.
11 Park Place, NY, NY 10007
Tel: (212) 571-3434
Fax: (212) 571-3436

**MICROSOFT
WINDOWS**
Version 3.0 Compatible Product



Supporting IBM's AD/Cycle

System Architect logo is a trademark of Popkin Software & Systems Incorporated. Other product names used herein are for identification purposes only and may be trademarks of their respective companies. Specifications subject to change without notice at the sole discretion of the company. Product delivery subject to availability.

WE'RE ONLINE. AND IN LINE WITH YOUR OBJECTIVES.

BUSINESS WEEK

AEROSPACE DAILY

AIRPORTS

AVIATION DAILY

AVIATION WEEK &
SPACE TECHNOLOGY

BIOTECHNOLOGY NEWSWATCH

BYTE

CHEMICAL ENGINEERING

CLEAN-COAL/SYNFUELS LETTER

COAL WEEK

DATA COMMUNICATIONS

ELECTRIC UTILITY WEEK

ENGINEERING NEWS-RECORD

HAZARDOUS WASTE BUSINESS

INDEPENDENT POWER REPORT

INDUSTRIAL ENERGY BULLETIN

INSIDE ENERGY/
WITH FEDERAL LANDS

INSIDE F.E.R.C.

INSIDE N.R.C.

INTEGRATED WASTE MANAGEMENT

LAN TIMES

NUCLEONICS WEEK

POSTGRADUATE MEDICINE

PLATT'S INTERNATIONAL
PETROCHEMICAL REPORT

PLATT'S OILGRAM NEWS

PLATT'S OILGRAM PRICE REPORT

S&P'S EMERGING & SPECIAL
SITUATIONS

S&P'S REVIEW OF BANKING
& FINANCIAL SERVICES

S&P'S REVIEW OF SECURITIES
& COMMODITIES REGULATION

SECURITIES WEEK

TECH TRANSFER REPORT

UTILITY ENVIRONMENT REPORT

THE WEEKLY OF BUSINESS AVIATION

UNIXWORLD

AND MORE . . .

When you need business information, why not get the total story, instantly! Word for word. The McGraw-Hill Publications Online database gives you just that. Unedited, full-text retrieval (except graphics) of articles exactly as they are published in McGraw-Hill magazines and newsletters.

Now you can get information on companies, people and products on any topic — pertaining to one particular industry, or search the entire McGraw-Hill library (over 35 leading publications online) for diverse editorial perspectives. Only McGraw-Hill, the world's foremost business information publisher, can deliver it all so completely — immediately! McGraw-Hill unabridged.

Access an entire universe of business information. Go online with our line. McGraw-Hill Publications OnLine. For more information, including our latest list of publications, contact Andrea Broadbent at (609) 426-5523. Or fax this coupon to (609) 426-7352.

Or send it to the address below.

Available through Dialog®, Dow Jones News/Retrieval®, NewsNet® and Nexis®.

McGRAW-HILL PUBLICATIONS ONLINE



Princeton-Hightstown Road
Hightstown, NJ 08520 U.S.A.

Please send me the complete 1992 list of your publications online.

BY

Name

Title

Company

Address

City State

Zip/Postal Code Country

Tel.

GO ON LINE WITH OUR LINE.

Your network buy for today's business technology market.

McGraw-Hill TechNet

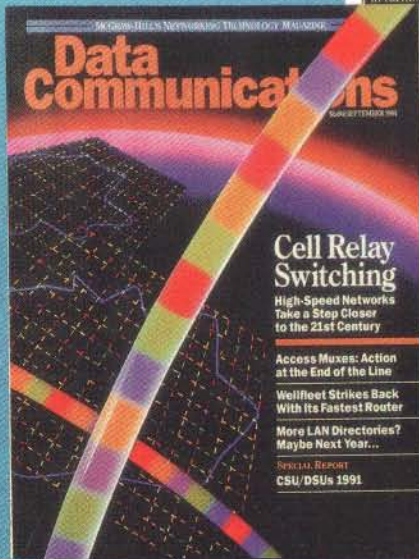
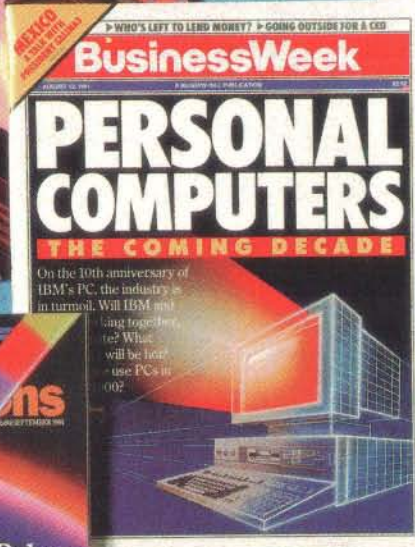

McGraw-Hill Magazines. Your Best Business Partners.

- 4- Architectural Record ■ 7- A/C Flyer, Aviation Week & Space Technology, AW & ST China Quarterly, AW & ST USSR, Business & Commercial Aviation, World Aviation Directory and Buyer's Guide ■ 20- Business Week, Business Week China, Business Week Hungary, Business Week International, Business Week USSR ■ 28- Chemical Engineering ■ 32C- BYTE, Data Communications, Data Communications International, LAN Times, UnixWorld ■ 39-Electrical World ■ 41- ENR, Construction News Publishing Network (11 magazines, 4 newspapers) ■ 46- Global Finance ■ H6- The Physician & Sportsmedicine, Postgraduate Medicine ■ 114- Modern Plastics, Modern Plastics International ■ 117- Power, Power International



Great News For All Window Shoppers.



The new CA line of Windows applications has arrived.

It's the most complete and integrated family of Windows applica-

tions ever developed. Innovative, new technology. And all the latest features and functions. They're easy to learn. Easy to use. And very, very affordable.

There's new **dBFast**.™ The only high-performance database and dBASE/X-
BASE language that's dBASE compatible. It's the fastest and smartest way for millions of dBASE users to join the Windows revolution.

New **CA-Textor**.™ The brand new word processor that adds power to every memo, letter or report you write.

New **CA-Compete!**™ The advanced multidimensional modeling, viewing and forecasting software.

CA-Cricket™ **Image**.™ The award-winning professional image software that gives you complete image conditioning control.

New **CA-Cricket**™ **Paint**.™ The powerful, high-end

painting software for creative and graphic artists.

CA-Cricket™ **Presents**.™ The most persuasive and affordable presentation software ever developed.

CA-Cricket™ **Graph**.™ With a dozen graph types, plus all the color and fonts you'll need.

New **ACCPAC**™ **Simply Accounting**.™ The incredibly easy, entry-level accounting package.

New **CA-SuperProject**™ for Windows. The experienced project manager that gives you the most accurate and efficient project schedules in the industry.

And new **CA-UpToDate**.™ The time and resource management software that keeps track of everything in your company's schedule.

To order your free Demo Disk for any of these new products, dial 1-800-CALL CAI.

Call today. And you'll never have to window shop again.

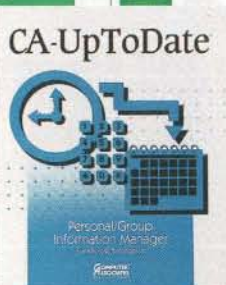
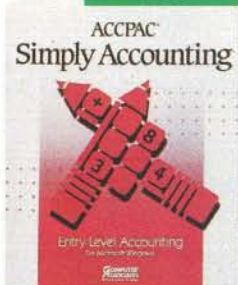

dBFast, CA-SuperProject and CA-Compete! are the three winners of Windows Magazine's "Win Award".



IMAGE MAGIC

Scan, compose, enhance, retouch,
and print color, gray-scale, and black-and-white images

Color bit-map image-editing products for Windows bring some of the sophisticated capabilities of expensive color-prepress workstations to the desktop. While photographers and graphic artists are the primary users of these packages, you can use images prepared with them in desktop publishing, in presentation graphics, and for photographic purposes (see the photos). You can create slides, prints (on a transparent—for overhead projection—or opaque base), negatives, or color separations for four-color printing.

I recently looked at three of these products: PhotoStyler 1.1 from Aldus (Seattle, WA), WinRix 1.1 from Rix SoftWorks (Irvine, CA), and Image-in-Color Professional 3.0 from Image-in (Minneapolis, MN). All three support multiple documents, DIBs (device-independent bit maps), button bars, the Clipboard, and pull-down menus.

Virtual memory in 386 enhanced mode enables you to work with multimegabyte bit-map images. The Windows printer drivers allow easy support for high-end output devices, such as PostScript imagesetters, even when you don't have one attached to your computer. Inactive image windows can be reduced to icons.

Image windows can contain true duplicate copies of the same image, a different view of the same image, or another image.



"Zoe," "Dutch Sunflowers," and "Nymph" (counterclockwise from left) are all true color RGB (24-bit) images. "Zoe" and "Dutch Sunflowers" were scanned from 35mm slides; "Nymph" was created with PhotoStyler. On the flowers, I used a circular selection, centered on the flower, inverted the selection, and cleared the rest of the image to black. I then set the background color using the eyedropper and used the magic wand to select the various leaves and clear them. Zooming in, I used the eraser to clear petals from the other

flowers and other unwanted material. For the image of the young woman, I again used a circular selection, but I copied the selection to the Clipboard. Then I used Mask Export and Mask Import to copy the selection circle to the center of the edited flower. The girl's face was pasted from the Clipboard into the selection. The file was saved as a compressed TIFF; the image size was 694 KB, and the file size was 341 KB.

IMAGE EDITORS COMPARED

A variety of features is available with each of these packages. Choosing one is often a matter of balancing necessary and desired features against price.

	Image-in-Color Professional 3.0	PhotoStyler 1.1	WinRix 1.1
Calibration			
Scanner	No	No	No
Display	No	Yes	No
Printer	Automatic	Manual	No
Prescan	Yes	Yes	Yes
Scanning activation	Dialog box or button bar	Dialog box	Dialog box
Scanners supported	Microtek, Sharp, and Epson	Microtek, Sharp, Kodak, Epson, HP, and Nikon	Sharp, Epson, and HP
Button bar Positioning	Fixed to left of window	Anywhere in window or hidden	Anywhere in or out of window or hidden
Number	One	Two	Two
Type	All	Paint, Select	Raster, object
Selection tool placement	Dialog box	Button bar	Button bar
Geometric tools	Lines, ellipses, rectangles, open and closed Bézier curves, polygons	Lines	Lines, ellipses, rectangles, Bézier curves, polygons
Text	Bit map	Bit map	Object
Typeface selection	Slider for entire alphabet	Letter of your choice	No sample
Changing scan resolution	Yes (no scaling)	Yes (with scaling)	No
Image-enhancement gamma functions	No	Yes	No
Image portion selection tools	Rubberband rectangle, square, ellipse, circle, irregular area, magic wand, single line of pixels	Rubberband rectangle, square, ellipse, circle, irregular area, magic wand, single line of pixels	Ellipse, lasso, rectangle, magic wand
Soft Edge depth	32 pixels	5 pixels	No limit
Color-matching standards	No	No	No
File formats supported	IMG, PNT, Targa, PCX, GIF, TIFF, and BMP	Targa, PCX, GIF, TIFF, and BMP	WMF, Targa, PCX, GIF, TIFF, RIx, and BMP
Technical support	M-F 9 AM-6 PM CT; no charge; toll-free number BBS: (612) 888-2324	M-F 7 AM-5 PM PT; no charge; toll call BBS: (714) 476-0728	M-F 9 AM-4 PM PT; no charge; toll-free number
Price	\$795	\$795	\$495

Multiple views let you show different magnifications of an image, zoomed in or out. You can also scroll around an image that's larger than its window by using horizontal and vertical scroll bars.

I evaluated the packages on three systems:

- a standard VGA-equipped 20-MHz 386 with a 14-inch analog monitor, 8 MB of RAM, a mouse, and 30 MB of available space on a 116-MB IDE hard disk;
- a 33-MHz 486 with 16 MB of RAM, a mouse, a 700-MB hard disk, Super VGA (at 1024 by 768 pixels), and a 15-inch multiscan monitor; and
- a 33-MHz 386 with 12 MB of RAM, a trackball, 1024- by 768-pixel Super VGA, and a 15-inch multiscan monitor.

Connected to the 486/33 were Microtek ScanMaker 600Z flatbed and 1850 35mm transparency (slide) color scanners. Later, I connected a Mitsubishi 20-inch multiscan monitor and a Mitsubishi 3600-30 300-dot-per-inch dye-sublimation color printer to the 386/33. The 486/33 and 386/33 are part of a Novell network with about 1 GB of available space on the server.

During this review, I generated about 100 MB of images. Based on my experiences, I recommend certain minimum configurations with these products. A 386 is a must, with at least 60 MB of available disk space prior to installing the image editor (to leave room for the Windows swap file and a few moderate-resolution images).

In addition, 4 MB of RAM is a practical minimum when working with scanned im-

ages at a modest display resolution, such as 640 by 480 pixels—8 MB for better performance and larger images. To work more comfortably with larger images, you would want 16 MB of RAM (or more if you use Windows 3.1). Image files tend to become gigantic, so more (fast) disk space is always helpful.

Scanning Images

To bring photos into the PC, you scan them with an image-editing program. All three of the programs discussed here activate a dialog box for scanning from a pull-down menu entry. Image-in-Color Professional also has a scan tool on the button bar. Since WinRix does not support Microtek scanners (see the table), I couldn't do a hands-on evaluation of its scan capabilities.

New, Lower
Prices!



Windows 3.1

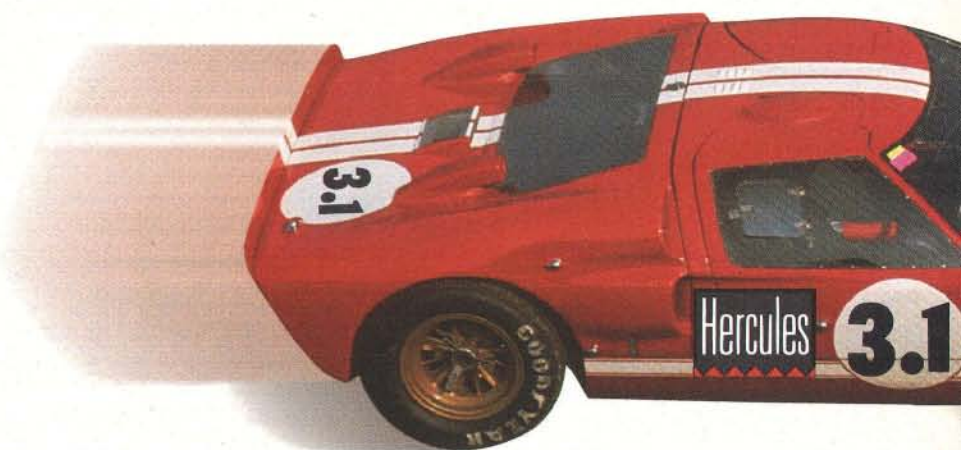

Windows 3.1 With Hercules True Color Accelerator

WARNING!
FAST
WINDOWS
AHEAD

Team up with Hercules and Windows 3.1 and transform your computer into a lean, mean graphics machine.

For dazzling photo finishes, Hercules true color accelerators deliver photo-realistic images in 32,768 to 16.7 million colors!

Your system needs more horsepower to handle Windows — put Hercules under the hood and



Hercules Windows Accelerators: Hercules Graphics Station for ISA and PS/2 buses, Hercules Graphics Station GOLD and the Hercules SUPERSTATION line

outrun sluggish VGA and SVGA. The on-board programmable TI graphics processor also means you'll keep pace with advancing software technology.

And to see real detail, Hercules gives you high resolution and high refresh for flicker-free vibrant displays.

Benefit from Hercules' 10 years of proven high performance graphics experience. Hercules' award-winning technical "pit crew" is there if you need them.

With a Hercules accelerator your colors will **ZOOM** for **well under \$500**.

For more information and the name of a dealer near you, call **800-532-0600**.

World Class
Windows
Performance.



BYTE ACTION SUMMARY

■ WHAT IMAGE EDITORS DO

Windows 3.x-based image editors scan, compose, enhance, retouch, and print color, gray-scale, and black-and-white images.

■ LIKES

The functionality of these products opens the color frontier to a world of image magic on the PC.

■ DISLIKES

None of these products implements any color-matching standards—a potential problem when dealing with scanners, monitors, and printers.

■ RECOMMENDATIONS

For the most versatile panorama of color image-editing functionality under Windows, PhotoStyler wins "best-of-three."

All three products support a quick pre-scan. This is a low-resolution gray-scale or black-and-white scan that's much quicker than a full-color, full-resolution scan of the entire area. You just drop a rubberband-style box over the area. This worked in my tests of PhotoStyler, but not with Image-in-Color Professional, although it has the feature. I called the company and was told that for a flatbed scanner, Image-in-Color Professional needs a new driver that should be shipping by the time you read this. All three products let you scan three types of images: color, gray-scale, and "bi-level" (i.e., black-and-white).

Both PhotoStyler and Image-in-Color Professional support changing resolutions, but the latter does not support scaling (i.e., percentage resizing) at scan time. PhotoStyler also supports image-enhancement gamma functions at scan time to lighten shadows or darken highlights. Gamma functions are more useful when scanning from film (negatives or transparencies) than from a print, since such compensations can be made in the final print.

When you're working with photographic images, consistency in the representation is important. None of the three products I

looked at implements any color-matching standards. This becomes an issue in dealing with the different devices in the process: scanner, monitor, and printer. Standards range from a gray-scale card to the Macbeth Color Checker to the Pantone process colors used in color printing.

PhotoStyler supports display calibration, known as *gamma correction*, and provides a method for determining the gamma values for each of the RGB channels. Both PhotoStyler and Image-in-Color Professional support gamma correction for a printer. Image-in's package provides an automated printer-calibration process; PhotoStyler, a manual one. WinRix does not support printer calibration.

None of the three supports calibration for scanners; if it's required, you'll have to correct the images individually with Tune Gray/Color. In contrast, Micrografix Picture Publisher (which I received too late to fully review for this article) provides a color and gray-scale calibration process for scanner, printer, and display.

Changes and Modifications

While all three products are intended for manipulating true color RGB (24-bit) bit

Interactive true-color image presentations with multi-media control at your command.



Presentation Power

- Windows 3.1 compatible
- Full 16-bit and 24-bit support, with optimized palette color compression on 256-color systems
- Attention-grabbing transitions between images
- Ultra fast loading for BMP, TIF, PCX, GIF, Targa(TGA, VST) and other formats
- Portable presentation generation: one file contains the entire runnable show — *copyright free!*
- Speaker notes: print your notes and images
- File conversion: save any image as a Windows bitmap
- ImageQ Viewer (sold separately): can be controlled by your application through Windows DDE

Ease Of Use

- Slide sorting by name or visual matrix
- Automatic, multiple visual image directories
- Preview window for full size image display
- Cut and paste of text, graphics and images from any other Windows application that supports the clipboard

Presentation Control Language

- Full multi-media support at the MCI string level: incorporate audio, video and device control
- Control of image sequence with keyboard and mouse
- Looping, conditional branching, random image access
- Adjustable run level adapts presentation to audience



ImageQ® \$349 • Contact (800)363-3400

International: (519) 570-9111 Fax: (519) 570-9140

Image North Technologies Inc. • 180 King St. S., Suite 360

Waterloo, Ontario, Canada • N2J 1P8 • Dealer Inquiries Welcome

ImageQ is a registered trademark of Image North Technologies • Windows is a trademark of Microsoft Corporation • Images courtesy Truevision Art Contest © 1991

TO SEE WHY DRAFIX WINDOWS CAD 2.0 IS YOUR BEST CHOICE, PULL UP A CHAIR.

NEW VERSION!

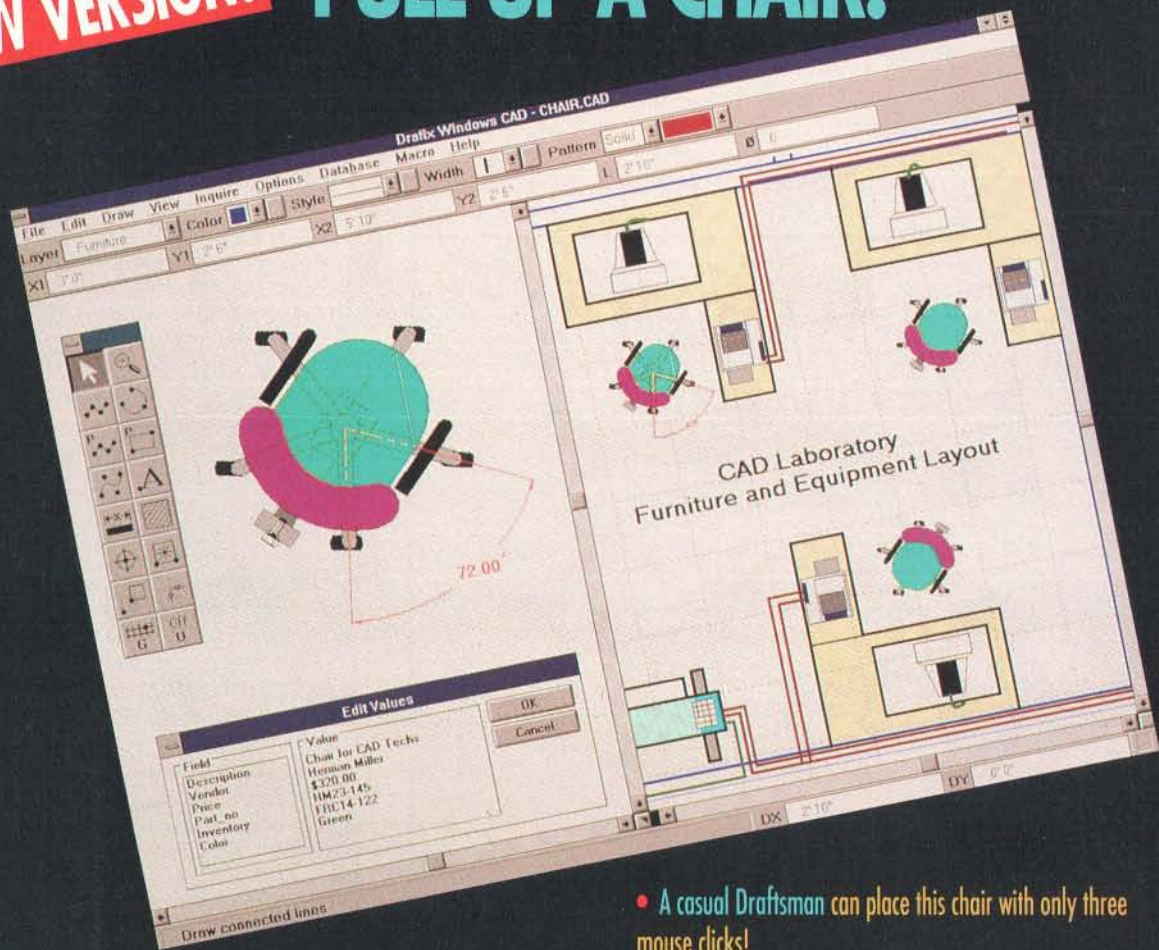

Any drawing or CAD program can draw a chair, but to Drafix Windows CAD users, a chair can be much more!

- A Mechanical Engineer can use the CAD Edit Bar™ to change a chair's dimensions to create a perfect design.
- A Meeting Planner can create a Drafix macro to automatically fill a room with chairs!
- An Architect or Office Planner can assign the chair with up to sixty fields of information such as price, vendor or part number, and generate a Bill of Materials using Microsoft® Excel.

- A casual Drafixman can place this chair with only three mouse clicks!
- A current Drafix Windows CAD user will enjoy the 50 - 100% increase in redraw and entity pick performance!

With Drafix Windows CAD 2.0, anyone can learn to design a chair — or a network diagram, a bridge, a machine tool or a circuit board! And only one package brings total CAD capabilities to Windows. Drafix Windows CAD.

**DRAFIX
WINDOWS CAD**

For your copy of Drafix Windows CAD 2.0,
call 1-800-231-8574 or fax 1-816-891-8018.

FORÉSIGHT RESOURCES CORP. 10725 Ambassador Dr. Kansas City, MO 64153

Circle 26 on Inquiry Card (RESELLERS: 27).

maps, most people don't have a 24-bit display adapter. Although the Windows display device drivers will do the color reduction, the results are not acceptable to the developers of these packages. Each one implements its own RGB color-scaling method and hands the already-scaled DIB to the driver for display.

I evaluated the quality of each product's 256-color simulated 24-bit color display at 1024 by 768 pixels on the Mitsubishi 20-inch monitor. The unequivocal champ

for clarity was WinRix, which managed to retain detail even in low-contrast images by not using a dither pattern. PhotoStyler came close to WinRix, but Image-in-Color Professional came in last with its obscuring dither pattern. I looked briefly at Micrografx Picture Publisher, and I consider it tied for second place with PhotoStyler. Image-in-Color Professional's display was definitely inferior.

The importance of this clarity was emphasized when I tried to do some detailed

editing on a girl's head-shot picture, clearing the background away from her hair. With the Mitsubishi monitor and Image-in-Color Professional, and then PhotoStyler, I couldn't tell hair from background. With WinRix, I could clearly discern where her hair ended and the background began.

In all three products, frequently used functions, such as the paintbrush, are tools on a button bar. With PhotoStyler and WinRix, you can position each button bar anywhere in the application's window or hide it from view; WinRix also allows you to put the button bar outside the document window so that it doesn't obscure any part of the image.

PhotoStyler has two button bars, Paint and Select, with two columns each. WinRix has two alternating button bars: one with raster (paint) tools, and the other with object (draw) tools. Image-in-Color Professional has one fixed button bar to the left of the application window.

The painting tools in all three packages have controls to determine how and when to deposit "paint" on the picture—always, hue only, additive, transparency, flow rate, and so on. You can try out the effect in the scratchpad area in the tool dialog box. The only geometric tool PhotoStyler provides is "paint a straight line." With Image-in-Color Professional, you can draw (paint) lines, ellipses, rectangles, open and closed Bézier curves, and polygons. With WinRix, you have five object-draw tools: line, square and rectangular box, ellipse and circle, Bézier curves, and polygon. Since they are objects, you can individually edit them afterward (as in CorelDraw). When you save a WinRix image with objects, the objects are automatically saved in Windows Metafile (WMF) format.

Since text is supported through Windows, all the fonts you've installed in your copy of Windows are automatically available. An outline font generator, such as Adobe Type Manager, increases selection and quality of compatible typefaces.

PhotoStyler and Image-in-Color Professional incorporate text into the image as a bit map. WinRix text is in outline form when created and saved in the separate object layer. As with all WinRix objects, you can rasterize it into the bit map whenever you like. This ability is especially significant when you're using Adobe Type Manager, because if you leave the fonts as objects they will be printed at the full resolution of the printer (e.g., 300 dpi) instead of that of the screen (e.g., 72 dpi)—and, therefore, at the correct type size.

However, WinRix counters this advantage with the difficulty of selecting a suitable typeface (it doesn't provide a sample). PhotoStyler will convert any letter

Subscription Problems?

We want to help!



If you have a problem with your BYTE subscription, write us with the details. We'll do our best to set it right. But we must have the name, address, and zip of the subscription (new and old address, if it's a change of address). If the problem involves a payment, be sure to include copies of the credit card statement, or front and back of cancelled checks. Include a "business hours" phone number if possible.

BYTE Magazine

Attn. Subscriber Service, P.O. Box 555
Hightstown, NJ 08520

Access dBASE IV and FoxPro files from C or C++

Customer Browse

Customer No.	Last Name	First Name
32482	Stickle	Jim
949	Stickel	Ron
34732	Stice	Vern
35007	Stevenson	Alan
8092	Steward	Baline
22824	Stewardson	
12842	Stewart	
39148	Stewin	
16785	Steyn	
27096	Sthankiya	
15523	Stiansen	
33045	Stickley	

Customer Edit

Customer No.

Last Name

Find

Search On:

Search Value:

Buttons: OK, Cancel

Call for a FREE Browse/Edit utility.

Design CodeBase Browse/Edit screens using any resource toolkit.

- Multi User
- Portable (DOS, Unix, ...)
- Royalty Free DLL
- C++ interface included

Use CodeBase 4.5 from Visual Basic or Turbo Pascal for Windows.

Use the super-fast, super-small FoxPro 2.0 CDX or the Clipper NTX index files.

" Our product was too slow under FoxPro 2.0, so we rewrote it in C using CodeBase. Now it is incredibly fast."

Jeff Reed, DCS Computer Services



CodeBase 4.5

The C Library for DataBase Management

SEQUITER SOFTWARE INC.

TEL. 403-437-2410
 FAX 403-436-2999
 Europe 33.20.24.20.14

#209,9644-54 AVE., EDMONTON, AB, CANADA T6E-5V1

THERE ARE LOTS OF GREAT REASONS FOR BUYING A PS/2



... But The Best Reason is the Aox MicroMASTER Compatible Upgrade to 386™ and 486™ Technology

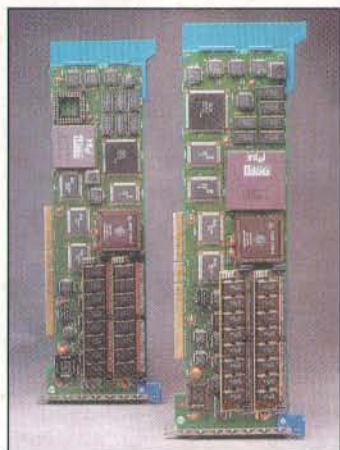

Features of the MicroMASTER:

- ▶ Easy one-step installation—no chips to pull or drivers to install
- ▶ Supports up to 16MB of 32-bit memory on board
- ▶ Runs new generation 80386-based operating systems and applications
- ▶ Compatible with IBM PS/2 models 50, 50z, 55SX, 60, 65, 70, 80, 90 and 95

For further information on the Aox MicroMASTER 386, 486 or our other fine upgrade products, call us toll-free at:

1-800-232-1269

If you bought your 16- or 32-bit PS/2 for its advanced bus architecture, congratulations... because now, Aox MicroMASTER cards let you upgrade all your original PS/2s to the processor and memory level you need today.

A Fast, Reliable Way to 386 and 486 Performance and Compatibility

The MicroMASTER 386 and MicroMASTER 486 are BUS MASTER adapter cards that simply plug into any slot of a MicroChannel-based PS/2. The MicroMASTER takes control of the bus and turns your 286- or 386-based system into a 386- or 486-based powerhouse!

Your new 32-bit architecture opens up a new window to DOS 5.0™, OS/2™, Windows 3.0™, DESQview 386™, and UNIX™ to name a few. And the MicroMASTER has more than enough power to serve as your platform for office automation, database management, file server applications and software development.

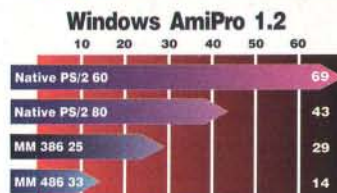
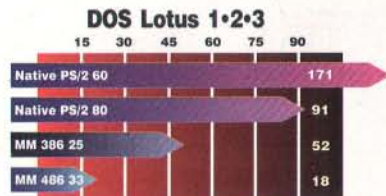

Benchmarks shown in these charts are based on real world applications, taking into account CPU, memory, disk, and video performance. Smaller numbers indicate higher performance.

Aox

MicroMASTER

486 Totten Pond Road, Waltham, Massachusetts 02154 (617) 890-4402 FAX: (617) 890-8445

The High-Performance BUS MASTER That Upgrades Your PS/2 to 386 or 486 Power.

All products are registered trademarks or trademarks of their respective holders. The Intel Inside Logo is a trademark of Intel Corporation.



you enter into the new typeface. With Image-in-Color Professional, you can move a slider through the entire alphabet. If you have more than 70 fonts in your system, trying to use the text tool in Image-in-Color Professional results in an "Unrecoverable Application Error" message. The people at Image-in are aware of this bug and hope to have it fixed in its next release.

PhotoStyler and Image-in-Color Professional provide the same tools for selecting portions of an image: not only the rubberband rectangle familiar to those who use Windows Paint, but a square, an ellipse, a circle, a single line of pixels, an irregular area (freehand and polygonal), and a magic wand. WinRix provides the ellipse, lasso (freehand closed figure), rectangle, and magic wand. Both WinRix and PhotoStyler put the selection tools on the button bar; Image-in-Color Professional has one selection tool—you double-click on it to bring up a dialog box with the various tools.

I found using the ellipse selection in WinRix less than satisfying, since all I could do was tug on the surrounding box's frame at its edit points. WinRix doesn't allow a drag from center: I wanted to cen-

ter the subject's face in the elliptical selection area by placing the cursor on the center and working out from there. Only PhotoStyler lets you continue the rubberband past the edge of the window by automatically scrolling.

WinRix's magic wand selects a region based on similarity to the color at the cursor location. PhotoStyler also uses this principle for functions like "bucket" and gradient fills and the various image-processing functions. Using the magic wand in Image-in-Color Professional on larger images with even a small tolerance resulted in a "Too Many Data Points" message.

In PhotoStyler, you can save selections for use on other images with the Mask Import/Export function. Combined with the selection-inversion control, it makes sophisticated photocomposition available using any number of component images (unlike doing it photographically, where you are limited to only a few). Montages made with all three products are easy and take much less time than in the conventional darkroom.

The Soft Edge command modifies the selection border, giving it a feathered gradual fade over a range instead of a hard-

edged transition. This is useful in making cut-and-paste images look more natural. PhotoStyler limits you to 5 pixels, Image-in-Color Professional to 32; WinRix has no limit.

All three products support changing the size of an image. Since they're specifically designed for scaling photographs, you will achieve better results using them, instead of a page-layout program or the printer driver, for this purpose.

Paintbrush, airbrush, and pencil tools are available for retouching. The clone tool is handy for getting rid of unwanted seams in the image; the bucket fill is useful for larger areas. The eyedropper tool allows an exact color match for painting.

All three products support most major file formats: Targa, PCX, GIF, TIFF, and BMP. WinRix also supports WMF (for objects) and RIX, while Image-in-Color Professional adds support for IMG (Ventura Publisher) and PNT (Macintosh paint).

None of these three products currently supports OLE (Object Linking and Embedding), the Microsoft Windows data-sharing method. In preparation for adding OLE in a future version, WinRix has scroll bars for its entire application window (and

Windows 3.1 Computing Know-How Books and Software from Abacus



Windows 3.1 Complete

The in-depth guide to learning, using, tuning and customizing Microsoft's new Windows 3.1. Packed with practical ready-to-use techniques and extensive reference section. Diskette has two full featured utilities: **Backup**—to safeguard your valuable hard disk data and **Snapshot**—the screen grabber to capture any screen to a file and more. Item #B153. ISBN 1-55755-153-7. \$34.95 includes 3 1/2" companion disk.

Windows 3.1 Intern

For Windows programmers needing the bible for 3.1. Contains background info, sample applications, an exhaustive documentation and covers GDI, bitmaps, color palette manager, DDE, to Windows memory mgmt, DLL and much more. 800+ pages with companion diskette with source code examples. Item #B159. ISBN 1-55755-159-6. \$39.95 with 3 1/2" companion disk.

BeckerTools V3 Power Utilities

Includes new shell with 'drag and drop' convenience, multitasking formatting, single pass diskette copying, hard disk optimizer, defragmenter, hex editor, sector editor, recover, undelete, much more. Intro offer includes **DoubleDensity** disk compression software that doubles your hard disk space. **BeckerTools** and **DoubleDensity** run on IBM 100% compatible XT, AT, 386 or 486 (recommend minimum AT 12 MHz), Windows 3.0 AND 3.1. ISBN 1-55755-143-X. Suggested retail price \$129.95 (with **DoubleDensity**). **DoubleDensity** separately suggested retail price \$79.95.

Abacus
5370 52nd Street SE • Grand Rapids, MI 49512
Phone (616) 698-0330 • FAX (616) 698-0325
Order Toll Free: 1-800-451-4319

In US and Canada add \$5.00 postage. Orders outside North America add \$20.00 surface rate per book.

For fast delivery Order Toll Free 1-800-451-4319 ext. 26, or FAX (616) 698-0325

- Yes, rush () copies of Windows 3.1 Intern. Yes, rush () copies of Windows 3.1 Complete.
 Yes, rush () copies of BeckerTools 3 w/ DoubleDensity. Yes, send your new complete book catalog.
 Visa Master Card Am.Express / Check / M.O. enclosed

MI residents add 4% sales tax. CA residents add 7.25% sales tax. In US and Canada add \$5.00 shipping & handling. Orders outside North America add \$20.00 surface rate per book.

Card #: _____ Expires: _____
 Signature: _____
 Name: _____
 Company: _____
 Address: _____
 City: _____ State: _____ Zip: _____
 Phone #: _____ Dept. BW1

the usual scroll bars on a document window). For a comparison of the features for the three reviewed products, see the table.

Separating the Colors

All three products support color separation—the process of converting a color image into separate images of each of its component colors. In particular, separation into the four process colors—cyan, magenta, yellow, and black (the Pantone color system is CMYK)—prepares an image for reproduction on a four-color printing press.

However, each of these products produces very different separations. While they all follow the same basic concepts relating to optimizing separations, each uses different units to control the optimization, so it's impossible to set them up with identical control parameters. Once you have separated an image, you can send the files to an imagesetter service bureau, which will print them to film negatives to make plates for offset printing.

QuarkXPress on the Mac lets you import separation files and place them on a page layout that can then be sent to the imagesetter. When there are multiple im-

ages on a page, you'll achieve better results by going this route than by letting an imagesetter separate the entire page. Aldus includes a catalog of imaging service bureaus (also known as prepress houses) with PhotoStyler.

Strengths and Weaknesses

WinRix's object capabilities, along with its display scaling, are its strongest points. To accompany this object capability, WinRix comes with a nice selection of object clip art in WMF format. Since they are objects, you can stretch them to suit and combine them with bit-map images. WinRix also comes with ScanRix, a handy Windows screen grabber.

Of all the tools I've used to convert 24-bit images to 8-bit, PhotoStyler produces the best results. While WinRix is as good as PhotoStyler within a narrow range of colors, such as in a low-contrast, tightly cropped head shot, it goes astray when presented with a highlight (yet it has no problem displaying the image in simulated 24-bit color). Image-in-Color Professional does an unacceptable job of converting 24-bit images, showing grossly wrong colors throughout the image.

Help!

PhotoStyler's on-line help is extensive, with the index providing a good quick-start overview. The help function, however, is no substitute for reading relevant portions of the user's manual. For example, I found it impossible to add text to the image until I looked up the procedure. The documentation for spatial effects shows how to make them useful by combining them with image functions.

WinRix has context-sensitive help. Unfortunately, that's all it has. You can't use the help function to browse around for interesting, potentially useful features. Once you wade into a feature, though, the help function will tell you how to operate it.

Image-in-Color Professional's help function mostly consists of nonexplanatory command descriptions. You'll need to have the manual handy for looking things up when using this product.

Technical Support

Aldus has an interactive voice system for technical support that offers prerecorded answers for frequently asked questions. But none of them relates to PhotoStyler, so you must speak to a representative—which

A Short Quiz for America's Executives

1. Would you like to help disadvantaged young people get an education—and a job?
 YES NO
2. Does your company have excess inventory, services or assets that could be used by colleges?
 YES NO
3. Could your company use a tax deduction for qualified inventory donations?
 YES NO

If so, EAL's College Opportunity Program may be for you. EAL targets talented youngsters before they enter their freshman year of high school, then mentors them for four years until they graduate.

How does it work? EAL trades your excess goods and services to a college for tuition scholarships in your name. And the students could intern with you in the summer as part of the package. When they graduate from college, you are the first in line to recruit them.

The result? You get a tax write-off for the donations. And the kids get a leg up with their education. Not bad!

Many of America's top corporations are already committed to EAL.

Why not join them?



Educational Assistance Ltd.™

For information contact:
Peter Roskam
Executive Director
(708) 690-0010
P.O. Box 3021
Glen Ellyn, IL 60138



Big Screen for Windows



"ViewSonic 7 gets our vote as the best overall monitor"

BYTE
MAY 1992

"The ViewSonic 7 is the best value in the test"

WINDOWS
MAY 1992

"The ViewSonic 7 captured the top spot in our tests"



SEPT. 4, 1991

No question... this 17-inch monitor from ViewSonic is the ideal "big screen" choice for Windows. In fact, in a recent InfoWorld product comparison, the ViewSonic 7 was rated #1. Our monitor was designed for people who know what they want and won't accept second best.

The competition claims we're unfair. That's because the up-graded ViewSonic 7, with resolution up to 1280 x 1024, features microprocessor-based memory along with 26 programmable preset modes. And it has a flat square, anti-static screen to eliminate

distortion and provide a sharp to-the-edge picture. Plus, for a flicker-free image, it boasts of ultra-high 76Hz refresh rate. This monitor even meets low-radiation strict Swedish MPR-2 standards!

ViewSonic 7—the ideal 17" big screen monitor for the full-scale Windows environment.

ViewSonic®

12130 Mora Drive/Santa Fe Springs, CA 90670
(800) 888-8583 (310) 946-0711 FAX (310) 946-1618

All products and brand names are trademarks of their respective companies.

Circle 43 on Inquiry Card (RESELLERS: 44).

usually means a 20-minute wait. Aldus's technical-support folks are friendly, knowledgeable (even on obscure topics like color separations), and full of helpful hints. When I wanted to change the color, but retain the shading, of the shirt a subject was wearing in an image, they walked me through the use of fill with hue only.

WinRix technical-support calls always go right through to a friendly representative who knows the operation of the product. When necessary (e.g., for obscure points or

possible bugs), your call is referred to one of the developers.

Image-in technical-support calls usually go right through to a representative. When I called looking for advice on using Image-in-Color Professional to do color separations, I received a clear explanation of what each of the parameters did and was advised that I should use the defaults because they were industry standards and correct for most presses, as established by AgFa Compugraphic.

When to Reach for Each

At \$795, PhotoStyler is a powerful tool for creating image magic on the desktop. For only \$495, WinRix, too, has its uses, particularly when adding text to an image or painting detail areas on a 256-color display system. Image-in-Color Professional, at \$795, has some interesting color prepress features. But (depending on your page-layout software, if any), you may get better results if you hand the prepress operator a color TIFF file than if you try to do the separations yourself with any of these products. It certainly is easier, anyway. While all the imagesetter service bureaus have at least one Mac, they don't necessarily have the software to turn a separated TIFF file into a page for printing. But they will have the software to separate a TIFF file.

In the competition to bring the functionality of color image editing to the desktop, PhotoStyler is the front-runner. While image-editing software is not really new to the PC, these first-generation Windows products bring image-editing capabilities to a much wider audience, because they reduce the need for an expensive 24-bit color display adapter. You no longer need to go to a Mac to do color imaging. ■

Dana Hudes is a freelance software engineer, writer, and photographer. You can reach him as "dhudes" on BIX, where he moderates the photo conference, or at dhudes@mcimail.com on the Internet.

Order BYTE Program Listings on Disk!

For direct ordering call
TOLL-FREE: 800-258-5485.
New Hampshire residents call:
603-924-9281 M-F, 8:30am to
4:30pm, Eastern Time for
credit card orders only.
Subscription Customer Service:
800-232-BYTE.

BYTE listings are available on disk if you want to compile or read the complete source code listings of programs. Disks include any Software Corner programs available for the format you have chosen. BYTE listings are available from December 1985 to the present at the prices stated on the order form.

ORDER FORM: to place your order, complete the information below, and mail to: BYTE on Disk, One Phoenix Mill Lane, P.O. Box 809 Peterborough, NH 03458-0809. Please complete in full.

Name _____
Address _____
City _____
State _____ Zip _____
County or Parish _____ Country _____
Credit Card # _____ Exp. Date _____
Signature _____ Date _____

Please allow 6-12 weeks for delivery.

JUNE

5-1/4 Inch: <input type="checkbox"/> IBM PC	3-1/2 Inch: <input type="checkbox"/> Apple Macintosh <input type="checkbox"/> IBM PS/2
IN USA/Single Month	
<input type="checkbox"/> BYTE listings \$13	<input type="checkbox"/> BYTE Listings \$14
IN USA/Annual Subscription	
<input type="checkbox"/> BYTE Listings \$110	<input type="checkbox"/> BYTE Listings \$120
OUTSIDE USA/Single Month	
<input type="checkbox"/> BYTE Listings \$17	<input type="checkbox"/> BYTE Listings \$18
OUTSIDE USA/Annual Subscription	
<input type="checkbox"/> BYTE Listings \$140	<input type="checkbox"/> BYTE Listings \$150

*Please indicate the issue date below. If you are beginning an annual subscription, note the starting issue.

BYTE Program Listings
Month _____
Year _____

Check enclosed
 MasterCard
 VISA
 U.S. funds enclosed. (If ordering from outside the U.S., please remit in U.S. funds drawn on U.S. bank. Thank you.)

BYTE



COMPANY INFORMATION

Aldus Corp.
(Aldus PhotoStyler 1.1)
411 First Ave. S
Seattle, WA 98104
(206) 628-2320

Circle 1078 on Inquiry Card.

Image-in
(Image-in-Color Professional 3.0)
406 East 79th St.
Minneapolis, MN 55420
(800) 345-3540
(612) 888-3633
fax: (612) 888-3665

Circle 1079 on Inquiry Card.

Rix SoftWorks
(WinRix 1.1)
18552 MacArthur Blvd., Suite 200
Irvine, CA 92715
(800) 345-9059
(714) 476-8266
fax: (714) 476-8486

Circle 1080 on Inquiry Card.

Are You Ready for Windows 3.1?

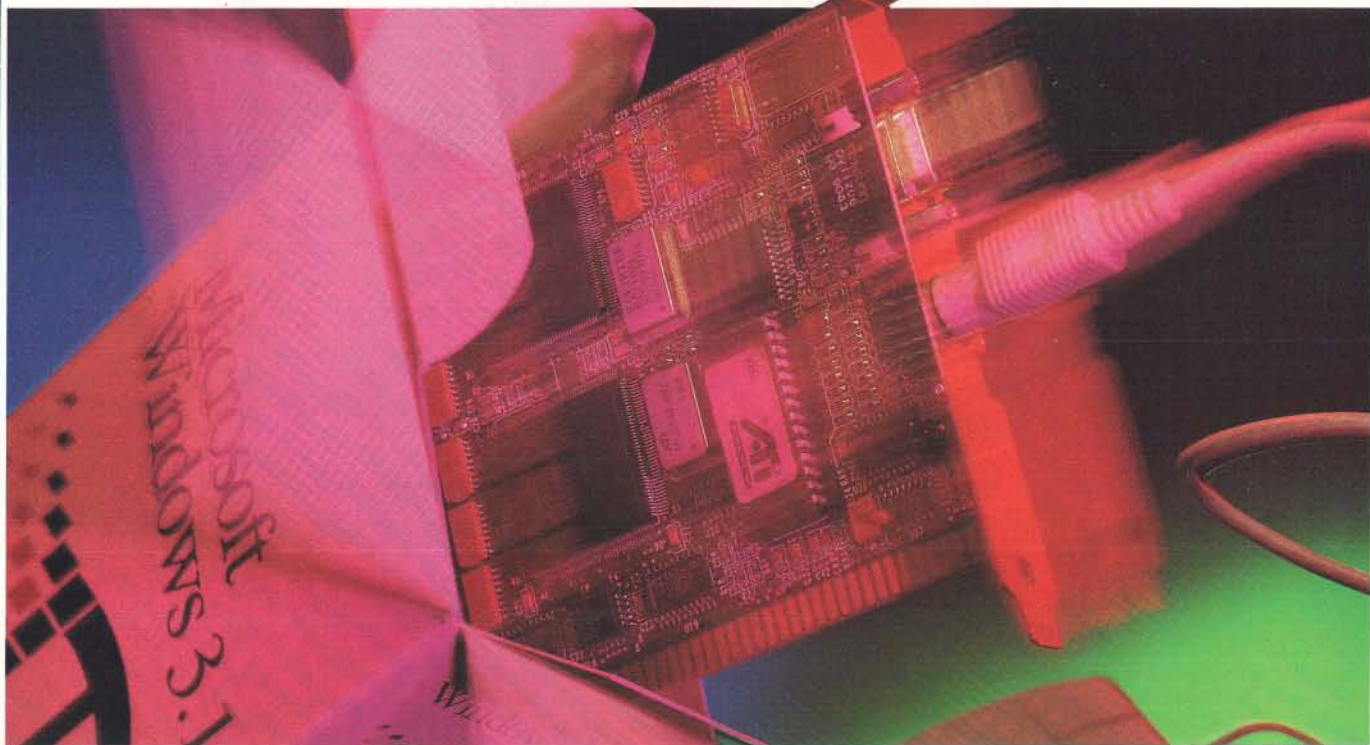

Millions of copies later, Windows has changed the face of computing. Today, ATI welcomes Windows 3.1, a more reliable, usable, and robust graphical user interface.

ATI has affordable, high quality graphics boards with Windows 3.1 drivers available NOW! You can easily obtain these new drivers directly from ATI, or download them from ATI's bulletin board service (416) 756-4591, CompuServe's Windows Forums, or other popular BBSs. And they're faster than ever.

To truly maximize the performance of Windows 3.1 you need graphics acceleration. ATI graphics boards increase the

speed of Windows and all its applications beyond your expectations.

Industry experts state that ATI graphics boards are the best. Year after year ATI graphics products are awarded for their combination of superior features and performance. *PC Magazine's* Editors' Choice, *PC Computing's* Most Valuable Product award, and more.

Think you're ready for Windows 3.1? Ask yourself this. Do you need to increase the speed of Windows applications? View more information on-screen with resolutions up to 1280 x 1024? Increase colors up to 256? Eliminate annoying screen flicker with refresh rates

up to 76 Hz? Or, enhance TrueType to laser quality text using ATI's CRYSTAL Fonts rasterizer? Yes? Then you are ready for ATI Graphics Accelerators.

ATI Graphics Boards— Making Windows Work Better

GRAPHICS ULTRA™

8514 • ULTRA™

GRAPHICS VANTAGE™

VGA WONDER XL™

VGA INTEGRA™

VGA BASIC • 16™



ATI GRAPHICS
ACCELERATORS
AWARDS



ATI TECHNOLOGIES INC.
3761 Victoria Park Avenue
Scarborough, Ontario
Canada M1W 3S2
Telephone: (416) 756-0718
User Support: (416) 756-0711
Facsimile: (416) 756-0720

Copyright © ATI Technologies Inc., 1992. All company and/or product names are trademarks and/or registered trademarks of their manufacturers.

Circle 10 on Inquiry Card.

ASK DR. WINDOWS

Sluggish Windows

Dear Dr. Windows,

I work with Windows 3.0, running Word for Windows, Excel, and so on. I have a 16-MHz 386SX with 8 MB of RAM, a 387SX coprocessor, a 100-MB hard drive, and a VGA card. I use MS-DOS 5.0. I want Windows to be a little speedier. What can I do? Must I use SMARTDRV? With what parameters? Must I use a RAM disk? What size? Should I use a swap file that's permanent or temporary? Must I run Windows in enhanced or standard mode?

Manuel Goncalves
Lisbon, Portugal

Using SMARTDRV or another Windows-compatible disk-cache program can dramatically improve Windows' performance. Since you have 8 MB of RAM, you can easily set aside 2 MB and use it as a disk cache.

If you want to invest in performance hardware, buy a caching drive controller and a fast hard drive. The hardware cache on the controller card, combined with the faster performance of a speedy hard drive, will shave a considerable amount of time off each disk access.

A RAM disk may not give you much of a performance boost. It's usually better to rely on a smart disk-cache program and let it determine which disk sectors should be stored in RAM, rather than copying a large number of files to a RAM disk and using only some of the files. Much of the RAM disk would just be cluttered with useless files that would soak up your RAM.

There's a slight advantage in setting up a swap-file area on your hard disk. You use the SWAPFILE.EXE program to set aside a certain amount of the hard disk for exclusive use by Windows. This provides faster access than a temporary file area would. You also avoid the time delay in creating a temporary swap file each time you load Windows and deleting it each time you exit Windows.

You can try several tricks to improve your video card's performance. If you are using 256-color mode, switch down to 16-color mode, or even monochrome mode. Use the latest version of the Windows driver for your video card. If the current driver is more than a year old, chances are that the manufacturer has written a faster one to improve Windows performance. Make sure your video card is running in 16-bit mode. Check your card's documentation and the switches or jumpers on the board. Also, make sure that no other 8-bit devices on the PC's bus are forcing your video card into 8-bit mode. For a real speed boost, consider upgrading your video card.

Upgrade to Windows 3.1. Microsoft has fixed some of the performance problems that people have found in version 3.0.—Stan Wszola

Windows in a Small Space

Dear Dr. Windows,

According to Microsoft, Windows should run in standard mode on a 386SX with 1 MB of memory, VGA with 256 KB, and DOS 5.0. Well, after three installations



STAN WSZOLA

and much messing around with the AUTOEXEC.BAT and CONFIG.SYS files, as well as enabling/disabling BIOS shadowing, I still can't get the thing to fire up in standard mode. Can you suggest a remedy? We just bought PageMaker 4.0 for Windows, and if I don't get it to work soon, my boss will probably throttle me.

William Byrd
North Little Rock, AR

You're simply going to have to add more memory. PageMaker needs 2 MB, and if you're going to run ATM (Adobe Type Manager), which is a very good idea, you'll want at least 4 MB. Plan on using 4 MB with 1 MB set aside as a disk

cache. Personally, I can't imagine running Windows and PageMaker 4.0 without 8 MB of RAM, with 2 MB for a disk cache (preferably something better than SMARTDRV) and a 256-KB ATM font cache.

If you're really serious about running Windows, I recommend getting a 386DX running at 25 MHz or higher. Make sure it has 8 MB of RAM, and cache the beejabbers out of everything.—Howard Eglowstein

Windows Modes

Dear Dr. Windows,

I've heard people complaining on BIX that DOS 5.0 will not let you run Windows in standard mode—only in enhanced or real modes. Some people point the finger of blame at EMM386.SYS, but I don't know if this is true.

J. Bryan Kramer
Newberry, FL

It is possible to run Windows in standard mode with an expanded memory manager installed. It just depends on which EMS manager you are using. Quarterdeck's QEMM will let you run in standard mode; DOS 5.0's EMM386 and Qualitas's 386Max will not.

If you want to temporarily run in standard mode, just edit your CONFIG.SYS file and insert a REM in the line for your EMS driver. Then reboot and run Windows with the command WIN /S.—Stan Wszola

Where's DOS?

Dear Dr. Windows,

My 3-year-old deleted the DOS-prompt icon from my main program group, and I can't figure out how to get the darn thing back. What program is responsible for the DOS prompt? Normally, when you delete a program from a group, the program is still on the hard drive. But I can't find a program for the DOS prompt. Do I need to re-install Windows just to get it back? I can't find anything on the installation disks that looks like it would help, so I'm assuming there's a switch someplace. I can't find any documentation for it, though.

Tom Jeffries
Oakland, CA
continued



Some people would knock down walls for the kind of freedom we're offering.

Remember images of the Berlin Wall falling: people dancing and singing because, for the first time in generations, they could move freely, with no restrictions.

And it won't discriminate between right- and left-handed users.

Feel free to enjoy these additional features:

- ◆ Windows 3.1 Bundles
- ◆ Infrared Remote Technology
- ◆ Free-Uninterrupted Use By Rechargeable Batteries
- ◆ Strong Driver Software
- ◆ Available now for PCs and Macs

For more information on how to get your hands on our mouse and Windows/Mouse bundles, call Merisel at 1-800-MERISEL. And let freedom ring.



Batteries recharge in our handy mouse holder-unit.

Today, freedom-loving people have another cause to celebrate: the Cordless Super Mouse from Z-NIX.

With no annoying cord to get in the way, the Cordless Super Mouse promises ultimate freedom of movement — from distances up to 6' away — to take full advantage of the Windows® revolution.

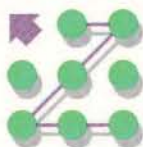

Z-NIX COMPANY, INC.

211 Erie Street, Pomona, CA 91768

No Strings Attached.



For more information about other Z-NIX products, call (714) 629-8050.

Circle 50 on Inquiry Card.

It's true! You can write your application just once in C or C++, and link it with an XVT library to get a native application for the GUI system of your choice. Not only have we been shipping XVT for over 3 years, but our customers are shipping their applications, too! Call today for full details, including a free, twenty-page XVT Technical Overview.

XVT Software Inc.
Box 18750, Boulder, Co.
80308 USA
303 443-4223
FAX 303 443-0969



XVT is a trademark of XVT Software Inc.
Motif, OPEN LOOK, Macintosh, MS-Windows,
and OS2-PM are trademarks of their vendors.

You can develop portable GUI applications with XVT!

for:

- Motif
- OPEN LOOK
- Character Displays
- Macintosh
- MS-Windows
- OS/2-PM

Don't Move without telling

BYTE

Clip out form below mail to:

BYTE Magazine
Subscriber Service
P.O. Box 555
Hightstown, NJ 08520

At least 8 weeks before you move, please give us your new address and/or name change. (Please Print)

New address, name

Name _____

Address _____ Apt. _____

City _____

State _____ Zip _____

Print current name and address

(or affix the mailing label from your current issue of BYTE here)

Current address, name

Name _____

Address _____ Apt. _____

City _____

State _____ Zip _____

ASK DR. WINDOWS

Windows is funny in that running a DOS session is more like running an application than like going to the operating system. To restore your DOS-prompt icon, run Windows and open your main program group. Then click on the File item in the Program Manager's menu bar; this will display the options. Click on New; this will display the New Program Object window. Click on Program Item and OK. Next, you'll see the Program Item Properties window. On the Description line, type DOS Prompt, and on the Command line, type in the location for COMMAND.COM (e.g., C:\DOS\COMMAND.COM). What you're doing is making a new DOS Program Manager icon.

An alternative is to use the PIF (program information file) Editor to create a custom PIF for DOS. This method lets you enter options such as reserving more environment space for DOS. Either method works.

For the future, I suggest you copy the DOS prompt into another program group, in case your young Windows user experiments with using the delete command again.

—Stan Wszola

TIPS FROM THE DOCTOR

Beyond COM2

Many users have reported trouble using Windows 3.0 with COM ports 3 and 4. Windows 3.0 recognizes all four COM ports, and you can configure the setting for each port via the Control Panel. But Windows 3.0 refuses to share a hardware IRQ (interrupt request), and that's partly what's causing the problems.

You can have up to four serial ports, each with its own I/O address, but the four ports share two interrupts:

Port	Address	IRQ
COM1	3F8h	4
COM2	2F8h	3
COM3	3E8h	4
COM4	2E8h	3

Problems arise, for example, if you are using a serial mouse on COM1 and you have an internal modem on COM3. This setup won't work because the mouse and modem are in contention for the interrupt that is shared between COM1 and COM3. This problem also occurs if you are using a serial mouse on COM2 and want to use an internal modem on COM4.

COM3 and COM4 may not work reliably under Windows 3.0 (in standard and real modes) unless both COM1 and COM2 are first activated. So, in general, don't use a serial port with one of the higher numbers (2, 3, or 4) unless all lower-number ports are first activated or in use.

If you are running in 386 enhanced mode, you should also check the default setting in the 386ENH section of the SYSTEM.INI file for proper functioning of the ports. You should add these four lines to that section:

```
COM1BASE=3F8h
COM2BASE=2F8h
COM3BASE=3E8h
COM4BASE=2E8h
```

continued

PICTURE WINDOWS.

Picture This... a real-time television monitor built right into your PC... Now, picture using this monitor while running Windows™ 3.0 applications **at the same time...** And, picture taking that video image and resizing, (**right down to crystal-clear icon size!**) or clicking and dragging it to any position on the screen as easily as moving any other Window...

Now you can! Any Windows 3.0 user can access 122 channel television reception with the built-in tuner, PLUS two additional video sources, (such as VCR, video camera, laser disk, etc.,) all with stereo audio capability! Automatically fit real-time video images into any size Window while running your other Windows 3.0 programs. *Hauppauge Computer Works* introduces **Win/TV™**, the Windows television adapter.

Picture Perfect. A "frame-grabber" feature allows you to capture any desired "still" from a video source and save it to disk. With **Win/TV**, you can integrate video images into multi-media applications such as training or marketing presentations. All you need is Windows 3.0, a VGA monitor, and a system with a spare 16-bit I/O slot, and you are ready to view a whole new world of video creativity!

Picture Yourself owning your own "Windows on the World"! Maybe you want to work on your spreadsheets but don't want to miss an important news flash or a current stock market report. **Win/TV** is *perfect* for you. Keep an eye on current events while keeping control of your inventory... No problem!

Get the new **Win/TV** and open a window on some fresh, new and exciting possibilities.

Circle 28 on Inquiry Card.



SUGGESTED
RETAIL
\$495.

You're never out of touch with your own personal "Windows on the World"!



Resize or reposition your Win/TV Window anywhere on the screen — while running other Windows applications.



Capture the perfect "still" with "Frame Grabber" feature — great for presentations with impact.

Hauppauge!

Hauppauge Computer Works, Inc.
91 Cabot Court • Hauppauge, N.Y. 11788
In N.Y.: Tel: (516) 434-1600 • Fax (516) 434-3198
Toll Free: 800-443-6284 • In Europe: (49)-2161-17063

are you cramped for disk space?

add up to 170MB of
detachable storage with a
simplicity portable drive

- ▼ Attaches **instantly** to any PC parallel printer port, no card needed
- ▼ Gives you **extra storage**
- ▼ Lets you use the **same programs** at home, office, and client
- ▼ Perfect for **laptops, PS/2s, and demos**
- ▼ **Reliable. Rugged. Small.**



170MB \$1299, 120MB \$899, 80MB \$699, 40MB \$499
Seven hour battery, carrying case, and 220V power available

to order, or for free info:
call **(800) 275-6525**

30 day money back guarantee, 1 year warranty
Visa/MC/Amex accepted, overnight shipping



126 W. 23rd St. ▼ New York, NY 10011 ▼ Phone (212) 229-1625 ▼ Fax (212) 229-2938

A MESSAGE TO OUR SUBSCRIBERS

FROM TIME TO TIME WE MAKE THE BYTE SUBSCRIBER LIST available to other companies who wish to send our subscribers material about their products. We take great care to screen these companies, choosing only those who are reputable, and whose products, services or information we feel would be of interest to you. Direct mail is an efficient medium for presenting the latest personal computer goods and services to our subscribers.

Many BYTE subscribers appreciate this controlled use of our mailing list, and look forward to finding information of interest to them in the mail. Used are our subscribers' names and addresses only (no other information we may have is ever given).

While we believe the distribution of this information is of benefit to our subscribers, we firmly respect the wishes of any subscriber who does not want to receive such promotional literature. Should you wish to restrict the use of your name, simply send your request to the following address.

BYTE Magazine
Attn: Subscriber Service
P.O. Box 555
Hightstown, NJ 08520



ASK DR. WINDOWS

The procedure for modifying the SYSTEM.INI file for Windows 3.0 is described in detail in SYSINI2.TXT under the 386ENH section.

Windows 3.1 avoids this problem because each port can be assigned a unique IRQ. You can configure each port through the Advanced Settings section of the Ports dialog box in the Control Panel.

Icon Space

Windows assigns each icon a standard amount of space on the desktop. Sometimes you want to give an icon a long, descriptive label, but when you've got a lot of icons on the screen, the labels overlap. The remedy? Adjust the spacing between icons.

Here's how: Go into the Control Panel and click on the Desktop icon. Move to the Icon Spacing text box and click on the up and down arrows, or enter a number in the box, to increase or decrease the icon spacing (the numbers represent the spacing in pixels). The new spacing will take effect the next time you rearrange your icons.

You can also arrange your icons according to an invisible grid. The icons will snap into place along the invisible lines of the grid. Again, click on the Desktop icon and choose the Granularity text box. Click on the up or down arrows to change the spacing of the grid. The range is 0 to 49. A 0 will turn off the grid; a 1 will create a grid with intersections every 8 pixels; a 2 will place intersections every 16 pixels; and so on.

Hazards to Your Health

If you are running a DOS session under Windows, there are some DOS commands or programs that you shouldn't run. Even when Windows is suspended during a DOS session, some DOS commands or programs can disrupt or damage the Windows files that are still open.

It's acceptable to use the CHKDSK command, but not CHKDSK/F. The /F or "fix" variant of the command looks for cross-linked files and can confuse open Windows application files for corrupted files.

Never optimize your hard disk while running Windows. Programs like Vopt or Norton's Speed Disk can rearrange the location of clusters and files, leaving Windows without a clue to where some essential information is located.

Some DOS commands, such as APPEND, ASSIGN, JOIN and SUBST, may confuse Windows by changing the drive designations.

Switching Tasks

One of the handiest Windows keyboard shortcut commands is Control-Escape. This command lets you call the Task List and switch to another application. For example, you can be running a non-Windows program, such as a favorite word processor, and, by pressing Control-Escape, switch to the Task List and select the Program Manager. From the Program Manager, you can run any other Windows application, and then you can press Control-Escape to switch back to your word processor. ■

Dr. Windows, also known as Stan Wszola, is assisted in his diagnoses by Howard Eglowstein, and Ray Côté, testing editors for the BYTE Lab. You can reach them on BIX as "stan," "heglowstein," and "rgacote," respectively.

WINDOWS ACCELERATOR

32,768 Colors

20 Times Faster than Super VGA

Featuring the PRIMUS P2000



GRAPHICS ACCELERATOR

PC Magazine, BYTE and Windows Magazine all agree that the most cost effective way to improve your Windows performance is to install a Graphics Accelerator card.

20

TIMES FASTER

The Celerite Windows Accelerator card uses the Primus

P2000 chip to provide co-processed BitBLT, color expansion and line drawing up to 20 times faster than Super VGA.

80 MHZ VIDEO CLOCK

The high-speed clock allows the Windows Accelerator to support 1024 x 768 x 256 color in 72Hz Non-Interlaced Display mode.

HiCOLOR & HIGH RESOLUTION

The 2MB RAM option supports 256 colors at 1280 x 1024 resolution. It also supports 32,768 colors at 800 x 600 and 640x480 resolution.



32,768

SOFTWARE DRIVERS INCLUDED

Windows 3.0 and the fastest AutoCAD driver "AutoBoost." Also, DOS drivers for Lotus 1-2-3, Symphony, WordPerfect, GEM and Ventura Publisher. Additional new and updated drivers can be downloaded from our BBS.

Fully compatible with VGA, EGA, CGA, MDA and Hercules.

only



For Sales Information, Orders and Tech Support, Contact:

CELERITE GRAPHICS INC.
46560 Fremont Blvd., Suite 113
Fremont, CA. 94538

1-800-472-7820 Voice line
(8:30-6:00 Pacific Time, M-F)

1-800-472-7819 Auto FAX reply
(24 hours, 7 days)

1-510-226-6393 Regular FAX line
(24 hours, 7 days)

Payment-VISA, MASTER, American Express or C.O.D. Warranty-30 day money back (shipping and handling non-refundable), 1 year parts and labor free. Tech Support-Free unlimited telephone support, 24 hr BBS (1-510-226-7851, 8N1).

P2000 is a trademark of Primus Technology, Inc. Windows is a trademark of Microsoft, Inc. AutoCAD is a trademark of AutoDesk, Inc. Lotus 1-2-3 and Symphony are trademarks of Lotus Development Corp. GEM is a trademark of Digital Research, Inc. Ventura is a trademark of Xerox Desktop Software. Hercules is a trademark of Hercules Computer Technology.

Circle 322 on Inquiry Card (RESELLERS: 323).

Ada comes to Windows

Introducing the Janus/Ada Windows Toolkit.

Now you can use the power of Ada in your Microsoft Windows applications. Ada's design makes managing large Windows applications easy. All of Ada's powerful features can be used in Windows applications, including multitasking, generic units, and exception handling. Features of the Janus/Ada Windows Toolkit include:

- Complete Windows API binding
- Ordinary Ada programs can be made into WinApps without source changes
- Source level debugging with Codeview

The Janus/Ada Professional Development System, on which the Toolkit is based, is a fully validated Ada compiler for MS-DOS. It embodies our 11 years of Ada compiler experience for PCs, and includes many valuable features for Windows programmers. Some highlights are:

- Comprehensive and easy to use Interface to C (including subprograms and objects)
- Low-level programming support, including bit addressible record components
- High quality error handling

Janus/Ada: The PC Ada Compiler



Phone: 800-722-3248
or 608-251-3133
FAX: 608-251-3340



THIS PRODUCT CONFORMS TO ANSI/MIL-STD-1815A AS DETERMINED BY THE AJPO UNDER ITS CURRENT TESTING PROCEDURES

P.O. Box 1512, Madison WI 53701-1512

New Origin™ Version 2.0 Scientific Graphics and Data Analysis in Windows

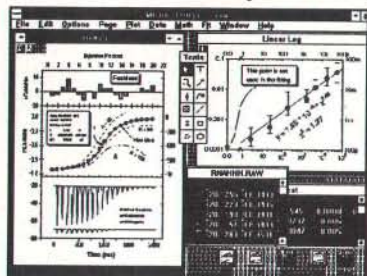

"I have used SigmaPlot, EasyPlot, and several others. I would rate Origin at the very top... This is the best scientific software I have found... I love this product!"

Dr. Dipen N. Sinha
Physicist
Los Alamos National Laboratory

FEATURES INCLUDE:

- Many chart types, including line, scatter, column, bar, area, error bars, hi-lo-close, spline, step, box, QC charts, and contour.
- Create charts in multiple WYSIWYG windows with zooming, scrolling, and easy double-click editing of all graphic elements.
- Sophisticated "layer" system makes it easy to put multiple graphs on a page.
- Function plotting, statistics, t-Test, histogram, regression, curve fitting to user-defined models, and much more.
- Superior publication-quality output. Makes beautiful color slides.
- A powerful scripting language lets you create custom applications. Also supports DDE and DLL.
- Ideal for OEM Applications.

only \$495.00
\$600 overseas

60 day money back Guarantee

Call 1-800-969-7720

FREE demonstration disk available.

MicroCal, Inc., 22 Industrial Dr. E., Northampton, MA 01060
TEL (413) 586-7720 FAX (413) 586-0149

**800DPI, 256 Grey Scale Laser Printing & 285 Postscript Fonts – Only \$695 !!

- Prints All Windows 3.0 & 3.1 Applications 5-10X Faster
- 800DPI Output for HP & Canon Series II & III 8PPM Laser Printers
- 285 Postscript Fonts With Special Effects & Headlines
- Microsoft Windows 3.1 TrueType™ Compatible



Now you can turn your Canon or Hewlett Packard 8 PPM Laser Printer into a Professional Image and Typesetting System! (Not avail. for HP IIP or IIIP printers).

Whether you are using Corel Draw, Arts & Letters, Designer, PageMaker, or Ventura for Windows; the LaserEdge System provides you with the utmost in printing performance! It is also compatible with Adobe Type Manager™ and Bitstream FaceLift™ to give you all the industry standard Postscript fonts available!

The Complete System Includes: SCSI Host Adapter, Video Printer I/O Card, Cable, Windows S/W Driver, Quick Installation User Manual and over 280 Postscript Fonts Scaleable from 4-650 Pts. Dealers & Dist. welcome.

Call CSI @ (800) 842-2486 Intl. (714) 628-7873 Fax: (714) 590-0392
3233 Grand Avenue, Suite N202, Chino Hills, CA 91709

**Requires 386-20 Comp. W/8MB Memory in Windows 3.0/3.1 Enhanced Mode.

The universal client/server solution, guaranteeing you full freedom of choice

Just tell us about your environment. We will send you a customized solution.

SERVER	DATABASE	NETWORK	CLIENT	APPLICATIONS
<input type="checkbox"/> AS/400	<input type="checkbox"/> ORACLE	<input type="checkbox"/> NETBIOS	<input type="checkbox"/> WINDOWS 3	<input type="checkbox"/> EXCEL
<input type="checkbox"/> VAX/VMS	<input type="checkbox"/> RDB	<input type="checkbox"/> TCP/IP	<input type="checkbox"/> MACINTOSH	<input type="checkbox"/> LOTUS 1-2-3
<input type="checkbox"/> UNIX	<input type="checkbox"/> INGRES	<input type="checkbox"/> DECNET	<input type="checkbox"/> UNIX	<input type="checkbox"/> EASEL
<input type="checkbox"/> MVS	<input type="checkbox"/> SYBASE	<input type="checkbox"/> APPC	<input type="checkbox"/> OS/2	<input type="checkbox"/> HYPERCARD
<input type="checkbox"/> OS/2	<input type="checkbox"/> DB2	<input type="checkbox"/> APPLETTALK	<input type="checkbox"/> VAX STATION	<input type="checkbox"/> VISUAL BASIC
<input type="checkbox"/> VM	<input type="checkbox"/> SQL/400	<input type="checkbox"/> NETWARE	<input type="checkbox"/> _____	<input type="checkbox"/> 4TH DIMENSION
<input type="checkbox"/> _____	<input type="checkbox"/> SQL SERVER	<input type="checkbox"/> LAN MANAGER		<input type="checkbox"/> SMALLTALK
	<input type="checkbox"/> OS/2 DBM			<input type="checkbox"/> OMNIS 5
	<input type="checkbox"/> INFORMIX			<input type="checkbox"/> C, PASCAL
	<input type="checkbox"/> _____			<input type="checkbox"/> _____

Please mark which standards you use. Take a photocopy and mail or fax it to us.

Name:

Company:

Job Title:

Address:

City:

Post Code:

Country:

Telephone:

Fax:

GnOsIs NV
Kardinaal Mercierlei 30
2600 Antwerp
BELGIUM
Tel: +32/3/230.02.22
Fax: +32/3/218.87.82

TechGnOsIs France
2, Chemin du Pigeonnier
de la Céprière
31100 Toulouse
FRANCE
Tel: +33/61.76.17.18
Fax: +33/61.76.18.44

TechGnOsIs (U.K.) Ltd.
3 Acorn Business Centre
Heaton Lane, Stockport
Cheshire SK4 1AS
UNITED KINGDOM
Tel: +44/61.474.19.63
Fax: +44/61.474.19.58

TechGnOsIs, Inc.
Northern Trust Plaza
301 Yamato Road, Suite 2200
Boca Raton FL 33431
USA
Tel: +1/407.997.6687
Fax: +1/407.241.6143

SequeLink
Client/Server MiddleWare

DYN. DE Visscher & Van Nieuw
BYTE '92

16 million colors for Windows 3 6 high-res graphics cards for SuperVGA up to 64/78 KHz multi-scan monitors.



Available for the PC ISA bus, ETAP Greco color graphics cards allow Windows users to display their applications on 8 or 24 bits at high resolutions. The cards are shipped with drivers for Windows 3 and GEM/Ventura Publisher and emulate VGA and SuperVGA programs with a flicker-free 75 Hz refresh rate. Also, they allow to work with a mouse-controlled virtual screen under Windows 3. ETAP Greco cards use dedicated Windows-processing chips conceived for fast bit-BLT and work around a wide 64-bits video memory bus and read-and-write cache.

The cards are targeted at professional Windows users, heavily involved in office applications (Excel, Winword....) and DTP/Imaging applications on 386/486 PCs.

The new ETAP Greco color cards are available in different configurations and power monitors ranging from SuperVGA auto-scan (e.g. NEC 4D) up to 64/78 KHz large-screen monitors (NEC 5D, EIZO, Flexscan, Taxan,....). They are also available from ETAP as complete display systems with large-screen Trinitron monitors.

ETAP
INFORMATION TECHNOLOGY

Steenovenstraat 1A
B-2390 Malle, Belgium
Tel.: +32 33 10 04 11
Fax: +32 33 11 76 38

DATA ACQUISITION AND INSTRUMENT CONTROL with Windows 3.1

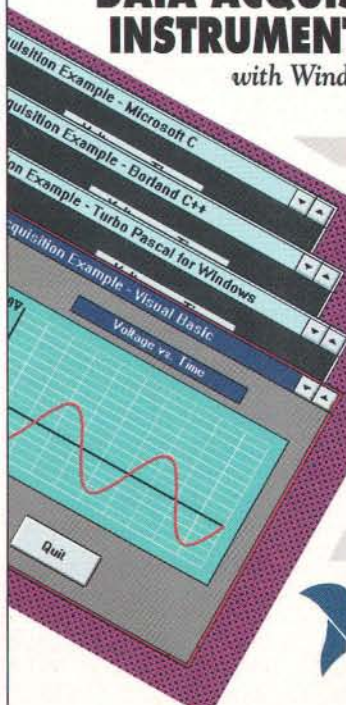

Dynamic Link Libraries

Integrate Windows applications and programs with DLLs for:

- Plug-in Data Acquisition Boards
- IEEE-488.2 Interfaces
- VXI Controllers

Use with standard Windows programming tools, including:

- Microsoft Visual Basic
- Microsoft C/SDK
- Borland C++
- Turbo Pascal for Windows

Call for Free Brochure

NATIONAL INSTRUMENTS®
The Software is the Instrument®

6504 Bridge Point Parkway
Austin, TX 78730-5039
Tel: (512) 794-0100
(800) 433-3488
(U.S. and Canada)
Fax: (512) 794-8411

Branch Offices
AUSTRALIA 03 879 9422 • BELGIUM 02 757 00 20 • CANADA 519 422 9310 • DENMARK 45 76 73 22 • FRANCE 1 48 65 33 70
GERMANY 089 714 50 93 • ITALY 02 48301892 JAPAN 03 3788 1921 • NETHERLANDS 01720 45761 • NORWAY 03 846866
SPAIN 91 896 0675 • SWEDEN 08 98 49 70 • SWITZERLAND 056 45 58 80 • U.K. 0635 523545

Product names listed are trademarks of their respective manufacturers. Company names listed are trademarks or trade names of their respective companies. © Copyright 1992 National Instruments Corporation. All rights reserved.

The Programmer's Shop™



GATE by InfoMentor Software

The Leader in Software Testing Tools

GATE is an industrial strength testing tool for easy, automated testing of all software. GATE provides professional capture playback features for mouse events, graphic screens, as well as keystrokes and text screens. Find bugs quickly with automated status reports. Also, combine GATE with terminal emulation software for your mainframe testing. GATE works with ON STAGE Software Test Library Manager for truly automated software testing.

	List	PS Price
GATE:	\$395	\$350
ON STAGE:	\$595	\$525

FastFaxes 5170-001, 5170-002



InstallBoss 3.5 by Kedwell Software

Installation for program generator for MS-DOS based computers. It generates professional installation programs and procedures for your software application. InstallBoss is menu-driven and uses a compression utility, and checks Config.sys and Autoexec.bat files. Prepares distribution diskettes for easy installation.

LIST: \$170 PS Price: \$149
FastFaxes 5277-001



The PKWARE Data Compression Library by PKWARE

The PKWARE Data Compression Library allows software developers to add data compression technology to applications. The application program controls all data I/O, allowing data to be compressed or extracted to any device or area of memory. Only 35K of memory is needed to compress data, and only 12K is needed to extract data. Compatible with MSC, BC++, TC, TP 6.0, Clipper, Basic 4.5, 7.1, ASM.

LIST: \$295 PS Price: \$275
FastFaxes 3043-011



allCLEAR v1.1 by Clear Software

Give clarity and impact to every policy, procedure, and written idea. allClear automatically converts ordinary text into presentation-quality flow charts, diagrams and decision trees. Just like numbers are explained with pie, line and bar charts, allCLEAR illustrates words with diagrams--people learn faster and make fewer mistakes.

LIST: \$300 PS Price: \$259
FastFaxes 873-008

386 DEVELOPMENT

	LIST	PS
386 Max 6.0	\$100	\$75
386 DOS Extender SDK	495	479
Blue MAX	125	99
DESQview 386	220	189
High C 386/486	795	749
QEMM 386	100	75
SVS C3/ANSI C Comp.	1195	325
WATCOM C9.0 386	895	739
C Code Builder	695	579

C/C++ COMPILERS

Microsoft C/C++ Dev.Sys.	495	349
WATCOM C 9.0	495	439
BORLAND C++	495	379

COMMUNICATIONS

ADD-ONS

C Asynch Manager 3.1	219	189
Essential COMM	329	249
Greenleaf Comm Library	359	329
QuickComm	149	129
Comm-DRV	90	79
Comm-LOG	90	79

DBMS

CLARION Prof. Dev.V2.1	845	475
Clipper 5.01	795	570
dBASE IV	795	595
Arago dBLX	699	599
FilePro Plus	699	669
FoxPro 2.0	795	499
Paradox V3.5	795	555
Arago QuickSilver	799	649

DBMS TOOLS & LIBRARIES

	LIST	PS
Artful Two	\$295	\$285
Accsys for dBASE	395	349
CLEAR + for dBASE	200	179
CodeBase 4.5	395	349
dBX/dBport w/source	1000	895
dGE 4.1	295	279
dSalvage Professional	200	195
Essential B-tree w/source	199	149
Faircom c-tree Plus	595	495
Flipper	295	279
FUNcky.LIB	249	239
Matt Whelan's Comp. Kt	1190	1029
Nantucket Tools II	695	499
Net Lib	299	269
Novell BTRieve	595	479
Pro Clip	99	95
R&R for dBASE & Comp.	249	229
R&R Code Generator	199	159

DISASSEMBLERS

Dis/Doc Professional	250	229
Periscope IV	Varies	
Sourcer 486 w/BIOS pre-proc.	170	149

DEVELOPMENT TOOLS

AllClear	300	259
ASMFLOW Prof.	200	179
Blinker	299	279
dANALYST Gold	495	100
C-DOC	189	179
Charge	75	69



SLATE with Graphics by Symmetry Group

SLATE with Graphics is a universal printer driver library. It supports dot matrix, laser, and PostScript printers. It includes over 250 text and graphic printing functions to select fonts, print text, print images from the screen, PCX, and TIFF files, and much more. It allows royalty-free distribution of your application, the 750 printer database, and the setup and testing programs.

LIST: \$448 PS Price: \$419
FastFaxes 891-005



SQA:ROBOT for Windows by Software Quality Automation

Fully-automated test development and unattended test execution for any Windows application. SQA:ROBOT generates scripts that can be maintained by non-programmers. Other unique features include: standalone or networked operation; run-time only option: easy to use, intuitive user-interface; user-selectable recording level generates Visual Basic scripts or low-level mouse and keystroke journal; and integrated test reporting using SQA: Manager, winner of Computer Language's 1992 Productivity Award.

LIST: \$995 PS Price: \$925
FastFaxes 5305-001

THE PROGRAMMER'S SHOP 1-800-421-8006

All prices subject to change. International prices will vary.

National Accounts: 800-446-1185 FAX: 617-749-2018

We give developers what they need...

- Tools to automate every aspect of the development cycle – over 5,000 in all
- FREE pre-sales technical support

NEW VERSION!

Matt Whelan's Compiler Kit™ -dBASE IV® Edition by Nantucket

Matt Whelan's Compiler Kit—dBASE IV Edition creates stand-alone, executable files from dBASE IV applications that can be freely distributed without royalty or runtime software. Using the compile capability in Clipper® 5.0 (software included in U.S.), Matt Whelan's Compiler Kit accepts most dBASE IV programs without modification, producing .EXE files in one step. No knowledge of Clipper is needed.

LIST: \$1190 PS Price: \$1029
FastFacts 1139-006



SMARTCOM EXEC™ by Hayes Microcomputer

Smartcom Exec™—Powerful communications software that combines terminal emulations, error-control protocols, and a text editor to meet the needs of virtually any user. In addition to modern sharing support over a LAN, Smartcom Exec provides SCOPE scripting language, keyboard macros, mouse control, five language support, and more to provide the ideal program for business and home use.

LIST: \$129 PS Price: \$119
FastFacts 1952-019



NEW VERSION!

BLINKER 2.0 by Blink, Inc.

Fastest dynamic overlay linker for C, C++, ASM, BASIC, Clipper, QuickBASIC, Fortran, etc., with new integrated memory swap function designed to save time and memory. Automatically creates fast, stable overlaid .EXEs to reduce memory requirements. Uses XMS/EMS to save currently executing program and run a second within the first. Features CodeView support and overlay caching to XMS/EMS for optimum runtime performance.

LIST: \$299 PS Price: \$279
FastFacts 2933-006



NEW VERSION!

WATCOM C9.0/386 by WATCOM

Develop and debug 32-bit applications for extended DOS, Windows and OS/2 2.0. Includes royalty-free 32-bit DOS extender, true 32-bit Windows GUI Application Kit, our fast, tight, and reliable 32-bit Code Optimizer, licensed Microsoft Windows SDK Components, an interactive Source-Level Debugger, an Execution Profiler and More! Now includes OS/2 2.0 support.

LIST: \$895 PS Price: \$739
FastFacts 1044-020

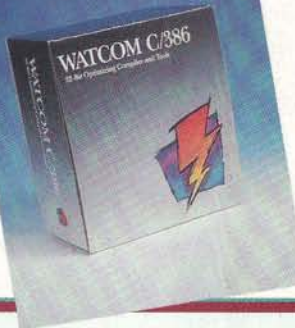

	LIST	PS		LIST	PS
CLEAR+ for C	\$200	\$179	GraphBASE	\$100	\$95
Codan	395	349	GX Graphics	199	189
Install	250	219	HEADROOM	130	89
INSTALLIT w/source	249	229	HiJaak	199	149
MKS Toolkit	249	229	Mace Utilities 1990	149	99
Optlink	150	139	PC Tools Deluxe 7.1	179	149
PC-Lint DOS/OS2	139	115	PC-KWIK Power Pak	130	95
PVCS Config. Builder	250	219	PGL Toolkit	195	185
PVCS Version Manager	600	529	QuickNet	199	195
.RTLINK Plus	495	419	PASCAL		
.RTPatch	295	269	MetaWare Prof. Pascal	495	480
Sourcerer's Appr. Prof.	499	459	Microsoft Pascal	300	199
EDITORS			Pascal ASYNCH Mgr.	175	159
BRIEF	249	Call	Turbo Pascal 6.0	150	109
BriefFor C++	129	119	WINDOWS & OS/2		
dBrief	129	119	ACTOR Professional 4.0	495	449
Epsilon	250	229	BRIEF for OS/2	249	Call
KEDIT	150	139	Case: PM (for C or C++)	1995	1899
PVCS Profes. Editor	300	249	Case: W Corp. Edition	995	969
SPF/PC	295	249	dBFAST/Windows	550	399
SpeedEdit	295	265	DialogCoder	549	539
Vedit +	185	159	Graphics Server SDK	495	455
OOP/C++ ADD ONS			KnowledgePro Windows	249	229
C++ Science & Engineer	999	895	MS Windows V3.1	150	125
M++	295	279	Multiscope Win. Deb.	379	315
Zinc Interface Lib. w/src.	500	485	ObjectVision by Borland	150	129
Smalltalk/V	125	85	Quadbase-SQL for Win.	995	949
Tools.h++ w/source	299	279	Quick C for Windows	199	149
OTHER PRODUCTS			Realizer	395	269
Alpha RPL Companion Upgrade	595	99	Smalltalk/V	500	399
CBX-paralink	80	75	ToolBook	395	349
FastBack Plus	189	159	Visual BASIC	199	165
			WindowsMaker Prof.	995	895

THE PROGRAMMER'S SHOP 1-800-421-8006

All prices subject to change. International prices will vary.

National Accounts: 800-446-1185 Fast Faxes: 617-740-0025

And MORE!...

- DOS, Windows, OS/2 and UNIX tools – for every major language
- FREE, comprehensive buyers guides
- Instant, on-line product literature with *FastFaxts!*
- International Support



Intel 386/486 C Code Builder by Intel Corporation

Open Intel's new 386/486 C Code Builder™ Kit. And tear into the increased memory and performance of 32-bit DOS protected mode. Inside, you'll find everything you need to develop 32-bit applications. That means you get a Microsoft and ANSI compatible C Compiler and Libraries, Linker, Librarian, Make Utility, and Source Level Debugger. We've even included a DOS Extender that's DPMS-compliant. Compliancy that enables easy migration to Windows from Microsoft. No royalties to pay.

LIST: \$695 **PS Price: \$579**
FastFaxts 2799-028

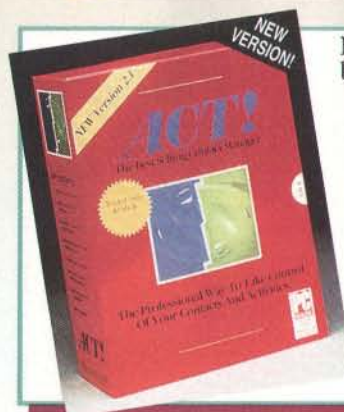

New Act! 2.1 by Contact Software

The Professional Way to Manage Your Contacts and Activities. ACT! the best-selling contact manager, is a powerful, yet easy-to-use program that automates the contact and calendar information of business people. ACT! provides the database, scheduling and work processing functions needed by anyone with business contacts. Available in Single-User and Network versions, ACT! is PC Magazine's "Editors' Choice" for contact management software.

LIST: \$395 **PS Price: \$329**
FastFaxts 2116-001

What is FastFaxts?

Access literature on any of our products via FAX machine. **FREE!**

Call: 617-740-0025 from any fax phone!

Follow the voice computer's instructions and enter your product's code number. Then await your instant print out of product literature.



"I'm tremendously impressed by *Layout*, by its ease of use, by its capabilities, by its price. Put down this magazine and order *Layout* now. It's that good!"

That's what *PC-AI Magazine* said about *Layout*, the only tool that lets you build DOS programs by manipulating

objects on screen -- without writing code. Not just simple programs, but complete, heavy-duty GUI applications. And when you're done, *Layout* creates stand-alone .EXE,



C/C++ (MS & Borland!), Pascal, or QuickBasic code. *Layout* has over 100,000 users, more than 30 add-ons available (including support for simultaneously building DOS and Windows programs), and costs only \$299.95.

Call 800-424-6644 for a free *Layout* Sampler Disk.

Objects, Inc.

Objects, Inc.
99 Rosewood Drive
Danvers, MA 01923
508-777-2800
FAX 508-777-0180

LIST: \$ 300

PS Price: \$239

FastFaxts 3324-001

THE PROGRAMMER'S SHOP 1-800-421-8006

National Accounts 800-446-1185

DEUTSCHLAND
Telefon: 0231/1768-0
Telefax: 0231/1768-16

ITALIA
Telefono: 02-48.01.11.11
Telefax: 02-48.01.11.07

90 Industrial Park Road, Hingham, MA 02043 • Canada 800-446-3846 • Mass. 617-740-2510 • FAX: 617-749-2018
Credit card orders processed only when product is shipped. All prices subject to change. International prices will vary.



BY692



MAKING KNOWLEDGE PAY

To compete in today's fast-moving business environment,
organizations must create a culture of shared understanding

CHRISTOPHER LOCKE

It's common to hear someone say that technology is changing the way people do business. On the surface, this seems like a self-evident truth. On closer scrutiny, however, you discover that unexamined belief in this hackneyed sentiment gives rise to innumerable high-tech tools that force people to work in unnaturally constrained ways according to old (and possibly obsolete) assumptions. Inverting the cliché yields a closer approximation of the truth: The way people do business is beginning to elicit radically new technological responses.

There is always a reciprocal relationship between how business is pursued and the technological tools used to pursue it, and this reciprocity can lead to fruitless chicken-and-egg arguments about what influenced what first. Practically speaking, however, most organizations design and implement software systems based on obsolete principles stemming from the bygone era of mass production. This article examines how technology is finally responding to how you do business today.

The Way We Were

In the days of large, stable, and chiefly domestic markets, there was little pressure to innovate. A product might remain essentially unchanged for years or even decades. Because companies churned out enormous quantities of these products, the processes that controlled their manufacture could be "rationalized" and eventually automated. A significant economy of scale resulted: The more volume increased, the more unit costs dropped. Because knowledge of the design and control of these repetitive assembly-line procedures tended to be concentrated at the top of organizations, the time that was needed to train workers was radically reduced. In the typical mass-production scenario, workers could be taught in minutes or hours to perform tasks that they might repeat for a working lifetime.

The downside of this cost-benefit is often called *deskilling*. In mass production, fewer people understood what they were doing. The worker who inserts the bolt, thought Henry Ford, should not be the same worker who tightens the nut. During the

period sometimes known as the second industrial revolution, pride in craftsmanship and deep learning through apprenticeship quickly gave way to an automatism in the performance of work. A spirit of fatalistic resignation and often alienation came to characterize the American workforce. Although workers resented being treated like appendages of the new machines, their companies were thriving on the rising output. As computer-controlled automation became available, companies began to replace workers with increasingly "intelligent" systems.

By the early 1970s, the dawn of truly global competition conspired to break this rising spiral of automation, higher output, and lower costs. Asian and European companies started to capture significant portions of markets where American companies had previously enjoyed unchallenged hegemony (e.g., consumer electronics, automobiles, chips, and computers). Today, markets are irreversibly fragmented, product diversity is far greater, production runs are correspondingly shorter, and economies of scale are getting very hard to find. Mass production is dead, but many companies have been slow to appreciate this as a permanent change. In fact, the change represents a seismic paradigm

Making Knowledge Pay

BY CHRISTOPHER LOCKE

244

The New Age of Documents

BY JOHN E. WARNOCK

257

Electronic Books

BY LOUIS R. REYNOLDS AND

STEVEN J. DEROSE

263

Search and Retrieval

BY EARLENE BUSCH

271

SGML Frees Information

BY HAVILAND WRIGHT

279

Resource Guide:

SEARCH AND RETRIEVAL SYSTEMS

287

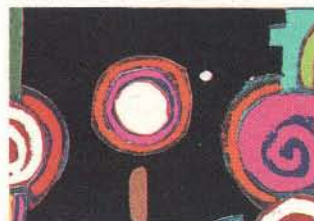

shift, and the lag in corporate perception has cost billions of dollars in lost markets and widespread unemployment.

Organizations and Software

What does this whirlwind historical tour have to do with the software that you use to manage your business? Everything. "Intelligent machines" are great at controlling relatively stable mass-production operations, but they require quotation marks because they are incapable of innovation. This is bad news for certain wishful thinkers. Innovation is the key to global competitiveness, and innovation requires learning. The fatal catch is that only human beings are capable of learning in any meaningful sense. Only through the firsthand experience, deep process insight, and rapid adaptability of their people can organizations meet the fundamentally changed expectations of world markets. You don't need more questionably intelligent automation; you need tools that will support, not attempt to supplant, human understanding.

The central-mainframe-and-master-database business model has long assumed that accurate and adequate knowledge resides only at the top of organizations and that only this privileged knowledge can command and control a hierarchy of business units and their constituents. That assumption has been seriously challenged over the past decade with the swift proliferation of personal computers, workstations, and LANs. Still, the mother-of-

all-databases mentality lives on in the design of many software tools, and a lot of managers continue to believe that only by carefully controlling the contents of database fields can they define, circumscribe, and confer legitimacy on a subject. But where fixed-field items (e.g., employee number, pay rate, and mother's maiden name) are used to delimit a person's identity and worth, something irreplaceable is being lost.

Where's the Knowledge?

The problem is that people in business are no longer sure of what it is they need to know. The challenge is not to increase efficiency, as in the heyday of mass production, but to deepen vision. A number of companies that automated to the point of "lights-out" operation have since had their lights turned out by Chapter 11 proceedings—not because they weren't productive, but because they were offering the wrong products. So, what is the right stuff? A bigger question is, Who knows?

In the mid-1980s, many hoped that AI would revive the recurrent management dream (or nightmare) of central control over increasingly complex operations. By capturing essential knowledge and automating the rules by which it was to be applied, AI promised to replicate (or replace) the human intelligence previously required to perform high-level work. But the world had another idea.

To be effective, so-called "expert systems" largely require a stable world (a *well-bounded domain* is the preferred jargon), one that has already made up its mind, so to speak. Although such stability may have characterized the era of mass production, it has long since been swept aside in most environments by an unrelenting dynamism. Had AI been available to Henry Ford, it might have worked miracles. Today, it simply doesn't work.

Knowledge is not fixed, nor is it the exclusive province of an organizational elite. Despite years of deskilling automation, intimate knowledge still resides with people close to critical production processes—regardless of whether their collars are blue or white or whether they produce washing machines or financial reports. Genuine knowledge has two irreducible aspects: It is seldom structured in the form of fixed fields or dependable rules, and it's social (i.e., it is distributed as shared understanding among human groups that often have little respect for artificial organizational boundaries).

The articles in this State of the Art section focus on new kinds of tools for articulating, organizing, and sharing such bona fide knowledge. For the most part, they

deal with unstructured information: language. Although the outline of a book is definitely a structure (and a useful one), it doesn't constrain the content that can be communicated in the same way that a database's record structure limits the content of prespecified fields.

A note of explanation is in order here. It's easy to equate language solely with text, and, indeed, many of the tools described here deal with textual information. However, many can also accommodate graphics, sound, and video—the full range of multimedia communication. What distinguishes *language*, in the sense the word is used here, is not mode but modus. Language is narrative; it enables the telling of stories. As John Seely Brown of Xerox Palo Alto Research Center has pointed out, such stories are the real expert systems that enable organizations to function effectively (see "Research That Reinvents the Corporation" in the bibliography).

Tools such as databases, spreadsheets, and expert systems may be useful for massaging data or automating routine procedures, but they are poor vehicles for telling stories. The data these tools contain is not readable in the sense that a story is readable. How much plot development can you get out of a field descriptor, a cell formula, or an if/then rule? Also, these tools impose so rigid a context that there is no room for readers to interpret, amplify, reshape, and retell their contents—the means by which stories not only are propagated but often evolve into something unsuspected at their inception. This nearly genetic potential for recombinant mutation through social transmission points to the enormous value of work-related stories: They express a collective imagination that is often far greater than the sum of the imaginations of those retelling the stories.

This living knowledge emerges as people share their perspectives and defuse their collective prejudices, blind spots, and unfounded assumptions. This collaborative exploration cannot be automated or controlled by the old mechanisms of organizational management (i.e., the hierarchy, the chain of command, the delivery of cut-and-dried marching orders).

Although the two are frequently confused, knowledge differs from data in that it evolves along a critical path from story to culture to organization to technology. Too many companies have this natural selection process backwards, and they are drowning in a sea of high technology without insight or content, often producing products and services of abominable quality. This is precisely why you hear so much about concepts such as workforce empowerment, employee involvement, self-

BYTE ACTION SUMMARY

Knowledge, so crucial to innovation, must be distributed throughout organizations, not concentrated in their executive suites. Companies that want to survive in the new competitive environment need to listen closely to the stories their people tell in the course of their work and to find ways to broaden that discourse. This State of the Art section offers suggestions for advancing such an agenda.

TOP-RATED!

BORLAND'S PARADOX = POWER + EASE

Unlike ordinary databases, only Borland's Paradox® 3.5 offers you advanced database power and ease of use. No other database puts your data to work for you faster.

Query By Example

Query By Example (QBE) is by far the easiest way to search for data.

Now you can find exactly the information you need without complex code or confusing procedures. Simply checkmark and enter the examples of data you want and get an immediate answer.

Multi-table forms and reports

Paradox 3.5 solves your data entry and presentation problems utilizing multi-table forms and reports. Combining data from various tables is simple and quick.

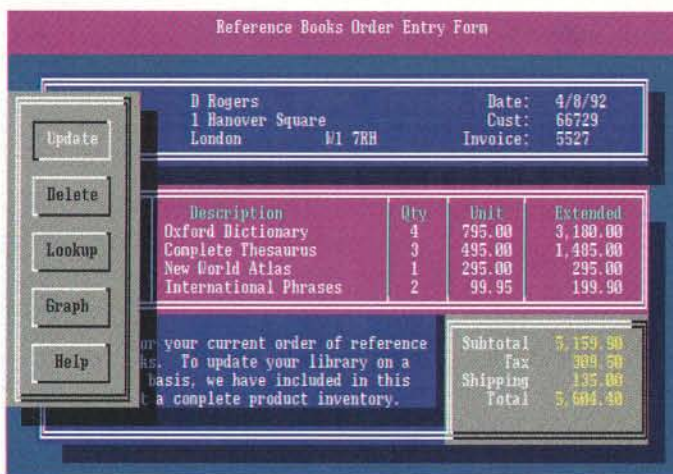

PAL: A powerful developer language

Paradox Application Language (PAL™) lets you access programming features and tools that equal the most sophisticated programming languages. Includes a debugger, editor and a full-featured development language to build the most powerful database solutions.

Paradox SQL Link and Engine†

With Paradox SQL Link, users can access remote data stored in

Multuser network ready

Paradox 3.5's intuitive menu systems give you access to the information you want without any hassle. Setting up and modifying a table is simple. Paradox 3.5 is your departmental solution. Simply add users with Paradox LAN Pack to Paradox installed on a file server and *automatically* get complete multuser record and file locking on the same data—built-in!

SQL servers. Plus, the Paradox Engine provides C, C++ and Pascal programmers with an Application Programming Interface (API) so users can access Paradox data from your custom programs. Put the power + ease of Paradox to work for you today.



60-day, money-back guarantee!

To order Paradox, see your dealer or call 1-800-331-0877, ext. 5846

#1
Tied
in Customer Satisfaction
Among Business Users*

J.D. POWER AND ASSOCIATES*

1. Borland
1. WordPerfect
3. Lotus
4. Microsoft
5. Claris
6. Aldus



March 1992
Paradox 3.5



May 28, 1991
Paradox 3.5†



May 1991
Paradox 3.5

Paradox has won virtually every database award since its introduction.

B O R L A N D
Software Craftsmanship

*J.D. Power and Associates 1991 Computer End User Satisfaction Study for Application Software Publisher: Phase IV: Business End User Summary. Responses from Business End Users at 4,396 business sites. †Reprinted from PC Magazine, May 28, 1991. Copyright © 1989 Ziff Communications Company. ‡Paradox SQL Link and Paradox Engine sold separately. Software Digest is a registered trademark of NSTL, Inc. Copyright © 1992 Borland International, Inc. All rights reserved. All Borland product names are trademarks of Borland International, Inc. BI 1546

Circle 14 on Inquiry Card (RESELLERS: 15).

Collaboration '92

Collaboration '92, a new conference dealing with many of the issues raised in this article, will be held June 1-3 in San Francisco, California. I will be present as chair of the conference, and Haviland Wright and Louis R. Reynolds, whose articles appear in this State of the Art section, will also be there.

Subtitled "Learning to Team, Teaming to Learn," the conference will feature keynote talks by Michael Schrage, author of *Shared Minds: The New Technologies of Collaboration* (Random House, 1990), and Charles Garfield, author of *Second to None: How Our Smartest Companies Put*

People First (Business One Irwin, 1991). Other speakers include John Seely Brown, director of the Xerox Palo Alto Research Center; Etienne Wenger, research scientist at the Institute for Research on Learning; and Terry Winograd, professor of computer science at Stanford University.

These and many other speakers from consulting organizations, Fortune 100 companies, and the national business media will address the factors influencing the paradigm shift that has taken place in corporate perspectives and priorities in recent years. They will put current organizational change into historical context by examining why pre-

vious corporate structures and styles of management are inadequate to meet present demands, and they will describe the advantages accruing to organizations based on human initiative, local autonomy, and collaborative learning. These difficult but necessary cultural changes occurring in business organizations can be either nurtured or obstructed, depending on the computer and communications systems adopted. This intersection of corporate culture and information technology constitutes a primary theme of the conference.

Collaboration '92 is being organized by the Graphic Communications Association (Alexandria, VA).

directed work teams, participatory management, and concurrent engineering. Organizations critically need knowledge they can no longer supply from the top down.

Ironically, relinquishing power to the people is also the major factor fueling a new breed of knowledge-based high-performance business organizations. Such organizations do exist, and they will be highlighted at a conference that explores how technology can help organizations come to grips with the new realities of doing business (see the text box "Collaboration '92" above).

If the idea of corporate story telling still seems farfetched, consider some of the channels through which you practice the art every day: when you use the telephone or when you interact with people you meet at the copier or the fax machine. And these are only the older trade routes in the story traffic. The social concept of networking is now almost inseparable in some quarters from the physical networks that support it: LANs, internets, and electronic conferencing systems—even sneakernets play a significant role in networking. Marriages are being announced every day between computers, fax machines, modems, cellular phones, phone companies, cable networks, and electronic information providers. The distinction between hard copy and soft copy is rapidly blurring.

Knowledge Sharing

I recently installed a fax modem in my computer that enables me to do some in-

teresting things. I can capture a page from a book using my copier and then fax the copy to myself. Using optical character recognition technology, I can convert the fax image to machine-readable text. Voilà, I've got a fairly intelligent "distributed" scanner.

Taking advantage of the modem's Send facilities, I can dial up the Well (an on-line conferencing system in California) using Sprint's or CompuServe's carrier services and transfer the newly captured file from my PC to my remote Unix account. I can then post the file in a conference that I host there, where it will be read—and downloaded—by people logging in from around the globe.

I can also send the file via E-mail to my editor at BYTE with the comment, "Hey, what do you think about including this material in the article we talked about?" If the piece fits, the editor can download the mail file to BYTE's composition software, and you might read it on these pages as hard copy. But, in between, it has been as "soft" as it gets. On the other hand, my editor may send return E-mail saying that the topic was covered thoroughly three years ago.

In the meantime, on the Well, the original information has probably generated responses and caused an exchange of ideas and information on related topics among other members of the conference. Conversely, the information might be reposted in a BIX discussion. These opinions, annotations, and pointers to related material,

whether in print or on-line, constitute a powerful virtual conversation among people who may never meet face-to-face.

This form of networked conversation is the electronic analogue of the proverbial water-cooler discussion in which serious organizational matters are often communicated and sometimes even resolved. Part of it is trivial banter, but another part of it is significant information that individuals might never be aware of without this exposure to a larger community of loosely associated potential collaborators. The collective network is like a "Big Mind" in which our personal knowledge and intelligence is a single node. And big thoughts are brewing there—a kind of massive parallelism with a human face. This point is critical, because without the social banter and human connections, none of the rest is possible. People don't interact for very long in fixed-field datapoints.

What happens to all the information that you collect—the faxes printed on sheets of greasy low-resolution paper, the disks crammed full of on-line database downloads, and the overflowing E-mail boxes? Usually it winds up in the directory structures on your personal computer or workstation. These structures represent attempts (usually fairly primitive) to create personal classification systems—think of the Dewey decimal system on a small scale (see "The Dark Side of DIP" in the bibliography). But because nobody has all the answers, it's becoming increasingly necessary to share this "personal" information

While Our Competitors Are Diligently Trying To Emulate The SummaSketch® II...

We Proudly Announce SummaSketch II *Plus*

The world's best selling, most emulated, most acclaimed desktop tablet just got better. We've taken SummaSketch II, the industry standard, and added several new features to create a tablet that is, unquestionably, the world's best.

Unlike some competitors, we put everything in the box—4-button cursor and 2-button stylus (or 16-button cursor), interface cables and a utilities diskette with Windows® 3.0 and ADI® drivers. Plus we've added things like 2000 lines per inch resolution and 10 mil accuracy—standard. Plus the fastest, easiest set-up and configuration procedure. Plus an offer for a free AutoCAD® or CADKEY® Master Template (a \$245 value). Plus software compatibility



with over 400 programs, and hardware compatibility with PCs and Macintosh®. Best of all, it's still 100% pure SummaSketch—the editor's choice, winner of every major editorial accolade for graphics tablets. And the people's choice, with well over one-half million sold to demanding computer graphics professionals.

**Every
decision**

should be this easy. In fact, the only tough decision is which Plus to choose: 12" x 12" or 18" x 12" Professional. For literature, or the name of your local dealer, call 1-800-729-7866. For technical information call 203-881-5400.



Summagraphics®

Every decision should be this easy.™

© 1992 Summagraphics Corporation, Seymour, CT 06483. All rights reserved.

Circle 158 on Inquiry Card.

with one or more collaborative work teams, whose members may be dispersed throughout a large corporation or belong to entirely different organizations dispersed over several continents (see *Enterprise Networking: Working Together Apart* in the bibliography).

Community Tools

How do you share your personal information? Initial responses to this problem include the construction of shared network-directory structures, which attempt (though they often fail) to reflect a consensus about the categories of information they are designed to organize. A more systematic and comprehensive response is the adoption of concept-oriented information retrieval systems (see "Search and Retrieval" on page 271).

One such system is Topic from Verity. Topic enables the construction of *semantic networks*, complex webs of ideas and their interrelationships. You can navigate the concepts along relational linkages until you find something that seems relevant and then ask for all the documents the system has on that subject. Because these conceptual maps are independent of the base data (usually free-text information having no consistent format), you can think of this approach as a kind of virtual hypertext.

It's possible to empty a Topic textbase of its documentary contents; reindex a completely new, but substantively related, set of documents using the same topic nodes and links; and retain the fundamental relationships among the base information objects. This method differs significantly from the explicit embedding of hypertext links in documents.

Explicit hypertext links are not an inferior approach by any means. Often, significant relationships cannot be deduced from conceptual proximity alone. A wide range of document types (e.g., manuals, E-mail, legal contracts, and on-line database downloads) can all be intimately related to a single project. Relying on the co-occurrence of key words to link heterogeneous objects might not always work. Hypertext systems enable such objects to be bound together at their point of intersection (e.g., a reference to a contract in a letter).

Another form (what I call *structural hypertext*) takes advantage of the logical organization of many documents into sections, chapters, paragraphs, figures, and tables. With this method, if the table of contents is well designed, people can browse at a high level and then drop down into the relevant details. DynaText from Electronic Book Technologies (see "Elec-

tronic Books" on page 263) provides for both types of hypertext, as well as Boolean queries against fully indexed document collections.

Early on, many systems that deal with unstructured information run up against a formidable barrier: proprietary data formats. For instance, all commercial word processing programs implement some form of markup strategy by which a writer indicates centered headings, bold or italic text, indented paragraphs, enumerated lists, and so on. The way this markup is encoded differs for almost every product on the market. The result is that one brand of word processing software cannot read files created by another. One way around this is to work in a text editor that uses only the ASCII character set. The original Unix facilities (e.g., `vi`, `nroff`, and `troff`) took this approach.

The format/markup problem also pertains to graphics, database, spreadsheet, and just about any other kind of file you can think of. Providing needed information to workgroups when they require it has become a major challenge in most organizations. This is especially true in companies attempting to break down the organizational walls and functional "chimneys" that separate people who critically need the benefit of each other's experience.

Platform Bridges

One approach to solving this problem is the use of software products that integrate information from multiple sources, irrespective of the vendor. Microsoft Windows and Macs accomplish this by bumping the proprietary demand up a notch: You can share information as long as your applications are designed explicitly for these environments. Sharing information between Microsoft Windows and Macs is another story. Although Bill Gates's vision of "information at your fingertips"—or still farther out, John Scully's notion of a "knowledge navigator"—is not a universal reality, vastly improved transmigration of data is certainly looming on the horizon. Carousel, a new document-publishing technology from Adobe Systems, is explicitly designed to migrate documents between disparate platforms while retaining much of the original look and format (see "The New Age of Documents" on page 257).

In the manufacturing arena, CIMLINC has developed an environment called Linkage, which allows information from widely distributed network sources and a broad array of proprietary software packages to be brought together in one form on a Unix workstation or X Window System

terminal screen. In addition to textual information of all kinds, these forms can present live vector graphics, raster images, information returned from SQL (Structured Query Language) queries against multiple databases, and near-real-time video images captured with a fast frame grabber. These forms can be scripted by people associated with the production processes, even if they have little or no programming knowledge.

By assembling the information in one place, these screens can convey the core information required for self-directed work teams to execute—and continuously improve on—extremely complex manufacturing tasks. Most important, perhaps, this environment is a two-way street: It not only delivers design and manufacturing engineering specifications to the shop floor, but it also elicits feedback on potential problems and process improvements from people intimately familiar with manufacturing operations.

This kind of cross-functional collaboration is at the heart of what in some circles is called *concurrent engineering*—simultaneously designing products and their associated manufacturing processes with early input from all groups that have relevant knowledge, regardless of where they are located in the organization, either physically or hierarchically. With experienced people in the loop, a company can begin to learn through such systems and greatly expand its organizational memory. In this light, the so-called *knowledge acquisition bottleneck* (AI's great nemesis) can be seen as the kind of problem typically generated by fundamentally flawed design principles.

Structuring Information

Although Linkage relies on a wide variety of data-type translators to integrate this broad bandwidth of manufacturing information, a more general solution is waiting in the wings and is about to make a serious debut in corporate computing in this country. This solution goes by the daunting designation of Standard Generalized Markup Language. SGML is a well-established ISO standard and has been mandated by the Department of Defense as the markup methodology to be used in all aspects of the far-reaching Computer-aided Acquisitions and Logistics Support program. SGML has also been accepted by the Air Transport Association (which represents airframe manufacturers) and a growing body of supporters in many industries, government agencies, and service organizations throughout the world.

SGML lets you describe the essential

Take The Lead!

Isn't it time you experienced the benefits of object-oriented programming?

You can with DataFlex 3.0.

DataFlex's comprehensive 4GL, robust class libraries, object-oriented program generators and proven database management system provide you with a complete library of tools for application development.

Generating complete object-oriented programs is as easy as clicking on AUTOCREATE in DataFlex's menu system. Utilizing DataFlex's many other language features lets you create fully customized CUA applications.

Experience faster development, easier maintenance, re-usable code and better looking applications now with DataFlex 3.0 for \$795. If you currently use another 4GL or programming language, the cost is only \$125,* a savings of \$670.

The benefits of object-oriented programming are available now. Don't get left behind.

Take the lead...with DataFlex!

Call 1-800-451-FLEX for complete DataFlex information and the dealer nearest you.

Australia 61-3-699-7044

Austria 43-662-658-2237

Belgium/Luxembourg 49-61-727-5014

Brazil 55-11-872-9266

Canada 416-226-2191/416-785-5041

Chile 56-2-231-7015

Denmark 45-45-78-4545

France 33-1-47-241-961

Germany 49-61-727-5014

Hong Kong 852-311-7922

Italy 39-587-422-022/39-51-437-025

Japan 81-480-856-565

Mexico 525-545-6327

Minsk 7-0172-236797

Moscow 7-095-4342060

Netherlands 31-74-555-609

New Zealand 64-9-772-701

Norway 47-2-559-966

Singapore 65-775-5588

Spain 34-1-402-2298

Sweden 46-300-19530

Tallinn 7-0142-238035

United Arab Em. 97-12-331-885

United Kingdom 44-71-729-4460



DATA FLEX 3.0

Object-Oriented 4GL
Application Development Environment
DBMS

DATA ACCESS

C O R P O R A T I O N

14000 SW 119 Avenue
Miami, Florida 33186
305/238-0012

For information via CompuServe: GO DAC

*A limited time offer, expires 06/30/92. Participants must supply the first page of a manual or an original disk from their language or database program.

Prices may vary by country.

© DataFlex is a registered trademark of Data Access Corporation.

Circle 93 on Inquiry Card (RESELLERS: 94).

Silicon Graphics

Kingston's memory upgrade products offer you a variety of solutions for enhancing Silicon Graphics workstations including:

Personal IRIS

- 4D/30, 35
- 4D/RPC Indigo
- 4D/20, 25

Professional IRIS

- 4D/40, 50, 70, 80, 85

Power IRIS

- IRIS Crimson
- 4D/120, /2xx, /3xx, /4xx

All Kingston memory enhancements are individually tested, fully warranted and 100% compatible.

For information on our workstation products call:

1-800-835-2545

For PCs call 1-800-835-6575

Ph. 714-435-2667

Fax 714-435-2618

East Coast 516-673-6300

Manufactured by



17600 Newhope Street
Fountain Valley, CA 92708

Memory Enhancements

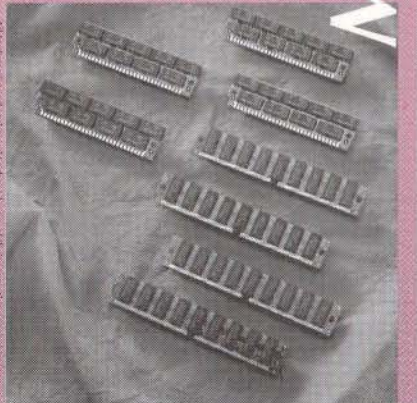

MAKING KNOWLEDGE PAY

features of the most complex documents without becoming a hostage to the proprietary standards imposed by most software vendors. A document created in or converted to the SGML format can be output in many forms on many types of systems. Attributes such as font size, typeface, and method of emphasis (e.g., bold, italics, and small caps) can be quickly and globally changed to suit circumstances.

Far more important, you can describe, or mark up, the structure of a document—the logical organization of its constituent elements (e.g., chapters and sections)—in such a way that the description is never lost, no matter what target systems the document ends up on. Such documents can be transmitted in their source form over networks or can be exchanged with dissimilar systems. Later, you can reconstitute the documents in any format you desire. Because source documents are pure ASCII, a single text-retrieval engine can index, search, and retrieve them with great facility, even if you used several software products to create them. However, any software that creates, converts, or interprets such documents must adhere to the same nonproprietary SGML standard. The payoff that most industries are seeking is universally shareable information (see "SGML Frees Information" on page 279).

The Big Picture

There is another, greater payoff to be obtained from using the technologies outlined in this article. Although the benefit is hard to nail down and evaluate in terms an accountant might immediately appreciate, it promises enormous strategic advantage: the ability to create organizations capable of learning from their hardest-won insights and most egregious errors. Paradoxically, this potential advantage is inextricably linked with the perceived drawbacks of these same technologies: None of the technologies are particularly easy to implement. Concept-based text retrieval, hypertext, document assembly, SGML, and even CIMLINC's applications synthesis tools are simply not plug-and-play sorts of things. All require knowledge they cannot themselves supply. This is simultaneously their best and worst aspect: They make people think.

The search for push-button solutions has yielded little of lasting value. Promises of intelligent systems have often been responsible for the perpetration of grotesque stupidities. There is no magical, sacrosanct, or immutable knowledge that can be packaged and delivered to the corporate doorstep to protect organizations from their own ignorance. Ignorance results solely from a failure to learn—a weak-

ness for which there is no known technological cure. The deskilling that resulted from much "advanced" automation serves as a good example: Corporations' ability to learn quickly atrophied when they didn't seem to care any longer what workers knew. Management only wanted to know enough to automate jobs away.

Companies facing the intense pressures of international competition must begin caring again—and soon—about what everybody knows. They must encourage the open exchange of information by every means possible and forge new corporate cultures based on collegial discourse and collaborative exploration. This isn't easy, but it is necessary. Without such thoughtful discourse and engaged collaboration, innovation comes to a halt.

The tools described in the following articles substantially increase access to a multifaceted constellation of narrative information resources. They can enable valuable old stories to be told through new channels, and new stories to emerge where, for most organizations, only silence has reigned since the second industrial revolution. Listen to what the people are saying; you can't afford not to. For good or ill, a third revolution is in the air. ■

BIBLIOGRAPHY

- Brown, John Seely, and Paul Duguid. "Organizational Learning and Communities-of-Practice: Toward a Unified View of Working, Learning and Innovation." *Organization Science*, February 1991.
- Brown, John Seely. "Research That Reinvents the Corporation." *Harvard Business Review*, January-February 1991, p. 102.
- Grenier, Raymond H., and George S. Metes. *Enterprise Networking: Working Together Apart*. Bedford, MA: Digital Press, 1991.
- Locke, Christopher. "The Dark Side of DIP." *BYTE*, April 1991, p. 193.
- Sproull, Lee, and Sara Kiesler. *Connections: New Ways of Working in the Networked Organization*. Cambridge, MA: MIT Press, 1991.

Christopher Locke is director of corporate communications at CIMLINC. He worked on the Fifth Generation Computer Systems project, the Japanese government's primary AI research initiative; served as director of corporate communications for two AI firms, Carnegie Group and Intelligent Technology; and was director of industrial relations for the Robotics Institute at Carnegie Mellon University. You can reach him on BIX c/o "editors" or on Internet at clocke&well.sf.ca.

There are two ways to do your math. Drag. Click-n-drag.

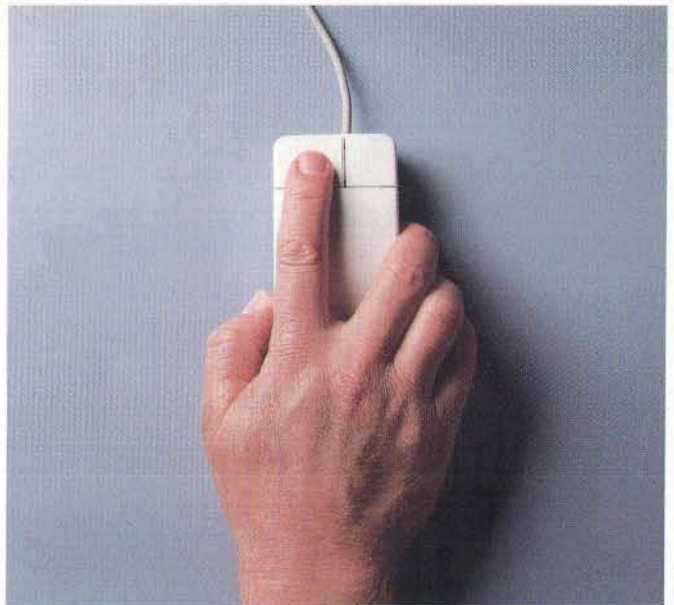
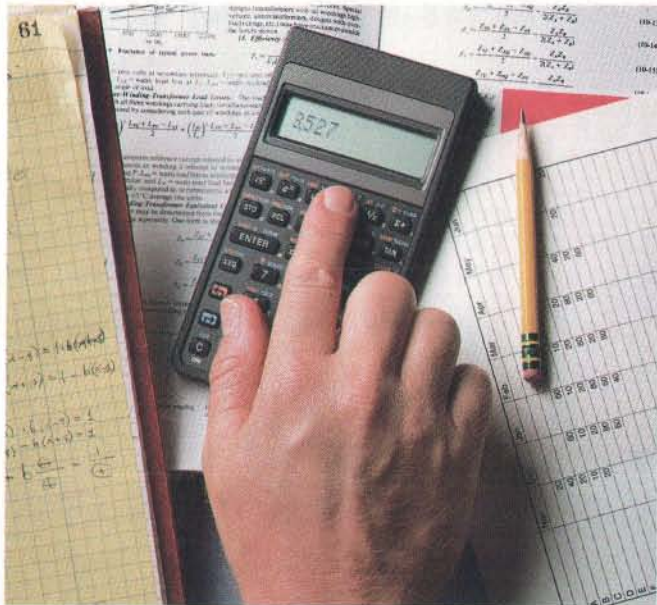

Solve problems fast with Mathcad 3.1.

Don't let calculations keep you from getting work done. Cruise through problems with the math package that's fast, all-purpose—and easy: Mathcad 3.1.

The one-step system.

Mathcad 3.1 is much more than just a number-cruncher. It's an integrated math

calculation capabilities. So you can do any integral, Taylor series, or infinite sum with click-n-drag simplicity.

Done calculating? Mathcad prints out presentation-quality documents complete with equations in real math notation.

Give your math a hand.

To help you work even faster, Mathcad 3.1 includes a Standard Electronic Handbook for instant access to hundreds of standard formulas, useful data, and commonly-used equations. Ready for interactive use, just click-n-paste them into your work. Without ever opening a reference book.

And now there are three new optional Electronic Handbooks* created with the leading publishers of technical handbooks: The CRC Materials Science and Engineering Handbook, Machine Design and Analysis from McGraw-Hill, and the Mathcad Treasury of Methods and Formulas. Plus optional Applications Packs with modifiable templates for all major engineering and science fields.

160,000 people already rely on it.

Mathcad's the best-selling math software because it gets results. Here's how:

- Easy to learn and use Microsoft® Windows or UNIX interface
- Easy to use symbolic calculations
- Standard Electronic Handbook with hundreds of useful built-in solutions



- Optional Electronic Handbooks available
- Differentials, FFTs, cubic splines, matrices and more

- 2-D and 3-D graphics
- Presentation-quality documentation
- Optional Applications Packs with adaptable templates for Electrical, Mechanical, Civil and Chemical Engineering, Statistics, Advanced Math, and Numerical Methods
- PC DOS and Macintosh® versions also available

Free demo disk.

For a FREE Mathcad demo disk, or upgrade information, call 1-800-MATHCAD (or 617-577-1017, Fax 617-577-8829). Or see your software dealer.

* Electronic Handbooks require Mathcad 3.1 and Microsoft Windows 3.0 (or higher) or UNIX.

© 1992 MathSoft, Inc. TM and © signify manufacturer's trademark or registered trademark respectively.

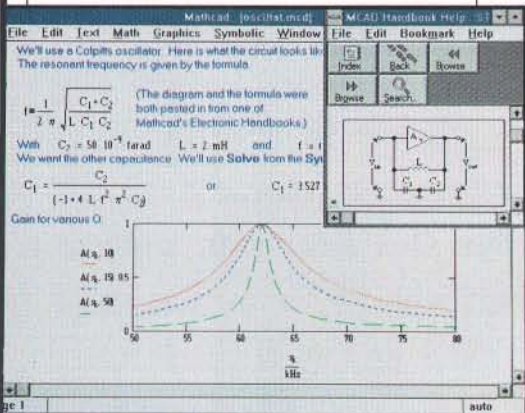
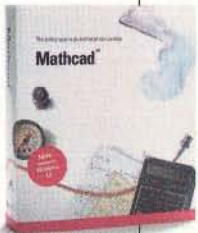

system that performs everything from addition to symbolics—easily and naturally. Because it works the way you think.

Just type your calculations anywhere on the screen—just like a scratch pad—and you're done. Mathcad does the calculating. Updates answers when a variable changes. Graphs in 2-D or 3-D. Even accepts bitmapped graphics. A quick menu pick gives you full symbolic



Mathcad 2.5
3-14-89 issue.
Best of '88
Best of '87

1-800-MATHCAD

The answer is Mathcad®

MathSoft, Inc. 201 Broadway, Cambridge, MA 02139 USA • Phone: 1-800-628-4223 • 617-577-1017 • Fax: 617-577-8829

Australia: Hearn (03) 866 1766; Belgium: SCIA 013/55 17 75; Denmark: Engberg 42 25 17 77; Finland: Zenex 90-692-7677; France: ISE (1) 46 09 24 00; Germany: Softline (0 78 02) 4036; Italy: Channel 02-90091773; Japan: CRC 03-3665-9741; Netherlands: Klaasing 01620-81600; Sweden: AkademiData (018) 24 00 35; Switzerland: Redacom 032 41 01 11; U.K.: Adept Scientific (0462) 480055. In other locations, contact MathSoft, USA.

The new NEC UltraLite SL/20 is the most versatile notebook computer you can buy. And you can put that in writing.

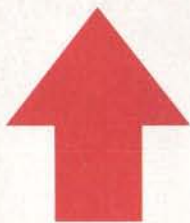

The UltraLite SL/20 is just one of the many innovations NEC has brought to portable computing. Others include the first color laptop, the first portable Docking Station and the first 486SX laptop with 256 colors at 640 x 480 resolution.

Is the pen mightier than the keyboard? In the case of the new NEC UltraLite® SL/20, it's actually a tie. The SL/20 is driven by a powerful 386SL, 20MHz processor with 16KB cache, for enhanced performance. It has an 80MB or 120MB hard drive with factory-installed MS-DOS® and Windows®. And with 2MB of standard RAM (expandable to 8MB), it can handle your most demanding applications. It's extremely lightweight. It provides superior power management, giving you 3 to 7 hours of battery life. And it can serve as a desktop, thanks to an optional, full-function portable Docking Station™. And what does the future hold? A pen. Because soon the SL/20 will offer the option to upgrade to pen computing. So you can forget the mouse. And use your finger or pen to open a window or to access a file. You'll be able to work with NEC's standard UltraDraw™ software. So you can capture signatures. Annotate documents. Do sketches. Or create charts. And you'll be ready for Windows for Pen Computing™* with its handwriting recognition and on-screen editing capabilities. The UltraLite SL/20. It has versatility written all over it.

Call 1-800-NEC-INFO (in Canada, 1-800-343-4418), or NEC FastFacts at 1-800-366-0476, #ULSL20 (857520), for immediate literature.

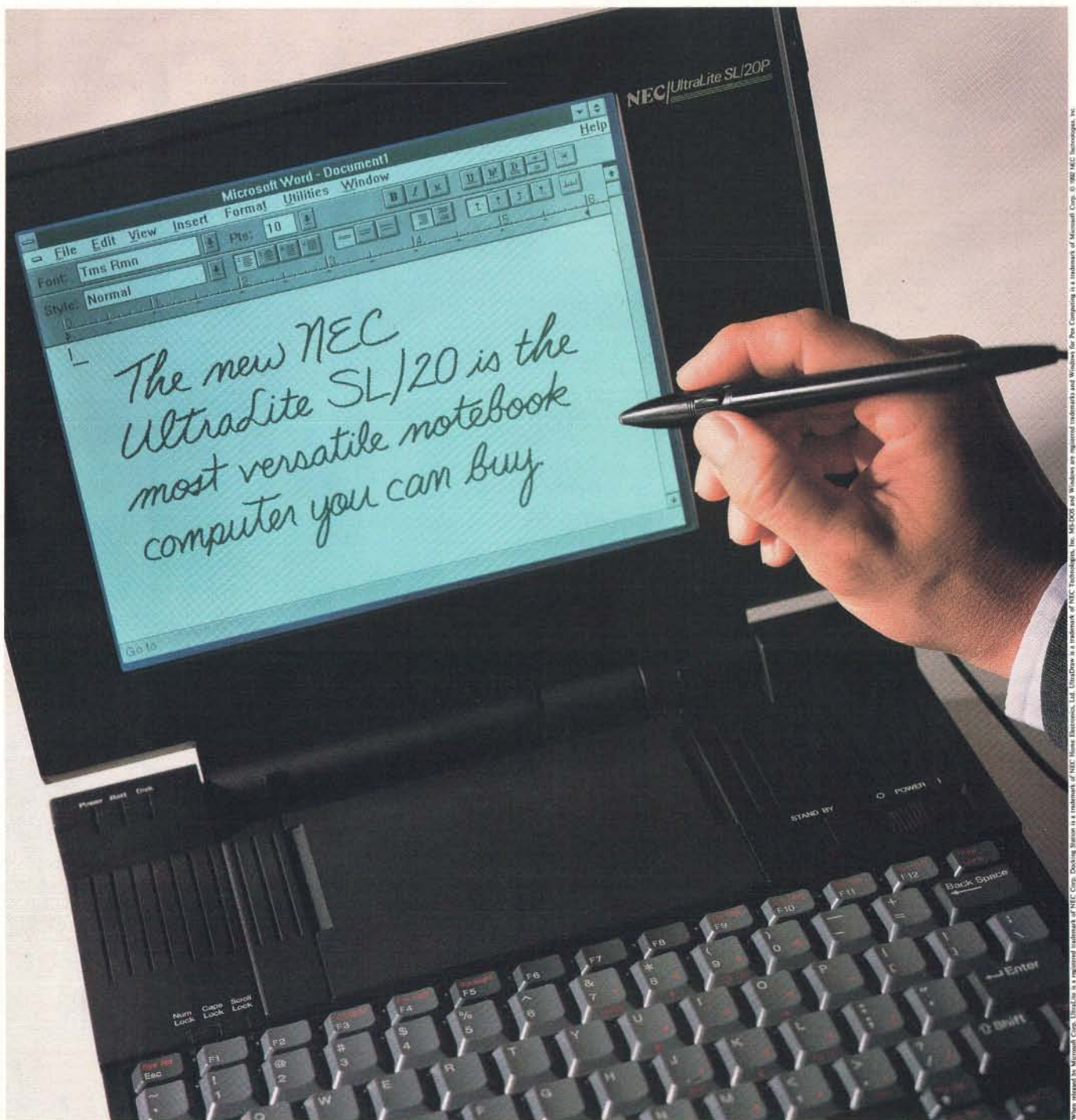

Because  is the way you want to go.

NEC

Circle 134 on Inquiry Card.

When released by Microsoft Corp., UltraLite is a registered trademark of NEC Corp. Docking Station is a trademark of NEC. Other Electronics, Ltd. UltraDraw is a trademark of NEC Technology, Inc. MS-DOS and Windows are registered trademarks and Windows for Pen Computing is a trademark of Microsoft Corp. © 1992 NEC Technology, Inc.

Buy with

Confidence

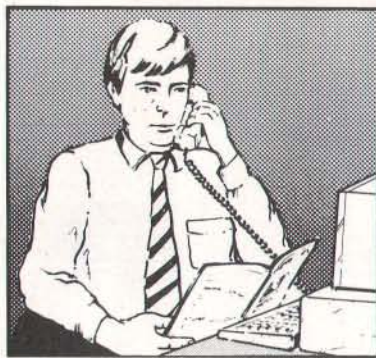

In an effort to make your telephone purchasing a more successful and pleasurable activity, The Microcomputer Marketing Council of the Direct Marketing Association, Inc. offers this advice, "A knowledgeable buyer will be a successful buyer." These are specific facts you should know about the prospective seller before placing an order:

Ask These Important Questions

- How long has the company been in business?
- Does the company offer technical assistance?
- Is there a service facility?
- Are manufacturer's warranties handled through the company?
- Does the seller have formal return and refund policies?
- Is there an additional charge for use of credit cards?
- Are credit card charges held until time of shipment?
- What are shipping costs for items ordered?

Reputable computer dealers will answer all these questions to your satisfaction. Don't settle for less when buying your computer hardware, software, peripherals and supplies.

Purchasing Guidelines

- State as completely and accurately as you can what merchandise you want including brand name, model number, catalog number.
- Establish that the item is in stock and confirm shipping date.
- Confirm that the price is as advertised.
- Obtain an order number and identification of the sales representative.
- Make a record of your order, noting exact price including shipping, date of order, promised shipping date and order number.

If you ever have a problem, remember to deal first with the seller. If you cannot resolve the problem, write to MAIL ORDER ACTION LINE, c/o DMA, 6 E. 43rd St., New York, NY 10017.

This message is brought to you by:

the MICROCOMPUTER
MARKETING COUNCIL
of the Direct Marketing
Association, Inc.
6 E. 43rd St.,
New York, NY 10017

MMC
MICROCOMPUTER
MARKETING COUNCIL
of the Direct Marketing Association, Inc.

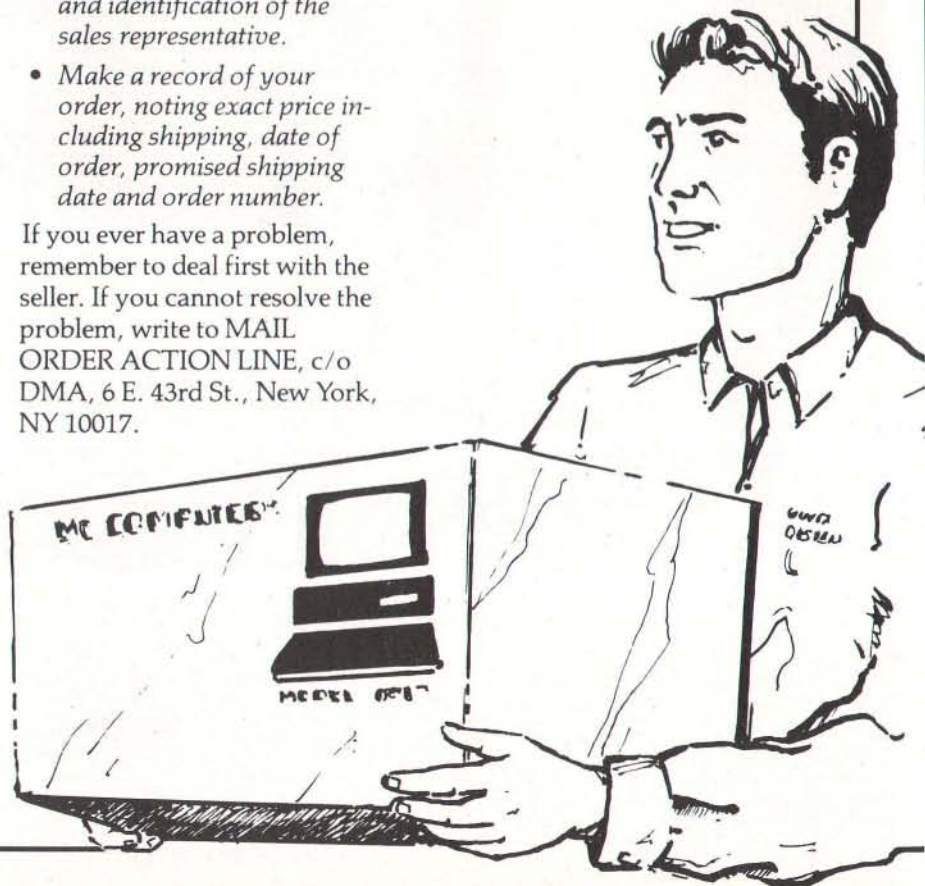

THE NEW AGE OF DOCUMENTS

Imagine a world where the document is the center of things and applications and operating environments are merely tools for document interchange

JOHN E. WARNOCK

Think about how you work. Business professionals spend roughly 60 percent of their average workday dealing with documents—newspapers, newsletters, magazines, financial reports, memos, and so on. Every morning your desk is stacked with all kinds of paper. You read the documents, annotate them with Post-it notes, and forward them to other people.

Computers don't help you read or manage your documents—they create more of them. All the generic applications create paper documents as their final product. Paper is the communication medium. Even if you transmit a document electronically by means of fax, you still probably start with paper.

In today's world, if you wish to communicate a message directly between computers, you most likely use ASCII text, the least common denominator of computer-to-computer communication. You may not be able to reliably communicate more complicated information because the receiver may not be able to read it.

Because of the diversity in computer operating environments, it's hard to imagine that all the machines could communicate with one another. Today's computer world revolves around applications and operating systems. To transmit a document to someone else, the receiver's operating system, application, and resources must be compatible with yours. If the document's form and content depend on several applications, the receiver must have all of them.

If computers could directly and routinely communicate all the documents that computer applications create, communication would be more timely and efficient.

continued



You would use your computer primarily to read, search, and print portions of electronically distributed documents. Documents would become active elements of communication.

As a primary communication tool, computers would become as indispensable as the telephone. Imagine a world where the "virtual document," the active structured information you are communicating, is the center of the computing universe and applications and operating environments are merely tools to enable document interchange.

Technical Barriers

Barriers to document interchange are the result of a highly competitive and heterogeneous industry shaped by proprietary interest groups bent on accomplishing specific goals for their own products. Thus, performance and functional priorities make most applications platform-specific to a degree that blocks easy document interchange. In addition, there are no effective standards for such communications.

Networking companies have helped the situation by enabling standards that allow data interchange between platforms. But *data* interchange is not *document* interchange. You must still manipulate the data with an application in order to create a final product.

Unrealistic requirements for common resources effectively block document interchange. Most large corporations have mixed computing environments, using mainframes, minicomputers, workstations, and personal computers. Groups within a company have different needs and, there-

fore, buy different kinds of equipment. Some people prefer Macs, some like PCs, and others choose workstations.

Diversity may also occur within a consistent operating environment. For instance, Joe may have a black-and-white small-format display with 1 bit per pixel and a computer with limited memory, but his neighbor June has a large, full-color 24-bit display with a system that has lots of memory.

Today, everyone's equipment, systems, fonts, memory, displays, and applications must almost be in lockstep to be able to exchange documents. This may be acceptable for a specific mission-critical application, but it's hopelessly unrealistic for a general business environment.

From time to time, utopian visions of reducing the differences between platforms and moving toward comprehensive compatibility arise. In these visions, everyone moves to a common hardware architecture and a common operating environment. Some people say that Microsoft Windows should be the common environment; others support OS/2; still others say the Mac operating system is the way to go; and workstation vendors choose any of various flavors of Unix.

However, the same competitive priorities that created today's diversity make the chance of adopting a broad single platform essentially nonexistent. The diversity of environments inhibits effective communication among them. And applications tend to use system resources that are incompatible with other environments.

The technical demands of compound documents further complicate the issue:

- Text, graphics, and images all have unique requirements for successful interchange.
- Text interchange must deal with font metrics (the weight and width of each character) that change according to typeface, positioning information, tab settings, line and paragraph breaks, and different character sets and encodings.
- Graphics interchange must accommodate paths, structured graphics, painting operations, graphic state modifiers, device-independent color, and Bézier curves.
- Image interchange must specify data for sampled images, or masks, and parameters (e.g., width, height, depth, color space, and compression).

When documents contain sound and video, as they undoubtedly will, the problems will only increase.

A successful, comprehensive document-interchange solution that can han-

dle the different demands of text, graphics, and images ought to come from document architectures that have a life outside of and across operating-system and hardware platforms. You need an architecture that transcends the boundaries of computer environments and emphasizes the independence and completeness of the *information's* structure.

A Real-Life Experiment

When Adobe Illustrator was under development, one of the design goals was to make the intermediate file format the same as the print file format. Adobe used the PostScript language to describe both the appearance of the printed page and the semantics of the editable objects that the application manipulates. Because the first Illustrator product dealt with simple graphic objects, this ASCII file format was not very complex and had many advantages.

After releasing Illustrator, Adobe discovered that you could easily pass the intermediate files that Illustrator created to other applications. These other applications could insert, scale, and rotate the illustrations in the documents they were producing. Because the illustrations were PostScript language fragments, a receiving application didn't have to understand their contents to print the document. It merely had to pass the fragment to the printer.

Other applications that primarily deal with illustrations (e.g., Aldus FreeHand and CorelDraw) can read the semantics of Illustrator files. As a result, most device-independent clip art is stored in Illustrator format. Illustrator and its output file format have provided a real experiment in document interchange.

With the release of subsequent versions of Illustrator, the complexities of its editable objects have increased. For example, Illustrator 3.0 supports complex text objects, but it does not handle multipaged documents, style constructs, reference constructs, and general image manipulation.

The PostScript language has the potential expressive power to abstract the semantic objects needed to implement a complex editor while preserving the exact layout and appearance of the document. Illustrator 3.0 uses a format that is independent of operating system, hardware, and device and has many of the desired properties of a good document-interchange language. Adobe intends to generalize these concepts to build the foundation of an extensible document-interchange strategy—and hopefully a useful standard.

Standards and Practice

A discussion of most current and past attempts at document-interchange standards

BYTE ACTION SUMMARY

If computers could directly and routinely communicate all the documents that computer applications create, communication would be more timely and efficient. You would use your computer primarily to read, search, and print portions of electronically distributed documents. Documents would become active elements of communication.

Matching Fonts

The handling of fonts is a fundamental problem in document interchange. Consider the following example. Terry produces a document using fonts from the Utopia and Futura type families (see figure A). Terry sends the document over a network to three coworkers, who immediately print the document. The catch here is that none of the people receiving the document have the fonts that Terry used in the original document. There are a number of ways to deal with this problem.

The most common solution would be to print the entire document in the printer's default font, Courier (see figure B). Courier is a monospaced font, so a line of type takes up more horizontal space than it would with a proportionally spaced font (e.g., Utopia). As in figure B, this often results in words running right off the edge of the page. The overall look of the text is also different, so the reader has no sense of how the original document looked.

A second solution would be to substitute available fonts for the original fonts. In Terry's document, Utopia is a serif typeface, and Futura is sans serif. Other serif and sans serif fonts could replace them. However, the metrics of the font differ from one font to the next.

Although this document would be easier to read than the Courier version, it would not maintain the line and page breaks or the overall look of the original document.

A third way to solve the font problem would be to bundle the fonts with the document before sending it over the network. This approach would ensure that the receivers see the document in its original form. However, although the document itself may only be 3 to 4 KB in size, the fonts that go with it could push that number to over 120 KB, slowing the network to a virtual crawl.

Another approach, using Multiple Master fonts, provides a more efficient method of document interchange. Using variables of character weight and width, a Multiple Master font can closely match the fonts used in the original document (see figure C). Thus, between the original and the received documents, line and page breaks are identical, and the overall look of the text is the same.

You can use one Multiple Master font successfully for font substitution because it matches all the document's original fonts on a character-by-character basis. In addition, this approach minimizes overhead because only the font metrics (typically less than 1 KB

per font) need to be transmitted with the document.

Based on Adobe's open Type 1 font format specification, Multiple Master typefaces are compatible with existing technology. Each Multiple Master typeface enables you to create a large selection of fonts using a design matrix based on one or more variables of weight, width, size, and style—weight and width are by far the most widely used variables. You are able to generate any instance within this matrix using any combination of the included variables.

Today, a typical font family includes several weights (e.g., light, regular, bold, and black) and perhaps one or more variations in width (condensed, normal, and/or expanded). You are limited to the choices available in the font family, or you can resort to software that artificially bolds, lightens, expands, or compresses an existing design. These processes distort letter shapes and proportions, which can adversely affect the legibility of the text and distract the reader.

Multiple Master typefaces let you select the weight, width, size, and style of typefaces that will best suit your needs as well as provide you with systems-level solutions in document portability.

Multiple Master Fonts

Because a Multiple Master font can produce a wide range of typeface variations, it can precisely match the copyfit of a document created in an entirely different typeface, even though designs of the characters in the Multiple Master font might have little in common with those of the font it's trying to match.

Figure A: *The original document uses a mix of serif and sans serif fonts.*

Multiple Master Fonts

Because a Multiple Master font can produce a wide range of typeface variations, it can precisely match the copyfit of a document created in an entirely different typeface, even though designs of the characters in the Multiple Master font might have little in common with those of the font it's trying to match.

Figure B: *Using the default printer font results in the loss of the original look of the document.*

Multiple Master Fonts

Because a Multiple Master font can produce a wide range of typeface variations, it can precisely match the copyfit of a document created in an entirely different typeface, even though designs of the characters in the Multiple Master font might have little in common with those of the font it's trying to match.

Figure C: *Multiple Master font technology retains the metrics of the original fonts to preserve the look and spacing of the original document.*

would shed little light on how to address the problem practically. Most attempts to define standards by committee are plagued by the need to reach agreement among many different interest groups and factions. Compromises are made, and the result is often a "paper standard" that is too abstract and complex to be practical or has wandered so far from the original objective that nobody wants to implement it.

This indictment of traditional standard-making processes in no way implies that the members of standards groups are not trying to do the right thing or are not sincere in their desire to offer a solution. Many of the efforts of the individuals are very good technically. It's the process itself that is flawed.

Establishing effective standards means building something that solves the problem in a practical way, serves the needs of the user community, is general enough to be extended into the future, and is not proprietary. The market will decide when a solution is real.

After the market has accepted a solution, formal standards groups should convene to clean up, endorse, and codify the standard. This is the market-based strategy that Microsoft used to establish the DOS standard and that Adobe used to establish the PostScript-language standard.

A Document-Interchange Road Map

Establishing a viable document-interchange strategy is a two-phase process. Both phases are necessary to avoid the catch-22 that bedevils new technology: Who will write applications to support a format that doesn't have widespread use? And who can use a format that doesn't have widespread application support?

The first phase requires enabling the majority of computer-generated documents to be transmitted, viewed, and printed across diverse platforms. This phase must be independent of the specific interests of any one vendor of operating environments or hardware architectures. Once accomplished, the user community will see the value of communicating documents electronically.

When electronic communication of documents becomes commonplace, the applications that make it easiest and that best exploit the interchangeable-document format will gain in popularity. Demand will drive normal market forces to proliferate the format. In other words, create a format that works and has practical value to the end user, and that value will drive the market to the common format.

The goal of the first phase should be to capture documents from existing applications in a way that is independent of de-

vice, operating-system, and hardware. Fortunately, modern windowing environments provide a common, device-independent interface between the applications and the operating-system imaging models. And these imaging models have interfaces to printer drivers: Graphics Device Interfaces in the Windows environment, QuickDraw interfaces in the Mac environment, and Graphics Programming Interfaces in the OS/2 environment.

One approach is to develop specialized printer drivers for each environment that will capture the output from applications and convert it to a single, uniform document-interchange format. With this format, you can write document viewers and printing utilities for each platform. A collection of such drivers, coupled with viewing and printing facilities, will enable the initial communication of documents between diverse platforms without changing existing application programs.

This is the course that Adobe has taken with its document-communication technology, code-named Carousel. Applications create Carousel documents by sending their output to a printer driver containing a Carousel module.

In environments that support device-independent printing, any application that prints can create a Carousel document. In the DOS environment, you can convert PostScript output files to Carousel documents with a utility program. Thus, only DOS applications that support PostScript can create Carousel documents. Of course, about 5000 applications on all platforms now support PostScript, so this isn't a very onerous restriction.

One of Carousel's fundamental concepts is that you should be able to work with electronic documents in the same way that you work with paper—and still be able to take advantage of their being computer files. Carousel documents are, therefore, partitioned into pages that you can read with a viewer application, just as you would read a book or a magazine.

However, unlike paper, the Carousel viewer lets you attach electronic notes, search for specific words or phrases, and create active links between an outline and a document and between different parts of a document. These links let you navigate around a document in many ways. As Marshall McLuhan might say, Carousel has taken its initial content from the paper medium, but it extends this content using the capabilities of the personal computer.

Because Carousel is page-oriented, it's important that the documents it handles retain the format of the original document. The most difficult aspect of this task lays in handling fonts. Carousel uses Adobe's

Multiple Master font technology to ensure that documents retain as much of the look of the original document as possible without needing to contain the actual fonts used in their creation (see the text box "Matching Fonts" on page 259).

Beyond Carousel

Carousel technology represents an initial step toward portable documents. In this step, some of the information relating to the objects in the application are lost in the communication to the print driver. For instance, the relationships between the numbers in a spreadsheet are lost when the spreadsheet is formatted for printing.

The loss of information doesn't prevent you from using a common document-interchange format to communicate the *appearance* of the document. Later, as application programs support document interchange more fully, object semantics can be inserted into the interchange format. Then you can realize the full communication potential of document interchange as you edit the same document across diverse platforms and applications.

The second phase to document interchange is to build powerful applications that use a common document-interchange format and to leverage the cross-platform sharing of object semantics that such a format would allow. These applications should demonstrate how document interchange and common editing structures can work and how the use of the extension techniques can add semantic information to the standard. If these applications give substantial value to the end user, applications developers will build new interfaces to the document-interchange drivers, and a new standard, both real and useful, will appear.

In looking to the future of computing, people must focus on the abstractions of information and how they use those abstractions to communicate ideas effectively. Computers shouldn't be the center of our attention—the information should.

Documents are abstractions of information that have been refined in many ways to communicate ideas. To date, the document is one form of information that remains difficult for personal computers to communicate. It's time to expand our horizons. If computers can do anything, they should be able to effectively transmit and receive that basic staple of our information diet: the document. ■

John E. Warnock is chairman and CEO of Adobe Systems (Mountain View, CA), which he cofounded in 1982 after being a senior scientist at Xerox Palo Alto Research Center. You can reach him on BIX c/o "editors."

**WHERE
ON EARTH
CAN YOU CALL US
FOR AS LOW
AS \$20
AN HOUR?**

Now you can connect with BIX, the on-line information service, at a fixed hourly rate from many cities around the world. Compared to packet switching networks, this saves you up to 75% depending on your location. There's

no application process. No character or packet fees. No extra charge for 2400 baud. And you're billed directly by BIX for your phone usage. Just call the access number nearest you, log on, and the world of BIX is at your fingertips.

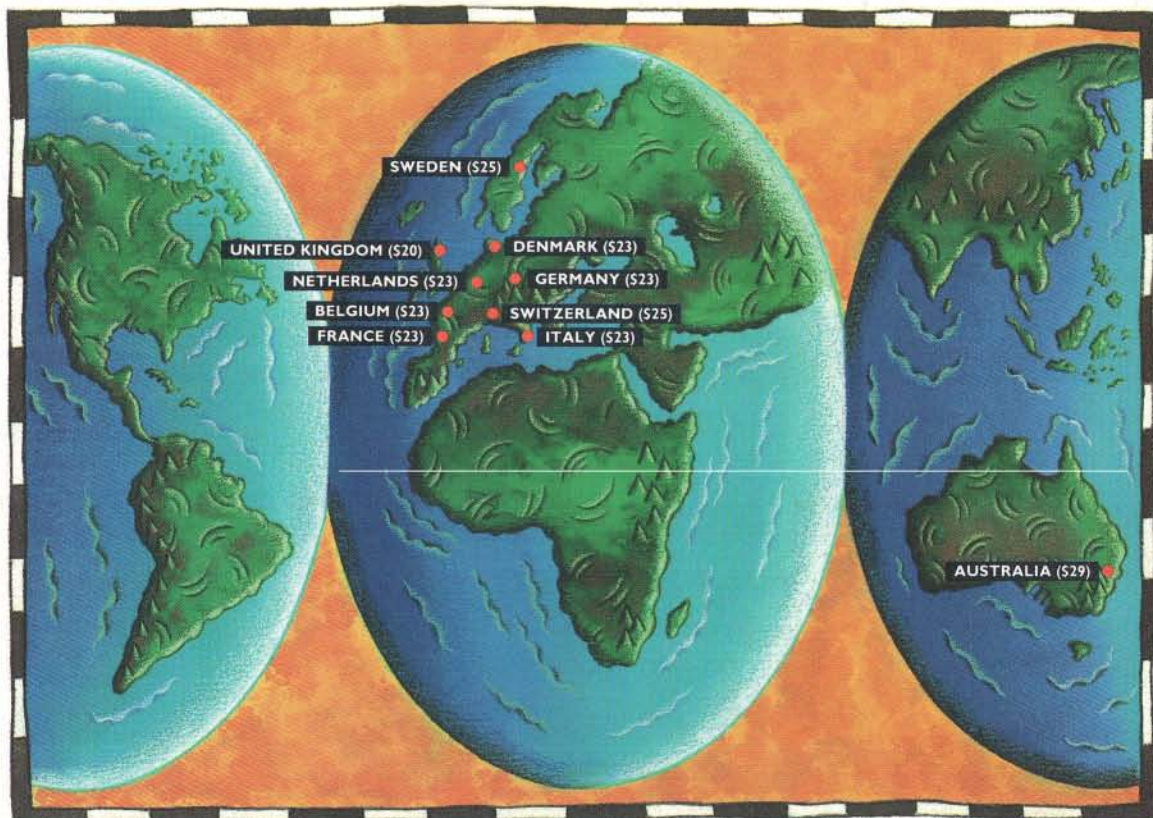

BT Tymnet Access Information: (All amounts are U.S. dollars)

AUSTRALIA (\$29/hr): MELBOURNE (3) 4162146; SYDNEY (2) 290-3400 **BELGIUM** (\$23/hr): BRUSSELS (2) 725-5060 **DENMARK** (\$23/hr): COPENHAGEN 31-18-63-33 **FRANCE** (\$23/hr): PARIS (1) 47719133, (1) 46027003, (1) 46025750, (1) 46025500; LYON (7) 8478144 **ITALY** (\$23/hr): MILANO (2) 66-98-30-04 **NETHERLANDS** (\$23/hr): ALKMAAR (72) 155190; AMSTERDAM (20) 6610094; EINDHOVEN (4902) 45530; THE HAGUE (70) 3475032, (70) 3814641; ROTTERDAM (10) 4532002 **SWEDEN** (\$25/hr): STOCKHOLM (8) 294782 **SWITZERLAND** (\$25/hr): GENEVA (22) 782-9329; ZURICH (1) 730-9673 **UNITED KINGDOM** (\$20/hr): BIRMINGHAM (21) 6326636; BRISTOL (272) 255392; CAMBRIDGE (223) 845860; EDINBURGH (SCOTLAND) (31) 3132172; LEEDS (532) 341838; LONDON Baynard House (71) 4898571, Ealing (81) 5667260 **GERMANY** (\$23/hr): COLOGNE (221) 210196; FRANKFURT (69) 666-8131, (69) 666-4021; MUNICH (89) 350-7682

To learn more about BIX see our other ad elsewhere in this magazine.

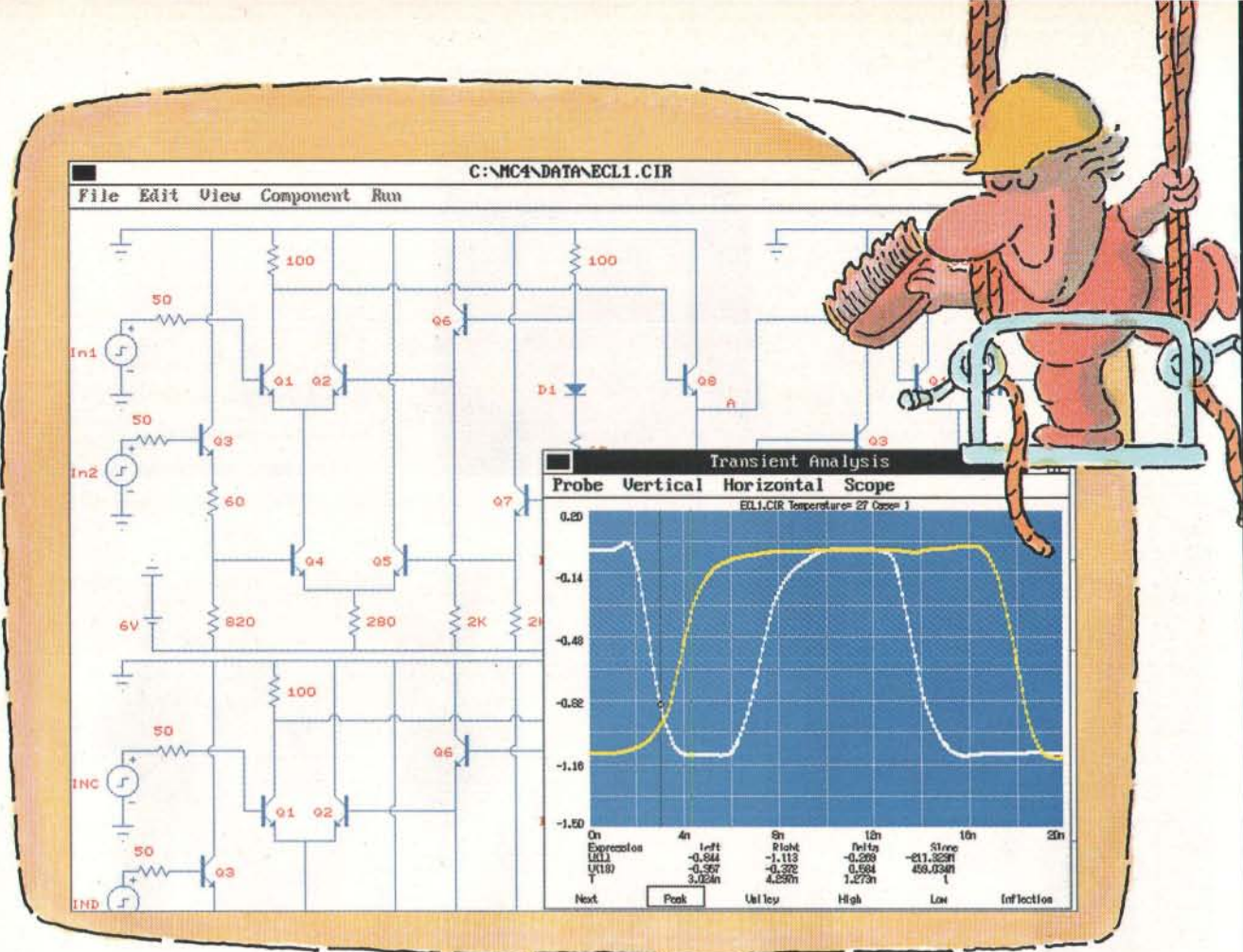

INTRODUCING MICRO-CAP IV.™ MORE SPICE. MORE SPEED. MORE CIRCUIT.

PC-based circuit analysis just became faster. More powerful. And a lot easier. Because MICRO-CAP IV is here. And it continues a 12-year tradition of setting CAE price/performance standards.

Put our 386/486 MICRO-CAP IV to work, and you'll quickly streamline circuit creation, simulation and edit-simulate cycles — on circuits as large as 10,000 nodes. In fact, even our 286 version delivers a quantum leap upward in speed. Because, for one thing, MICRO-CAP IV ends SPICE-file-related slowdowns; it reads, writes and analyzes SPICE text files and MC4 schematic files. It also features fully integrated schematic and text editors. Plus an interactive graphical interface — windows, pull-down menus, mouse support, on-line HELP and documentation — that boosts speed even higher.

Now sample MICRO-CAP IV power. It comes, for example,

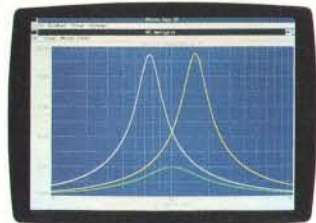

AC Analysis

from SPICE 2G.6 models plus extensions. Comprehensive analog behavioral modeling capabilities. A massive model library. Instant feedback plotting from real-time waveform displays. Direct schematic waveform probing. Support for both Super and Extended VGA.

And the best is still less. At \$2495, MICRO-CAP outperforms comparable PC-based analog simulators — even those \$5000+ packages — with power to spare. Further, it's available for Macintosh as well as for IBM PCs. Write or call for a brochure and demo disk. And experience firsthand added SPICE and higher speed — on larger circuits.



1021 S. Wolfe Road
 Sunnyvale, CA 94086
 (408) 738-4387 FAX (408) 738-4702

ELECTRONIC BOOKS

Hypertext publishing lets you structure, distribute, retrieve, and annotate the information you need

LOUIS R. REYNOLDS AND STEVEN J. DEROSE

Soon, you won't have to worry about running out of space on your bookshelves, and you will not have to carry those heavy boxes of books from one house to another when you move. In the near future, you will see a great many of your favorite books available on disk. Electronic books are fast coming into being.

Over 25 years ago, Andries van Dam, pioneer in user-interface languages, coined the term *electronic books*. It refers to interactive live documents that you can create and read on a computer. Electronic books preserve the best features of paper documents while adding rich, nonlinear information structures (often called hypermedia) and interactive user-controlled illustrations.

Recently, a number of vendors introduced hand-held computer devices that allow you to read large documents on-screen and output them as hard copy. In the meantime, software is appearing that uses modern high-end display capabilities so that you can easily and comfortably read books in electronic form.

In theory, electronic books have been possible for decades. The concept goes back to at least 1945. Pioneering systems began appearing in the 1960s, but at that time, only mainframes had the required speed, storage capacity, and display quality. In the late 1970s and the early 1980s, second-generation systems appeared on more affordable hardware, but you could create only simplified documents with them.

Recent technological advances have made it possible for the new medium to exceed the capabilities of paper, and now new systems will offer dynamic electronic





IEEE-488

You can control any IEEE-488 (HP-IB, GP-IB, 488.2) device with our cards, cables and software for the PC/AT/386, EISA, Micro Channel and Macintosh II. You get fast hardware and software support for all the popular languages, plus a software library of time saving utilities. Instrument control has never been easier.

FREE Informative Catalog **800-234-4CEC**
Applications help **617-273-1818**

cec Capital Equipment Corp.
Burlington, MA. 01803

Micro Channel is a trademark of IBM

Early Electronic-Text Pioneers

In 1945, President Roosevelt's science adviser Vannevar Bush conceived of what later became the Memex, a machine that stored huge amounts of text and helped users index and organize the information. He also suggested providing an easy way to make and reuse connections between texts. For this reason, many consider the Memex to be an early forerunner of hypertext. In the late 1960s, actual electronic text systems began to appear.

In the early 1960s, Doug Engelbart built Augment for the Stanford Research Institute. Augment is an on-line document environment used for E-mail, collaborative design and writing, and other related tasks. Engelbart's staff did much of its work without paper, creating large and small documents with links, outline-style hierarchical structures, keywords for retrieval, embedded graphics, and a variety of other features. They could even coedit documents in real time across hundreds of miles. The documents they generated still exist and fill hundreds of magnetic tapes.

Around the same time, Ted Nelson (now the head of the Xanadu project at Autodesk) began to write about his vision of a future where all literature would be instantly available to everyone to read, explore, link, and annotate. Nelson created the terms *hypertext* and *hypermedia*, and he contributed to early research on hypertext at Brown University. His team is designing and developing Xanadu, a software environment to make his vision possible.

At Brown, van Dam and his students built HES (Hypertext Editing System) and later developed FRESS (File Retrieval and Editing System), which was a full-featured hypermedia system for unlimited-size documents that built on the insights gained from HES and Augment. FRESS supported WYSIWYG, multiwindow editing, and the then-revolutionary idea of using seamless text rather than fixed 80-byte lines.

FRESS introduced the undo operation and some hypertext capabilities that are considered advanced even today. Text and links had keywords and attributes for retrieval, on-the-fly information filtering, and formatting. FRESS provided the user with multiple document views, such as an outliner, bookmark index, hypertext link overview, and others (all updated when any of them changed). In a number of courses, students read textbooks, wrote papers, and interacted in the FRESS "web." In addition, NASA even used FRESS for Apollo documentation. The system still works today.

books that fully utilize your computer's strengths. Electronic books will be made possible by the combination of powerful processors; high-density storage; and interchangeable, processible representations of text, graphics, and multimedia documents.

Until now, desktop publishing had principally focused on paper output. The electronic medium, however, has numerous unique strengths. Some of the newest electronic-book systems make use of

those strengths rather than merely imitate paper.

Importance of Electronic Delivery

People need a strong motivation to convert from a familiar, established method to a new way of doing things. Electronic books provide a significant economic advantage. Companies see electronic books as a way to save on production costs and to improve accuracy and timeliness.

Many firms use large, complicated manuals, which can cost as much as \$1000 per copy to produce. On the other hand, a CD-ROM can hold several of these manuals, be shipped in an envelope, and cost under \$5 to produce. And the environmental advantages of using less paper are also significant.

Updating paper documents is expensive, time-consuming, and error-prone. Networks can serve many readers with one copy. With the increasing use of networks and CD-ROMs, publishers can provide updates efficiently and as often as needed. Helpful software can even alert readers to important changes.

Maintenance and service technicians can carry a full set of electronic manuals to customer sites. With this capability, technicians make fewer return trips to solve customers' problems. This benefit of electronic publication leads to lower support costs and more satisfied customers.

BYTE ACTION SUMMARY

On a rainy afternoon, you may want to turn on your computer and read the newest Stephen King best-seller. Before long, using SGML technology, good software, and some future interchange standards, your computer will provide you with a library of unlimited size and variety.

Initial Commercial Attempts

None of the first-generation electronic-book systems gained wide use because they required a great deal of computer power. As time went on, however, computers became more powerful, and another generation of electronic-text systems arose. Xerox's NoteCards introduced the idea of modeling documents as cards and was one of the earliest second-generation systems. It was the forerunner of a variety of tools designed to organize, link, and explore networks of information "chunks." Chunks are very useful, although dividing actual books into meaningful chunks is difficult.

NoteCards shared with first-generation hypertext systems a commitment to large-scale applications and support for hypertextual navigation, but it differed with them greatly in its model for documents. Xerox's application had a significant influence on later systems. Apple's 1987 introduction of HyperCard brought some of NoteCards' technology within the reach of many people. Although it's oriented toward small chunks of information, HyperCard has been used for some interesting large electronic-text projects.

Brown University's Institute for Research in Information and Scholarship developed Intermedia. It is a Macintosh-based hypermedia environment that provides tools for creating, linking, and navigating through collections of documents, including text, drawings, animations, sound and video, timelines, and other media. Later versions of this environment added full-text searching and a dictionary database. Brown and other universities have used Intermedia extensively.

Today there are a number of companies that produce hypertext applications (some of which publishers can apply to electronic-book projects). These firms use various technological approaches for their products, including Guide from Office Workstations (Edinburgh, U.K.), DynaText from Electronic Book Technologies (Providence, RI), and Folio Views from Folio (Provo, UT).

Design Issues

Early systems clarified the major issues involved in building useful electronic texts and explored the key differences between paper and electronic media. You can characterize electronic-text systems by how they handle fundamental issues such as the distinction between an author and a reader and the various types of document models.

Some texts are published as finished documents, after which nobody changes the text. In this case, additions (e.g., mar-

PS/2[®] MEMORY

Introducing OS/RAM32plus™ for the Micro Channel™

- ✓ Provides from 2 to 128 Mbytes of fast memory.
- ✓ Works in 16 or 32 bit mode to meet your needs.
- ✓ Provides extended and expanded memory.
- ✓ Fast software and hardware for LIM 4.0 included.
- ✓ Automatic configuration for DOS, OS/2 and UNIX.
- ✓ Easy to install. Risk free guarantee. Two year warranty.
- ✓ Add a disk cache and RAM disk using OS/RAM32plus to get maximum performance from your computer.
- ✓ Free up low memory by moving your drivers and TSR's to OS/RAM32plus. We guarantee compatibility!

Call today 617-273-1818 or 1-800-234-4CEC

cec Capital Equipment Corp.
Burlington, MA. 01803

PS/2 and Micro Channel are trademarks of IBM

ginal notes and highlighting) are easy to distinguish from the author's words. Other texts are never published in a fixed form but are constantly being changed by authors and readers.

Traditional databases depend on repeating identical structures, and card- or page-based systems treat text the same way. But full-text systems must provide multilevel hierarchies, with no limits on size, type, or heterogeneity of nodes. The search function in structured documents is different from that in relational databases because the structure of the elements cannot be established in advance.

Another important issue in electronic documents is how to prevent a user from getting lost. With paper books, you can dog-ear pages or use bookmarks, but electronic books are another matter. Think of your computer screen as a library filled with books that have no covers—the information is in there somewhere, but where? The electronic medium needs to provide ways to match the ease with which you can navigate through paper documents.

Early printers imitated the style of handwritten manuscripts, but they found that what works best in one medium is not always the best choice for another. The same kind of transition is happening in the evolution from paper books to on-line texts. Many computers still have low-resolution

displays, and they provide a smaller physical space than a desktop full of open books. On the other hand, on-line text can change to fit your needs and interests—paper cannot.

Differences between types of media mean that systems designed to make the best use of one form may not make the best use of another. Thus, authors and publishers are rapidly adopting descriptive markup systems, which classify and mark parts of documents according to what they are rather than how they appear. For example, a chapter title would be labeled "chapter title" instead of "18 pt. bold centered." Rules then specify the desired appearance of each class of element, and the rules can be designed separately for each medium.

The Holdup

Until now, several factors have held back the development of electronic books. The production process has been very expensive because of the demands for large amounts of processor power and storage. Only recently have truly portable and affordable machines appeared with storage sufficient for several books. Companies with large and complex manuals were the first to adopt the technology because their savings exceed start-up costs.

Another problem had been that very few people had expertise in electronic-book

Industrial-Strength Electronic Documentation

Hypertext applications that rely on technologies such as DynaText (a software system for on-line delivery of electronic books) are rapidly entering the mainstream of many large industries' working environments. Worldwide adoption of SGML (Standard Generalized Markup Language) is hastening the development of the electronic-information-publishing infrastructure in industries that have formally adopted the ISO standard. The following are examples of application areas that are under development.

Defense Contractors

The Department of Defense adopted SGML as part of its CALS (Computer-aided Acquisition and Logistic Support) initiative. The ultimate goal of CALS is to eliminate paper from all phases of a document system's acquisition, development, and field support. In addition to SGML, the Department of Defense has adopted a number of related standards, including an interface standard for what is known as IETM (Interactive Electronic Technical Manual).

Several projects are under way to de-

velop IETMs that are tightly integrated with expert systems and logistics-support databases. The goal is to provide state-of-the-art maintenance support systems that manufacturers can deliver on rugged portable computers and across secure networks. Technology such as DynaText can display chosen portions of a document (e.g., an inspection task) after an expert diagnostic system determines the source of a problem, a process that facilitates efficient field maintenance of a complex system.

Aircraft and Telecomm Manufacturers

Standardization efforts in the aircraft industry have led to the adoption of SGML as the preferred electronic delivery form for aircraft documentation. Airlines and aircraft manufacturers are waiting for the day when they can obtain all their manuals electronically. The results of this process would streamline the updating of the manuals and improve safety.

This type of technology is enabling development of electronic delivery systems for everything from in-flight operations manuals that pilots view in the cockpit to electronic maintenance

manuals that service people could use on hand-held work slates in a maintenance hangar.

The TCIF (Telecommunications Industry Forum) has adopted SGML for use by equipment manufacturers and service suppliers. This implementation will facilitate the on-line delivery of the voluminous technical documentation associated with complex telecommunications equipment. The acceptance and widespread use of SGML effectively enables carriers to enter the electronic-information-delivery business.

Miscellaneous Applications

Some industries have not yet formally adopted SGML. Nevertheless, some firms are using technologies such as those found in DynaText for academic publishing, on-line help systems, information gathering and analysis, and field-service training.

To meet the diverse requirements of all these application areas, a successful product must provide a flexible and open architecture. The product must be able to handle arbitrary SGML (Document Type Definitions) and industrial-strength and -size applications.

production. Implementing a project from data entry, encoding, and indexing to designing an effective user interface requires many skills. Some expertise from paper-book production translates directly, but much does not. And, as in any new field, it takes time to develop stylistic conventions and effective presentation methods.

In addition, the lack of agreement on document representations had retarded progress. Each system has its own format, and beyond moving raw text, only a few have interchangeable format capabilities. It's often difficult to move documents between publishing systems without custom conversion filters, and most of these filters lose important information along the way (e.g., style-sheet information and equations).

Why Now?

Companies are publishing electronic books now because they have begun to solve many of the technology's major problems. Books used in offices offer greater benefits because they can be distributed on networked workstations that have superb display quality and virtually unlimited storage. Producers of large and expensive books will find that electronic delivery is cost- and time-effective because the new personal computers have tremendous power—some small notebooks weigh less than paper books, and they can store more information.

Start-up costs have dropped significantly for publishers and for those buying the reading hardware. In many cases, mastering a CD-ROM costs less than type-

setting a book. Nearly all publishers prepare new documents on-line. Scanning and automatic-tagging technology (e.g., Avalanche Technology's Fasttag) are accurate enough for many retrospective conversion jobs.

Finally, and very importantly, there has been rapid movement toward standards for document representation. The centerpiece of this movement is SGML (Standard Generalized Markup Language), which became a formal international standard in 1986 (ISO 8879).

Information Publishing Standards

Authors and publishers have long struggled with the problem of interchanging documents between processing systems. An author who prepares a document using

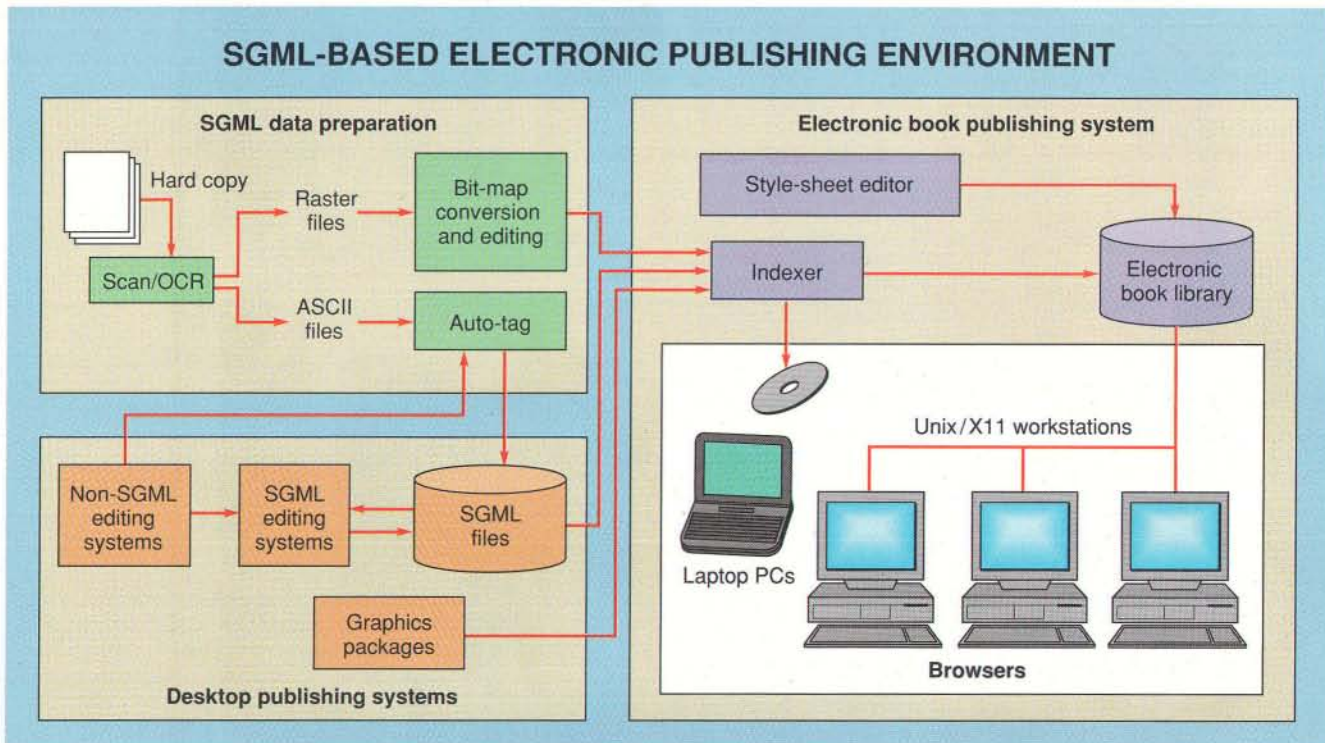

Figure 1: The structure of an integrated, SGML-based paper and electronic publishing system. Once in SGML form, data is fed directly to DynaText for electronic delivery on Unix networks and portable PCs.

one program often cannot send the document to a publisher for editing on another system or exchange the document with a coauthor. Word processing tools seldom allow document storage in ways that permit their reuse for other applications (e.g., cataloging, information retrieval, and electronic delivery).

The more publishing a company does, the more it must deal with these problems. As a result, many major industries have adopted SGML since the ISO's formal approval of the standard, and the trend is continuing. This move has strongly motivated software vendors to support SGML (although they do so in greatly varying degrees).

In 1987, the Association of American Publishers started the trend toward the use of SGML by designing an SGML tag set for books and journals, which has become an ANSI standard. In 1988, the Department of Defense declared that, for eventual use in interactive electronic technical manuals, contractors must deliver all documentation for future weapons systems in electronic form, with the textual portions in SGML.

In 1989, the Aircraft Industry and Air Transport Associations followed the Department of Defense's lead and developed SGML tag sets for aircraft maintenance and operations manuals. This process

helped to unify and streamline operations in the industry because many vendors sell both commercial and military aircraft. In 1990, the Telecommunications Industry Forum developed SGML applications for systems documentation, information interchange between vendors, and several other applications. In 1991, the computer industry geared up, too, when various Unix system vendors got together to develop SGML encodings for on-line documentation.

At the same time, academic researchers also adopted SGML. The TEI (Text Encoding Initiative) is a widely supported international effort to standardize the encoding of literary and other texts. Various groups are preparing collections of texts (totaling gigabytes of data) tagged according to the TEI guidelines.

SGML Technology

To build electronic books in SGML, you need several pieces of technology, all of which have become available in the past few years (see figure 1). The first component of an SGML-based electronic-book environment is an authoring system, with which writers create and edit documents. SGML-based authoring systems either typeset documents directly or export them to a formatting engine.

It's essential that an authoring system

support SGML. Consider a document in which part numbers, emphatic words, and book titles have distinctive tags (perhaps to permit sorting or searching), although each element also appears in italics under current printing rules. If an authoring system only records formatting, as many do, there is no way for the system to recover or use the distinction between elements of the document—all three things have become just italics.

Often a publisher or an author will have data that is not in SGML and will need conversion tools (once it's in SGML, it is usually easy to convert it into other formats—another reason SGML is useful). Manual-tagging and global-change commands are only sufficient for small projects. Making hypertext links (e.g., converting documents) shouldn't have to be performed by hand.

The final component of an SGML publishing environment is the electronic-book delivery engine. When the data is ready, the interface is the tool readers use to view it. The interface is crucial to the success of an on-line book project. It must have a familiar paper-like feel.

The interface must provide as many advantages of paper as possible but not have its limitations in areas where displays are superior. It must handle documents in the tens to hundreds of megabytes and still

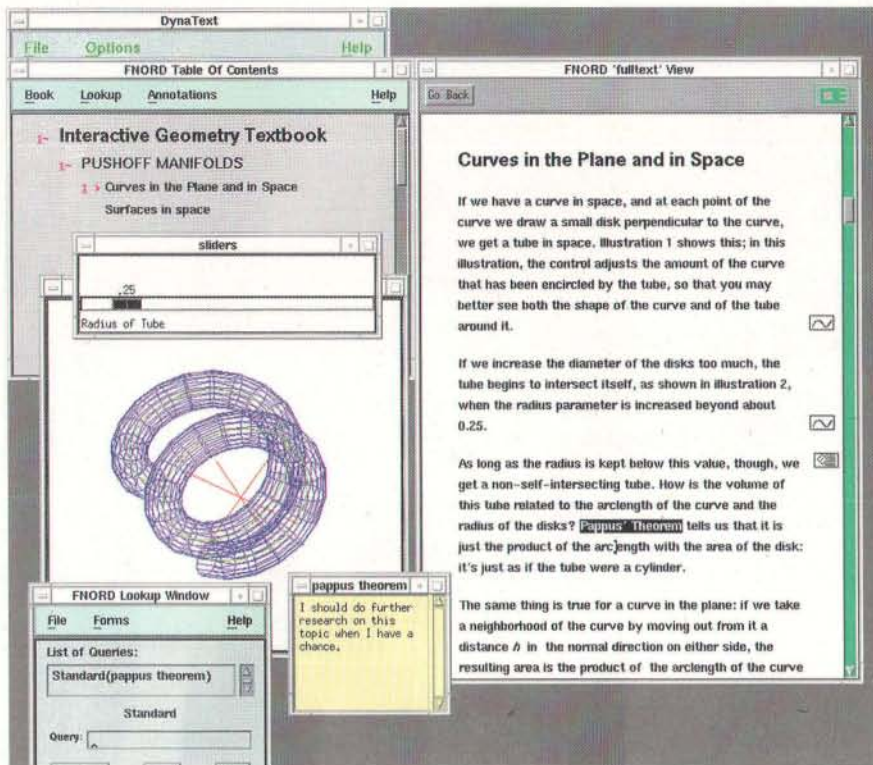

Figure 2: Running on a Unix workstation with Motif, the display includes a hierarchical table of contents window and a full-text view with several link icons. The reader has searched for the phrase "Pappus' Theorem" and clicked in the table of contents to scroll to the section on curves. The reader has followed a link to an external, interactive three-dimensional modeling program that illustrates the theorem. Finally, the reader has created an electronic note as a reminder to do additional research. The Brown University Graphics Group prepared this interactive textbook. (Courtesy of Electronic Book Technologies)

respond quickly to a user. In addition, SGML's fundamental idea of descriptive markup (as opposed to markup for particular processing or layouts) provides a clear path to the multimedia document environments of the future.

A New Breed

DynaText is a software system for on-line delivery of electronic books. It allows you to display information in various forms and uses CPU cycles to do more than put bits up on a screen.

An effective electronic-book delivery program relies on the strength of SGML's descriptive markup approach: separation of the format from the content. It preserves the SGML structure throughout a project rather than translating this structure into specific formatting. By using a product such as DynaText, publishers can take full advantage of SGML's expressiveness—including arbitrary DTDs (document type definitions)—for both paper and electronic delivery.

With DynaText, publishers are able to

display any number of document views simultaneously, each formatted according to its own particular style sheet rather than one predetermined, static view. Figure 2 illustrates a number of these capabilities.

DynaText also uses the SGML markup to represent hypertext links. Thus, by using style sheets, publishers can define the behavior of SGML elements. For instance, footnotes and tables can be either displayed in-line or tucked away behind hypertext links for retrieval by a simple click of a mouse. Publishers can use a set of built-in link-script properties, or they can define their own link behavior (e.g., launching an external program such as a multimedia viewer).

This application provides a systems-integrator toolkit that lets programmers create customized user interfaces and use the toolkit's capabilities for SGML navigation, retrieval, and display (see the text box "Industrial-Strength Electronic Documentation" on page 266).

DynaText runs in both Unix/X Win-

dow System and PC/Windows environments, and a Mac version is planned for release later this year. Documents published with this program are fully data compatible across all platforms, so publishers are not locked in to only one platform. They can index documents on high-end Unix machines, for example, and then deliver them on CD-ROM-equipped PC/Windows portables.

The Future

Recent advances in display and storage capabilities, hypertext research, and standards for information representation make it practical to deliver books and other large documents in electronic form. As a result of the early research performed in the 1960s and the practical systems developed in the 1970s and 1980s, electronic books will soon become a common publication medium.

In the world of electronic books, workable interchange standards are crucial to making information accessible to everyone. At the same time, open and extensible systems to take advantage of the constantly growing capabilities of this new medium must be developed. To achieve this state, publishers and software developers must strive for better agreement on representations for graphics, video, and style specifications.

A number of standards are under development. The crucial ISO HyTime standard encodes hypertextual, temporal, and spatial information (this ISO standard should be formally approved by the time you read this article). DSSSL (Document Style, Semantics, and Specification Language) specifies formatting rules. Multi-byte character codes represent most languages in a single set. Additionally, other standards are being developed to represent fonts, colors, and so forth.

As systems are designed for the electronic medium, people must take advantage of the strengths and overcome the weaknesses of the paper and the electronic forms. To reach this goal, people must have a good understanding of both media and commit themselves to finding new and better ways of presenting information on-line. ■

Louis R. Reynolds is president and CEO of Electronic Book Technologies. Steven J. DeRose is senior systems architect at EBT and chair of the Text Encoding Initiative's Hypermedia Working Group. He has worked with hypertext systems since 1979. You can reach them on BIX c/o "editors" or on Internet at lrr%ebt-inc@uunet.uu.net and sjd%ebt-inc@uunet.uu.net, respectively.

PC DIAGNOSTICS MADE EASY

SPEED TEST YOUR PC

You've seen the **Landmark Speed Rating** advertised by many major PC manufacturers, now you can have your own copy of the **Landmark System Speed Test™**. Accurately measure CPU, math, and video speeds to make an informed purchasing decision, determine the best PC for the job or maybe just win some bets in the office on whose PC is really faster! Includes the Landmark AT CMOS RAM Setup program to update your system configuration on-the-fly. **CALL for current pricing!**

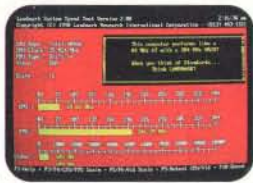

PC WON'T BOOT? THEN JUST KICKSTART IT!

Don't replace your motherboard, use **KickStart 2™**. When serious hardware problems occur, nothing gets you up and running as fast. **KickStart 2** measures power within 2.5% on all four voltages, shows Power-On Self-Test (POST) failure codes, and features on-board ROM-based diagnostics allowing you to determine and remedy the problem quickly, easily, and inexpensively!

Built-in serial and parallel I/O allows for testing via modem, or simply logging results to a remote terminal, printer or laptop. You can configure your own test routines and store them in KickStart 2's battery backed-up CMOS RAM saving valuable setup time. Includes serial and parallel loopback plugs and Landmark JumpStart™ AT ROM BIOS for testing PCs that don't issue POST codes. **KickStart 2 tests your system regardless of O/S (even UNIX).**

On-board switches, LEDs, and digital displays allow complete control over testing in systems lacking video or disk (ideal for motherboard or system burn-in).

KickStart 2 is the ultimate SECURITY CARD too! With both supervisor and user levels of password protection, you can prevent unauthorized use of your PC and accidental running of destructive tests. **CALL for current pricing!**

"KickStart 2 system diagnostics board helps users check out virtually every aspect of a PC's hardware system... the board is a worthy investment for computer maintenance." David Claiborne, PC Week



KickStart 2 is ideal for permanent installation. It eliminates the need for an I/O card, provides remote and on-site diagnostic capabilities for quick repair time and offers a solid hardware based solution to unauthorized access with impenetrable password protection.

SLASH DOWNTIME AND OPERATING PROBLEMS



With **PC Probe™** you'll save time and money when your PC starts acting up. In one easy-to-use package you get **Diagnostics, Virus Protection (for over 700+ known viruses), Benchmarks, Performance Enhancement Utilities, and System Information.** Combined, this arsenal of tools will keep your system up and running at peak performance and remove the mystery about what's inside.

PC Probe diagnostic testing quickly isolates the source of hardware problems, even locating bad RAM chips. It tests system board, RAM, video, keyboard, com ports, floppy drive, hard drive, Ethernet card and more. Run **PC Probe** tests in batch mode or single pass, remote or on-site.

PC Probe allows you to increase your hard drive data transfer rate by determining optimum interleave and changing it, prevent catastrophic data loss by performing data revitalization, reformat the hard drive, run external programs, display and edit CMOS RAM on-the-fly, prevent accidental hard drive data destruction with passwords, diagnose problems with device drivers installed.

The 200 page on-line manual has built-in table of contents, topic/text search, and troubleshooting tips. **PC Probe** comes with dual size floppies and 9 & 25 pin serial/parallel port loopback plugs. For **PC XT, AT, 386, 486** and compatibles using **DOS 2.0** or higher. **CALL for current pricing!**

- Toll-Free Lifetime Tech Support
- 90 Day Money-Back Guarantee
- Federal Express Shipping

CALL (800) 683-6696

Fax (813) 443-6603 • Voice (813) 443-1331
Dealer Inquiries Welcome



LANDMARK
RESEARCH INTERNATIONAL CORPORATION
First in PC Testing... Since 1981

703 Grand Central Street • Clearwater, Florida 34616

Copyright ©1991, PC Probe, AlignIt, KickStart, JumpStart, ROM POST, and Service Diagnostics are trademarks of Landmark Research International Corp. All Rights Reserved. Other names are trademarks of their associated owners.

THE 5 MINUTE SOLUTION TO FLOPPY DRIVE FAILURE

With **AlignIt™** you can clean, diagnose, and align your floppy drives in minutes without a scope. Patented technology requires only a screwdriver to perform ANSI-accurate alignments (.3 mil).

AlignIt is ideal for corporate users with 2 or more PCs because it includes a "GOLD STANDARD" feature so you can align all your PCs to the same in-house standard, guaranteeing that all your floppies are perfectly interchangeable between PCs.

80% of all floppy drive failures can be fixed with **AlignIt**. So don't replace your drive, save time and money instead.

Includes dual size floppies, (both high and low density) and no-mess pre-lubricated cleaning diskettes (both sizes) good for 180 uses. Replacements and single drive size versions available. For all PCs and compatibles. **CALL for current pricing!**

PROFESSIONAL LEVEL PC TROUBLESHOOTING

Landmark Service Diagnostics™ is ideal for professionals requiring the most exhaustive diagnostic test capabilities. Each module is CPU specific, including **PC, XT, AT, 386/486, and PS/2**. Since 1981 major manufacturers like Wang, Xerox, Prime, Sony, DEC, NEC, and NCR have relied on **Service Diagnostics** to tackle their toughest operating problems.

Intended for professional service and repair technicians, **Service Diagnostics** is also easy to use for the novice. Clear, concise on-line help and intuitive menus make finding system problems a breeze. Tests all CPUs, math chips, all memory, floppy, fixed and non-standard disk drives, standard/non-standard printers, system board, video, com ports and all keyboards. Utilities include low-level reformat, log bad sectors, edit bad sector table; the partition editor allows you to set up multiple partitions; back-up program transfers hard disk image on unformatted floppies and allows for restore after reformat.

Ideal for UNIX and other operating systems, the self-booting version doesn't require DOS. The manual offers troubleshooting tips to the component level. Also available in a complete kit including: all CPU specific software, dual size floppy alignment software (see **AlignIt**), and **PC/XT & AT ROM POSTs**. **PC Magazine Editor's Choice 8/90.**

HOW TO DEBUG A DEAD PC

Need an inexpensive solution for dead or problematic PCs and motherboards? Try **KickStart 1™** or **JumpStart ROM POST™**, two quick and easy to use debugging tools.

KickStart 1 test card shows power status on all four voltages and binary PORT 80 Power-On Self-Test codes. The manual translates error codes for easy failed circuit isolation. **CALL for current pricing!**

JumpStart ROM POST is a plug-in chip designed to replace your motherboard BIOS for testing purposes. Tests include CPU register and logic, 8087 math coprocessor, 8253 timer, 8237 DMA controller, 8259 interrupt controller, parity error and memory refresh logic, erroneous maskable/non-maskable interrupt detection, display adapter (MDA, CGA, EGA), keyboard, keyboard controller, floppy controller, drive A: read Base memory at normal & slow refresh rates, and POST checksum. Display of motherboard switch configuration. **CALL for current pricing!**



"Overall, Service Diagnostics: The Kit was the best performer. (You can) locate and identify most of the computer problems you'll ever encounter. If you're running a service department, Service Diagnostics is not an option, it's a necessity." Bill O'Brien, PC Magazine

- Service Diagnostics XT/AT Kit...SAVE \$\$ CALL NOW •
- Service Diagnostics PS/2 Kit...SAVE \$\$ CALL NOW •
- XT ROM POST...SAVE \$\$ CALL NOW •
- AT ROM POST...SAVE \$\$ CALL NOW •

— Individual pricing available on all kit components, please inquire —

HOW DO YOU GET A JOB WITHOUT EXPERIENCE? AND HOW DO YOU GET EXPERIENCE WITHOUT A JOB?

Most young people have one answer to this problem. They avoid it until they're out of college. But they could be getting solid work experience while they're still in college. With your company's help. And ours.

We're Co-op Education. A nationwide program that helps college students get real jobs for real pay, while they're getting an education. But we can't do it without you.

Those real jobs have to come from real companies. Like yours.

For more information on how you can participate in this valuable program, write Co-op Education, Box 775E, Boston, MA 02115.

Not only will you be giving students a chance to earn money and pick up the most valuable kind of knowledge, you'll be giving yourselves a chance to pick up the most valuable kind of employee.

Co-op Education.

You earn a future when you earn a degree.



SEARCH AND RETRIEVAL

How to evaluate large text-retrieval systems

EARLENE BUSCH

Managing text is much like managing children. When children are small, the parent has almost total physical control over them and can get by with simple management techniques—feed them regularly, change their diapers, and put them down for naps. As they grow, however, children are influenced by friends, reject family rules, and take on characteristics of their own—characteristics often not anticipated by the parent. Managing them becomes more complex and qualitatively different.

In a simple information management scenario, you have limited information to manage at your desk (hard copy and/or electronic)—a file of business contacts, a daily log, and several folders. You can easily retrieve the list of business contacts and the daily log by using a structure of formatted data (e.g., name of the contact, date on which the log entry was made, and company name). Accessing this type of information poses no organizational problems. You name the documents in the folders by assigning each one a keyword or phrase and a date or name. To find something, you simply review the keywords and phrases associated with the files and pull out those that appear to be relevant. This system uses one source, idiosyncratic information management schema, and a few documents. The management tasks are predictable and straightforward.

At the other end of the spectrum is the in-house or commercial document base. Whether delivered on-line or on CD-ROM, the task of retrieving information involves various information sources, a standardized information management schema, gigabytes of text, and many concurrent users. In contrast to the familiar system at

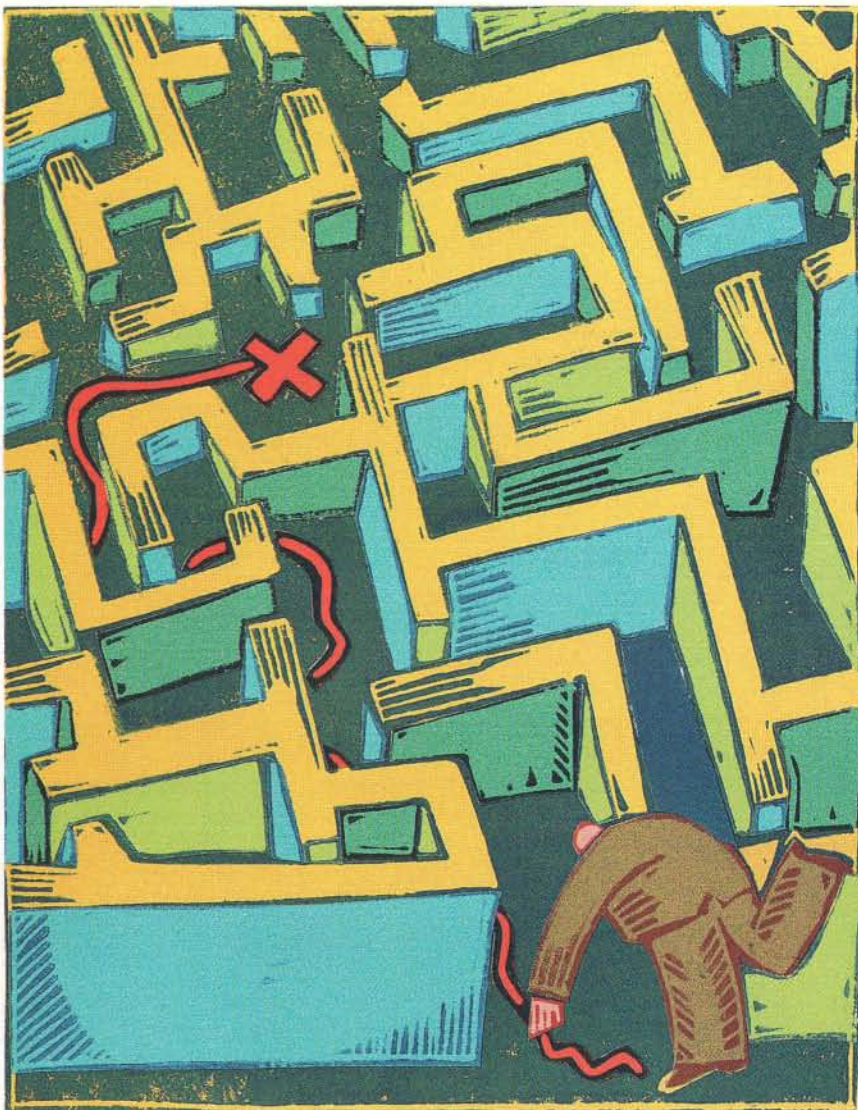

Document Clustering

THOMAS M. KOULOPOULOS

When faced with the problem of finding relevant information in a mountain of on-line documents, it's never clear just how much relevancy is out there. The result is that users of text-retrieval systems must become experts at using query languages and at understanding the nature of the documents they are searching for.

Too Much or Too Little

Most users of on-line search-and-retrieval systems have neither the time nor the interest to become experts at Boolean logic. In fact, the majority of these users rarely include more than two or three terms in their queries. The result is that either too much or not enough information is retrieved. This problem is referred to as *precision and recall*. The objective is to optimize the balance of both of these factors and get exactly the information that you need.

Many document management systems place the burden of striking this balance and formulating the right query squarely on the shoulders of the user. Document clustering seeks to reduce this burden by automating the process of inferring relevancy.

Clustering is designed to help users retrieve the relevant documents without

the aid of a thesaurus. The key objective of clustering is to respond to what the user's query did not say, could not say, but somehow made manifest.

Interpreting Intent

There are several methods of document clustering. In each one, interpreting the intent of a query is accomplished by inferring relevancy not just from a document's similarity to the user's query terms but also by the document's relevancy to general subject categories and other documents in the database. This is substantially different from traditional text-retrieval systems, which rank each document against the query alone.

Clustering is such an important development because of the peculiar nature of text queries, which involve the ambiguity, richness, and subtleties of language. Text queries constitute an inexact science. Consider, for example, the query FIND TEXT = AUTOMOBILE ACCIDENT, which is a request for all the documents that contain the phrase *automobile accident*. Will this find all the references to the accident, both direct and indirect? What if there is a memo in the textbase that refers to the automobile accident as an unfortunate incident? If the document was not retrieved, valuable information would

be overlooked. An on-line thesaurus sometimes provides assistance, but it can often be ineffectual in the face of elusive and ambiguous language. The problem with any thesaurus is that relevancy is not always based on word associations; in many cases, relevancy involves conceptual similarities.

In a clustered document management system, the example of a document containing the phrase *unfortunate incident* is likely to be retrieved even if the user only asked for "automobile accident" (see the figure).

Mimicking Human Thought

Another advantage of document clustering is that it also seeks to capture the associative nature of human thought. Our minds work by association as well as logic. Because a document database deals with the expressions of human thought (i.e., language), it needs to take this phenomenon into account.

Document clustering attempts to mimic the human thought process by grouping together documents with related ideas, concepts, and terminology, even where these relationships are subtle and implicit. It recognizes that the strength and value of a document database lies in the interrelationships among its documents and among the

BYTE ACTION SUMMARY

There is no need to be burdened with archaic query languages and the rigidity and limitations of strict Boolean logic in your large textbase searches. Modern systems include features of subject association, similar to the way our own memory works.

your own desk, you're faced with an information system over which you have no control and that offers myriad possibilities only if you make the right guesses.

The problem is how to find documents when you don't know who wrote them, when they were written, or the keyword or phrase associated with the documents. The value of a textbase system depends on how easily you can find information when you have little to go on. If there is no way to access the information without a keyword or phrase, the textbase system is of little value.

Clearly, the solutions designed for a personal information system are inadequate for a large textbase system. The focus of the information shifts from a personal information system to issues of a more fun-

damental sort. Providing a system as easy to use as the individual system is a worthwhile design goal, but the searching mechanisms must be appropriate for large information systems.

Current Technologies

Most software-oriented text management systems are based on a variation of database management technology: one designed to provide access to formatted data. When this technology is applied to text management, the resulting systems are generally referred to as *keyword systems*.

Keyword applications are characterized by an indexing technique that creates a word list resembling the index of a textbook. At the basic level, a keyword implementation provides a totally automated

subjects discussed in those documents.

The unique aspect of clustering that establishes these document associations requires the incorporation of knowledge engineering—the method by which user knowledge is transferred to the retrieval process. The difficulties of implementing this approach, although not insurmountable, should be considered.

In some clustering systems, knowledge engineering is done by ranking several thousand words specific to the document collection against each subject category. Even though the process takes only a few days to accomplish, it requires someone familiar with the collection's subject matter. Ultimately, this type of clustering model is only as good as the expert that defines the subject categories and the knowledge base used to rank the documents.

There is also an approach to clustering in which the knowledge engineering is based on the co-occurrence of words, a sort of statistical clustering. For example, if you turn to the sports section of any newspaper during baseball season, you are likely to find a number of articles that make no mention of the term *baseball* but use other words or phrases that are associated with the sport (e.g., home run and stolen base). The statistics of word occurrences and their location provide enough information to generate clusters.

Learning by Example

Finally, clustering lets you use existing documents as examples for further

HOW CLUSTERING WORKS

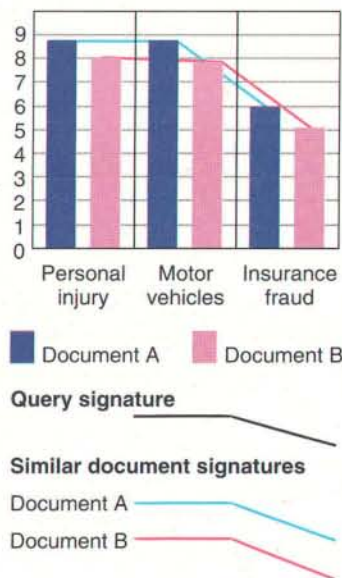

queries. This query-by-example process is valuable to novice users who can identify what they are looking for when they find it but are not comfortable with a query language environment.

Thus, document clustering is designed to assist those who cannot always formulate a comprehensive query or who are not well versed in the nature of the on-line document collection. It

Document clustering ranks documents according to their relevancy to the query. For example, Document A refers to an injury resulting from an automobile accident. Terms within this document are ranked on a scale of 0 through 9 against the subject categories of personal injury, motor vehicles, and insurance fraud, with the values 9, 9, and 6, respectively. Document B, referring to "an unfortunate incident involving an ambulance," may contain terms that are ranked 8, 8, and 5 against these same subjects. As a result, these documents will have similar signatures by which they are clustered together. When you submit a query, it will also be assigned a signature that is ranked against document signatures to determine relevancy. Based on the clustering approach being used, the documents found to be relevant can be used to find other documents with similar signatures.

offers a way to extract all the relevant information available in a database and avoid being buried under mountains of on-line data.

Thomas M. Koulopoulos is president of Delphi Consulting Group, a Boston-based consulting, research, and publishing group that focuses on text and image document management. You can reach him on BIX c/o "editors."

solution (untouched by human hands) called *full-text* indexing and retrieval. As text is presented in an electronic format, the machine generates a list of strings associated with each document. All discrete strings in a document (except those identified as noise strings) are inverted: listed in a predetermined order, with the list associated with a document identification number.

The full-text method is a straightforward, easily implemented solution. The primary issue in full-text indexing is managing the overhead—the lists of alphabetized strings. Most large document management systems use the full-text approach. Because these lists equal and sometimes exceed the storage required for the original text, the solution becomes expensive.

On the retrieval side, queries are handled on the basis of a *string-match* principle: Each indexed string in a query is matched with a string in the text. Documents are retrieved if there is a match. All the systems described above operate on the premise that you know exactly what you are looking for and that the text exists in the form you are seeking. These are concepts inherited from a tradition of managing data that doesn't translate directly to managing text. The DBMS (database management system) technology was not designed to address free text, which, unlike formatted data, is unstructured, unformatted, and may be about a particular subject. To further complicate the text management problem, queries will be ad hoc and differ from individual to individual.

Commercial Solutions

To alleviate the problems caused by the poor fit of database technology to text management, various techniques have been incorporated into commercial software. These will be discussed later in the context of identifying the critical-performance characteristics of systems to manage large collections of documents effectively.

Hardware-intensive solutions share many of the limitations of keyword technology. The most prevalent hardware-oriented approach is based on what is termed *free-text scan*. In the simplest terms, the entire document base is scanned for each query. No overhead is generated because there is no index. As the document base grows, additional hardware is added to expedite the search process.

continued

Searching Through J-Space

ITMS (Intelligent Text Management System) from Information Access Systems (Boulder, CO) is a full-text classification-and-retrieval system that automates the input, classification, retrieval of unstructured documents, and storage. ITMS integrates three retrieval strategies: formatted field, keyword, and intelligent retrieval.

The intelligence of ITMS is provided by a knowledge base called a JBM (judgment base module). The

JBM is developed through a human-judgment-simulation (judgment space, or *J-space*), the results of which are incorporated into the machine decision-making process. Subject fields and rated vocabulary make up a JBM.

Keyword and formatted-field queries are created with standard Boolean syntax. Intelligent-retrieval requests are typed in conversational language by requesting documents about or similar to a particular subject. ITMS presents

you with the combined results of keyword, formatted-field, and intelligent searches in the order of their overall relevance to a query. Text retrieval is based on an understanding of the subject matter of the document base that ITMS is managing. Thus, it can select documents that are conceptually similar to the query and list them in order of similarity. ITMS also automatically classifies text and highlights relevant subdocuments for quick reference.

On the horizon is a software-oriented technology designed for text management. This technology is called *document clustering* (see the text box "Document Clustering" on page 272).

Selectivity

The list of comparison points for evaluating text management systems begins with *selectivity*. Selectivity pertains directly to the most frequently voiced user's lament: information overload—the impossibility of finding what you need in the gigabytes of data available, weeding out extraneous material. At issue is not only your "futility point" but also your time constraints. How much time will you spend looking—trying one path and then another—before you reach the futility point and abandon the search altogether? How much time is wasted? What are you willing to settle for when you can't find exactly what you are seeking? How much time and money do you typically expend?

Essentially, the issue is how well any system is able to screen out text that does not meet or exceed a usefulness threshold value: Is it delivering relevant information? This ability becomes critical as the document base expands.

Each commercial product is subject to the particular limitations of the technologies on which it's built, but all have been enhanced to overcome these limitations. Vendors of keyword-based systems, for instance, have added enhancements to every aspect of the techniques by which term lists are created, stored, and retrieved. Early products addressed the query definition requirement for Boolean operators: combining word *x* with word *y* (known as

ANDing) and excluding "not word *z*." The assumption is that you can make a selection by specifying which words you wish to see in a retrieved document. Free-text scanning supports the Boolean retrieval method.

Unfortunately, what you specify in the "not" component of your Boolean search expression may well contain the information that you were trying to find with the "and" portion of the query. In spite of this limitation, the Boolean-request format remains a standard feature of most large-scale systems.

Other automated solutions (e.g., Fulcrum Technologies' Ful/Text) have an additive feature by which the frequency of a word enhances its retrieval. The assumption is that if a word is repeated it has more value. In the *unique-word* approach, a word is assumed to have greater retrieval power if it occurs the least amount of times in the text. And yet another variation of the fully automatic system is the *vector-space* approach, in which each document is represented by a vector of terms, each of which is represented by a positive number. To select documents for retrieval, the system performs similarity computations between the value of stored items and incoming queries. It ranks the retrieved items by how similar the word-count ratio is to that of the query. The vector-space approach is implemented on the Connection Machine (Thinking Machines, Cambridge, MA).

Thesaurus construction and manual (i.e., human) indexing provide an alternative to the full-text mode, although the underlying supporting technology in both modes is identical. With thesaurus construction and

manual indexing, overhead is reduced because only the thesaurus terms are inverted. Another advantage is that the people creating the index can apply intelligent selectivity by anticipating and standardizing the terms you might use in a query. Further, the structure of a thesaurus helps you find alternative paths to explore to find a precise request.

The notion of adding human intelligence to facilitate the search is carried a step further by Verity (Mountain View, CA) in its product Topic. You add your own intelligence by assigning weights to relationships between query terms (single or multiple word) and topics when you formulate the query. Not all terms in the request have to be present for the document to be grabbed; it need contain only some of the terms in the topical hierarchy. Documents are selected on the basis of a relevance score, using the weights that you specify. Although constructing topic trees is straightforward for a small single-user database, the process doesn't lend itself to large shared systems.

The document-cluster idea is not Boolean query afterthought. Instead, it's designed for text management, and many of the questions regarding selectivity become irrelevant because its fundamental hypothesis is that closely associated documents are relevant to the same request. The basic design goal of this approach is to limit the number of documents retrieved in response to a query to those contained in a given cluster of like documents. The retrieved documents are ranked in query-relevance order.

Document-cluster systems and full-text systems are at opposite ends of the spectrum

Developers: Lock Up Your Profits

Windows 3.0
Support Available

We have the key for protecting your software profits and your copyright.

Software piracy's a crime! What it can do to a developer's profit margin is shameful. The cost of development and marketing products demands you receive the revenue you are entitled to.

We have the solution.

- Custom hardware and software for each developer
- Encrypted interrogation routines and debug disablers. Over 140 language interfaces available.
- Available active read/write memory and on-board microprocessor provide the ultimate protection
- Keys for PC "compatibles," Macintosh, UNIX and RS-232C standard
- Total compatibility, reliability and end user satisfaction

We have the key.
Call us for more information
or a demonstration package.

1-800-843-0413



In EUROPE:
MICROPHAR, 122 Ave. Ch. De Gaulle 92200,
Neuilly-Sur-Seine, FRANCE, Tel: 33-1-47-38-21-21 Fax: 33-1-46-24-76-91

For Distributors in:

- * BELGIUM, E2S (091 21 11 17)
- * GERMANY, AUSTRIA: Microphar GmbH (06223 - 73730)
- * HUNGARY, Polyware Kft (76-22-307)
- * ITALY, Siosistemi (030 24 21 074)
- * POLAND, Microphar Poland (32 586 848)
- * PORTUGAL, HCR (1 56 18 65)
- * SCANDINAVIA, Microphar Nordic (45 53 51 70 33)
- * SPAIN, Microphar España (032 37 31 05)
- * SWITZERLAND, SAFE (024 21 53 86)
- * THE NETHERLANDS, Infotic (015 15 88 37)
- * UNITED KINGDOM, Clearsoft (091 378 91 91)

PROTECH
MARKETING, INC

9600-J Southern Pine Blvd.
Charlotte, NC 28217
Tel: 704-523-9500 FAX: 704-523-7651
Hours: Mon-Thurs: 8:30-7:00, Fri: 8:30-5:30 ET
Open late to better serve our west coast clients.
Se Habla Español

BYTE

BYTE Reprints

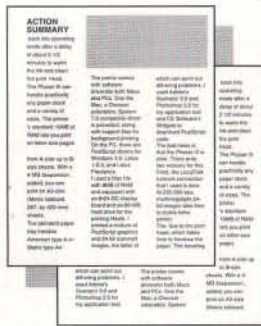

The BYTE Reprint

Department will provide free quotations for reprints of BYTE articles.

Reprints can serve as high quality, inexpensive promotional tools:

- Train and educate key personnel
- Present information at conferences/seminars
- Provide literature to users of your products

Call

603-924-2525

for information and a free price quotation.

Minimum order: 500



SEARCH AND RETRIEVAL

because the clustering capability requires human effort for development and maintenance. Although most clustering systems are in experimental stages, Information Access Systems (Boulder, CO) has developed a commercial product, ITMS (Intelligent Text Management System), out of its human-judgment-simulation technique (see the text box "Searching Through J-Space" on page 274).

Hardware-intensive solutions assume that selectivity is achieved through a character-by-character (or a surrogate) match of a text string in the query to one in the text—the longer the matched string, the more selectivity the system can achieve. A leading example of the character-by-character match is Gescan from Gescan International (Research Triangle, NC). Excalibur Technologies (Albuquerque, NM) uses a sophisticated representation schema for text and surrogate pattern matching. Documents containing similar information will be retrieved along with documents containing an exact match.

Precision/Recall Trade-off

What is the precision/recall trade-off? How much does the searching method cost the performance of the retrieval method? These are key questions. Traditionally, text management systems were evaluated by measuring how closely a delivery system was able to retrieve what the user was looking for (precision) and whether the system was able to get everything that was relevant to a user's request (recall).

In the fully automated implementations of keyword systems, the trade-off is inevitable: The more precise your query, the more likely it is that you will miss some relevant information because the list of terms used in the request does not appear in the text. After many trial-and-error passes, you may feel satisfied with the resulting document set and assume that all the documents pertaining to your subject matter have been found. Unfortunately, this is not usually the case; you have missed many documents because their authors didn't use the same keywords that you used when you described the subject of your query. The documents you're missing may contain the essential information you were seeking.

Techniques such as Boolean queries that use OR, fuzzy logic, associative searching, morphologies, neural networks, and *wild carding* are all methods of enhancing keyword-search technology to reduce the precision/recall trade-off. Each method has had some success in decreasing the chances of missing important documents, but they have reduced precision in the process.

Probabilistic pattern matching is a hard-

ware-oriented method that retrieves text holding the term that most closely matches the character-string pattern of the query term. In document-clustering systems, the precision/recall trade-off is addressed through their basic design: Documents that cluster around the subject of the query are returned in order of "relatedness" on the basis of their conceptual distance from the query.

Subdocument Retrieval Capability

Subdocument retrieval is primarily aimed at reducing the time the user spends reading through text to find something useful. If the document-retrieval system can place you right in the most relevant part of the documents that you have selected, your time will be spent productively.

The critical question is whether the document management system is able to automatically subdivide a document into sections that reflect changes in the focus of the subject. A section that is relevant to your query may amount to only two paragraphs in a 400-page document.

What to Expect

The list of subjects for evaluating textbases can go on and on. Be sure that the systems you're evaluating can have high-level indexes capable of identifying more than one subject per document and that your system can retrieve all the information on a subject. This may sound simplistic, but it's the most important concern you should have when evaluating systems.

Textbases are accumulating at an accelerating rate, as data links and input devices proliferate. Increasingly, users of these shared systems are not trained librarians but executives and professionals who want direct access to text-based information.

Gigabyte-size document bases are literally bursting the seams of the hand-me-down trappings of their predecessor, the database. Text must be fitted with a technology suited to its nature if it's ever to take its place in the world and fulfill our expectations of its potential. ■

BIBLIOGRAPHY

- Blair, David C. *Language and Representation in Information Retrieval*. New York: Elsevier Press, 1990.
- Delphi Consulting Group. *Information Management: Next Generation*, Boston, 1991.

Earlene Busch is the president of Information Access Systems (Boulder, CO). She writes and speaks frequently on knowledge management systems. You can reach her on BIX c/o "editors."

Two ways to plant a tree for Global ReLeaf

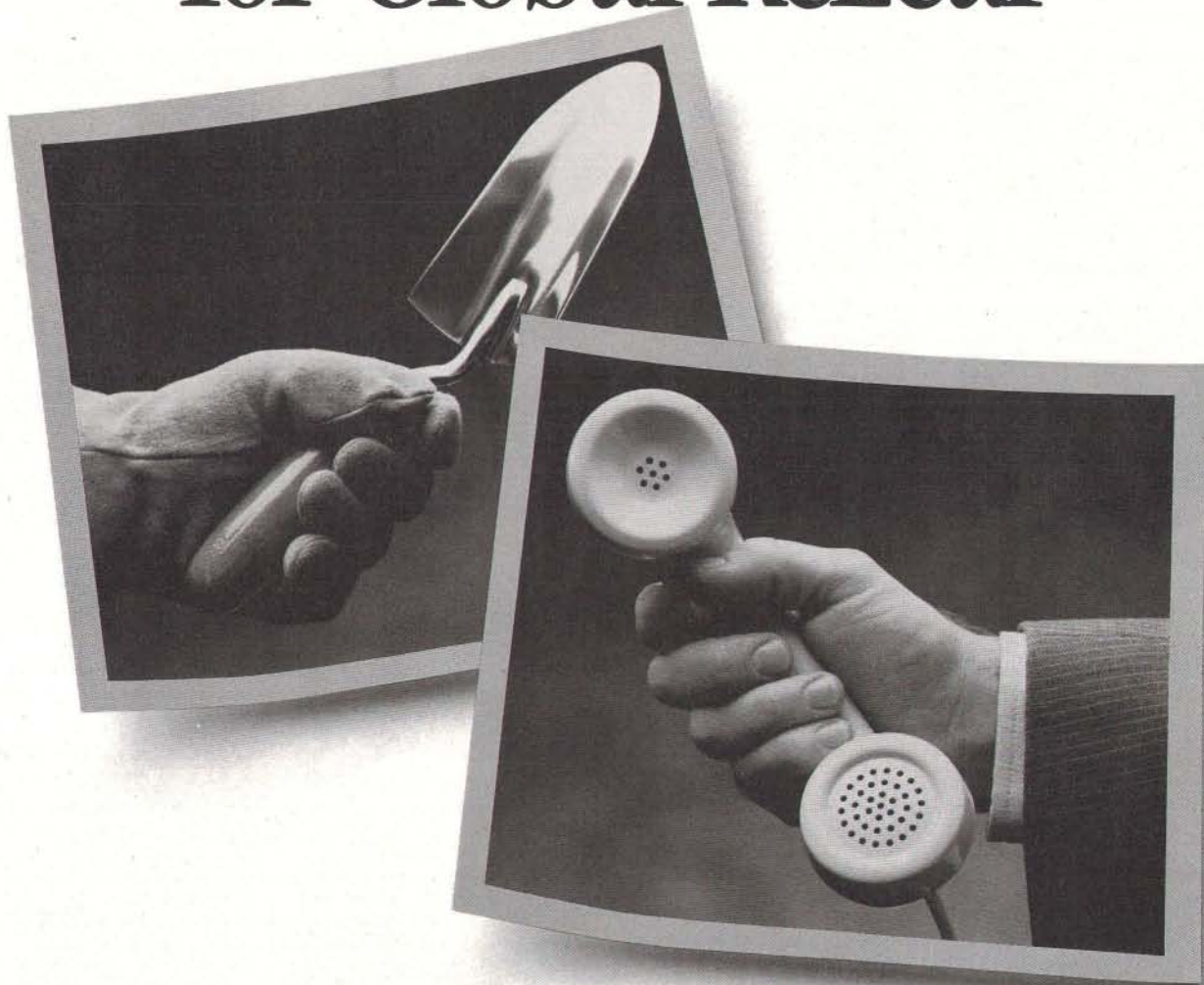

Now there are two ways you can plant a tree for Global ReLeaf. You can dig in and do it yourself. Or, you can pick up the phone and dial 1-900-420-4545.

You see, even a single tree can make an important difference in the kind of world we live in and the kind of future we leave behind. Trees provide shade, help keep our air and water clean, and reduce

heat-trapping CO₂ in the earth's atmosphere, which is a major factor in global warming.

That's why we've made it easy for you to do your part for Global ReLeaf. When you call our special Action Line, the \$5.00 charge actually pays for planting a tree while supporting Global ReLeaf action across the country. And, we'll also rush you detailed

information on Global ReLeaf. So, pick up the phone and start planting. Earth needs all the trees you can plant. And that's why we need you.

**GLOBAL
RELEAF**

The American Forestry Association
P.O. Box 2000, Washington, DC 20013

1-900-420-4545

Citizens caring for trees & forests since 1875

The best got better.

SYSTAT 5.0's new menus make the top-rated statistical program even easier to use.



v 4.1



SYSTAT is the *only* package to receive these three awards.

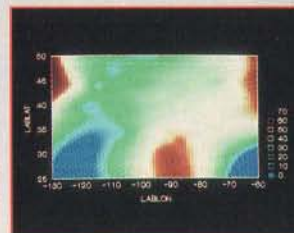
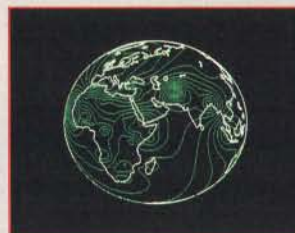
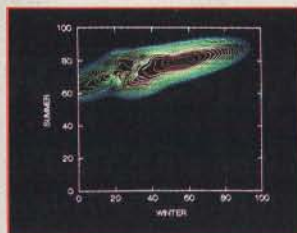
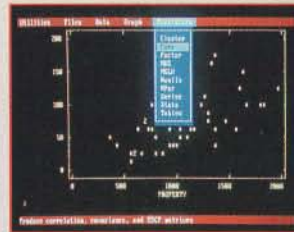
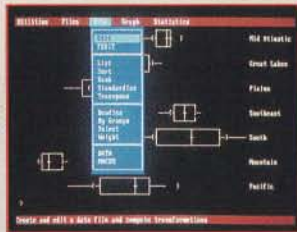

New Features Menus or commands — your choice. Rewritten documentation includes statistics tutorials. Fast, built-in drivers for SYGRAPH. Global mapping and many new plots. Multi way repeated measures. Means model for missing cells designs. Post-hoc tests. Interactive stepwise regression.

Statistics Basic statistics, frequencies, t-tests, post-hoc tests. Multi way crosstabs with log-linear modeling, association coefficients, PRE statistics, Mantel-Haenszel, asymptotic standard errors. Nonparametric statistics (sign, runs, Wilcoxon, Kruskal-Wallis, Friedman two-way ANOVA, Mann-Whitney U, Kolmogorov-Smirnov, Lilliefors, Kendall coefficient of concordance). Pairwise/listwise deletion of missing values, Pearson correlation, SSCP, covariance, Spearman, Gamma, Kendall Tau, Euclidean distances, binary similarities. Linear, polynomial, multiple, stepwise, weighted regression with extended diagnostics. Multivariate general linear model includes multi way ANOVA, ANCOVA, MANOVA, repeated measures, canonical correlation. Principal components, factor analysis, rotations, components scores. Multidimensional scaling. Multiple and canonical discriminant analysis, Bayesian classification. Cluster analysis (hierarchical, single, average, complete, median, centroid linkage, k-means, cases, variables). Time series (smoothers, exponential smoothing, seasonal and nonseasonal ARIMA, ACF, PACF, CCF, transformations, Fourier analysis). Nonlinear estimation (nonlinear regression, maximum likelihood estimation, and more).

Graphics Overlay plots. Drivers for most graphics devices. Two-dimensional: Error bars. Scatterplots. Line and vector graphs. Vector, dot, bubble and quantile plots. Bar graphs (single, multiple, stacked, range). Box plots (single and grouped). Stem-and-leaf diagrams. Linear, quadratic, step, spline, polynomial, LOWESS, exponential smoothing. Confidence intervals and ellipses (any alpha value). Smooth mathematical functions. Rectangular or polar coordinates. Log and power scales. ANOVA interaction plots. Histograms (regular, cumulative, fuzzy). Stripe and jitter plots. Gaussian histogram smoothing. Scatterplot matrices. Voronoi

tesselations. Minimum spanning tree. Maps with geographic projections (U.S. state boundary file included, county and world boundary files available). Chernoff faces. Star plots. Fourier plots. Pie charts. Contour plots on regularly and irregularly spaced points. Control charts and limits. Three-dimensional: Data plots. Smooth function plots. Vector plots. Linear, quadratic, spline, least squares surface smoothing. Typefaces that print in perspective.

Data Management Import/export Lotus, dBase, and DIF files. Full screen data editor. Full screen text editor. Unlimited cases. Missing data, arrays, character variables. Capability to process hierarchical, rectangular or triangular files, irregular length records. Character, numeric, and nested sorts. Merge and append large files. Unlimited numeric and character variable transformations. Subgroup processing with SELECT and BY. Value labels and RECODE statements. Macro processor with programming language, screen control, file manipulation, applications generation, and report writing.

SYSTAT operates on IBM PC's® and compatibles, MS-DOS®, VAX®/Microvax and Macintosh®. Site licenses, quantity prices and training seminars available. No fees for technical support.



SYSTAT. Intelligent software.

For more information call or write: SYSTAT, Inc. 1800 Sherman Avenue, Evanston, Illinois 60201-3793 Tel: 708.864.5670 Fax: 708.492.3567
 For international representatives call: **Australia** 61.3.4974755, **Canada** 416.424.1700, **Finland** 358.0.6923800, **France** 33.1.40935000,
Germany 49.61.265950, **Italy** 39.587.213640, **Japan** 81.3.5902311, **New Zealand** 64.71.562675, **Norway** 47.3.892240, **Sweden** 46.8.110620,
Switzerland 41.31.416611, **The Netherlands** 31.3402.66336, **UK:** Letchworth 44.462.482822, London 44.81.6926636, London SE 44.0753.841686

For IBM/compatible information circle 161; For Macintosh information, circle 162 on Inquiry Card.

SGML FREES INFORMATION

Escape a world where there is too much data and go to a place where you can access the information hidden within it

HAVILAND WRIGHT

In the 1980s, desktop publishing emerged as a way for computers to manipulate the *look* of a document. After a decade of widespread adoption of these tools, however, the *information* in documents is largely inaccessible by computer. The challenge of the 1990s is to transform documents into information that has an impact on productivity and innovation.

The word *document* once conjured up images of large, legal-looking sheaves of paper that were guaranteed to gather dust. Now, it's a general term that covers faxes, E-mail, user's manuals, journal articles, and bulletin-board notes. In addition, there are analogies between documents and business presentations, interactive computer sessions, hyperlinked multimedia collections, and musical performances. Each of these new forms of documents shares a common thread—the use of organizing themes—that can trace its ancestry to the original concept of what a document is.

It's one thing to see commonalities between forms of documents and quite another to make use of them. The rise of the SGML (Standard Generalized Markup Language) has corresponded to and contributed to the evolution of the concept of a document from a physical reality to a processing metaphor for many different information-bearing forms. As a language for expressing context-free document descriptions, SGML offers a way to productively put to use the similarities among these various expressions.

SGML is best known for its use in large-scale standardization efforts, such as the Department of Defense's CALS (Computer-Aided Acquisition and Logistics Support) program and the ongoing work of



the Air Transport Association and the Telecommunications Industry Forum. It's important to realize, however, that other SGML-based systems are also in operation today.

Developers and systems integrators who manage large volumes of documents and exchange information among various hardware platforms and software packages use SGML to encode document information. Those who ignore SGML often must reinvent its key features to achieve their objectives. SGML applications can provide the necessary structure for exchanges that support communities of mutual interest, even when they involve many participants and several human languages.

SGML works because it's simple. Like any other language, it requires detailed knowledge for systems implementation. But you must know only a few basics to use SGML or to understand its implications.

Why Use Markup?

In the world of paper documents, *markup* refers to the way an editor, colored pencil in hand, annotates manuscripts with typographic specifications and other presentation notes. In electronic-document files, markup usually appears as tags, or codes, interspersed with the text and other material in a document. Electronic-publishing systems, full-text databases, hypertext and hypermedia systems, and other document-oriented applications require files that contain both content and markup.

Markup separates a document's logical elements and may specify what functions are to be performed on them. A markup tag for a paragraph, for example, might indicate where the paragraph begins,

whether or not to indent the first line, and what typeface to print it in. Markup provides the structure and procedural information that you need to print and manipulate documents.

Taken as a whole, an application's tagging vocabulary expresses its functional capabilities. You don't need tags for table rows, columns, and cells, for example, if your word processor can only set tables with tabs.

Historically, markup has been product-specific, and its languages have been as varied as the products they have supported. Few popular products give you access to explicit markup. Word processors buffer you from it with WYSIWYG interfaces. Products that support explicit code editing often transform those codes into other forms of markup as they produce document files. Still other products obscure the code with complex file structures. And there are both ASCII and non-ASCII markups.

These issues aside, you can generally classify markup languages as either *procedural* or *descriptive*. The tagging vocabulary of a procedural markup language expresses the actions you must perform on a document's content to achieve the desired appearance. The procedural markup in figure 1 provides a detailed, top-to-bottom script, often repeating the same sequences.

On the other hand, descriptive markup tags identify logical units of text. By itself, descriptive markup doesn't address how a document looks. In figure 1, however, there is an obvious mapping from the descriptive markup in the left margin to the procedural detail in the right margin. This mapping is the essence of a *style sheet*, which uses descriptive names for detailed procedural scripts.

Although they simplify document markup, style sheets don't necessarily contain much information about the document itself. They generally address document components one at a time, leaving the overall document structure implicit. More important, style sheets rarely contain descriptors that suggest how you can use the information in a document. To free the information in figure 1 from the page, you need new descriptions: an expanded descriptive tagging vocabulary.

Flexibility Is the Key

SGML is a programming language designed to write tagging systems. Because most SGML programs are compatible with a variety of applications, SGML markup is almost always descriptive. An SGML application program called a DTD (document type definition) defines *classes* of

documents. Each document *instance* in a DTD class is tagged as a hierarchy of nested elements.

Although you can control how the tags look in SGML markup, the default is to use angle brackets as tag delimiters, so angle-bracketed tags are strongly associated with SGML. More important, however, is your ability to choose the names for element tags and document structures. In figure 2, for example, the element tagged CHAPTER CHAPNUM="NINETEEN" CTITLE="VINCENT SERVING" consists of a paragraph and two sections. Each of these constituent elements is composed of text and/or other elements.

Figure 2 shows an SGML application that tags the surface structure of the page shown in figure 1. The document's visual appearance implies its nested structure, and the style-sheet component names reinforce that structure. Although style sheets treat documents as sequences of text blocks in a flat-document approach, SGML-tagged documents are explicit, related hierarchies of named objects.

The tags in figure 2 mark the document structure, and some of them contain additional information about the elements they delimit. The CHAPTER and SECTION tags, for example, contain titles and numbers. The LABITEM tags contain labels. These additional information items are known as SGML *attributes*.

The DTD defines attributes as information items related to specific elements. An attribute definition names each information item to be associated with an element and assigns it a data type. In the DTD for figure 2, for example, the attribute name for LABITEM is LABEL, and the type is character data. When tagging an element, you include the attribute names and values in the tag itself.

DTDs that define the surface structure of a class of documents can support an array of presentations, applications, and translations. In figure 2, the tags alone contain enough information to build a detailed table of contents. Translating the document for outline processing requires exactly the same information encoded in the document hierarchy. If tag assignments to typographic styles are made in a context-dependent manner, paper publishing becomes quite flexible.

As an applications language, SGML has powerful facilities for coordinating various documentary material. DTDs can include provisions for graphics files, PostScript printing, or special processing codes for mathematics. Applications can also include character sets to support virtually any national language or special typography.

BYTE ACTION SUMMARY

Today, a document may have a longer life than anticipated, occur in a variety of forms and pieces, and interact with systems that didn't even exist when it was created. For important documents, it's not adequate simply to view and print them. SGML gives you a flexible way to access the information hidden within those documents.

TYPES OF MARKUP

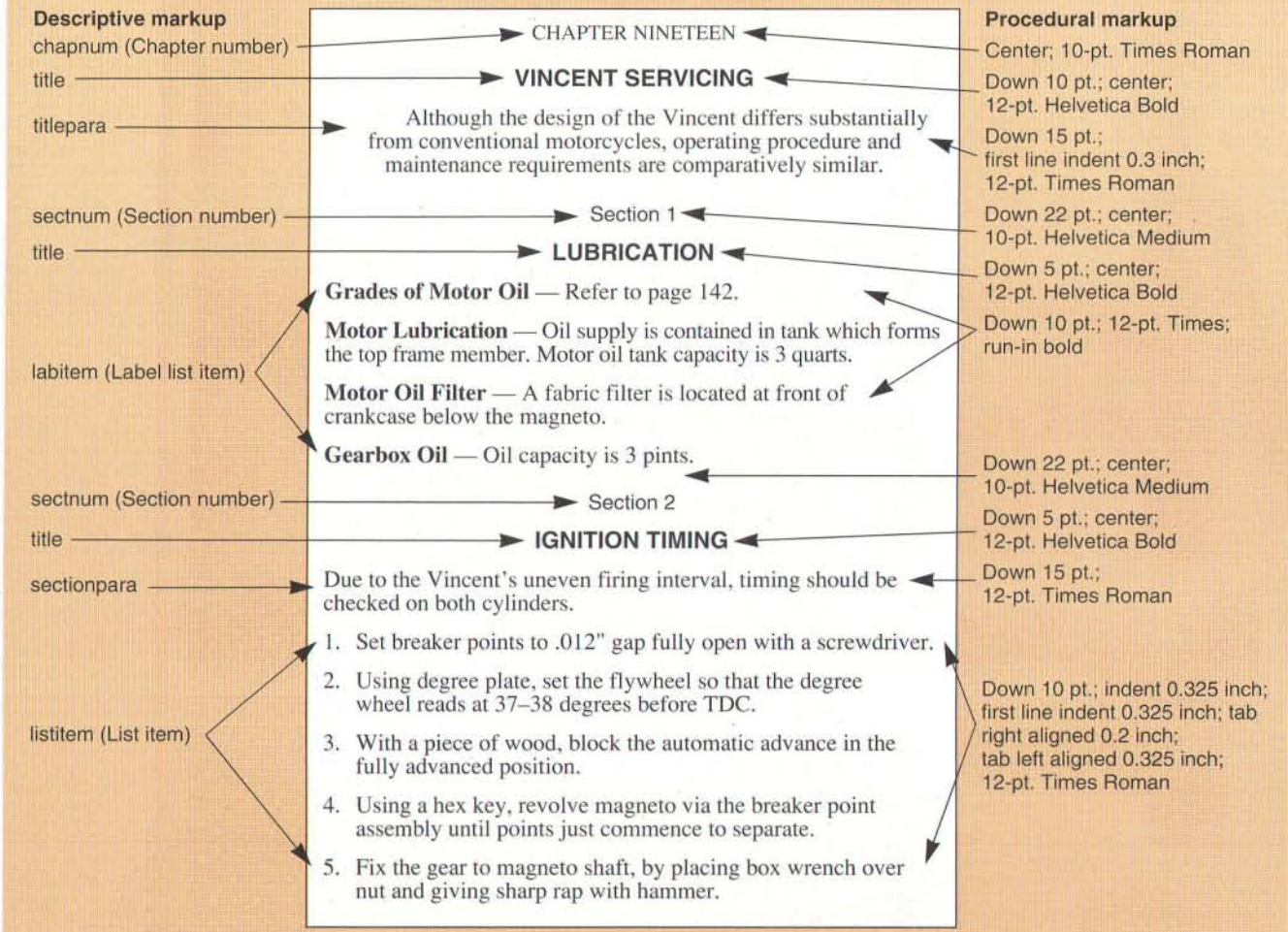

Figure 1: This page is marked up with simplified versions of both procedural and descriptive markup languages. Note the mapping between the two languages; it forms the essence of a style sheet. The text appearing on the page was taken from Modern Motorcycle Mechanics (Nicholson Brothers Motorcycles, Ltd., 1974).

You can use SGML applications to coordinate collections of documents by structuring references to external files. In addition, you can tag document instances with sections to be conditionally included or ignored. As a process-independent language, SGML lets you validate any document instance before beginning potentially costly subsequent processing.

The advantage of SGML applications is their flexibility, even when they encode only the surface characteristics of documents. In the age of computers, a document can have a longer life than anticipated, have various appearances, be excerpted for many reasons, and interact with systems that didn't even exist when it was created. For documents of value, it will never be adequate simply to view and print them. The more flexible your docu-

ment-handling systems are, the more value you can derive from the documents you produce.

Turning on the Power

Applications exploit the power of SGML when they define documents as *information resources*. As such, DTDs often describe document classes in which document instances are similar in information content. Figure 3 retags the page that appears in figure 1. Although the document's surface structure is still apparent, the tagging now emphasizes information content.

The tagging in figure 2 addresses the *physical* document structure. The tagging in figure 3 deals with the *logical* information structure, and its DTD assumes that this is one of many service chapters that contain similar information about other

motorcycles. Each chapter contains lubrication information and procedures for ignition timing. You can still create a printed version of the chapter, but the new method of tagging enhances your ability to do other, more interesting things with this information.

Attributes now express much of the information that the text previously conveyed. The tags in the first section of figure 3 relate the page's purpose: to provide lubrication information. The first item explicitly tags the cross-reference as CROSS-REF with an attribute named TARGET, which is set equal to page 142. Tank capacities have CAPACITY tags with attributes that note the appropriate type of capacity units. The second section tags the cautionary lead paragraph as a NOTE. Each step contains tagged key values and tools.

continued

*I don't know doctor, ever
since we've made this acquisition,
I've been seeing double!!*



Turn your **excess inventory** into
a substantial tax break and help
send needy **kids to college** as well.

Call for your **free guide** to learn how
donating your slow moving inventory can mean
a generous **tax write off** for your company.

Call (708) 690-0010

Peter Roskam

Executive Director



P.O. Box 3021, Glen Ellyn, IL 60138 FAX (708) 690-0565

Excess inventory today...student opportunity tomorrow

THE DIFFERENCE A TAG MAKES

```

CHAPTER [BIKETYPE="Vincent"]
INTRO Although the design of the Vincent differs substantially from conventional motorcycles,
operating procedure and maintenance requirements are comparatively similar. </INTRO

LUBE
SUPPLIES
ITEM Grades of Motor Oil </ITEM
DETAIL <CROSSREF [TARGET="PG142"] </CROSSREF </DETAIL
ITEM Motor Lubrication </ITEM
DETAIL Oil supply is contained in tank which forms the
LOCATION top frame member. </LOCATION Motor oil tank capacity is
CAPACITY [UNITS="QUARTS"] 3. </CAPACITY </DETAIL
ITEM Motor Oil Filter </ITEM
DETAIL A fabric filter is located at
LOCATION front of crankcase below the magneto. </LOCATION </DETAIL
ITEM Gearbox Oil </ITEM
DETAIL Oil capacity is
CAPACITY [UNITS="PINTS"] 3. </CAPACITY </DETAIL
</SUPPLIES
</LUBE

TIMING
NOTE Due to the Vincent's uneven firing interval, timing should be checked
on both cylinders. </NOTE

METHOD
STEP [ ] [ PARA Set breaker points to [POINTGAP] [UNITS="INCHES"] .012 </POINTGAP fully open with a
TOOL screwdriver. </TOOL </PARA </STEP
STEP [ ] [ PARA Using [TOOL] degree plate, </TOOL set the flywheel so that the degree wheel reads at
KEYVALUE [UNITS="DEGREES"] 37-38 </KEYVALUE before TDC. </PARA </STEP
STEP [ ] [ PARA With a piece of wood, block the automatic advance in the fully advanced position.
</PARA </STEP
STEP [ ] [ PARA Using a [TOOL] hex key, </TOOL revolve magneto via the breaker point assembly
until points just commence to separate. </PARA </STEP
STEP [ ] [ PARA Fix the gear to magneto shaft, by placing [TOOL] box wrench </TOOL over nut
and giving sharp rap with [TOOL] hammer. </TOOL </PARA </STEP

</METHOD
</TIMING

</CHAPTER

```

Figure 3: Putting a different set of tags on the page in figure 1 changes things. Although the document's surface structure is still apparent, the tagging now emphasizes the document's logical information content.

to have extensive technical knowledge of SGML. Others offer you a choice between a nearly WYSIWYG interface and explicit tag editing. SGML-specific editors provide a powerful way to check documents for conformance to the document style and to edit the details of a tagged-document instance.

An SGML system should include an SGML parser or an SGML-specific editor that can check documents for DTD compliance. I used one such author/editor from SoftQuad (Toronto, Ontario, Canada), for all the SGML examples in this article.

Most new system implementations include a conversion stage. An SGML system is no different than the new systems and usually requires two kinds of conversions: back-file conversion for existing documents and new-file conversion for ongoing document interchange with external sources. An important difference between the two is that back-file conversions are very often concentrated, highly visible efforts, and new-file conversions are widely dispersed and often go unnoticed.

SGML conversion is rarely a matter of code-for-code translation. The markup in

source documents is often not detailed enough to support a straight translation into an SGML application. This means you must determine SGML tags that have no source-file equivalents in much the same way that you infer the structure of the document in figure 1 from its visual appearance. In fact, this is exactly how Fasttag from Avalanche Development (Boulder, CO) determines document structure.

A growing number of software packages support SGML and don't require translation of SGML document instances before you run them. Usually, however,

CSS: STATISTICA

CSS/3™ Complete Statistical System with over 1,000 presentation-quality graphs fully integrated with all procedures and on-screen graph customization ■ The largest selection of statistics in a single system; in-depth, comprehensive implementations of: *Exploratory techniques; multi-way tables with banners; nonparametrics; distribution fitting; multiple regression; general nonlinear estimation; logit/probit analysis; general ANCOVA/MANCOVA; stepwise discriminant analysis; log-linear analysis; factor analysis; cluster analysis; multidimensional scaling; canonical correlation; item analysis/reliability; survival analysis; time series modeling; forecasting; lags analysis; quality control; process analysis; experimental design (with Taguchi);* and much more ■ Manuals with comprehensive introductions to each procedure and examples ■ Integrated Stats Advisor expert system ■ Extensive data management facilities (powerful spreadsheet with formulas; relational merge; data verification; flexible programming language) ■ Optimized (plain English menus/mouse) user interface: even complex analyses require just few self-explanatory selections (CSS can be run without manual; Quick Start booklet explains all basic conventions) ■ Macros, batch/commands also supported ■ All output displayed in Scrollsheets™ (dynamic tables with pop-up windows and instant graphs) ■ Extremely large analysis designs (e.g., correlation matrices up to 2,000x32,000) ■ Unlimited size of files; extended precision; unmatched speed (Assembler, C) ■ Exchanges data (and graphics) with many applications (incl. Excel®, Lotus 3®, dBASE IV®, SPSS®) ■ Highest resolution output on practically all printers (incl. HP, Postscript), plotters, recorders, typesetters ■ IBM compatibles, 640k or more ■ Price: **\$595.**

Quick CSS™ Subset of CSS/3: all basic statistical modules (incl. data management) and the full, presentation-quality graphics capabilities of CSS/3 ■ Price: **\$295.**

CSS:GRAPHICS™ A comprehensive graphics/charting system with data management ■ All graphics capabilities of CSS/3 and, in addition, extended on-screen drawing, 19 scalable fonts, special effects, icons, maps, multi-graphics management ■ Hundreds of types of graphs ■ Interactive rotation and interactive cross-sections of 3D graphs ■ Extensive selection of tools for graphical exploration of data; fitting; smoothing; spectral planes; overlaying; layered compressions; marked subsets ■ Unique multivariate (e.g., 4D) graphs ■ Facilities to custom-design new graphs and add them permanently to menu ■ Import/export of graphs and data, 15 formats ■ Optimized (menu/mouse) user interface; even complex graphs require few keystrokes: all graphs on this page can be produced from raw data in less than 20 minutes ■ Macros, batch/commands also supported ■ Unlimited size of files ■ Highest resolution output on all hardware (see CSS/3) ■ IBM compatibles, 640k or more ■ CSS:GRAPHICS is included in CSS:STATISTICA (available separately for **\$495**).

Megafile Manager™ Comprehensive analytic data base management system ■ Unlimited size of files (up to 32,000 fields or 8 MB per record) ■ Megafile Manager is included in CSS/3 and CSS:STATISTICA (separately: **\$295**).

CSS:STATISTICA™ A fully integrated system that combines all the capabilities of CSS/3 and CSS:GRAPHICS into a single extremely comprehensive data analysis system ■ Price: **\$795.**

Domestic sh/h \$7 per product; 14-day money back guarantee.

Circle 155 for DOS. Circle 156 for MAC.

StatSoft™

2325 E. 13th St. • Tulsa, OK 74104 • (918) 583-4149
 Fax: (918) 583-4376

Overseas Offices: Statsoft of Europe (Hamburg, FRG), ph: 040/4200347, fax: 040/4911310; StatSoft UK (London, UK), ph: 0462/482822, fax: 0462/482855; StatSoft Pacific (Melbourne, Australia), ph: (03) 663 6580, fax: (03) 663 6117; StatSoft Canada-CCO (Ontario), ph: 416-849-0737, fax: 416-849-0918; Available From: CORPORATE SOFTWARE and other Authorized Representatives Worldwide: Holland: MAB Julsing, 071-230410; France: Version US (1) 40590913; Sweden: AkademiData 018-240035; Hungary: P&D Soft KFT 185-6868; Belgium: TEXMA 10 61 16 28; South Africa: Osiris 12 663-4500; Japan: SOFEL Co. 03-3251 1195.

CSS, CSS/3, CSS:GRAPHICS, Megafile Manager, Quick CSS, STATISTICA, StatSoft, dBase IV, Excel, Lotus, MacDraw, Macintosh, Postscript are trademarks of their respective companies; SPSS is a registered trademark of SPSS, Inc.

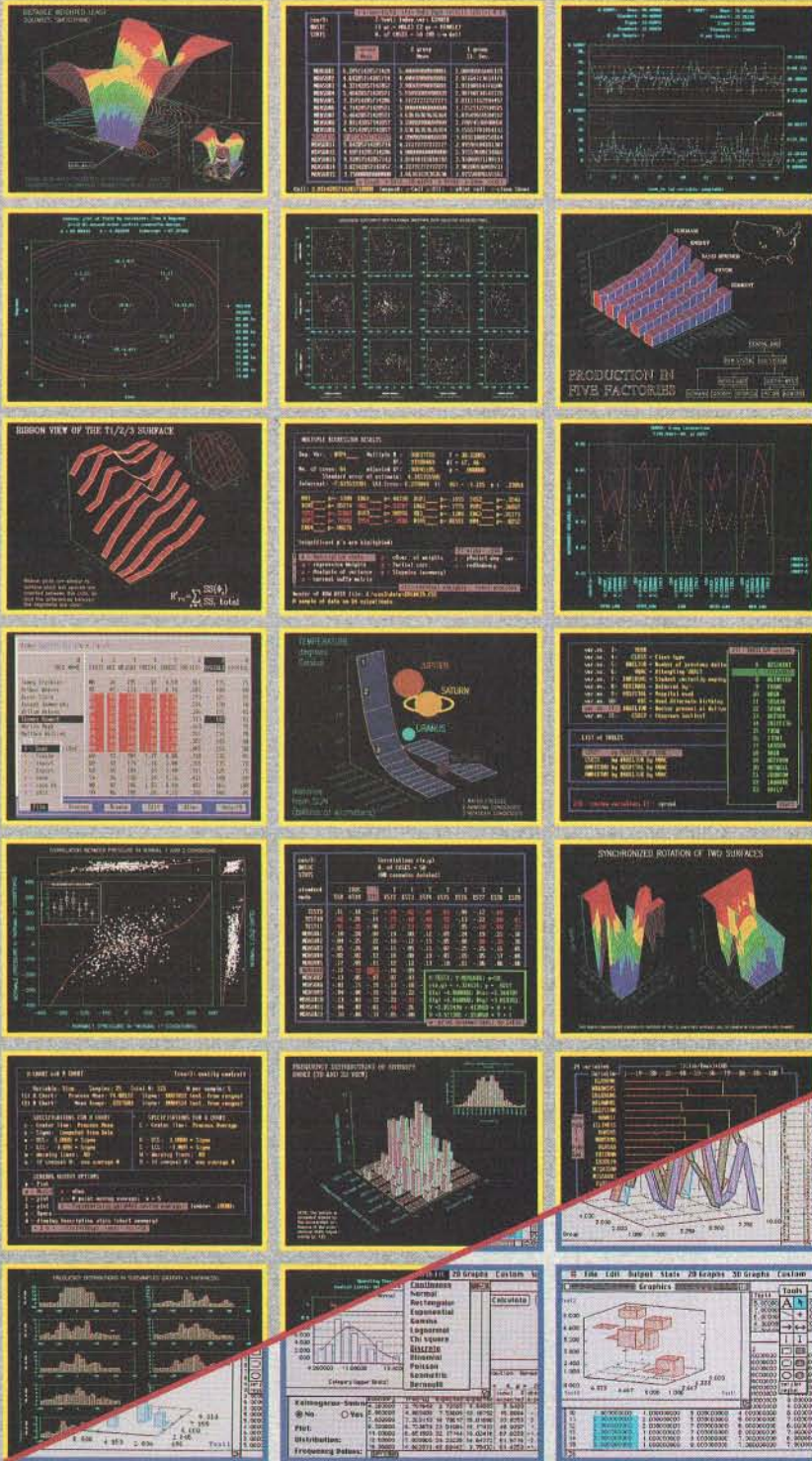

STATISTICA/Mac™ A CSS-compatible, comprehensive data analysis and graphics system designed for the Macintosh ■ Large selection of statistical methods fully integrated with presentation-quality graphics (incl. EDA, multiplots, a wide selection of interactively rotatable 3D graphs; MacDraw-style tools) ■ Unlimited size of files ■ Exchanges data with Excel and other applications ■ Price: **\$495.**

Quick CSS/Mac™ A subset of STATISTICA/Mac: all basic statistical modules and the full, presentation-quality graphics capabilities of STATISTICA/Mac ■ Price: **\$295.**

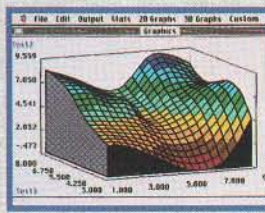

SUBSCRIPTION PROBLEMS?



We want to help!

If you have a problem with your BYTE subscription, write us with the details. We'll do our best to set it right. But we must have the name, address, and zip of the subscription (new and old address, if it's a change of address). If the problem involves a payment, be sure to include copies of the credit card statement, or front and back of cancelled checks. Include a "business hours" phone number if possible.

BYTE MAGAZINE

ATTN: SUBSCRIBER SERVICE
P.O. Box 555
HIGHTSTOWN, NJ 08520

SGML FREES INFORMATION

they require a setup to attach the appropriate processing methods to the elements defined in the DTD.

To process SGML document instances with a non-SGML process, you must translate the document-instance tagging into the markup that the non-SGML process supports. Systems like Avalanche's SGML Hammer create markup for target systems on the basis of the SGML DTD and a translation program.

Popular Misconceptions

Misunderstandings about SGML are widespread. To some extent, this is the fault of the SGML community. Even though SGML, like other languages, involves a lot of detail, the SGML glitterati are absorbed in the use of this detail as intellectual flak against the uninitiated.

Here are a few guidelines to help you avoid some of the most common misconceptions about SGML.

- Don't confuse an SGML application with SGML itself. In an SGML application, you create the tag names. They aren't part of the SGML specification. Broad applications (e.g., the Association of American Publishers and the CALS applications) are sometimes presented as though they were SGML itself.
- Be cautious of document systems that are described as being "SGML-like." Non-SGML systems may have markup with angle-bracket tag delimiters, use header files, and utilize a concept of document structure, but none of these things by themselves make an application SGML-compliant.
- SGML is not just a document-interchange language. Although SGML is a logical choice for writing document-interchange applications, it's more than an interchange language.
- Adopting SGML doesn't mean that your documents will automatically be compatible with any other SGML system. Another SGML system should be able to read your document instances, but it won't be set up for your DTDs.

Work Smarter

Work in SGML is ongoing. Much progress has been made on a standard SGML application called HyTime for Hypermedia. The Electronic Publishing Special Interest Group has begun to refine its SGML application for markup of complex mathematics and tables. And the International Organization for Standardization (Geneva, Switzerland), a worldwide federation of national standards bodies, has issued a draft international standard for the DSSSL (Document Style, Semantics, and Speci-

fication Language) that provides a standard architecture for formatting specifications.

The fundamental message of SGML is that your documents can stop being overhead and start contributing to productivity and innovation. The paper-document trap isn't a file cabinet filled with stuff no one will ever read, and it isn't the cost of printing and shipping documentation that is 90 percent redundant with telephone support. Paper documents (and their electronic equivalents) trap and smother the information, know-how, feedback, product ideas, and market intelligence that can help your department, company, or agency work better and work smarter. SGML is one of the tools that can help free that information. ■

BIBLIOGRAPHY

- EPSIG News* (newsletter of the Electronic Publishing Special Interest Group).
Goldfarb, Charles F. *The SGML Handbook*. New York: Oxford University Press, 1991.
TAG, The Technical Journal of the SGML Community.
Van Herwijnen, Eric. *Practical SGML*. Norwell, MA: Kluwer Academic Publishers, 1990.

Haviland Wright is president of Avalanche Development (Boulder, CO). You can contact him on BIX c/o "editors" or on Internet at haviland@avalanche.com.

FOR MORE INFORMATION

Graphic Communications Association

100 Daingerfield Rd.
Alexandria, VA 22314
(703) 519-8157

Circle 1000 on Inquiry Card.

Internet NetNews (an on-line SGML conference)

comp.text.sgml

Circle 1001 on Inquiry Card.

SGML Users' Group, c/o Database Publishing Systems, Ltd.

Public domain parser available from Ms. Gaynor West
608 Delta Business Park,
Great Western Way
Swindon, Wiltshire SN5 7XF, U.K.
44-793-512515
fax: 44-793-512516

Circle 1002 on Inquiry Card.

Search and Retrieval Systems

This type of software lets you create text databases or search your documents in place on a hard disk or across a network. It comes in a variety of prices, with numerous functions and capabilities. The following companies may have just what you need.

askSam Systems

P.O. Box 1428
Perry, FL 32347
(904) 584-6590
fax: (904) 584-7481
Circle 1146 on Inquiry Card.

Blackwell Scientific Publications

Osney Mead
Oxford OX2 0EL
U.K.
44-865-240201
fax: 44-865-791738
Circle 1147 on Inquiry Card.

BRS Software Products

8000 Westpark Dr.
McLean, VA 22102
(703) 442-3870
fax: (703) 827-0686
Circle 1148 on Inquiry Card.

Cincom Systems, Inc.

2300 Montana Ave.
Cincinnati, OH 45211
(800) 543-3010
(513) 662-2300
fax: (513) 481-8332
Circle 1149 on Inquiry Card.

CPT Office Systems, Inc.

8100 Mitchell Rd.
Eden Prairie, MN 55344
(612) 937-8000
fax: (612) 937-1858
Circle 1150 on Inquiry Card.

Cucumber Information Systems

5611 Kraft Dr.
Rockville, MD 20852
(301) 984-3539
fax: (301) 468-2920
Circle 1151 on Inquiry Card.

Expansion Programs International, Inc.

11115 Edgewater Dr.
Cleveland, OH 44102
(216) 631-8544
fax: (216) 281-0828
Circle 1152 on Inquiry Card.

Folio Corp.

2155 North Freedom Blvd.,
Suite 150
Provo, UT 84604
(800) 543-6546
(801) 375-3700
fax: (801) 374-5753
Circle 1153 on Inquiry Card.

Gescan International, Inc.

P.O. Box 12599
Research Triangle Park, NC
27709
(800) 982-2177
(919) 460-3100
fax: (919) 467-8427
Circle 1154 on Inquiry Card.

Golden Bow Systems, Inc.

842 Washington St.,
Suite B
San Diego, CA 92103
(800) 284-3269
(619) 298-9349
fax: (619) 298-9950
Circle 1155 on Inquiry Card.

Group L Corp.

P.O. Box 106
Hillsboro, VA 22132
(800) 672-5300
(703) 668-6655
Circle 1156 on Inquiry Card.

Henco Software, Inc.

100 Fifth Ave.
Waltham, MA 02154
(617) 890-8670
fax: (617) 890-7671
Circle 1157 on Inquiry Card.

I-Mode Retrieval Systems, Inc.

7 Odell Plaza
Yonkers, NY 10701
(914) 968-7008
fax: (914) 968-9187
Circle 1158 on Inquiry Card.

Infodata Systems, Inc.

5205 Leesburg Pike,
Suite 700
Falls Church, VA 22041
(703) 578-3430
fax: (703) 578-4516
Circle 1159 on Inquiry Card.

Information Access Systems, Inc.

4775 D Walnut St.
Boulder, CO 80301
(303) 442-6224
fax: (303) 442-4530
Circle 1160 on Inquiry Card.

Information Dimensions, Inc.

5080 Tuttle Crossing Blvd.
Dublin, OH 43017
(800) 328-2648
(614) 761-8083
fax: (614) 761-7290
Circle 1161 on Inquiry Card.

IntelligenceWare, Inc.

5933 West Century Blvd.
Los Angeles, CA 90045
(213) 216-6177
fax: (213) 417-8897
Circle 1162 on Inquiry Card.

Johnston & Co.

P.O. Box 446
American Fork, UT 84003
(801) 756-1111
fax: (801) 756-0242
Circle 1163 on Inquiry Card.

KnowledgeSet Corp.

888 Villa St., Suite 410
Mountain View, CA 94041
(800) 456-0469
(415) 968-9888
fax: (415) 968-9962
Circle 1164 on Inquiry Card.

Micro Dynamics, Ltd.

8555 16th St., Suite 700
Silver Spring, MD 20910
(301) 589-6300
fax: (301) 589-3414
Circle 1165 on Inquiry Card.

MicroRetrieval Corp.

1 Kendall Sq.,
Building 300
Cambridge, MA 02139
(617) 577-1574
fax: (617) 577-9517
Circle 1166 on Inquiry Card.

Odyssey Development, Inc.

650 South Cherry St., Suite 220
Denver, CO 80222
(800) 992-4797
(303) 394-0091
fax: (303) 394-0096
Circle 1167 on Inquiry Card.

On Technology, Inc.

155 Second St.
Cambridge, MA 02141
(800) 548-8871
(617) 876-0900
fax: (617) 876-0391
Circle 1168 on Inquiry Card.

Open Text Corp.

180 King St. S., Suite 550
Waterloo, Ontario,
Canada N2J 1P8
(519) 571-7111
fax: (519) 571-9092
Circle 1169 on Inquiry Card.

SoftSolutions Technology Corp.

625 South State St.
Orem, UT 84058
(801) 226-6000
fax: (801) 224-0920
Circle 1170 on Inquiry Card.

T.I.C., Inc.

5253 Decarie Blvd., Suite 550
Montreal, Quebec,
Canada H3W 3C3
(514) 483-1294
fax: (514) 482-2041
Circle 1171 on Inquiry Card.

TexaSoft

P.O. Box 1169
Cedar Hill, TX 75104
(800) 955-8392
(214) 291-2115
fax: (214) 291-3400
Circle 1172 on Inquiry Card.

TextWare Corp.

P.O. Box 3267
Park City, UT 84060
(801) 645-9600
fax: (801) 645-9610
Circle 1173 on Inquiry Card.

TMS, Inc.

110 West Third St.
P.O. Box 1358
Stillwater, OK 74076
(405) 377-0880
fax: (405) 372-9288
Circle 1174 on Inquiry Card.

Verity, Inc.

1550 Plymouth St.
Mountain View, CA 94043
(415) 960-7600
fax: (415) 960-7698
Circle 1175 on Inquiry Card.

Virginia Systems, Inc.

5509 West Bay Court
Midlothian, VA 23112
(804) 739-3200
fax: (804) 739-8376
Circle 1176 on Inquiry Card.

ZyLab Corp.

100 Lexington Dr.
Buffalo Grove, IL 60089
(800) 544-6339
(708) 459-8000
fax: (708) 459-8054
Circle 1177 on Inquiry Card.

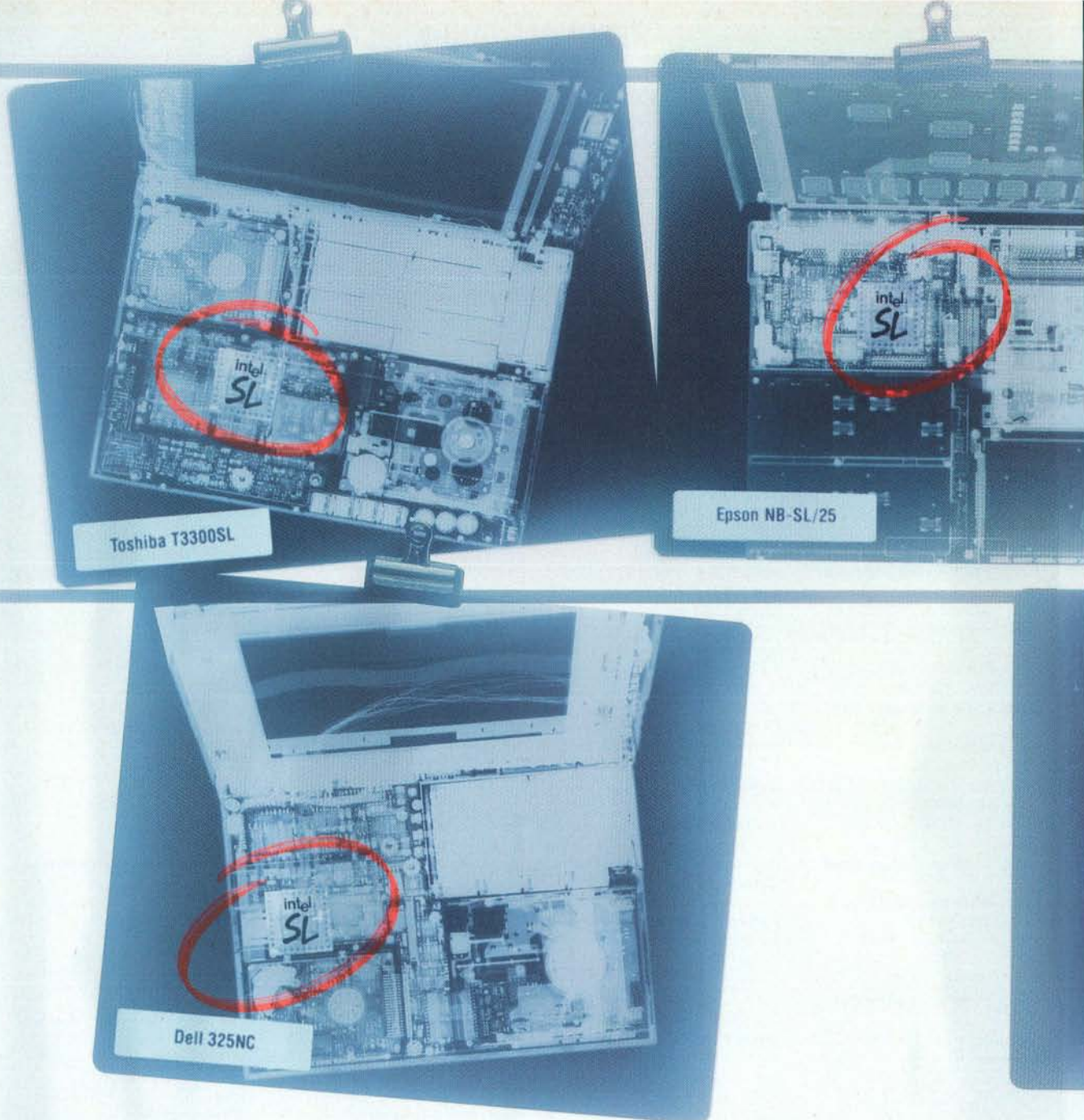

Look what's at the heart



Take a closer look at some of the best notebook computers and it's easy to see why the prognosis is so good—they each have an Intel SL microprocessor.

The Intel SL gives each of these unique notebooks a leg up, because it was designed specifically for the stop-and-go world of mobile computing.

For example, the Intel SL has an instant on/off feature

that eliminates long boot-up and shut-down sequences. If

Battery Life*



Average 386 SX
4.8 hours



Intel 386™ SL
8.2 hours

you're interrupted, the Intel SL holds your place and puts your entire system into suspended animation, using virtually no

©1992 Intel Corporation. The Intel Inside logo, Intel 386 and the SL logo are trademarks of Intel Corporation. Intel SL microprocessors in this ad are larger than actual size. *PC World Report, February 1992.

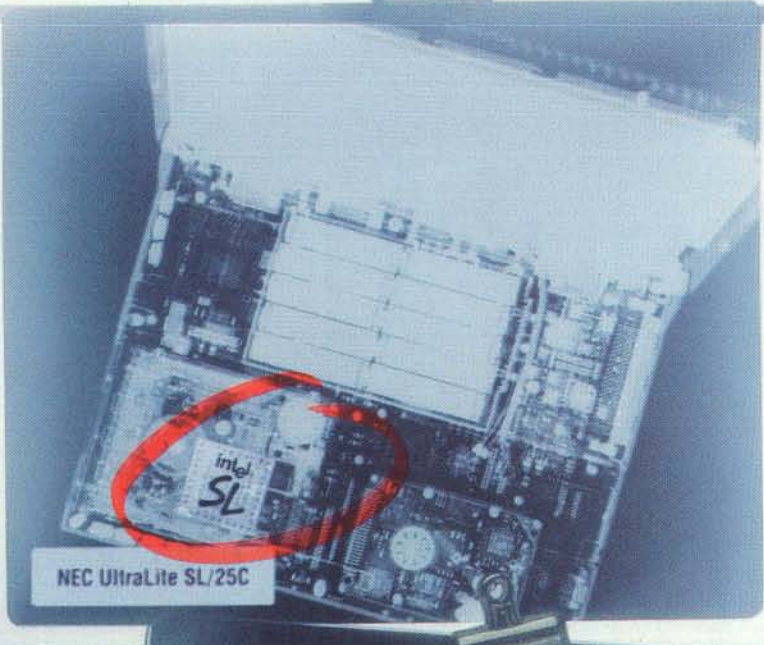

NEC UltraLite SL/25C

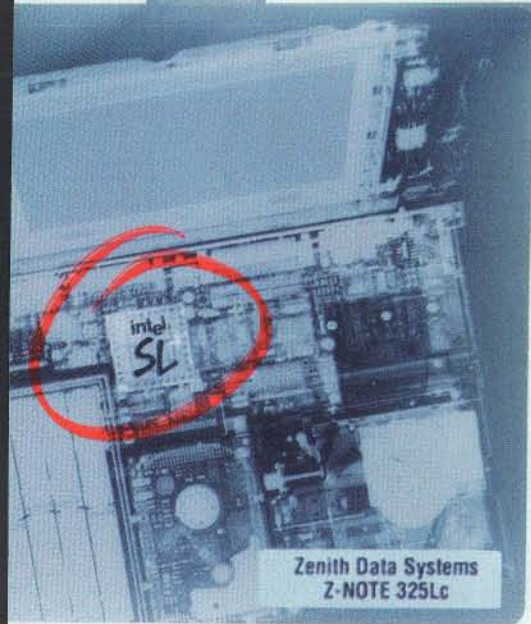

Zenith Data Systems
Z-NOTE 325Lc



Compaq LTE Lite/25

of all the best notebooks.

power and significantly extending precious battery life.

The Intel SL is a more highly-integrated micro-processor, which means lighter, more feature-rich notebooks that come in speeds up to 25 MHz. No wonder major manufacturers are prescribing the Intel386™ SL microprocessor as a cure for traveling hassles.

Call 1-800-228-4549 to receive more information and a complete list of Intel SL-based notebooks.

Then watch for notebooks with the Intel SL. Because nothing else is worth looking into.

intel®
The Computer Inside.™

SEARCHING FOR COMMON THREADS

Good text managers do more than search and retrieve—they bring organization to chaos

**RAYMOND GA CÔTÉ
AND STANFORD DIEHL**

Imagine opening a dictionary to look up a word and realizing that the entries were in no particular order. Many companies face a similar problem with corporate data. A wealth of electronic information may be there to help you do your job better, but all too often, it's in a hopeless jumble spread out over hundreds of files and directories on a LAN. You might not take advantage of a rich data resource simply because you have no efficient way of accessing it.

This month, the BYTE Lab looks at 10 software tools that can organize your textual data and help you find it quickly. We tested askSam from askSam Systems, Concordance from Dataflight Software, Folio Views from Folio, ideaList from Blackwell Scientific Publications, Isys from Odyssey Development, Magellan from Lotus Development, On Location from On Technology, re:Search from MicroRetrieval, Sonar Professional for Windows from Virginia Systems Software Services, and ZyIndex for Windows from ZyLab. All these programs organize large amounts of textual data and deliver a mechanism for finding the information you need. For stand-alone computers and especially for networked systems, these tools can be indispensable. With them, you can impose order on chaos.

The Three Approaches

There are three basic strategies for taking control of textual data. Isys, Magellan, On Location, Sonar, and ZyIndex are *file-indexing* packages. They build a search index of selected files, leaving original files in place and storing only pointers to these files in the index. These applications extract information from files that are widely spread over a network or a hard drive. They are most useful when extracting information from relatively disorganized files that may change frequently, such as the day-to-day memos, letters, and reports on a typical hard drive.

Folio Views and re:Search draw entire files into one organized structure for archival storage or for distribution; we'll call this class of packages *text libraries*.



■ WHAT TEXT MANAGEMENT PACKAGES DO

Working in several different ways, these 10 packages organize text files by content, allowing rapid retrieval of information.

■ LIKES

The best packages offer extremely powerful search and retrieval features. Folio Views and Sonar Professional are outstanding in this regard. Isys and ZyIndex combine solid search capability with an easily mastered interface.

■ DISLIKES

Text libraries and free-form databases are difficult to learn and use. Indexes often require a vast amount of space; in particular, Sonar Professional's index can be larger than the text it represents.

■ RECOMMENDATIONS

For managing dynamic, rapidly changing data, Isys and ZyIndex are both excellent solutions. Folio Views is the best at handling more static, archival information. Finally, askSam is a great general-purpose organizational tool.

Text libraries are best suited for extracting information from fairly static data files. Since your data has ceased to move around, these programs provide a much higher level of control of the information presentation. These products also provide inexpensive reader programs that you can distribute with your data—in short, they can help to publish your information.

With text libraries, you can view your data much as you might view a hard-copy book. With an outline view, you can move to a section that interests you or browse through the data a section at a time. Similar topics and subjects can be grouped together and filed under an organizational heading. Although these applications can accept free-form data, they are most useful when text is fairly well structured. These booklike interfaces can automatically provide indexes and tables of contents.

Finally, askSam, Concordance, and ideaList are examples of *free-form database managers*, hybrids between traditional database managers and text libraries. Free-form databases let you gather disparate data into a single structure. You have a great deal of freedom over the

TEXT MANAGEMENT PACKAGES: FEATURES SUMMARY

Although three classes of text management tools are represented here, similar search and indexing capabilities make each type of text manager suitable to a variety of tasks. (● = yes; ○ = no.)

	FILE-INDEXING PACKAGES					TEXT LIBRARIES	
	Isys 2.0	Magellan 2.0	On Location 2.0	Sonar Professional 1.0	ZyIndex 4.02	Folio Views 2.1	re:Search 2.12
Operating-system support¹	DOS	DOS	Mac	Windows, Mac	Windows, DOS, Unix	DOS	DOS
Price²	\$395	\$99	\$130	\$795	\$395	\$695	\$795
Searching							
User-defined concept searches	○	●	○	●	●	○	○
Nested (progressive) searches	●	○	○	●	●	●	●
Fuzzy searches (word roots)	●	●	●	●	●	○	●
Field or block searches	○	○	○	●	●	●	●
Vocabulary list (browse index)	○	○	○	○	○	○	○
Phonetic searches	○	○	○	●	○	○	○
Thesaurus or synonym searching	●	○	○	●	●	○	○
Search multiple databases or indexes	○	○	●	●	○	●	○
Save query	●	●	●	●	●	●	●
Search result sorting	●	●	●	●	●	○	●
Proximity searching							
Within number of words	●	○	○	●	●	●	●
Within sentence	○	○	○	○	●	○	○
Within paragraph	●	○	○	○	●	○	○
Order-dependent	●	○	○	●	●	○	○
Links							
Interdocument links	○	○	○	○	○	●	○
Search on selected word in document	●	●	●	●	●	●	●
Bookmarks	○	○	○	○	○	●	○
Attach notes to text	○	○	○	●	○	●	●
Generate table of contents based on text	○	○	○	●	○	●	○
Indexing							
Configure character properties	●	○	○	●	●	○	●
User-selectable "noise word" list	●	○	○	●	●	○	●
Background indexing	○	○	●	●	●	●	○
Separate search and index modules	●	○	○	●	●	●	●
Format support³							
Word processor formats	28	24	30+ ⁴	5	11	42 ⁵	2
Graphics formats	External viewer	DRW, Lotus Pick	None	Windows Metafile	TIFF, PCX, EPS, Windows BMP	PCX or External	TIFF, PCX
Other	dBase III memos	dBase, Excel, 1-2-3, ARC, ZIP	None	None	None	None	None
Editing tools							
Built-in editor	○	○	○	○	○	●	○
Run user editor	○	○	○	○	○	○	○
Run word processor based on document type	●	●	●	○	●	○	○
Documentation							
On-line help	●	●	○	○	●	●	●
Security							
Password protection	○	○	○	○	○	●	●
Access privileges	○	○	○	○	○	●	●

¹ Tested platform listed first.

² Price is for single-user version.

³ Every package can also read ASCII text documents.

⁴ Supports Claris XTND.

⁵ These are filters supplied with the package. Folio Views operates on ASCII documents.

structure and presentation of the data. You can pull in unformatted text files or gather data into fields just as you would with a traditional database. A single database can contain both structured and unstructured data.

The free-form databases are not suited for managing files on a network, but they can provide a dynamic pool of shared

data. For instance, you could add daily releases from a news wire to a free-form database and make the information available to everyone on a network. The information does not need to have the same kind of organizational and thematic relationships that are expected by a text library.

Naturally, the lines among the three

categories blur when it comes to specific applications and installations. Although each of these products is most suited to a particular solution, all can be used to solve other problems. For example, although indexing programs are best suited for maintaining widespread, frequently changing data files, there is nothing to stop you from using them to extract in-

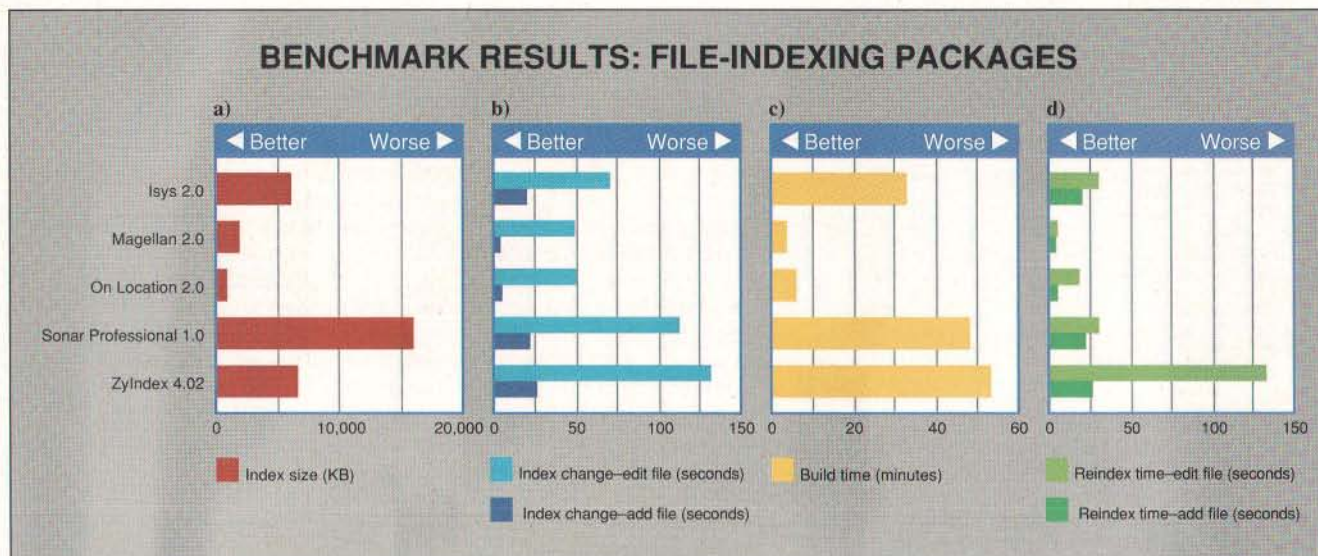

Figure 1: Benchmark results for file-indexing packages: (a) shows relative sizes of the index generated by each package, while (b) shows the change in index size when modifying and adding a file; (c) and (d) show corresponding times for each

operation. In all cases, shorter bars are better. Magellan and On Location were very quick, but these offer limited search features; of the more full-featured packages, Isys was the fastest and most efficient.

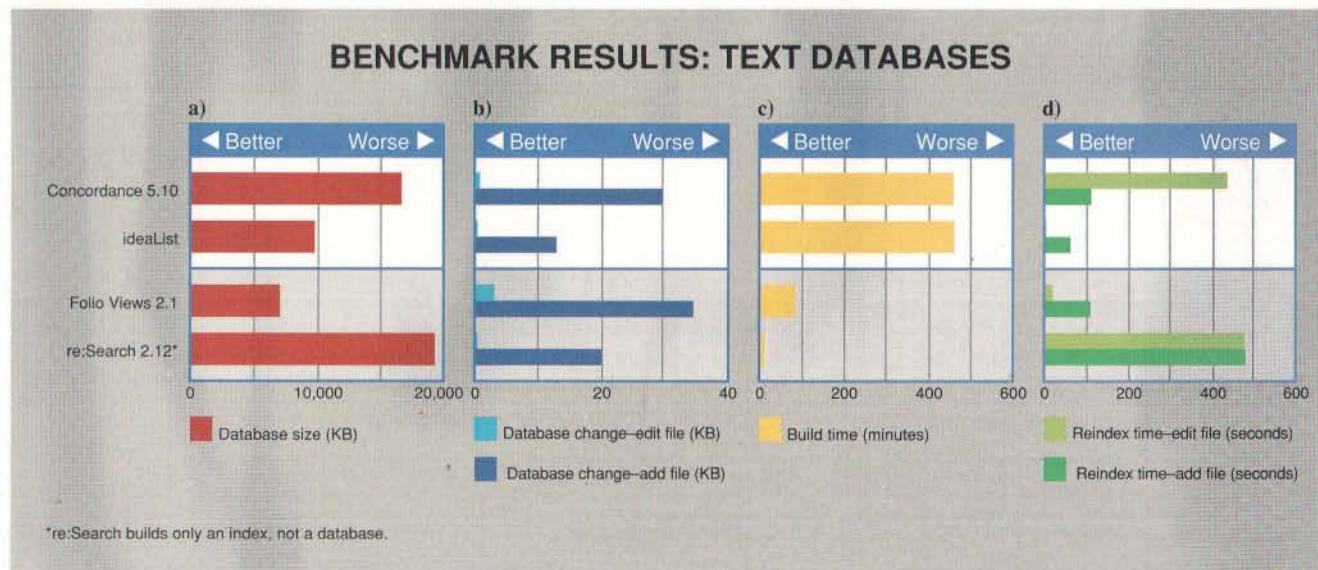

Figure 2: Benchmarks for text libraries (bottom two) and free-form database managers (top two) are similar to those we used for file-indexing packages, but these text management packages build and modify entire databases, not just indexes.

(a) and (b) show database sizes and changes in database size when modifying entries, while (c) and (d) track the times required to conduct these operations. Again, shorter bars indicate better performance.

or Frederick Douglass not Robert Jordan.”

Proximity searches add a level of flexibility. Proximity searching lets you find terms that are associated by their positions within the document. Most packages determine proximity by number of words, but some allow you to specify sentence, paragraph, and page limits. The terms *wild cards*, *conflation*, and

fuzzy searches are all used to describe the mechanisms for finding words that are near matches for the search term you've entered. These techniques must be used cautiously because they have the ability to find words in a large number of documents—often too many to be useful.

Wild-card searches assign special meaning to wild-card symbols (usually, ? to match any single character and * to

match groups of characters). With a wild-card search, searching for *post?* finds *posts* and *poste*; searching for *post** finds the same two, plus *post*, *poster*, *postage*, *postal*, *postwar*, *postscript*, and many others.

Fuzzy searching gives you the ability to find a set of words based on a common root. A fuzzy search on *postal* will also find *postage* and *postman*, because all

Introducing The First Mobile Disks.



Our new 40 to 200MB portable hard drives are on the move.

Now, wherever you go, take advantage of these great Mobile Disk features.

Snap on a hard drive in three minutes. You don't need tools. You don't have to open the computer. Simply plug Mobile Disk into any portable or PC parallel printer port and plug your printer into Mobile Disk. The software configures itself, and you're ready to go.

Small and sturdy. Mobile Disk is so durable and light, you can carry it all day and hardly notice it's there.

Carry all your data with you. You'll always have the right files, programs, and fonts at the right time. Take your files home, to your portable, or down the hall. Why carry files on floppies, when you can take your whole work environment with you?

Grows with you. Add 40, 80, 120, or 200 megabytes of data storage as you need it. Connect additional drives for maximum storage. It's quick and easy.

Easy backup. Copy critical files to Mobile Disk, or back up an internal hard drive without learning new software. Protect your data from fire or damage. Lock it up, safely.



\$399

Special Introductory Offer!

For a limited time, you can order Mobile Disk 40 for just \$399. Call today to order, or for more information:

1-800-821-2151

SYSGEN

Sysgen, Inc. 556 Gibraltar Drive, Milpitas, CA 95035.
Sysgen is a registered trademark, and Mobile Disk is a trademark of Sysgen, Inc.
\$399 price includes drive, cable, power supply, and documentation. All Sysgen products are covered by a 12 month warranty.

Circle 160 on Inquiry Card.

are based on *post*. In many cases, a fuzzy search will return better hits than a simple wild-card search.

Synonym and concept lists are two closely related capabilities that expand your ability to find information. Synonym lists are groups of terms that all mean the same thing. For example, you can create a list that contains the words *mom*, *mother*, and *ma*. A search phrase including *mom* returns documents that contain any of the terms related through the list.

Like synonym lists, concept lists group search items. But while synonym lists are single words, concept lists are entire search phrases. For example, the three search phrases "General within-words: 10 Hospital," "emergency room," and "medi* or pharma*" all relate to hospital or medical information; you could group all three of these phrases into a concept called "medical."

It can be helpful to limit the search to specific regions within a document. Free-form database packages have explicit fields (e.g., heading, body, and address), and you can limit searches to a single field. However, other packages allow you to define implicit fields, or *blocks*, by selecting words that typically delimit a region of the document.

Index Building

All these packages (except askSam—see below) build an index containing references to the words in each document you select. This index is used in all subsequent searches. Building an index takes a significant amount of time, and indexing information requires a sizable chunk of disk space. Many of the optimizations built into these packages are designed to reduce the space required for an index or the time required to build it. For a comparison of the index sizes and indexing times of a sample text base, see figures 1 and 2 on page 294.

The most important factor in determining index size is the level of complexity of the searches that must be supported. Text management packages that simply give you a filename for each hit don't need very large indexes. Products that keep track of a word's location within a file (e.g., for proximity searching) generate larger indexes.

Incremental indexing frees you from rebuilding an entire index when just a few documents change or must be added. All the packages we reviewed support incremental updates. Concurrent or background indexing is also important. Concurrent indexing allows the indexing module to update indexes while you are

using them to find information.

Not every word is included in an index. Some words, such as *the* and *and*, appear so frequently that their usefulness in locating information is very limited. Most of these packages provide an editable file containing a list of such *noise words*, which are not indexed.

All these packages can index raw ASCII text files. However, the documents you have in place may not conform to such a limited standard. Word processors such as Microsoft Word, WordPerfect, and XyWrite interleave control codes with the text. Many of these text managers can read or import documents

in various word processing formats; in some cases, they can even preserve formatting information when viewing the document or launch the appropriate word processor on demand. A few packages can also handle database, spreadsheet, and graphics formats.

To evaluate these products, we fed them a year's worth of BYTE magazine, a total of over 650 files (see the text box "Testing Text Retrievers" on page 293 for testing details). Because we looked at each package in relation to the other tools in its category, we've divided the product descriptions that follow into the three categories.

FILE-INDEXING PACKAGES

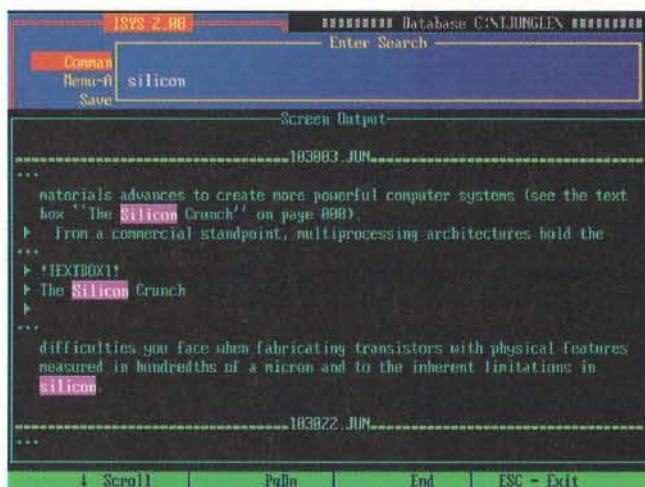

Screen 1: Isys's keyword-in-context display provides a handy summary of information.

Isys 2.0

Odysey Development's Isys is a flexible text-retrieval package for DOS systems that can be used in three ways. In addition to the interactive application, which is the form most of these packages take, Isys also includes TSR and command-line versions. The command-line version allows other programs to use Isys as a systemwide search engine, shuttling queries to Isys and reading search results using batch commands and I/O redirection. Isys sells for \$395.

You select documents for inclusion in Isys's index through an interactive dialogue that builds a rule table. The rule table documents the file path to be searched, the files to be included and excluded (by name), the document type, and several other parameters. You can enter file paths directly or select them from a graphical tree.

Isys's greatest lack is its inability to automatically determine the document

type. The other file-indexing packages we reviewed automatically determine file format based on extension. With Isys, you must explicitly link an extension with a document type.

Like all these packages, Isys wants a lot of memory. Its performance is heavily dependent on the amount of memory available. We saw a 20 percent difference in speed between running Isys within 640 KB and running it with 2 MB of expanded memory.

Although you can't search more than one index at a time, you can load a primary and an alternate index. Loading both lets you switch quickly between indexes, which is a reasonable compromise between the convenience of multiple-index searching and the speed of a single-index search.

Isys's "keyword-in-context" display (see screen 1) presents all the hits in a document with either a few words or lines of surrounding text. All matches are listed in a single, scrollable display.

continued

XTRADRIVE™

creates a second hard disk at a fraction of the cost.



Want to run Windows™ and other memory-intensive software—but short on hard disk space? Wish you could have an “extra drive” for all your applications and documents? IIT’s XTRADRIVE is the answer—the affordable, safe, easy way to instantly double your hard drive capacity!

Choose the ease of XTRADRIVE SOFTWARE or the industry-leading performance of XTRADRIVE HARDWARE.



- **XTRADRIVE Is Affordable.** It costs hundreds less than a new disk drive.
- **XTRADRIVE Is Safe.** Its patented lossless data compression technology is totally safe for your data.
- **XTRADRIVE Is Easy to Install and De-install.** Install XTRADRIVE Software with a few menu-driven commands... or snap in XTRADRIVE Hardware in moments, with no switches or jumpers needed. Either way, XTRADRIVE is the only data compression product that supports de-installation without reformatting.
- **XTRADRIVE Is Transparent.** It looks and acts exactly like a second hard disk—use the same DOS commands you’ve always used.

It’s fully compatible with your favorite applications and utilities, too... Windows, Norton, PC Tools Deluxe and more.

- **XTRADRIVE Is High Performance.** The optional XTRADRIVE Hardware module offers the highest performance data compression solution in the industry.

Whether you own a system that’s struggling to handle the storage requirements of current software... or a laptop that can’t keep pace with your storage needs... choose XTRADRIVE today for the easy, affordable solution to your hard drive storage demands!

Call IIT today at 408-727-1885 for the XTRADRIVE dealer nearest you.

 **IIT** INTEGRATED
INFORMATION
TECHNOLOGY

XTRADRIVE is a trademark of Integrated Information Technology, Inc. All other names are trademarks of their respective companies. © 1992 Integrated Information Technology, Inc. (IIT)

Circle 112 on Inquiry Card (RESELLERS: 113).

This is easy to use, and it provides lots of useful summary information in a limited space.

You can sort filenames returned by Isys on a variety of keys, from filename to number of hits to document size. Sorting search results is a useful and powerful capability that we were surprised to find missing in other packages.

Isys is an impressive, professional program. It's fast, powerful, and easy to use, and it acts exactly as you'd expect it to at every keystroke. Our benchmarks show that it generates index files of reasonable size. Of the three full-featured file-indexing packages, Isys was fastest.

Magellan 2.0

Lotus's Magellan is the Swiss Army knife of text management programs. Search and retrieval is just a part of what it can do. Magellan edits ASCII text files, performs file compression and decompression, undeletes and compares files, and more—all, as the late-night TV pitch might go, for just \$99.

Magellan is the quickest of the file-indexing packages on the PC, and it produces the smallest index files. However, it also provides the least sophisticated searching capabilities. Magellan will tell you if a file contains a word—period. If you need to look for multiple phrases within certain distances, Magellan simply is not up to the task.

Magellan understands an amazing array of file formats. Where others provide support for four or five formats, Magellan supports over 30, from dBase to Lotus 1-2-3 to XyWrite. It can even look inside .ARC and .ZIP archives and view the compressed files. Magellan may be just a quick-and-dirty search engine, but it's a wonderful way to travel around your hard drive and browse through documents.

Magellan's default setting is to use fuzzy searches, and the package has two search features that other packages lack. The first is an incremental search: Magellan shows you matching documents as you type your search criteria. It is also the only package to provide keystroke recording for automating repetitive tasks.

The results returned by a Magellan search are a little strange. Instead of simply listing the number of hits and the number of files containing hits, Magellan returns a "ranking" factor from 1 to 100 for each file. Values in the 70s and above indicate direct matches—Magellan found the exact word you typed. The more hits per file, the higher the score.

Numbers below 70 indicate matches from fuzzy searches. This takes some getting used to, and we're still not convinced that it's a more useful metric than a simple list of hits.

Lack of sophisticated search methods and odd reporting conventions make Magellan less useful than other packages when searching through virtual realms of documents for related text. However, Magellan's combination of other file management utilities with search and retrieval makes it ideal for organizing your file structure and tracking down the occasional lost file.

On Location 2.0

After spending hours forging through documentation discussing high-end, complex search algorithms, it was relaxing to turn to On Location, a breath of absolute simplicity. On Location's manual—which documents each feature clearly, if concisely—was so small that we lost it three times while writing this review.

On Location is to the Mac what Magellan is to the PC: a simple, relatively inexpensive (\$130) text-retrieval program. On Location provides very few options. You can't even choose to index a subset of the files on your disk. With On Location, it's all or nothing. This can be painful, particularly if your files represent only a small subset of those available on a large server. Luckily, On Location builds very small index files—the smallest we saw in this review.

On Location works best in small, personal environments. Indexing all files on your local drives is the best application. In this environment, it is quick, easy to use, and intuitive.

On Location installs as an INIT and a desk accessory. It locates files by name or by content. You can view files from On Location or choose to open or print them, which automatically launches the document's creator. All printing must be done through the creating application; if the application is not available, you can't print the document.

On a Quadra 900, On Location indexed our 10 MB of sample documents in just over 6 minutes. After building this primary index, On Location also runs incremental updates each time you run the program and at timed intervals.

Searches are rapid but limited. On Location provides none of the more sophisticated searches. Only simple Boolean AND and OR operations are supported. Even wild cards are missing, although

On Location will do fuzzy searches. The lack of wild-card searches is annoying.

Like Isys, On Location lets you change the order in which the search engine presents file hits. In On Location, it requires only a simple click on a title heading. For personal productivity on the Mac, On Location is a good choice.

Sonar Professional 1.0

Sonar Professional has a powerful and sophisticated search and retrieval engine, which is unfortunately buried beneath a confusing and infuriating user interface. Exploring the menu occasionally launches the application off into unintended long operations. On-line help is nonexistent; time after time, we had to dig through the manual to determine our next step.

The program comes in two versions: Sonar Professional for Windows 1.0 and Sonar Professional for Macintosh 7.0. We timed only the Windows version but had a chance to evaluate the Mac package as well. In most aspects, including the user interface, the packages are identical. The Mac version offers all the features—and suffers from all the difficulties—of the Windows version. Each package costs \$795.

Sonar Professional provides separate indexing and search modules: Sonar Setup and Sonar. Sonar Setup offers two levels of indexing, called normal setup and super setup. Normal setup adds an index file to each and every subdirectory you select. Super setup, which is optional, reorganizes these indexes for quicker lookup.

Sonar Setup can index entries in a directory or in a directory and all its subdirectories. You can't choose which files to index except at this directory-by-directory level; Sonar Setup indexes all ASCII files and other formats it recognizes. When the search program looks for a word or phrase, it scans the directory tree, looking in each directory for the subindexes built by normal setup.

At first, Sonar's normal setup scheme seemed a little bizarre. However, it does make the indexing structure somewhat more flexible. Since indexes are in the same directory as indexed files, Sonar Setup does not need to store the complete file path in each index. This lets you move the contents of a complete directory (including the subindexes) to a new location without having to rebuild an index. Unfortunately, the price of flexibility is very slow searches. Where other indexers returned results in seconds, Sonar

Finish Faster!

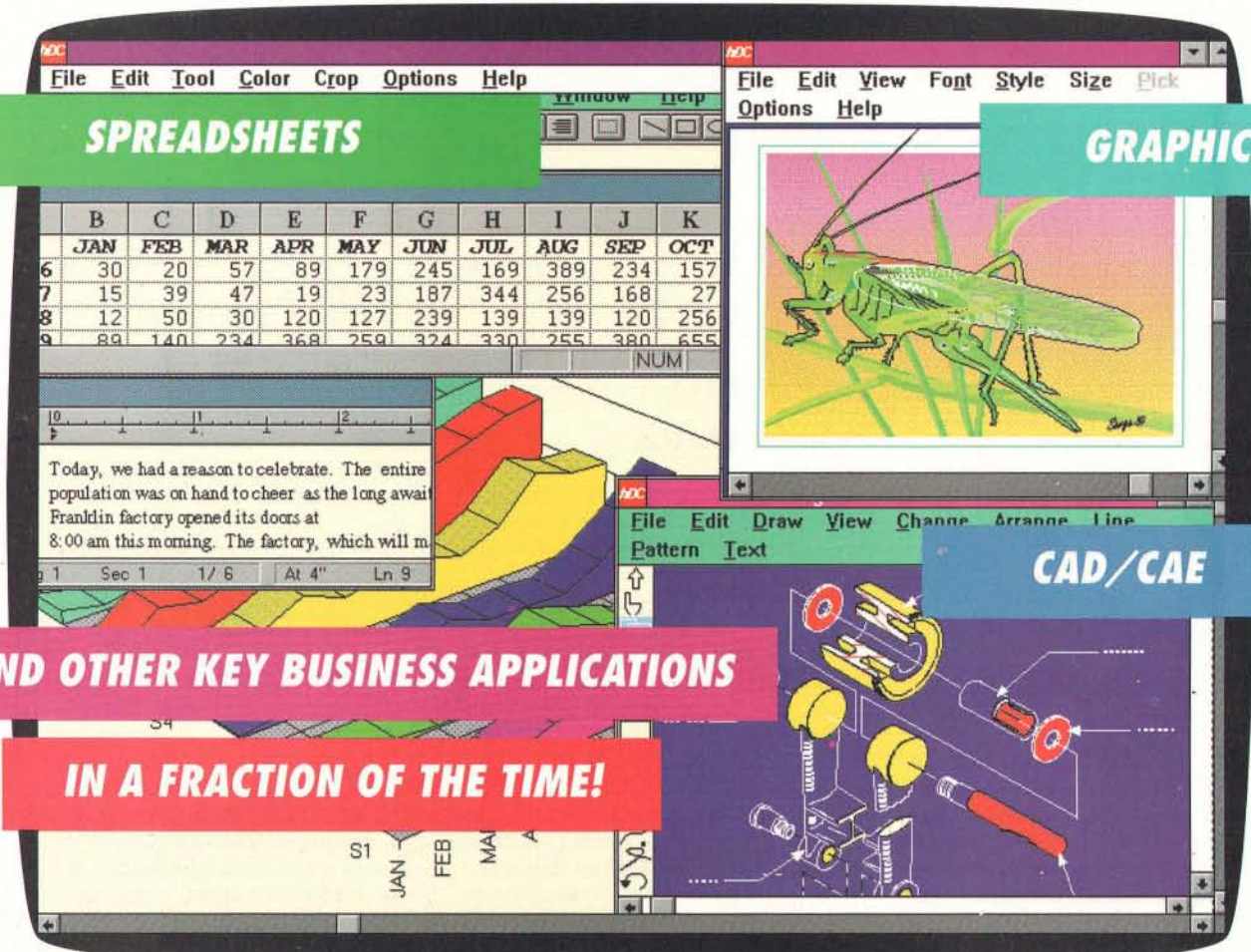

SPREADSHEETS

GRAPHICS

CAD/CAE

AND OTHER KEY BUSINESS APPLICATIONS

IN A FRACTION OF THE TIME!

with IIT's Advanced Math CoProcessor

Tough applications slowing you down? IIT's Advanced Math CoProcessor is a simple addition to your system that can instantly speed up performance by up to five times or more!

Guaranteed to be fully compatible with all 286, 386DX, or 386SX systems and software, IIT's Advanced Math CoProcessors run up to 2x faster and use 25% less power (perfect for portables!) than the leading competitor's.

And best of all, IIT warrants every Advanced Math CoProcessor for the lifetime of your system!

Put an Advanced Math CoProcessor to work for you today, and finish faster!

Call now for more information—1-800-832-0770 or 408-727-1885.



IIT INTEGRATED
INFORMATION
TECHNOLOGY

Circle 114 on Inquiry Card (RESELLERS: 115).

took over 2 minutes per search, regardless of complexity.

Sonar Setup's super setup process creates an integrated index that vastly decreases search times, placing Sonar Professional in the ballpark with the other indexing packages. That makes sense, since super setup creates an organization that more closely corresponds with that of the other programs. While normal setup arguably provides an extra level of flexibility, its slow search response renders it almost useless.

Sonar Professional's indexes are unbelievably large. Normal setup produced indexes that were larger than the original text. Super setup doubled this amount. Thus, you must have free space equal to twice the amount of text to be indexed.

Once beyond the setup and interface problems, we found Sonar Professional to be a powerful package for free-form searches. Its advanced capabilities include phonetic searching, finding associated words, and relational searching. The phonetic searches are essentially synonym searches at the syllable level. The associated word list lets you select a word and then display all other words that appear within a certain distance. The default value of 10 words provides a good balance of useful terms without listing all the words in the index.

Relational searching is a concept that takes a while to sink in—and even longer to learn how to use properly. Given a list of words and phrases, Sonar can determine if any two of them are related through a path consisting of the other phrases. Suppose you have a list of terms: Frank, Bob, Howard, Joe, President, Manager, and Financial. A relational search on Frank might produce the following: Frank > President > Joe. This tells you that the terms Frank and Joe are related, because they both appear near the term President. This is useful for seeking information relations that would otherwise be hidden.

It's an intriguing concept, but the need to define a set of terms for the linkages indicates that you know what the linkages may be and need to verify your hunch. A much more useful feature would be the ability to search through the index and determine which other words are related through a chain of limited length.

Virginia Systems Software Services has obviously worked hard on the guts of this package. Now it should work on getting the user interface up to speed. Sonar Professional has the potential to be one of the best indexers, but its frustrating interface and indexing scheme make it just too difficult to use today.

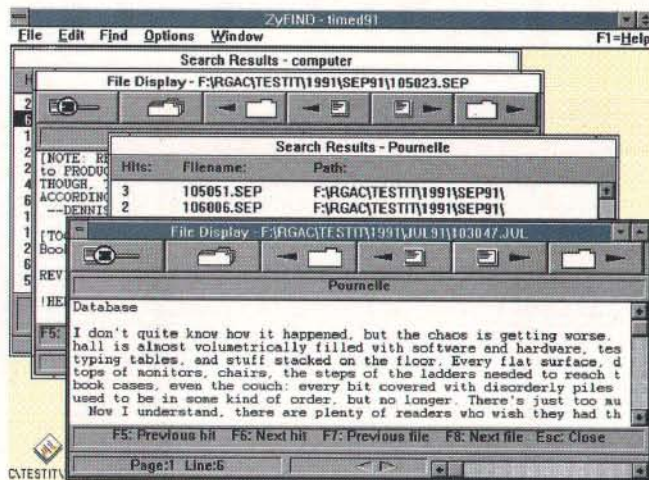

Screen 2: ZyIndex allows multiple query-results and document windows to be open at one time.

ZyIndex 4.02

In stark contrast to Sonar Professional, ZyIndex for Windows is extremely easy to use, and it conforms well to the standard Microsoft Windows interface. Although difficult to quantify, ZyIndex for Windows just feels right. ZyIndex is also available for Unix and DOS systems, but ZyIndex for Windows indexes are not interchangeable with those of the other versions.

ZyIndex for Windows consists of two programs: ZyBuild and ZyFind. These programs can run concurrently. You can choose files for indexing using standard DOS wild cards, selecting an individual directory, an entire drive, or anything in between. One of ZyBuild's most powerful features is its ability to index files in unrelated directories, whereas other packages will allow only a single directory and all its descendants. You can explicitly include or exclude files by name, ensuring, for example, that you do not index any temporary (.TMP) files.

The ZyFind portion of ZyIndex is easy to use. A logical, menu-driven query dialogue lets you build complex queries easily. An on-line thesaurus helps you search for concepts and synonyms in ad-

dition to specific terms. ZyIndex lets you keep multiple query-results windows open simultaneously (see screen 2).

One of ZyIndex's few annoying limitations is its inability to search for information once a document is in the viewer. Frequently, you'll want to find a document with a certain search phrase and then look for related terms in the document with a simple word finder. In ZyIndex, you need to page through the document manually.

ZyIndex displays the total number of files found, the total number of hits in all documents, and the number of hits in each document. ZyIndex doesn't let you sort this output by hit frequency or filename; the files appear in the order in which they were indexed. Although this is not much of a concern when only a few documents match the search criteria, it makes scanning results difficult when there are only one or two documents with large hit frequencies lost in the noise of many files with small hit frequencies.

ZyIndex has several unique searching features. You can limit searches to specific names and date ranges. The search engine handles numbers intelligently, for example, matching "3" on a search for "3.00." The quorum function rounds out ZyIndex's unique capabilities. It requires a document to contain a minimum subset of a word list. You specify a list and the minimum number of words that must be found in that list to generate a hit.

The benchmark tests show that ZyIndex is a little slower than Sonar Professional and quite a bit slower than Isys. Index files were slightly larger than those of Isys. ZyIndex provides rapid response and a clean feel, and it meshed well with our work styles. Its \$395 price tag is typical for this class of package, but its ease of use is exceptional.

ZyIndex for Windows has the right feel and is easy to use.

continued

Introducing the ALR Ranger M486 Series

When you unleash the 486™ power of the ALR Ranger, you'll be astounded by this notebook's sheer speed and portability. You may even wonder how something this powerful (yet concealable) can be legal. Still, if you're tired of notebooks that force you to compromise power for portability, and you're determined to get the most for your money, then the ALR Ranger M486 is the only notebook for you.

Featuring the processing power of an **advanced i486SX™** or **i486DX™** processor and a standard 4-MB of RAM (expandable to 16-MB), the Ranger M is actually *more* powerful than most desktop office PCs.

8.5" Diagonal Backlit Passive Matrix Color Screen Offering 640 x 480 Resolution and Up To 64 Colors



9" Diagonal Backlit LCD VGA Screen Offering 32 Shades of Gray and a Full Size Tactile Keyboard



Prices start at \$4,395



Because it factors in both charge and discharge times, ALR's advanced "Gas Gauge" is the most accurate in the industry.

Of course, all this power becomes useless if you run out of battery power. That's why the Ranger M - with its processor controlled Nickel Metal Hydride battery pack and super accurate power

monitoring software - can run up to **five hours off a single charge.**

Prices and configurations subject to change without notice. Pricing based on U.S. dollars. ALR is a registered trademark of Advanced Logic Research, Inc. Intel Inside Logo is a trademark of Intel Corporation. All other brand and product names are trademarks or registered trademarks of their respective owners. ALR does not imply any affiliation with the city of Beverly Hills or its police department. © 1992 by Advanced Logic Research, Inc.

It's So Powerful, You May Have To Register It With Your Local Authorities.

**20-MHz
i486SX
Upgradeable
Notebook
\$3,395**

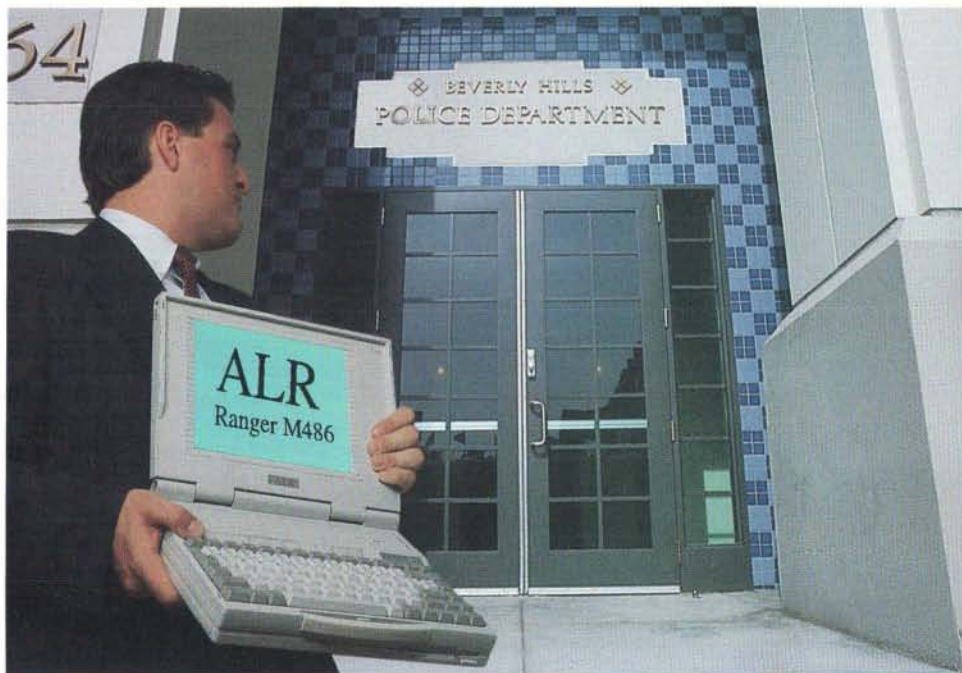

What Sets the Ranger M 486 Apart...

An advanced modular design makes it easy for you to plug in more powerful CPUs whenever your processing needs increase.

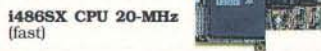

And with the Ranger's two unique internal I/O slots, you can install...

Data Compression Module
Double the size of your hard disk

FAX/Modem
9600 baud (FAX)
2400 baud (Modem)

SCSI Interface
Perfect for an external CD ROM, hard disk or tape back-up

Try finding another notebook with that much expandability! For office use, try the **ALR Ranger Station**. Just slide the Ranger M486 in, and instantly gain extra storage and three full-length ISA expansion slots.

Sure, you could pay more for other notebooks. But you'd get less. And *that* really would be a crime. For more information, call:

1-800-444-4ALR

ALR 9401 Jeronimo
Irvine, CA 92718
TEL: (714) 581-6770
FAX: (714) 581-9240

Available at these nationwide locations:

ComputerLand **Connecting Point** **ENTRE**
Business to Business. Personal to Personal. COMPUTER CENTERS

JWP BUSINESSLAND **TCBC** **ALR Power Partner Resellers**

Circle 73 on Inquiry Card (RESELLERS: 74).

TEXT LIBRARIES

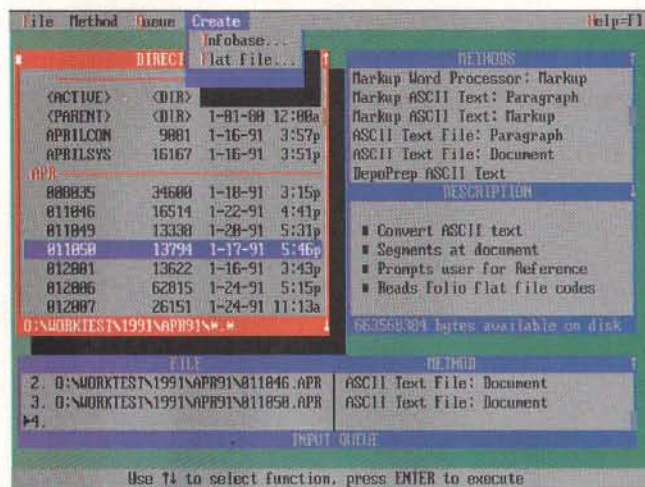

Screen 3: Folio Views has a utility for queuing up multiple files, converting them to a suitable format, and creating an infobase.

re:Search 2.12

MicroRetrieval's re:Search (\$795 for a single-user license) is a bit difficult to classify. Although it is clearly a tool for collecting and distributing a set of documents, re:Search does not combine the documents into a single structure, as Folio Views does. Even so, re:Search works better as a tool for distributing an organized set of data than it does for managing large numbers of dynamic text files on your hard drive or network.

Collections of documents are called libraries in re:Search. Each library is separated into subject areas, which in turn are divided into catalogs. Only the catalogs can contain the documents themselves. The other designations are purely organizational divisions. For our project, we created a library called BYTE 1991 and built catalogs for each month. Individual articles resided in the catalogs.

When you create a catalog heading, you specify a path to the documents making up the catalog. Once you have set up the catalog, you can load all the documents in the catalog directory or select files by extension.

Although the files are left in place and wild cards can specify a set of documents for a catalog, reindexing a catalog will not include new documents in a directory. You must perform a load operation first. Reindexing will index only the filenames already established in the catalog; it will not gather new ones. In fact, if you delete a file from the directory and try to reindex, re:Search will report an error and rather inelegantly blow you out of the program entirely.

You can embed references to PCX and TIFF files in your text files so that they can be viewed from a re:Search document, but you can't designate hypertext-style links for easy navigation across catalogs. And even though you are able to view and even attach text notes to your documents, you cannot edit within re:Search.

The best part of re:Search is its organizational structure, but this structure also

Folio Views 2.1

Unlike file-indexing packages, which leave search documents in place in your directory structure, Folio Views gathers your documents into a single large compendium of files. It indexes these and also adds the index into the library. While this requires more overhead than a simple file indexer, it also makes Folio Views ideal for archiving and distributing information. Folio Views sells for \$695 in a single-user version.

Once you've built a Folio Views text library (an *infobase*, in Folio parlance), you can search with an integrated set of tools and a very functional interface. Getting to that point is the problem. The tools for building and configuring an infobase are not smoothly integrated, nor are they easy to use individually. And the documentation only makes matters worse.

To be fair, it was not difficult to simply pull together a set of unformatted files and create a usable infobase. We had to queue up each file one at a time, since wild cards are not accepted, but Folio Views loaded these into a single structure and created an index automatically.

As you enter a search query, a window displays the index and performs an interactive lookup. By striking the Tab key, you can cycle to the beginning of each file in the infobase. And you can collapse the files to show only the first line or the first few lines, in effect producing a simple outline of the infobase structure.

You can add structure to an infobase as you work with it. You can easily join files (i.e., "folios") into groups, set up hypertext links to other folios or other info-

bases, and even establish headings and subheadings as you go. The integrated editor lets you edit and organize an active infobase. Unstructured infobases proved surprisingly flexible and useful. In fact, we ended up drawing our BYTE files into an infobase and then creating organizational groups after the infobase had been built. We then tacked on a separate file with embedded links to create a table of contents.

To take advantage of the real power of Folio Views, you need to start with a set of structured text files. The structure does not have to follow a specific format, but Folio Views needs to know which elements are headings, which are the beginnings of sections, and so on. Folio Views ships with an impressive range of word processor filters to convert common formats into Folio codes. Folio Views' PREP utility (see screen 3) helps to automate the process.

The trick is getting along without useful documentation. Instead of moving through the construction of a sample project, the Author's Guide tries to explain many different ways of doing the same things. This is confusing, especially since some of the methods are cryptic.

Folio Views displayed excellent performance and efficiency. Not only was the original indexing fast, but incremental indexing is done on the fly, with a negligible performance hit. The files and indexes are combined and compressed so that the final size of the infobase (even with the index included) is smaller than the total size of all the original files.

Once you understand how to use the construction tools and how to format text files for input, Folio Views delivers impressive results. You can distribute info-

TEXT MANAGEMENT

imposes some restrictions. You have to specify a single catalog to perform a search, so you cannot search across an entire library. You can also reindex only one catalog at a time. This ends up im-

posing a serious performance hit. Compared to the on-the-fly reindexing offered by Folio Views, re:Search's updating mechanisms are slow and far too manual.

FREE-FORM DATABASE MANAGERS

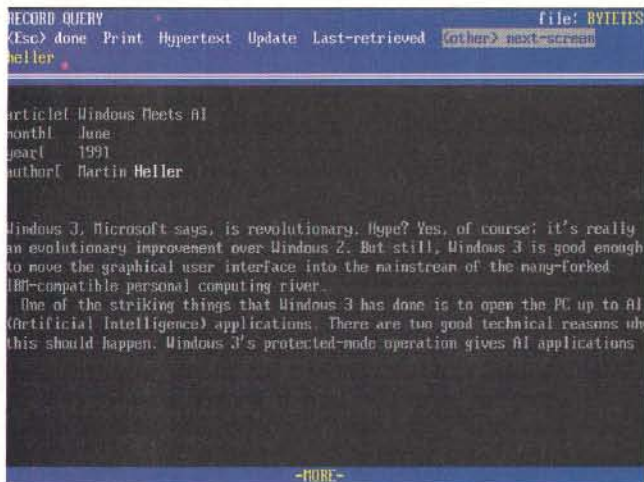

Screen 4: With askSam, you can drop a field-definition template over existing data, quickly loading free-form text into structured fields.

askSam 5.01

This package is like that junk drawer most of us have at home. You can throw just about any type of information, structured or unstructured, into an askSam database and be able to find it later when you need it. At \$395 for the single-user edition, askSam deserves a close look.

With askSam, you can easily store a group of unformatted text files in an unstructured database. Even without a defined structure, you can perform complex queries, including wild-card designators, Boolean expressions, and proximity searches. You can browse through your data, jumping to each occurrence of a search hit, or you can create a subset of records by tagging them. The askSam hypertext feature simply feeds a word from within a record to the search engine.

Also, askSam lets you define fields to better structure your data. Fields can be defined up front, or you can create templates for field definitions. You can pull up a record and then place the field template on top of it. In this manner, you can take a record that contains header information, and by applying your template to the record, you are able to turn the header information into fielded data (see screen 4).

The askSam package combines the searching features of a text indexer with

some of the more powerful capabilities of a database manager. You can sort on fields or on words in a free-text document and send the result to a disk file. You also are given some strong reporting features for formatting your output. This includes such things as headings, footers, and tallies.

As a database manager, askSam has relational capabilities. You can search one file and then scan a second file, depending on the results of the primary search. You might have a database of names and a second database of memos. You could produce a list of the names in your primary database along with a listing of all the memos you have sent to each name.

A number of features make askSam an interesting product. Although it does not create a full-text index, it scans text with surprising efficiency. We had no problems searching through our BYTE articles without the use of an index. However, as the database grows, searches slow down. The package can index on data fields; and it automatically searches through any newly added, unindexed material after the indexed search is complete.

Perhaps because of its flexibility or perhaps because of its uniqueness, this program is somewhat difficult to learn. However, if you are willing to invest some time and energy, askSam can give you control of your textual data.

continued

Clean. Simple. Intuitive.

InnerView™ Text and Image Retrieval Software

for Windows and Macintosh

It's easy to get lost in myriads of paper documentation—but you'll never again get lost when you're using InnerView featuring:

- Full-text search
- Fielded search
- Extensive hypertext
- Superior image display

Whether published on CD-ROM or over a network, it's cost effective. Electronic information saves search time for the user and dollars for the publisher. InnerView is great for users—and great for the bottom line.

If you're still publishing any kind of technical documentation or reference material on paper, it's time to look into InnerView. Clean. Simple. Intuitive. And cost effective. It's all you'll ever need!

Call for a demonstration disk!

TMS, Inc.

tools for the information industry

HEADQUARTERS

P.O. Box 1358

Stillwater, OK 74076

Phone: 405/377-0880 Fax: 405/372-0452

WEST COAST

800 El Camino Real West, Suite 180

Mountain View, CA 94040

Phone: 415/903-2252 Fax: 415/903-2253

Concordance 5.10

Dataflight's Concordance employs a standard database structure to store and index large amounts of textual data. It includes a "paragraph" field type, which can store free-text documents of up to 64 KB. Documents larger than this limit are divided into multiple records. You can define fixed fields for traditional fixed-length data and reserve the paragraph fields for explanations or free-form notes, or you can load text files into the paragraph fields and load the associated fixed fields with identifying information, such as article name, author, and issue number. You can then search the entire database or only the fixed fields using a powerful query language.

You create a Concordance database by first defining field names and types. You must define a paragraph field if you want to import large free-text files. Once the structure is defined, you can use wild cards to import multiple documents. You can specify each document as a single record, or you can provide delimiters to break up a large file into multiple records. You can then place identifying in-

formation into the other data fields.

It's fairly easy to get data in and out of Concordance, but it's not easy to retain the document format. When loaded, our (DOS) documents had carriage returns/linefeeds at the ends of paragraphs. When exporting documents, we could specify only one character to designate paragraph breaks, so the exported documents did not have the carriage return/linefeed pair at the ends of paragraphs.

A search query returns a subset of found records. This becomes, in effect, the acting database, available for further narrowing of the data. You return to a view of the entire database by searching for all records with a wild-card entry. Queries can be saved and recalled easily. You can also sort the entire database or a subset. You simply tell Concordance which fields you want to sort on.

From Concordance's document mode, you can edit files, perform search-and-replace operations, and import additional text into the database. You can also apply overlay files to a document to insert delimited data into predefined fields or to serve as a text template. Concordance does not allow hypertext-style linking

from within a document.

The Concordance programming language supports a wide range of file management, query-control, text-manipulation, screen-presentation, and data-handling functions. However, we found the basic operation of the package somewhat limited. Especially disturbing was the length of time it took to create indexes. Although the manual suggests some methods (e.g., freeing up memory and adding disk caches) for improving this performance, we have to question a product that takes over 7 hours to index 10 MB worth of data on a 50-MHz 486.

Concordance offers a strong structural approach for cataloging and presenting large amounts of text and data, but given its lackluster performance and steep price (\$995), we can't recommend it.

IdeaList

Although ideaList acts in many ways like a database, it does not insist on a rigid structure. You can set up fields and use ideaList like a traditional database, or you can simply import text files

DATA COMPRESSION LIBRARIES™

PKWARE's® Data Compression Libraries™ allow software developers to add data compression technology to software applications. The application program controls all the input and output of data allowing data to be compressed or extracted to or from any device or area of memory.

- All Purpose Data Compression Algorithm Compresses Ascii or Binary Data Quickly with similar compression achieved by the popular PKZIP software, however the format used by the compression routine is completely generic and not specific to the PKZIP file format.
- Application Controlled I/O and memory allocation for extreme flexibility.
- Adjustable Dictionary Size allows software to be fine tuned for Maximum Size or Speed.
- Approximately 35K memory needed for Compression, 12K memory needed for Extraction.
- Compatible with most popular Languages: C, C+ +, Pascal, Assembly, Basic, Clipper, Etc.
- Works with any 80x86 family CPU in real or protected mode. \$295.00
- No runtime royalties.

RUNNING OUT OF EXPENSIVE DISK SPACE?

PKZIP can help! **PKZIP** compresses your files to free up disk space and reduce modem transfer time. You can compress a single file or entire directory structures with a single command. Compressed files can be quickly returned to their normal size with **PKUNZIP**.

Software developers can reduce the number of diskettes needed to distribute their product by using **PKZIP**. Call for Distribution License information.

The included **PKZIP** utility lets you store compressed files as a single self-extracting .EXE files that automatically uncompresses when run. Only \$47.00



9025 N. Deerwood Dr.
Brown Deer, WI 53223
(414) 354-8699
Fax (414) 354-8559

BY692

as records. While flexible, this approach is not designed to manage dynamic files.

This package rarely follows a traditional approach to any task. To define the fields in your database, you create entries in a definition file. You design a new record type by prefacing the name of the record with a colon. The record name is followed by the names and types of the fields within that record.

To import records, you design a file to tell ideaList how to format the incoming ASCII data. The program can handle delimited files, dBase files, or records with tagged fields. You can also import a group of text files with a wild-card designation, and each file will be brought in as a separate record.

When you enter a search query, ideaList creates a hit list of all the records containing the requested term. The active database of records is then narrowed down to the subset of records matching the query. You then further narrow the search by simply entering another query. In addition, you can tag the records you want included in the hit list or drop records from the list one at a time.

Simple macros are supported in ideaList. You list all your macro definitions in a single text file. The macro facility lets you record operations and save them to the definition file. You can distribute a run-time module with your finished databases so others can access the data.

Building the database is a time-consuming process, as the benchmarks show, but performance on edits and updates is outstanding. Updating its index on the fly, ideaList performs simple updates to edited records almost instantly.

This package offers a simple means for bringing together free-form text into a searchable database structure, but it lacks the programming power of askSam. Although the price (\$225) is alluring, ideaList has some structural weaknesses. For example, it cannot handle text files larger than 64 KB. Files larger than the limit are simply left out of the database. Creating I/O formats, while flexible, can be complicated and requires a certain amount of computer proficiency. The program lacks polish and some of the more advanced interface features expected of today's software.

Top Management

If you are planning to impose some organization on what is now a sea of scattered text files, you have several good choices. From among the file-indexing packages, either ZyIndex or Isys will serve you in good stead; we have a hard time choosing between the two. Both offer solid search capabilities and innovative interfaces, but we found Isys a little more to our taste. Of course, ZyIndex is the only option if you want to run under Windows.

Folio Views is our choice for building text libraries. Though somewhat complex, it builds the most accessible and powerful structure for holding large amounts of relatively stable information.

If you need to perform sophisticated sorting and data manipulation, askSam is the best of the free-text databases. It effectively applies database functionality to textual data and handles structured or unstructured data with ease. ■

Raymond GA Côté and Stanford Diehl are testing editors for the BYTE Lab. You can contact them on BIX as "rgacote" and "sdiehl," respectively.

COMPANY INFORMATION

askSam Systems

(askSam 5.01)
P.O. Box 1428
Perry, FL 32347
(800) 800-1997
(904) 584-6590
fax: (904) 584-7481

Circle 1301 on Inquiry Card.

Blackwell Scientific Publications

(ideaList)
3 Cambridge Center
Cambridge, MA 02142
(800) 695-3364
fax: (800) 695-3364

Circle 1302 on Inquiry Card.

Dataflight Software

(Concordance 5.10)
10573 West Pico Blvd., Suite 68
Los Angeles, CA 90064
(800) 421-8398
(310) 398-2787
fax: (310) 398-0194

Circle 1303 on Inquiry Card.

Folio Corp.

(Folio Views 2.1)
2155 North Freedom Blvd., Suite 150
Provo, UT 84604
(800) 543-6546
(801) 375-3700
fax: (801) 374-5753

Circle 1304 on Inquiry Card.

Lotus Development Corp.

(Magellan 2.0)
55 Cambridge Pkwy.
Cambridge, MA 02142
(617) 577-8500
fax: (617) 693-1779

Circle 1305 on Inquiry Card.

MicroRetrieval Corp.

(re:Search 2.12)
1 Kendall Sq., Building 300
Cambridge, MA 02139
(617) 577-1574
fax: (617) 577-9517

Circle 1306 on Inquiry Card.

Odyssey Development

(Isys 2.0)
650 South Cherry St., Suite 220
Denver, CO 80222
(303) 394-0091
fax: (303) 394-0096

Circle 1307 on Inquiry Card.

On Technology, Inc.

(On Location 2.0)
155 Second St.
Cambridge, MA 02141
(617) 876-0900
fax: (617) 876-0391

Circle 1308 on Inquiry Card.

Virginia Systems Software Services, Inc.

(Sonar Professional 1.0)
5509 West Bay Court
Midlothian, VA 23112
(804) 739-3200
fax: (804) 739-8376

Circle 1309 on Inquiry Card.

ZyLab

(ZyIndex 4.02)
100 Lexington Dr.
Buffalo Grove, IL 60089
(708) 459-8000
fax: (708) 459-8054

Circle 1310 on Inquiry Card.

Writing in Style

The BYTE Lab tests the top WYSIWYG word processors for Windows and the Mac

**D. BARKER, DAVID L. EDWARDS,
AND STAN WSZOLA**

printer. You need a product that does word styling as well as word processing.

The nine WYSIWYG word stylers reviewed here won't transform dull prose into Pulitzer prize material, but they can make it easier to turn out polished-looking documents. Besides the ability to mix type styles and page formats—and closely approximate final output on-screen—the packages we evaluate have two other points in common: All are Windows- or Mac-based programs and all carry list prices of \$500 or less. Due to space constraints, we couldn't include two notable products in this report. Lotus Write is a trimmed-down, less expensive version of Ami Pro. And we reviewed WordPerfect for Windows in our March issue. For a comparison of how these products stack up on a feature-by-feature basis, see the table on page 309.

The Benefits of WYSIWYG

With word processors that lack WYSIWYG capability, the best way to get a sense of how your final document will look is through a program's print preview. This feature generally works well for such things as ensuring that headings are centered and checking that you haven't left the last line of text standing all alone on a page. But if you want to know now how your printed manuscript will look, you should buy a WYSIWYG word processor.

When appearance matters, a WYSIWYG program offers the most efficient means of preparing your material. Today's best word processors not only can display different fonts on the screen, but they can flow text into multiple columns, mix different column widths on the same page, and import and manipulate graphics. They don't have the sophisticated typographical controls of advanced DTP (desktop publishing) programs—nor do they offer as complete control over placement of the elements on a page—but WYSIWYG word processors do let you produce a simple three-column newsletter or the like, without going to the expense of buying and mastering an intricate DTP package.

Although these packages are not full-fledged publishing software, many of them use the same techniques and metaphors as DTP programs. Some use a frame-based approach for setting up a document.

Frames are adjustable rectangles into which you place text and graphics. The procedure varies, but the concept is the same: You draw the frame where you want it on the page, then pour the text or image into that block.

Some of the programs save you the trouble of setting up a page by providing a template, a predefined layout format. All the packages reviewed let you design style sheets, which are catalogs of formatting commands that automatically set the look of the text. If, for example, you publish a newsletter that always has boxed information you want to run in smaller type than the rest of the publication, you could set up one style sheet for your main text and another for the text that goes in the box. Choosing

Cranking out documents with an old-style, text-based editor isn't quite as difficult as working blindfolded, but it's tough to produce sharp-looking pages with a package that lacks graphical orientation. Although non-WYSIWYG word processors can produce a handsome final product, you won't see what you'll get until you get it. That's fine for people who like surprises. But if you work in a busy environment, where the deadline is always yesterday, you need an editor that gives you a clear idea of how your document will look before it comes off the

the name of the appropriate style sheet formats the text to the desired specification. Style sheets greatly simplify the process of formatting text.

Put to the Test

To see if this group of graphical word processors could produce the kinds of documents that once were the province of DTP software, we used Aldus's PageMaker to devise a test document resembling a typical newsletter. It has a three-column format and a full-width banner headline and includes multiple type styles and sizes, imported graphics, tables, rules, and page numbers. Then we tried to duplicate the newsletter using each of the word processors.

Our aim wasn't to judge the packages on the basis of their page-layout functions. Rather the newsletter model allowed us to see how well the programs fare when their graphical capabilities are pushed—when they're asked to juggle multiple columns, type sizes, fonts, design elements, several pictures, and check the spelling while they're at it. We reasoned that, if a word processor can handle basic DTP chores, it can handle any word processing chore you might toss its way.

In addition, we evaluated each package's WYSIWYG quotient: Is what you see on the screen really what you get on the printed page? For most packages we found that it is. Because the type displayed on-screen doesn't exactly match the type that comes out of the printer, however, minor differences sometimes crop up.

WYSIWYG word processors can be slow on the wrong hardware. We ran the Windows packages on 386es and 486es, and the performance was fine. On a 386SX with less than 2 MB of RAM, however, performance can feel sluggish, particularly when a page contains graphical elements. We tested the Macintosh programs on an SE/30, an SE, a IIx, and a Mac II with a Radius Rocket. For the most part, program execution felt snappy. On a Quadra, the packages sang.

WINDOWS PROGRAMS

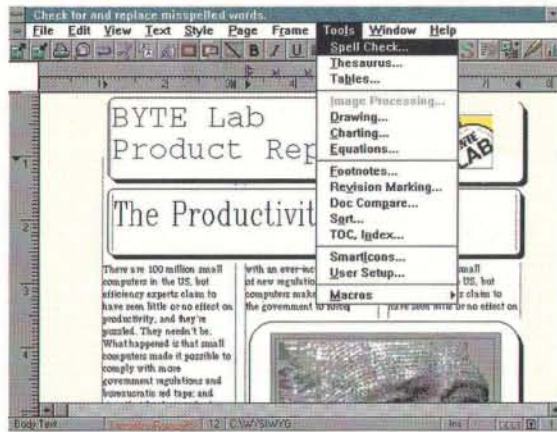

AMI PRO 2.0

Ami Pro is a blue-blooded Windows application. Its not-too-distant ancestor, Ami, was the first word processor designed for the Windows environment, which means it was developed from the ground up to be a graphical editing program. For Ami Pro, WYSIWYG capability comes naturally.

It's clear from the first time you set eyes on the program that its developers love icons. The toolbar just below the menu bar at the top of the screen is packed with graphic representations of the most common editing and formatting functions. While working with these icons can save you time and mouse-clicks, as with Word for Windows, it takes practice to remember what each one does. Instead of memorizing each function, you may prefer to create customized icons by redefining the operation of existing icons or designing new ones using any bit-mapped Windows file. You can't, however, change the menu command bar except by adding a command with the package's macro programming language.

As a text editor, Ami Pro is superb. Memory permitting, you can open a maximum of nine windows, each containing a different file. In addition, you can open two windows to display the same file, although you can edit in only one window at a time. Unlike Word for Windows, Ami Pro uses Windows' Multiple Document Interface, so you may reduce several documents to icons, which makes it easier to move between documents.

Ami Pro uses style sheets to define a

document. You can work with the default style sheets, edit the sample sheet included in the package, or create your own. Like many of its competitors, Ami Pro takes a frame-based approach to adding graphics, special text, and tables to a document. To add these sorts of elements to a document, you set aside defined regions called frames and move information into them. When you move and resize a frame, text outside the frame flows, or wraps, around it.

Creating the test newsletter with Ami Pro is relatively easy. You can start with a predefined style sheet or modify the default style sheet. After importing the sample text file, you pull down the Page menu, click on the Page Layout option, and enter the number 3 to indicate how many columns you want. The text then immediately rearranges itself into three snaking columns.

Working with frames gives you a good deal of flexibility in setting up your page. Ami frames, which can hold text and graphics, are easy to work with. To assemble the test document, you click on the Frame menu item, select the Create Frames option, and insert one frame each for the newsletter's headline, subtitle, and graphic element. You can insert text for the headline and subtitle in Layout mode and experiment to get exactly the right font and size. If you want to move a frame, you simply click on it and drag it. Inserting a graphic element into a frame is just as easy; Ami translates the file format and automatically resizes the graphic to fit the existing frame.

When compared against Word, Ami



SUMMARY

AMI PRO 2.0

PROS Toolbar allows for fast formatting; powerful macro language; flexible frames for page design; good handling of graphics; integrated E-mail

CONS Cryptic icons; macro developer's kit not included; lacks drag-and-drop operations

BYTE ACTION SUMMARY

■ WHAT WYSIWYG WORD PROCESSORS DO

Let you type and edit text comprising varying type styles and sizes, combine text and graphics on a page, and see an on-screen display that closely resembles the printed document

■ LIKES

Ability to work with different fonts and type sizes, ability to mix text and images, graphical controls, ease of learning

■ DISLIKES

Snafus when manipulating graphics, memory and hardware demands, sluggishness on lower-end PCs

■ RECOMMENDATIONS

Microsoft Word and Ami Pro are the best WYSIWYG word processors under Windows. They're similar in capability, but Word has drag-and-drop editing; Ami Pro handles graphics better and has a good macro language. On the Mac, Word 5.0 is the best for most typical word processing jobs; it's fast and it's intuitive. WordPerfect is equally capable, but is better suited for complex documents, and stands alone in its use of QuickTime movies.

has one shortcoming: It lacks the ability to move a block of text within a document by dragging and dropping it with the mouse. With Ami, you must define the block of text and use your keyboard's cursor keys to move it to a different location, a minor inconvenience.

One of Ami's greatest strengths is its macro programming language. It lets you combine a rich variety of programming statements with the built-in macro functions and the standard Ami Pro functions to create very powerful word processing tools. The macro language lets you add entries to the command menu bar, as well as create pop-up dialog boxes, keyboard shortcut commands, and your own pull-down menus. You can apply these alterations to the entire program or limit them to a particular template. You can even create applications for use from within Ami; sample macros provided with the package include an address book and an area code directory.

To generate a new macro, you simply click on the Record Macro function. Any macro may be edited and played back to test its functions. Lotus also sells a Macro Developers Kit (\$9.95) that includes a substantial manual and a floppy disk containing a large collection of sample macros.

Ami Pro can import text from just about anything. It directly imports 26 different file formats and will attempt to import others, as well. The list of compatible formats includes not only word processors, but spreadsheets such as 1-2-3, Excel, and SuperCalc and databases such as dBase and Paradox. It can exchange files with other Windows applications through cut-and-paste Clipboard operations, DDE (Dynamic Data Exchange), and OLE (Object Linking and Embedding).

Ami Pro holds an edge when working with graphics files. You can do the usual scaling, moving, and rotating, but it also lets you manipulate gray-scale TIFF files by changing brightness and contrast, enhancing edges, and smoothing areas. Another plus is Adobe Type Manager, which greatly improves the appearance of text on the screen—especially for very large fonts—and makes available a wide range of fonts.

Ami Pro 2.0 is even better than the previous version. It is a good program right out of the box and an ideal choice for the user who needs a macro language. The combination of its native features, macros, and Adobe Type Manager give Ami Pro the wherewithal to handle any WYSIWYG word processing task.

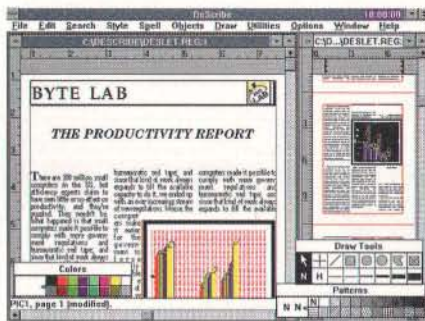

SUMMARY

DESCRIBE WORD PROCESSOR 3.0

PROS Operates like a page-layout program; permits a large number of open files; lets you undo a series of actions

CONS Style sheets are difficult to learn; graphics handling sometimes is slow

DESCRIBE WORD PROCESSOR 3.0

DeScribe, which runs under Windows or OS/2 PM (Presentation Manager), is part word processor and part DTP program. Once you get the hang of using it, this can be a good package for assembling newsletters and the like, but for mundane writing tasks, it's probably overkill.

The program is object-oriented in that it handles text and graphics in separate, movable "object" areas, or windows. A text object may contain only text; a graphics object may contain only imported graphics or drawn elements. You can combine the two types of objects on a page, selecting and moving the object windows to produce the layout you want. To change your view of the workspace, you move a sliding bar that zooms in or out, enlarging an area by 500 percent or reducing it to 10 percent of its original size.

DeScribe's editing screen has a typical Windows layout: four small toolboxes for patterns, colors, drawing tools, and text tools. You can drag the boxes around and put them anywhere on the screen or remove them, and you can choose to display the graphics toolboxes only when graphics objects are selected.

We used DeScribe's style sheets to set up the banner headline for the first page of our text newsletter. It proved to be a formidable task to learn how to create

style sheets for pages with adjacent text boxes of different widths. Even setting up a style sheet for a single line of text three columns wide isn't easy. On top of that, DeScribe sometimes has trouble creating a true drop cap (a larger than normal uppercase letter such as the one that appears at the beginning of this article); in several cases, the drop cap overlapped the character below it, text was not indented, or the first line of text was enlarged rather than just the first letter of the first line.

We also had minor problems with the program's spelling checker. First of all, it doesn't issue a prompt or message to tell you it has finished checking a document. More troubling, to recheck your document, you must exit DeScribe and then reopen the file.

DeScribe feels sluggish when handling text and graphics files on the same page. The program tends to redraw images after every carriage return during text entry, whenever you click out of a dialog box, and during cut-and-paste operations.

Selecting a graphic element does not always produce visible "handles" for moving an object, but even if it doesn't, you can move it with the mouse by dragging the cursor across the image. Resizing an image in a graphic object is very difficult when the handles are obscured by the borders surrounding the object. Cropping graphics is quite easy, though.

For those who forget to save their work periodically, DeScribe offers a snapshot feature that automatically saves your text at regular intervals—a boon for times when Windows crashes unexpectedly. When you reload DeScribe, the program asks whether you want to open this snapshot file.

DeScribe can import and export more than 40 text-file formats, including Ami Pro, 1-2-3, Word, MultiMate, Q&A Write, ASCII, WordPerfect, WordStar, XyWrite, and many more. It can also import a wide variety of graphics formats, among them DXF, GEM, CGM, PCX, PM and Windows bit maps, GIF, and WPG.

Unlike some of the WYSIWYG word processors, DeScribe has the feel of a DTP program. Like a few of the other word processors tested, it can be a little slow at handling graphics, but the package has some very powerful features, including the ability to open an unlimited number of files on-screen simultaneously and the ability to undo every change made to a document since the last save. This package undoubtedly will continue to improve with age.

continued

WINDOWS WORD PROCESSORS COMPARED

For WYSIWYG word processors to be truly useful for turning out good-looking text and page layouts, they need strong editing, formatting, and graphics capabilities. (● = yes; ○ = no.)

Product	Ami Pro 2.0	DeScribe Word Processor 3.0	Lotus Write for Windows 2.0	Microsoft Word for Windows 2.0	Professional Write Plus 1.0	WordPerfect 5.1 for Windows	WordStar for Windows 1.0
Company	Lotus Development Corp.	Describe, Inc.	Lotus Development Corp.	Microsoft Corp.	Software Publishing Corp.	WordPerfect Corp.	WordStar International
Price	\$495	\$495	\$199	\$495	\$249	\$495	\$495
Editing Features							
Spelling checker	●	●	●	●	●	●	●
Grammar checker	●	○	○	●	●	○	○
Thesaurus	●	●	●	●	●	●	●
Outliner	●	○	●	●	○	●	○
Mail merge	●	●	●	●	●	●	●
Undo	●	●	One level only	●	●	●	●
Math functions	●	○	○	●	○	●	○
Equation editor	●	○	○	●	○	●	○
Timed automatic save	●	●	●	●	●	●	●
Context-sensitive help	●	●	●	●	●	●	●
Draft mode	●	○	●	●	●	●	●
Max. number windows	9	Memory dependent	9	9	Memory dependent	9	1
No. file formats imported	28	39	27	14	4	16	30
No. file formats exported	19	41	19	12	6	16	30
Long-Document Features							
Creates index/table of contents	●	●	○	●	○	●	○
Cross-referencing	○	○	○	●	○	●	●
Page marks/bookmarks	●	●	○	●	○	●	●
Customization Tools							
Macro learn mode	●	●	●	●	○	●	○
Macro editor	●	●	●	●	○	●	○
Macro programming language	●	●	○	●	○	○	○
Customizable main menu	Icons only	●	Icons only	●	○	○	○
Dynamic Data Exchange	●	●	●	●	●	●	●
Object Linking and Embedding	●	○	●	●	○	○	○
Groupwork Editing							
Document notes	●	○	●	●	●	●	●
Redlining	●	●	●	●	●	●	●
Document summary	●	○	○	●	○	●	○
Formatting							
Style sheets	●	●	●	●	●	●	●
Conditional page breaks	●	●	●	●	●	●	●
Widow/orphan control	●	●	●	●	●	●	●
Automatic hyphenation	●	●	●	●	●	●	●
Snaking columns	●	●	●	●	●	●	●
Side-by-side columns	●	●	●	●	●	●	●
Kerning and tracking control	●	●	○	●	○	●	●
Document queues	●	○	○	●	○	○	○
Printing in background	●	○	○	○	○	○	○
Graphics							
No. file formats imported	12	28	12	28	11	16	9
Sizes/crops/rotates graphics	●	No rotation	No rotation	No rotation	●	●	●
Moves graphics frames	●	●	●	●	●	●	●
Flows text around graphics	●	●	●	●	●	●	●
Page preview	●	●	●	●	●	●	●
Draws lines/boxes/borders	●	●	○	●	●	●	●
Drawing tools/program	●	●	○	●	○	○	●
Table editor	●	●	○	●	○	●	●

MAC WORD PROCESSORS COMPARED

For WYSIWYG word processors to be truly useful for turning out good-looking text and page layouts, they need strong editing, formatting, and graphics capabilities. (● = yes; ○ = no.)

Product	MacWrite II 1.1	Microsoft Word 5.0 for the Macintosh	Taste 1.02C	WordPerfect Macintosh 2.1
Company	Claris Corp.	Microsoft Corp.	DeltaPoint, Inc.	WordPerfect Corp.
Price	\$249	\$495	\$129	\$495
Editing Features				
Spelling checker	●	●	●	●
Grammar checker	○	○	○	○
Thesaurus	●	●	●	●
Outliner	○	●	○	●
Mail merge	●	●	●	●
Undo	●	●	●	●
Math functions	○	●	○	○
Equation editor	○	●	○	○
Timed automatic save	○	●	○	●
Context-sensitive help	○	●	●	●
Draft mode	○	●	○	○
Max. number windows	Memory dependent	23	Memory dependent	Memory dependent
No. file formats imported	12	10	9	2
No. file formats exported	12	10	9	2
Long-Document Features				
Create index/table of contents	○	●	○	●
Cross-referencing	○	○	○	●
Page marks/bookmarks	○	●	○	●
Customization Tools				
Macro learn mode	○	○	○	○
Macro editor	○	○	○	●
Macro programming language	○	○	○	●
Customizable main menu	○	●	○	●
Groupwork Editing				
Document notes	○	○	○	○
Redlining	●	●	●	●
Document summary	○	○	○	○
Formatting				
Style sheets	●	●	●	●
Conditional page breaks	●	●	●	●
Widow/orphan control	○	●	○	●
Automatic hyphenation	●	●	○	●
Snaking columns	●	●	●	●
Side-by-side columns	●	●	●	●
Kerning and tracking control	○	●	●	●
Document queues	○	●	○	○
Printing in background	○	○	○	○
Graphics				
No. file formats imported	3	4	2	3
Sizes/crops/rotates graphics	●	●	●	●
Moves graphics frames	●	●	●	●
Flows text around graphics	○	●	●	●
Page preview	○	●	●	●
Draws lines/boxes/borders	○	●	●	●
Drawing tools/program	○	●	●	●
Table editor	●	●	○	●

WORD PROCESSORS

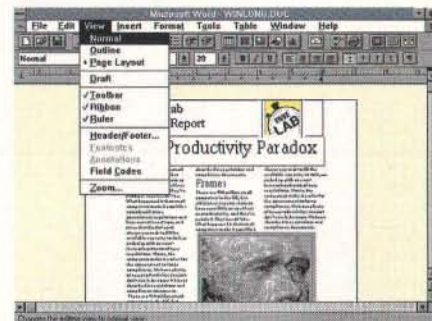

SUMMARY

MICROSOFT WORD FOR WINDOWS 2.0

PROS Ribbon bar makes formatting easy; drag-and-drop operation; follows a page-template approach; outliner; easy to learn; OLE

CONS Doesn't support Multiple Document Interface; won't do columns of varying widths; RAM-hungry; prefers at least a 386

MICROSOFT WORD FOR WINDOWS 2.0

Microsoft Word for Windows is one of the most sophisticated, powerful, and easy-to-use WYSIWYG word processors on the market. It doesn't look so friendly when you first fire it up, though, because the screen looks cluttered. At the top of the screen are a menu bar with pull-down menus, a toolbar with cryptic icons for commonly used functions, a ribbon bar for changing the appearance of text, and a ruler bar for aligning text. You'll need practice to remember the function of each icon.

If you don't like this sort of interface, you can customize it, redefining the keyboard shortcut commands, pull-down menus, and toolbar. This customization can apply globally to the entire program or to only a particular template. You also can turn off the toolbar, ribbon bar, and ruler bar.

Word lets you open up as many as nine windows, or panes, each of which can contain the same file. Any changes made in one pane appear in the others. Or, you can open nine files simultaneously—if you have enough available RAM. You can't convert a pane to an icon because Word, oddly, doesn't support Windows' Multiple Document Interface.

Based on the template concept, Word is a sort of super style sheet. You can create your own templates or edit the demo templates included in the package.

Creating the sample newsletter with Word for Windows was surprisingly easy. The steps you follow are much like those for Ami Pro and Lotus Write. After importing the sample text file, you pull down the Format menu, click on the Columns selection, and enter a 3. Text rearranges itself in three-column format. Then you click on the Insert menu item, select the Frames option, and insert a frame for the title of the newsletter, the subtitle, and the graphic element. You'll need to do some experimenting in layout mode to get the font and type size the way you want them.

Inserting a graphic into a frame proceeds smoothly; Word translates the file format, automatically resizing the graphic to fit its frame. Text wraps around any frames you place in the layout.

A particularly handy feature is Word's use of clicking and dragging to move selected text anywhere within a document. You simply define a block of text with the mouse cursor, hold down a mouse button, and drag the cursor to where you want the text to reside—a very intuitive method for doing rough editing.

Like Ami Pro, Word makes it easy to use outlines and reorganize documents. The Outline view lets you create an outline and then enter text under the various subheads. You can collapse an outline so that it shows just the headings. When you rearrange the headings and their associated subheads, the text automatically moves to the new location in the outline.

Word for Windows can import 14 different file formats from other applications. Either directly, or via separate filter programs, Word accepts files from just about any PC source. It can import a number of graphic file types, as well, including the usual Windows formats, EPS, TIFF, CGM, HPGL, DrawPerfect, Micrografx Designer, AutoCAD 2D, and Lotus 1-2-3 Graphics.

The program can work with other Windows applications in several ways. Besides the usual cutting and pasting via DDE, which lets you swap information with Windows applications running in the background, Word also supports OLE. OLE basically embeds data from another OLE-capable application in your document. If, for instance, you want to make changes to an equation embedded in your document, you first would create the object using the Equation Editor and then embed it in your document; to edit the equation, you double-click on it and the Equation Editor fires up.

In our tests, Word for Windows did not exhibit any serious bugs. However, we have received reports from other users

that, as with Ami Pro, problems surface when macro files larger than 2 KB are used. Also, because of a bug in the word counter, Word for Windows cannot compute the length of files containing more than 65,535 words. When counting words in larger files, the counter rolls over to zero. (See Jerry Pournelle's User's Column on page 101) None of these are serious flaws.

Word for Windows is a good program that has gotten better with age. If you want a WYSIWYG word processor that is powerful and easy to use, get Word for Windows.

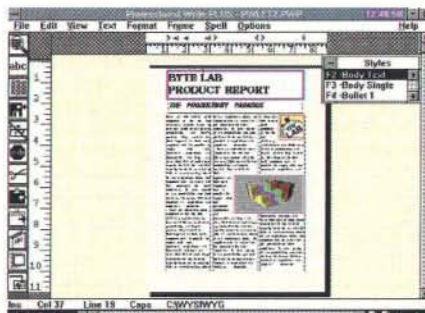

SUMMARY

PROFESSIONAL WRITE PLUS 1.0

PROS	Easy to learn and use; manipulation of graphics and frames is fast and intuitive
CONS	Cannot combine text and graphics in the same frame; snafus crop up when the text in a frame is reformatted

PROFESSIONAL WRITE PLUS 1.0

Software Publishing's Professional Write Plus aims to make it easy to set up documents such as our test newsletter. Starting up the program for the first time may conjure up thoughts of Ami Pro; that's no surprise because it's based on Ami. The screen display—complete icon bar and styles box—looks much like Ami's, and you can customize the interface to display only the icons you use frequently. Sailing into the first session with this package produces that friendly familiarity that comes with a really intuitive product.

The program makes it easy to get started creating documents by offering 24 predefined templates for common docu-

ments, including newsletters, reports, memos, and letters. Of course, you also can customize your own style sheets.

It's a blessing to find a word processor that handles graphics with ease and simplicity. Professional Write uses the frame method of handling images within documents, and Software Publishing has made this process easier than in many other packages. You can create frames and import graphics, scaling, moving, and rotating them effortlessly and with minimal learning time. Instead of selecting a special icon or tool, you simply click and drag on the frame's handles or the graphic image to stretch it, or click and hold anywhere in the frame to move it easily in any direction. But you cannot put text and graphics within the same frame.

With Professional Write Plus, you don't need a T-square to design documents that look as if they were produced with DTP software. You simply select the frame and define how text will wrap around it, or you can create interesting effects by superimposing transparent or opaque graphics on text.

To scale a graphic and display it at the right size, you can simply click twice on the image and begin setting up the parameters in the sizing dialog box. You can define images to fit in a frame, to remain at their original size, to be reduced or enlarged by a particular percentage, or by typing in the frame's measurements in inches, centimeters, or picas and points.

Professional Write can import graphics in SDW (Ami Professional Draw), CGM, EPS, ART (First Publisher clip art), SYM, PCL, PIC, MAC, PCX, TIF, WMF, and bit-mapped Windows formats. If you want to change the orientation of the graphic, you can rotate it, as long as it's in one of the following formats: ART, PCL, MAC, PCX, TIFF (non-gray scale), and Windows' Clipboard bit maps.

For ensuring accuracy in the words you type, Professional Write provides an integrated spelling checker, an on-line thesaurus, and the Grammatik for Windows grammar checker.

Creating our sample newsletter with Professional Write Plus went well, except for two minor snags. When entering text in a frame for the subtitle, we selected a 36-point font, and instantly the text disappeared. It was nowhere to be found and Professional Write wouldn't let us enter more text. The only option was to delete the whole frame and start over. Following the manual's procedure for creating a title did not create a line of text that spanned three columns.

continued

Aside from these problems, Professional Write Plus is a good product for writing, editing, formatting text, and laying out pages. It's very intuitive, easier to learn than other packages we looked at, and superb at handling graphics. Software Publishing has managed to combine power and ease of use in a solid WYSIWYG word processor.



SUMMARY

WORDSTAR FOR WINDOWS 1.0

PROS Buttons and toolbox make operations easy; can link text across different pages; includes drawing tools

CONS Existence of separate drawing and editing modes causes confusion; navigation between modes cumbersome; can't open multiple documents

WORDSTAR FOR WINDOWS 1.0

WordStar for Windows is capable of producing complexly formatted pages using a host of on-screen icons and menu commands. The program uses a frame-based approach and has some advanced features for text editing, page layout, and typography.

WordStar's opening display, with its host of options, is either impressive or cluttered, depending on your preferences. But even those who enjoy having numerous icons and menu choices, will find the program unwieldy at times. It offers 40 different cursor and marker types: object editing tools, text and frame editing tools, and tab alignment markers. The toolbox includes a rotation tool as well as basic drawing tools for creating rectangles, circles, ellipses, lines, and arcs.

WordStar for Windows operates in many different modes, and keeping track of which mode you're in isn't always

easy. In Edit mode, you enter and manipulate text and have access to the Graphics menu for drawing, importing images, and working in a graphics frame. There's also a Draft Edit mode, which handles only text. In the program's Frame mode, you can create and manipulate frames containing graphic elements, tables, EPS graphics, and text frames. In Page Editor mode, you may type in text; work with graphics, data, and tables; or run the spelling and grammar checkers.

If all the text and graphics editing capabilities of WordStar for Windows worked together smoothly, this word processor would be formidable competition for other products that already have simplified layout procedures by allowing text and graphics to be manipulated within the same mode. You can link stories across multiple pages so that text flows forward to the next frame. Likewise, you can link graphics and tables if they are too large to fit on one page. WordStar automatically wraps text around graphic elements.

The program imports bit-mapped images at their original size and can scale them to fit the graphics frame only when you are working in the Frame mode or when you access the Layout commands. WordStar switches automatically to Frame mode when you select the Scaling option. The package can import a variety of graphics file formats.

Unfortunately, WordStar's ability to handle text and graphics on the same page is poor. Highlighting three columns of text is very difficult, and the program redraws the screen frequently and generally acts erratically. After reformatting an area of text, small highlighted sections may still remain. To deselect them, you must repeatedly click in these highlighted areas until they no longer are marked. You may even have to redraw the screen to eradicate them.

We encountered one minor annoyance in working with the program. Using the Save As option to save a file to a floppy disk when you already have saved it during your current computing session almost always mysteriously produces an error message indicating that the file already is open and can't be accessed. When this happens, you have to return to the File menu and use Save instead.

WordStar for Windows wants to join the ranks of desktop publishers. Its learning curve may be steep, and it can be tricky keeping track of modes and all the different pointers and markers. But once you've reordered your way of thinking, you should be able to use WordStar to produce crisp-looking output.

MACINTOSH PROGRAMS



SUMMARY

MACWRITE II 1.1

PROS Fast, responsive; easy to use; uncluttered interface; great price

CONS Inflexible columns; indirect graphics scaling

MACWRITE II 1.1

As a straight-ahead word processor, it's hard to beat this classic. It's fast, has a clean interface, is easy to use, and is very stable. What it's not is a flexible document designer.

You can set up a multicolumn page easily enough. (All layout commands are issued through dialog boxes. Settings such as line spacing, tabs, and justification can be controlled through icons below the ruler at the top of the screen.) But MacWrite wouldn't let us construct our complete test document, which calls for a full-width banner headline on the first page. If you choose a three-column page layout, the entire page must have three columns. You can't set up an area that deviates from that. You can get a page-wide column at the top by setting up a header, but that header will appear on every page. You can't have it appear only on the first page, which is what you'd probably want with a newsletter or brochure. If there's a way to have one big column hovering over multiple columns, the manual doesn't reveal it. This is an unfortunate limitation, even for the user who's not partial to complex page designs.

Although MacWrite doesn't always let you have what you want, it does generate output that matches what you see on the screen. A line that's 2 inches on the screen is 2 inches on the printed page, for



example. Imported images, however, sometimes turn out streaked on a printout.

MacWrite II is good at bringing in graphics. You can import PICT or MacPaint images through the Clipboard, or you can bypass copying and pasting by choosing the Insert File menu. The program plops the graphic at the point where the cursor sits. You then can move it as if it were a text character, by adding spaces with the spacebar, or by clicking on it and moving it like an object. If you need to scale an image, you type the appropriate values into a dialog box. This isn't as easy clicking on an image's handles and enlarging or reducing the image, but it works.

MacWrite II does not have the button bars of some of its competitors; instead, you change fonts and type sizes and styles through menus. Other operations, such as building tables, are accomplished through dialog boxes. The interface looks refreshingly plain when compared to the front ends of Word and WordPerfect.

MacWrite II is a fine text editor that's easy to learn, packs all the text-manipulation tools you expect from a word processor, and includes all the things a writer needs: a 100,000-word dictionary, 220,000-word thesaurus, and spelling checker that does word counts. Claris says MacWrite can handle documents with as many as 1000 pages (We've used it with a 150-page manuscript and encountered no problems except slow file loading). Other pluses are mail-merge capability, ease of setting up form letters, painless footnoting, and the speed with which it scrolls through a page. Claris' translation filters let you pull in text from just about any Mac program. You can take a file written in Word, for example, pull it into MacWrite to edit it, then ship it back to Word.

Right now, the program can't do flexible page layout, but all this could change with the new "professional" version of MacWrite, due out sometime soon. While we'd hate to see old friend MacWrite get bogged down in featuritis, it would be nice if Claris fixed the program's inflexible, one-style-fits-all column structure. In anticipation of the new release, Claris has reduced MacWrite's price by half to \$129, making this one of the best bargains in Mac software.

If you want to pour your text into fancy pages, without firing up PageMaker or FrameMaker, MacWrite II will frustrate you. On the other hand, if your main editing job is flowing text and a few graphic elements onto a multicolumn page, MacWrite will do you fine.



SUMMARY

TASTE 1.02C

PROS Strong page-layout functions; easy to use; includes drawing tools; permits different layouts on facing pages; good price

CONS Forces you to switch between editing and drawing modes; inconsistent word wrapping

TASTE 1.02C

DeltaPoint's Taste is a mixture of word processor and desktop publisher. The package handles simple word processing tasks well, but feels more like a DTP package.

With Taste, you set up your document's layout by specifying margins and column widths in a dialog box or by sliding markers on a graphical representation of a page. This setup makes it easy to create multiple columns like the ones in our newsletter. From this layout mode, you also can set up such things as space for a banner headline (what many word processors call a header). The template you establish may be applied to any or all pages in your document. Taste lets you set up different layouts for facing pages. Making changes to your page layout is easy.

To get text into your document, you can type it right on the page or pull it in from another word processor. The program can import ASCII text or files from other Mac word processors. Because the package comes with Claris' file translators, it can handle just about any foreign file format. As a text editor, Taste is responsive.

Taste includes a set of basic drawing tools similar to the ones you'd find in PageMaker for generating geometric forms. These tools are good for putting boxes around text and adding horizontal rules, shaded areas, and arrows, but the polygon-, curve-, and arc-drawing pens let you create even free-form graphics. Taste

can import images in PICT or EPSF format, but not those in TIFF format.

All graphics work is done in Taste's drawing mode, which you hop into by clicking an icon at the bottom of the screen. Taste handles graphics as objects, so you can pick them up to move them, resize them, and generally manipulate them with ease. If you've used any object-based art packages, you'll get the hang of drawing mode immediately. You also can work with text within the drawing layer, which makes this a good place to work while putting together banner headlines and logos. The program treats the text in this layer the way it treats a graphic: as an object. Once you have the graphic the way you want it, you click back into text mode and the graphic is placed on the page.

As you'd expect from a good desktop publisher, Taste will let you wrap text around or inside a graphic. You simply select the graphic, then click on the "wrap around" or "wrap inside" command. This is easy enough, but the action is inconsistent. We frequently hit snags with this operation, with the text refusing to wrap text around the sides of an image. Instead, it stops flowing at the top of the image's boundary, then begins again at the bottom of the image, leaving white space on the sides of the graphic instead of flowing the text. The automatic wrap, when it does work, is limited to graphics generated in Taste; with imported graphics, you have to go in and add or remove spaces, or you can trace the imported image and turn it into a Taste graphic. This can be done, but the process isn't pretty.

Formatting text with Taste works much like it does with most other Mac word processors. You can select a chunk of text and set attributes such as font choice and type size, or you can set up style sheets that automatically do the formatting. Taste has the usual selection of type styles, including two that some of the others don't: boxed and redlined. In addition, the package lets you adjust the spacing between letters (kerning) and can handle type sizes as large as 127 points.

The program has the tools a writer needs, including a word counter, spelling checker, dictionary, thesaurus, automatic numbering of footnotes, automatic page numbering, hyphenation, and a page-preview mode from which you can make changes. It is an ideal package for the person who has to write and design documents. If the material you write often gets poured into a page-layout program, you can save some time, effort, and money with Taste.



SUMMARY

MICROSOFT WORD 5.0

PROS Ribbon bar provides easy access to operations; robust editing tools; drag-and-drop capability; Equations Editor; System 7.0 savvy

CONS Exhibits irregularities when adding graphics; mixing layout styles isn't easy; scrolling can be slow

MICROSOFT WORD 5.0 FOR THE MACINTOSH

This newest version of the big gun in Mac word processors makes it easier to manipulate text. The program is now more visually intuitive and probably easier to get around in than Word 4.0 was. Like Word for Windows, Word for the Macintosh now has a formatting bar, called a ribbon, across the top of the screen. This horizontal ribbon holds icons and menus representing the most frequently used functions. Here you can quickly access commands and options with a single click. The font menu, type sizes, styles (boldface, italics, and so on), and column formats all reside in this ribbon. If you do a lot of experimentation on the page with type styles and sizes, this formatting ribbon can save you a lot of time and many mouse-clicks.

In terms of editing operations, the biggest change to Word is its ability to drag and drop text. This capability, introduced in the latest Word for Windows, lets you select a block of text, move the cursor to the place you want it to go, and release the mouse button to drop the text at its new location. This is far more efficient than copying, cutting, and pasting. If you work on documents that often involve rearranging text, drag and drop can be a big time-saver.

As a program for setting up documents such as our test newsletter, Word 5.0 works well. It lets you do everything necessary to generate a multicolumn

page with mixed type styles. With this new version, you're no longer limited to a type size of 128 points; Word 5.0 can handle type as big as 16,000 points, which you'll probably never need unless you're editing a billboard.

Mixing layout styles isn't as easy as it is with Taste, but Word can do it. If you want to vary a section of your page—inserting a two-column text box on the three-column page, for instance—you have to set up a frame using a dialog box. You can place graphics or text in a frame; however, the procedure for implementing frames is not intuitive. Expect to spend some time with the manual.

While Word 5.0 has all the graphics functions you'd need for designing a good-looking document, we ran into snags with this part of the program. Images did not always paste in the way we expected. Sometimes we'd get only part of the image, surrounded by a big frame. Scaling the image by manipulating its handles would redraw the image properly only some of the time. And although the documentation says you can drag and drop images, we couldn't always get the image to snap into its new location. These graphics-related malfunctions are frustrating; let's hope they're bugs that get fixed in 5.1.

If your documents often require mathematical formulas, you'll appreciate the Equations Editor in Word 5.0. It's adapted from Design Science's Math-Type program. While you could do complex equations before, with Word's typesetting language, it's much easier with the new editor. Most of the work in setting up an equation may be done by clicking on choices in a palette of symbols.

Like the new WordPerfect, Word 5.0 is a strong System 7.0 application. It takes advantage of Publish/Subscribe, so you can set up links with other Mac programs that take advantage of this feature.

As a text editor, Word is excellent. It's got all the tools a writer needs, including a spelling checker, grammar checker, outliner, indexer, and automatic table-of-contents generator. Word also can handle all the tasks involved in setting up complex pages. It may not do this as intuitively as some other programs, but it will get the job done. Our only concern is with the graphics-manipulation functions. They require some time to learn, and they don't always work as expected.

Word users are pretty much Word users for life. Our opinion isn't likely to sway anyone to try another program. But we will offer some advice about upgrading. Buy the upgrade to version 5.0

(\$129) if you need System 7.0 functions and inter-application connections, or if you want such features as the ribbon bar and drag-and-drop operations.

If you're looking for your first Mac word processor, you really can't go wrong with Word. It's a good, intuitive text editor. And it's backed by a company that you can bet is going to be around for a while.



SUMMARY

WORDPERFECT MACINTOSH 2.1

PROS Packed with tools; push-button controls; lets you embed QuickTime movies; System 7.0 savvy

CONS Problems flowing text; requires you to switch between editing and drawing modes

WORDPERFECT MACINTOSH 2.1

With this latest version, WordPerfect has bestowed System 7.0 savvy on an already feature-laden word processor. The program now can connect with other Mac applications through Publish/Subscribe and support for Apple Events.

But the neatest trick this pony now does is work with QuickTime, Apple's operating system extension for handling multimedia data, such as video and audio sequences. With QuickTime support, you can embed frames of moving video in your WordPerfect document. Movies can be a part of your page. This is the first word processor that can handle QuickTime files.

WordPerfect is a top-of-the-line word processor when it comes to supplying all the tools a writer needs: variable type styles and a dictionary, thesaurus, spelling checker, indexer, and word counter. Formatting text and pages is relatively easy, and most operations are available from the ruler at the top of the



page. Like Word, WordPerfect has push-button controls; you click on an icon to set the type of columns you want, the number of columns, the way the text aligns, and so on. You can change column widths either by sliding markers along the ruler or by setting specifications through the Page Format menu and dialog boxes. (The latter approach is more precise.) You set up style sheets the way you would in other WYSIWYG word processors or in DTP packages, by specifying type sizes, fonts, indents, headings, and so on in menus and dialog boxes.

Getting graphics onto the page is relatively simple. WordPerfect can pull in most common formats, either by copying them and pasting them in or through the Insert menu. Once you've got the image in your document, you can move or resize it by pushing or pulling handles. You also can anchor a graphic to a particular page or paragraph, which is helpful if you want to keep an image next to some text associated with it.

WordPerfect says the program will automatically wrap text around a graphic, but this function didn't operate consistently. Sometimes the text runs right across the image; at others, it bumps right against it. You can go in and manually insert spaces to make things look OK, but this is hardly automatic word wrapping.

This failure to do as it's told is a serious problem with WordPerfect 2.1—so much so that we had difficulty generating our test document. When we poured text into a three-column layout, for example, the text sometimes flowed across the width of the page, ignoring column boundaries. Other times, the text smashed into graphic elements or just disappeared. But we can say this: The program definitely is WYSIWYG. When text got jumbled on the screen, it came out jumbled when printed.

These problems didn't come up when working with a one-column page that was mostly text. So, if your documents are rather plain memos, reports, or books, WordPerfect is fine. If most of what you write requires multicolumn pages that contain graphics, be prepared to go in and do some twiddling.

We expected to find snags in the QuickTime components, since that's such a new technology. But that part of the program worked flawlessly. You insert a movie clip the way you would a still image. Once the frames are on the page, you can pick them up and move them around like any other graphic. You also can resize the video frames the way you would any scalable static image.

QuickTime technology is a harbinger of

documents of the future. Imagine embedding scalable video frames in your next newsletter or company brochure. Imagine sending someone a letter terminating a contract or relationship; at the bottom of the letter is a QuickTime frame taken from a popular science fiction film; the recipient clicks on the frame and the image comes alive: "Hasta la vista, baby."

What You Want Is What You Buy

If you want visually appealing, professional-looking documents, without any surprises when you print, you need a WYSIWYG package. For the multitudes of users moving to or starting out with a graphical interface, WYSIWYG makes perfect sense. New users will find it a lot easier to get down to editing and formatting text with a graphical program. Managers at corporate installations agree that novices can be producing documents in much less time with a GUI editor than with the old command-line kings such as WordPerfect and WordStar. Training is not a trivial issue.

For Windows users who don't already have a faithful word processor, we recommend—after grueling debate—Microsoft Word or Ami Pro. We say grueling debate because both packages have staunch advocates here. Word has a very slight edge with its interface, its drag-and-drop editing style, its simple customization of menus and icons, its ease of importing text and graphics in a variety of formats, and its superior documentation. Picking between these two is a highly subjective decision only you can make. Ami Pro certainly is no less capable than Word. It can do anything Word can do. And, due to its Windows heritage, it felt more stable and more responsive to some of us. We highly recommend that you not buy either without taking a test drive.

WordPerfect 2.1 is one of the top two Mac word processors. It will let you produce some sophisticated-looking pages, and it has all the power tools a writer could need. It has a macro language and exploits System 7.0, and it can handle any kind of document, from newsletter to book-length manuscript. On top of that, its innovative support for QuickTime movies is the coolest thing added to a mainstream Mac application this year. But the program sometimes misbehaves when flowing text or working with graphics. When WordPerfect fixes these flaws, we can recommend WordPerfect for the Mac without reservation.

Word 5.0 cruises along like a breeze during most writing and editing jobs. It's fast and responsive. The push buttons at the top of the screen let you do most edit-

ing and formatting operations without having to thumb through menus or work through dialog boxes. Although it's no replacement for a page-layout package, Word 5.0 can handle fairly complex page designs. It supports all the deluxe System 7.0 capabilities. And it's used by tons of Mac owners, so if you run into a problem, you can find help. As a writing and editing toolkit for the kinds of writing most people do, Word 5.0 is the one. ■

D. Barker is a BYTE editor covering applications software. David L. Edwards is a consultant to the BYTE Lab. Stan Wszola is a BYTE Lab testing editor. They can be reached on BIX as "dbarker," "dedwards," and "stan," respectively.

COMPANY INFORMATION

Claris Corp.

5201 Patrick Henry Dr.
Santa Clara, CA 95052
(408) 727-8227

Circle 1105 on Inquiry Card.

DeltaPoint, Inc.

200 Heritage Harbor, Suite G
Monterey, CA 93940
(408) 648-4000

Circle 1106 on Inquiry Card.

DeScribe, Inc.

4047 North Freeway Blvd.
Sacramento, CA 95834-9954
(916) 646-1111

Circle 1107 on Inquiry Card.

Lotus Development Corp.

55 Cambridge Parkway
Cambridge, MA 02142
(800) 343-5414

Circle 1108 on Inquiry Card.

Microsoft Corp.

1 Microsoft Way
Redmond, WA 98052
(206) 882-8080
fax: (206) 936-7329

Circle 1109 on Inquiry Card.

Software Publishing Corp.

3165 Kifer Rd.
P.O. Box 54983
Santa Clara, CA 95056-0983
(408) 968-8000
fax: (408) 980-0729

Circle 1111 on Inquiry Card.

WordPerfect Corp.

1555 North Technology Way
Orem, UT 84057
(800) 451-5151
fax: (801) 222-1990

Circle 1112 on Inquiry Card.

WordStar International

201 Alameda del Prado
P.O. Box 6113
Novato, CA 94948
(800) 227-5609
fax: (415) 883-1629

Circle 1113 on Inquiry Card.

HARDWARE

Color at a Reasonable Price

TOM THOMPSON

Most wine grows finer with time. The same maxim applies to color PostScript printers: They've definitely improved over the years. The first color PostScript printer was QMS's ColorScript 100, introduced in 1988. It was a big 112-pound beast that was so slow that some scanned images took up to 45 minutes to print. The output was nothing to write home about, but the colors made the printed pages stand out far more than any black-and-white output from a conventional laser printer. QMS asked—and got—\$25,000 for its printer.

Today, you have a choice of color PostScript printers that are loaded with features and impressive speed. More important, many are priced under \$8000. These printers achieve their low cost through the use of thermal-wax-transfer technology—the same technology as in the ColorScript 100. (For more information on how thermal-wax transfer works, see the text box "Hot Wax" on page 320.)

The BYTE Lab evaluated seven thermal-wax printers that fall in the under-\$8000 price class: Tektronix's Phaser II PXi, Brother International's HT-500PS, Seiko Instruments' ColorPoint PS, NEC Technologies' ColorMate PS Model 40, Océ Graphics' G5241-PS/4, CalComp Computer Graphics Group's ColorMaster Plus 6603PS, and General Parametrics' Spectra*Star Model 430.

All these printers work with either a Macintosh or a PC. Most have three I/O ports—a LocalTalk network connector, a Centronics parallel port, and a serial port—that facilitate connections to any desktop computer. The exceptions to this arrangement are Seiko's ColorPoint PS, which comes standard with only a parallel port, and Océ's G5241-PS/4, whose one DB-9 connector does double duty as a serial and LocalTalk port.

Many of these printers also have a 50-pin SCSI connector that's used to hook

up a hard drive to the printer. The hard drive stores outline fonts and caches bit-mapped fonts the printer creates during a print job. This setup saves time: Rather than tying up your computer with downloading different fonts to the printer as it demands them, the printer has to go only as far as the hard drive to obtain the fonts it needs. The exception here is General Parametrics' Spectra*Star Model 430, which doesn't have a SCSI port.

In terms of software support, most vendors supply the appropriate printer drivers. For the Mac, this is a modified LaserWriter driver: Usually, resources are added that support the special page-size areas these printers use. For Windows, you use either the standard Windows PostScript driver or a modified one that's supplied on a floppy disk.

The printers range in weight from the lightweight 39-pound ColorPoint PS to Tektronix's hefty Phaser II PXi. At 73 pounds, it takes two people to carry it.

Both the NEC ColorMate PS Model 40 and the CalComp ColorMaster Plus 6603PS angle their input and output paper trays vertically for a smaller desktop footprint. The other printers have paper trays that jut out from the side, take up room, and set up the situation to bang a passing hip if the tray happens to protrude into a high-traffic area.

Although all seven printers use the PostScript language to create output, only three of them use Adobe interpreters. The rest of the printers use PostScript clones, with two of the four using the PhoenixPage interpreter. All the printers have an output resolution of 300 dots per inch. (See the table for a complete list of printer features.)

Put to the Test

In addition to output quality, an important review factor for these printers is performance. A printer should be able to produce gorgeous results without taking

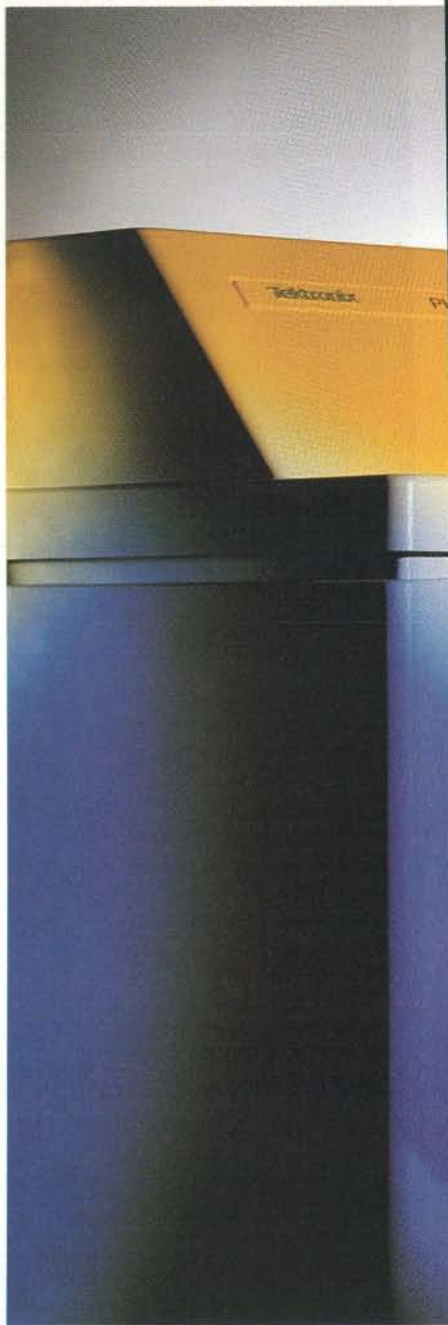

inordinate amounts of time doing it.

Measuring printer performance can be tricky, however. If a printer is slow, is it the result of the application that's printing the page, the printer driver, the network, the printer's PostScript interpreter, the print engine, or a combination of all the above?

There are ways to minimize the interaction of these components of the printing process. I eliminated network overhead by printing from the parallel port of a 12-MHz 286 PC. Next, I took a 2.5-

BYTE ACTION SUMMARY

■ WHAT THERMAL-WAX-TRANSFER PRINTERS DO

These printers use PostScript and thermal-wax transfer to produce three- or four-color images.

■ LIKES

They are easy to set up and faster than other color-printer technologies in this price range.

■ DISLIKES

The special paper that they require for the wax to properly adhere to a page drives up printing costs. The wax-based pigments can be easily scratched and are prone to flaking off the page.

■ RECOMMENDATIONS

For high performance and high quality, Tektronix's Phaser II PXi is the way to go, with a fast RISC processor and good dithering algorithms. For higher speed at lower cost, but at the expense of image quality, consider NEC's ColorMate PS Model 40. For better image quality at the expense of performance, check out CalComp's ColorMaster Plus 6603PS.

■ PRICE

Brother HT-500PS, \$4995

CalComp ColorMaster Plus 6603PS, \$5495

General Parametrics

Spectra*Star Model 430, \$6995

NEC ColorMate PS Model 40, \$5899

Océ Graphics G5241-PS/4, \$6990

Seiko ColorPoint PS, \$4999

Tektronix Phaser II PXi, \$7995

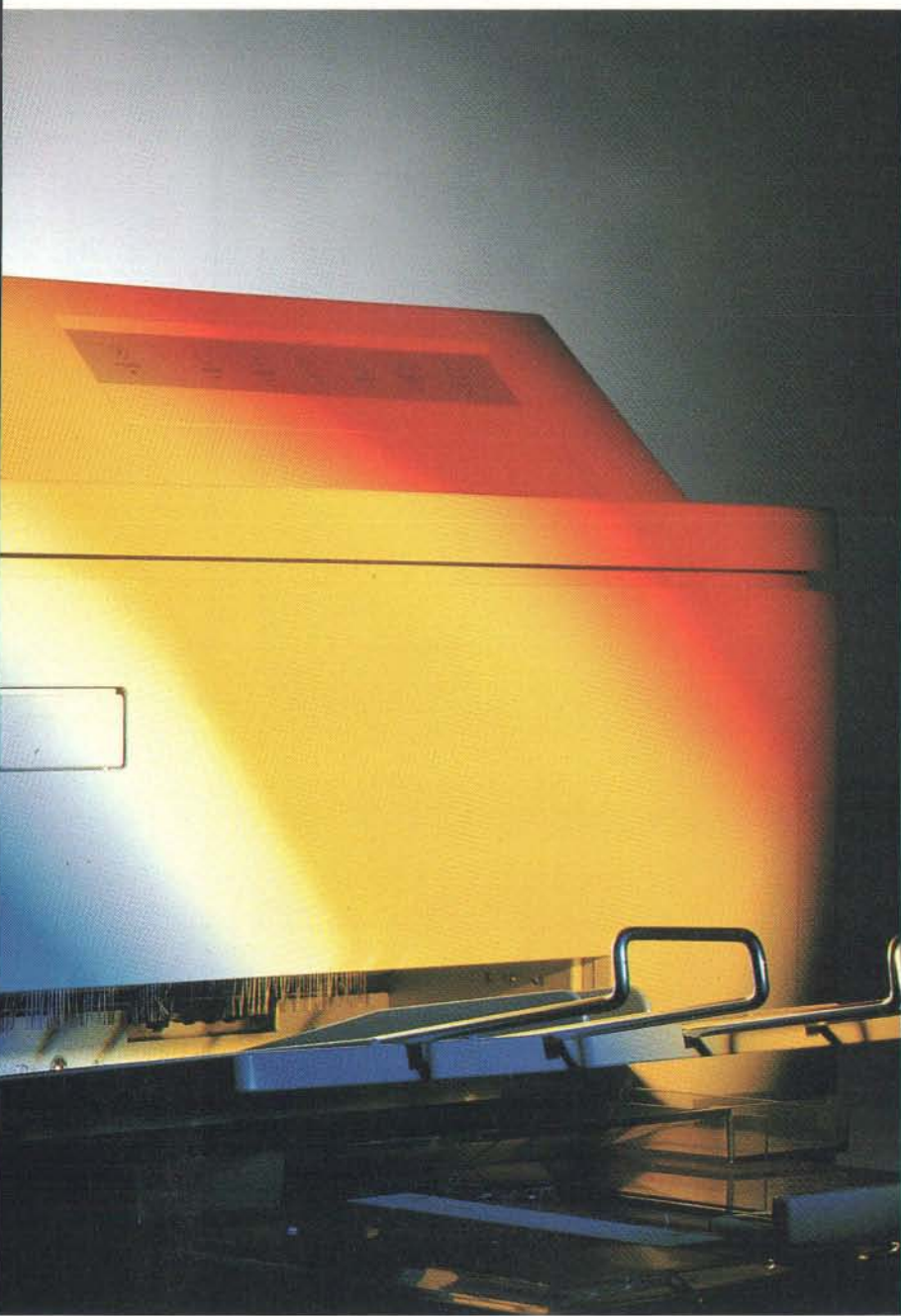

MB Mac PageMaker 4.2 document with a mixture of text, Adobe Illustrator 3.2 graphics, and TIFF images and printed it to disk as a PostScript file. I did the same thing with a 2.75-MB scanned image in Adobe Photoshop 2.0 and a 198-KB CorelDraw 2.01L drawing.

I downloaded the PageMaker document from a Mac Quadra 900 on an isolated LocalTalk network consisting of just the Mac and the printer; the Photoshop document was downloaded from the PC. I measured the times from the start

of the jobs until the pages were ejected from the printers. These setups minimized the effects of the application overhead, other than those caused by the application doing the download.

To measure the processing speed of the PostScript interpreter, I cobbled together code fragments into a 9-KB PostScript program. The code did some gray-level dithering with text outlines, rotated text and colored the characters various hues, and then drew a color wheel that spanned the color gamut. At the wheel's

rim, I placed some text that was defined as a *clipping path*. I wasn't attempting to exercise every PostScript operator, but to perform a subset of operations that an art or page-layout application might occasionally use. Each test was timed by using the PostScript operator `usertime`.

Finally, because I normally don't save the output to a PostScript file and download it, I printed the PageMaker file and the Photoshop file from within their respective applications on the Quadra 900. The results are shown in the figure.

COLOR POSTSCRIPT THERMAL-WAX-TRANSFER PRINTERS

Color printer features. Colors indicate the types of ink ribbons the printer can use. Pantone licensing is important for those who need precise color matching.

Printer	Processor	RAM min./max.	Graphics modes	PostScript interpreter	Ports	Auto-port-switching	Colors	Resident fonts	Pantone-licensed
Brother HT-500PS	60-MHz 34010	5 MB/21 MB	PostScript, HPGL, HP-PCL4	BR-Script	LocalTalk (DIN-8), parallel, serial (DB-25), SCSI ¹ , external I/O	Yes	1, 3, 4	11	No
CalComp ColorMaster Plus 6603PS	16-MHz 960	6 MB/34 MB	PostScript	PhoenixPage	LocalTalk (DIN-8), parallel, serial (DB-25), SCSI	Yes	1, 3, 4	39	Yes
General Parametrics Spectra*Star Model 430	20-MHz 960	6 MB	PostScript, HPGL, Mitsubishi G370-10	SpectraStar PS	LocalTalk (DIN-8), parallel, serial (DB-25), "Satellite"	Yes	1, 3, 4	35	Yes
NEC ColorMate PS Model 40	16-MHz 68020	4 MB/8 MB	PostScript	Adobe level 1	LocalTalk (DIN-8) ² , parallel, serial (DB-25), SCSI	No	1, 3, 4	17	Yes
Océ Graphics G5241-PS/4	16-MHz 68020	4 MB/8 MB	PostScript	Adobe level 1	LocalTalk (DB-9), parallel, serial (DB-9) ³ , SCSI	No	1, 3, 4	35	Yes
Seiko ColorPoint PS	16-MHz 960	6 MB/22 MB	PostScript, HPGL	PhoenixPage	LocalTalk (DIN-8) ⁴ , parallel, serial (DB-9) ⁴ , SCSI (DB-25) ⁴	Yes	1, 3, 4	39	Yes
Tektronix Phaser II PXi	24-MHz AMD 29000	8 MB/18 MB	PostScript, HPGL	Adobe level 2	LocalTalk (DIN-8), parallel, serial (DB-25), SCSI	Yes	1, 3, 4	39	Yes

¹ Miniature delta ribbon connector.

² Also serves as RS-422 serial port.

³ LocalTalk and serial share same connector.

⁴ Optional.

BYTE BENCHMARK INDEXES

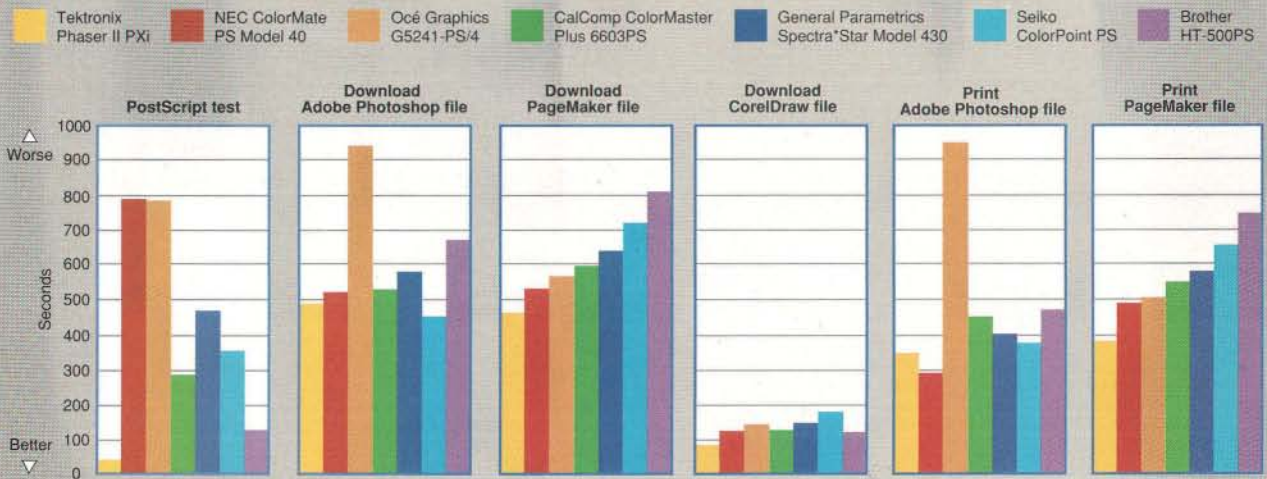

Timing results of the printers at various tasks. With the exception of the Photoshop file downloading and printing, the Tektronix Phaser II PXi was the fastest printer.

These printers are definitely faster than the four-year-old ColorScript 100, knocking out a scanned-image print in 6 to 15 minutes. The real speed demon is the Tektronix Phaser II PXi, thanks to its 24-MHz AMD 29000 RISC processor that powers a PostScript level 2 interpreter. Compared to the Phaser II PXi, it's a mixed bag as to which printers fared better on the various tests.

Interestingly, the two printers with Adobe level 1 interpreters—the NEC ColorMate PS Model 40 and the Océ G5241-PS/4—came in last on the PostScript benchmark test. My guess is that the problem lies in the use of a clipping path using text outlines. This was something that gave me trouble earlier on these printers and required a revision in the benchmark code.

However, both of these printers fared well on the PageMaker tests. Note that the G5241-PS/4 handled Photoshop's large color bit maps poorly, whether the file was received as a download through the parallel port or printed from the application via LocalTalk. What follows are short personal impressions—from a user's standpoint—of the seven thermal-wax-transfer color printers under review.

Page size	Weight	Price
A, legal	65 lbs. (29.5 kg)	\$4995
A, A4	55 lbs. (25 kg)	\$5495
A, A4, A4 special, legal	72 lbs. (32.5 kg)	\$6995
A, A4	55 lbs. (25 kg)	\$5899
A, A4	45 lbs. (21 kg)	\$6990
A, A4, legal	39 lbs. (18 kg)	\$4995
A, A4, A4 special, legal	73 lbs. (33 kg)	\$7995

tor is not the standard 50-pin type, but rather a miniature delta ribbon connector. Upon request, Brother will provide an adapter cable that allows you to connect conventional SCSI drives. An external I/O port with an optional I/O board lets you proof output on a Hewlett-Packard LaserJet or other black-and-white printer.

would make a good high-speed connection for big color jobs.

In terms of performance, the ColorMaster Plus 6603PS landed in the middle of the pack. On graphics, it seemed to do a good job on color dithering, placing second in appearance behind the Phaser II PXi.



CalComp Computer Graphics Group ColorMaster Plus 6603PS

If the name doesn't clue you in, one look at this printer lets you know that it's made by the folks who brought you computer plotters over the years. It's a solidly built machine.

It also has nice touches, like a locking latch that holds the cover open when you're changing the ribbon and a medium-loading arm that either moves the tray back so you can load it with paper or moves it forward to hold the paper snug against the feed rollers. As with the NEC ColorMate PS Model 40, angled vertical trays reduce the ColorMaster Plus 6603PS's desktop footprint, although the printer is as deep as Seiko's Color-Point PS, including its out-jutting receiving tray.

The six-button front panel with arrow keys lets you move easily through the setup menus. The LCD screen provides useful information, such as processing messages and the number of copies that have been printed. In the back, the ColorMaster Plus 6603PS has the standard I/O ports that use automatic port-switching.

Although the printer has two 50-pin SCSI connectors in the back, hinting that the printer might operate as a SCSI peripheral, this is, sadly, not the case. There's no SCSI printer driver available, and the manual states that the printer isn't capable of being a SCSI peripheral. This is too bad, since the SCSI port



General Parametrics Spectra*Star Model 430

This printer has a squat, Spartan design and resembles a small refrigerator. It has a good, verbose LCD screen. While the printer is idle, the display rotates through the printer's current settings (e.g., page size and emulation mode). It also authoritatively states that it's receiving and processing data during a print job. The six-button front panel is easy to understand, and the two arrow buttons help you to navigate through the setup menus easily.

The Spectra*Star Model 430 can sense incoming data on any of the I/O ports and receive data on the active port if the printer's hardware time-out is set. For certain print jobs, the processor can become so busy that you intermittently lose contact with the printer. This problem is documented in the manual, which also includes some suggested remedies. For instance, you can set the transmission retries to a large value (for Windows applications) or reconfigure the printer for the high-quality mode rather than the enhanced-quality mode (for Mac PageMaker 4.0).

This information really came in handy because it was necessary for me to change the printer settings as described in the manual to print the PageMaker test document from the Quadra 900. The Spectra*Star Model 430 had no difficulty printing the large Photoshop file later, however.



Brother International HT-500PS

This blocky unit has an LCD panel that provides a wealth of information: medium type, paper size, emulation mode, number of inks on the ribbon, and more. It also displays an exhaustive set of error messages, including buffer overflow, ignored data, and memory full—handy stuff to know when your print job inexplicably conks out. An audible alarm warns you of an error, including the all-too-often out-of-paper situation. The front panel also has an intimidating bevy of buttons and indicator lights. You can remove the back panel—I/O connectors and all—to add more SIMM RAM. RAM can be expanded from 5 to 21 MB.

The HT-500PS has the standard three I/O ports and a SCSI connector, with port-switching logic. The SCSI connec-

continued

Hot Wax

Although many printing technologies can produce color output, the chief advantage of thermal-wax transfer is that the procedure is simple and doesn't require liquids or toxic chemicals. The heart of the process is a transfer ribbon impregnated with wax-based colored inks. Inks of cyan, yellow, magenta, and sometimes black—the process colors—are laid out in a repeating sequence of page-size panels along the ribbon.

At the start of a job, the printer pulls in a page of paper. Rollers sandwich the ribbon between the paper and a print head that contains thousands of precisely controlled, minuscule heating elements (see the figure). As the paper and ribbon travel along the print head, certain elements heat up, melting dots of pigment onto the paper. These elements switch on or off, depending on the image's color information at that section on the page. The print head is as wide as the paper, so it can place the entire image onto

the page as the paper advances.

This pass lays down one color. To add the other colors, the paper must be shuttled back and forth across the print head again. Each time, a different color panel is brought into contact with the paper, and its pigment is layered onto the other colors.

As you might expect, there are some disadvantages to this process. First, building the image a layer at a time is slow. Still, this process is faster than

color ink-jet printers, where a print head must wipe back and forth across a page, assembling the image a strip at a time. Since a page must make three or four passes over the print head, paper alignment is crucial. If misregistration of the page—and, hence, the colors—occurs, the image is ruined.

In some situations, the transfer process can be wasteful. For example, if you're printing a PageMaker document with some magenta-colored text on the

page, whether or not the paper requires the other hues, they get pulled through the printing mechanism. Also, the wax pigments are soft and easily scratched. For the wax to adhere properly, a special paper must be used, driving up the printing cost. The average cost per page is about 50 cents.

Nevertheless, this is far cheaper than other color-printing technologies, such as dye sublimation or color laser. Thus, the mid-range color-printer market is dominated by thermal-wax-transfer printers.

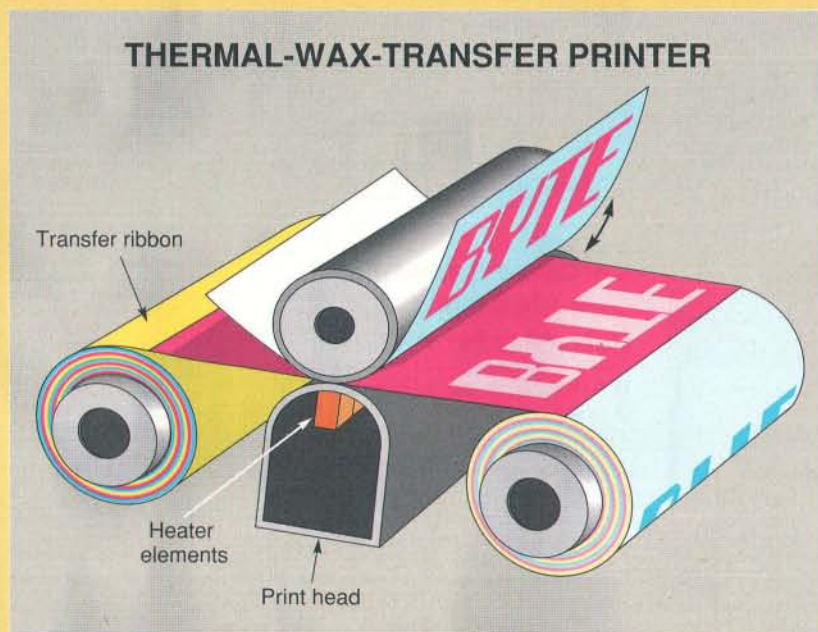

All thermal-wax-transfer printers work by heating colored wax (cyan, magenta, yellow, and black) and fusing it to a special paper. The print head melts tiny dots of color from a ribbon onto the paper. The paper must make four passes by the ribbon and heating element—one pass for each of the four colors.



NEC Technologies ColorMate PS Model 40

This printer has a sleek wedge-shaped design. The trays for paper and output are angled along the back of the wedge, giving the printer the smallest desktop footprint of the group. A thumb wheel at the front lets you easily adjust the ink intensity.

The four-button front panel with an LCD screen has been simplified to the point of being user-hostile. After several minutes of poking at the switches, I gave up and cracked the manual. Since the printer does not auto-sense for an active

printer port, you must configure the active I/O port through this unfriendly front panel. In its favor, the display prompts you to verify whether you really want to abort a print job, in case you have hit the controls accidentally.

The ColorMate PS Model 40's back panel can be easily removed to add an extra 4 MB of RAM and 18 more ROM-resident fonts. In spite of the printer's low marks on the PostScript benchmark, it performed well on other printing tasks. As the benchmark figure shows, it was one of the fastest printers in the review group, beaten only by the Phaser II PXi.

See gorgeous color.

Print gorgeous color.



If you've ever wished you could afford to print in vivid color, the new Canon Color Bubble Jet™ printers are for you.

The first thing you'll notice is the brilliant, rich color. That's because both the BJC-800 and the BJC-820 print up to 360 dpi using four snap-in ink cartridges: black, cyan, magenta, and yellow. So you get true black and richer darker shades.

You'll also admire these printers' versatility. They print on virtually any size plain paper up to 11" by 17", on transparencies and envelopes.

Now you can be as creative as you want, preparing stunning presentations, graphics, even posters, right in your office. You'll be able to see results and make changes immediately, which saves time and gives you more control.

All these advantages are yours whether you use an IBM® PC or a Macintosh® because the BJC-800 has a parallel interface and the BJC-820 has a SCSI interface.

You'll even be impressed with the cost. Both printers are a lot less than you'd expect, and the cost per page is remarkably low when compared with most other color printers.

Simply call 1 (800) 848-4123, and see how easily you can afford to improve your image.



Canon
COLOR BUBBLE JET PRINTERS
BJC-800/BJC-820

Canon® and BJC® are registered trademarks and Bubble-Jet is a trademark of Canon Inc. Macintosh® is a registered trademark of Apple Computer, Inc. IBM® is a registered trademark of International Business Machines Corp. © 1991 Canon U.S.A., Inc.

Circle 86 on Inquiry Card.



Océ Graphics G5241-PS/4

This printer looks like Darth Vader's telephone with its rounded upper housing. There's a good design reason for that curved top: It holds the ink ribbons, making ribbon replacement easy. After the Seiko ColorPoint PS, this is the lightest printer in the group.

It has the standard I/O ports, but the LocalTalk port uses an ancient DB-9 connector instead of a modern DIN-8. The reason behind this connector choice is that the port also doubles as the serial port. However, if you need access to a LocalTalk network, you're going to have to track down an old-style DB-9 network node to make the connection. The printer has no automatic port-switching; you have to set that up on the front panel.

For scanned images that covered most of a page, the G5241-PS/4 occasionally wrinkled the top portion of the paper. It didn't damage the wax layers, but the wrinkles didn't do much for the page's appearance.



Seiko Instruments ColorPoint PS

The ColorPoint PS has a low-slung design that's marred by a receiving tray that juts out from the base. There are three slot panels at the rear. The bottom slot has a standard parallel port, and this is the basic hardware configuration. The

middle slot is for an optional multiport board with a DB-9 serial, a DIN-8 LocalTalk, and a second parallel port. The top slot holds extra RAM, so you can expand memory from 6 to 22 MB.

Like the HT-500PS, it has an audible alarm signal that can be shut off from the front panel. The LCD panel has decent, informative messages. Flipping up a cover reveals a maze of arrow keys and no fewer than 16 buttons that serve as numeric keypad, function keys, and menu selection. Most of the time, you'll leave the entire setup alone except for using the arrow keys to walk through the printer's configuration menus.



Tektronix Phaser II PXi

Considering the different configurations of the button/LCD panels on the six other printers I tested for this review, it was interesting to see that the Phaser II PXi did not have such a panel. Instead, there are seven LEDs that indicate power, printer ready, error, paper jam, ink ribbon, cover open, and paper out. The ready light blinks as the Phaser II PXi reels in data.

The usual three I/O ports and SCSI connector are located in the back, along with quite a few DIP switches that you would mostly use to force a hardware reset or set the serial-port speed to a fixed 1200 bps. As with the HT-500PS, this back panel comes off so that you can add SIMM RAM.

The Phaser II PXi uses Adobe level 2 PostScript. As the benchmarks show, this printer was clearly the fastest in most categories, with the exception of the Photoshop print and download. Perhaps most important, the printer's output was a winner as well: Tektronix has spent many research dollars on color dithering

technology, and it shows. The dithering of the scanned images and the color wheel are about the best that the BYTE Lab has seen.

Rainbow's End

Color printing has certainly improved in the past several years. Simply put, the output looks a lot better. Scanned images appear less muddy and less flat than those that were produced with older printers. Printing performance has improved, too: Even the slowest printer in this review group produced output several times faster than the now-ancient ColorScript 100.

But there is still room for improvement. The wax-based inks on paper are prone to scratches and flaking, so it's not likely that you'd use these printers to print a color newsletter. Instead, most of these printers will find homes in design shops or in advertising agencies, where their output will be used only to proof the color artwork and other color items that are destined for final printing in books, magazines, and other press-printed material.

Pantone-licensed printers, with the appropriate software, also allow you to fine-tune the colors in your output. This gives you a close approximation of how the final output will look.

In this situation, the frailness of the wax pigments isn't an issue. What's important is that your printer's output allows you to catch glitches or mistakes before you send a file to be printed on a typesetter. Even at 50 cents per page, a thermal-wax-transfer printer reduces costs by keeping expensive errors to a minimum. In addition, these printers are also good for creating overhead transparencies for business presentations.

My runner-up choices are NEC's ColorMate PS Model 40 and CalComp's ColorMaster Plus 6603PS. The ColorMate PS Model 40 did well in the benchmark tests and costs less than the Phaser II PXi. However, its output quality is not up to that of the Phaser II PXi, and its front-panel design is awkward.

The ColorMaster Plus 6603PS has a middle-of-the-road performance and a middle-of-the-road price tag. The machine is built like a tank, and its output quality is better than that of the ColorMate PS Model 40. For those who relish the appearance of their output, the ColorMaster Plus 6603PS is the better choice.

But my personal favorite is Tektronix's Phaser II PXi. It's fast, and the company's dithering algorithms result in less-grainy scanned images and more

All the benefits of a laser printer

A size



- DESKTOP CONVENIENCE
- RELIABILITY
- LOW COST
- SHARP, HIGH QUALITY OUTPUT
- FAST PRINTING SPEED
- PLAIN PAPER

size



On a much larger scale.



\$1499

At last. A personal output device that combines the best features of a desktop laser printer with the ability to produce large format drawings. It's called ProTracer — a 360 dpi desktop printer/plotter that produces A, B, as well as C-size output.

ProTracer's speed and quiet operation come from the latest Canon inkjet technology and an Intel i960 processor. Drawings that take up to half an hour to print on a pen plotter take only five minutes on ProTracer!

And, unlike other large format devices, ProTracer isn't limited to plotting. Start with the ProTracer base unit that incorporates resident IBM ProPrinter and Epson LQ-1050 emulations, as well as an ADI plotter driver for AutoCAD users. Then, depending on your needs, choose from a variety of optional accessories includ-

ing HP-GL® and PostScript® language emulation cards.

Optional Printer Accessories	
HP-GL emulation card	\$399
PostScript language emulation card	\$499
2 MB memory upgrade	\$299
4 MB memory upgrade	\$499
8 MB memory upgrade	\$899
Sheet feeder I (100 sheet)	\$149
Sheet feeder II* (100 sheet)	\$129
PacificTalk (AppleTalk interface module)	\$199
*Sheet feeder I is required for use	

At Pacific Data Products, we're devoted to customer service. We offer a **60-day money back guarantee of satisfaction**, one year and optional extended warranties, and free lifetime technical support. Should you require a replacement unit while under warranty, one will be rushed to you immediately to minimize your downtime.

If you'd like to expand your printing and plotting capabilities, call Pacific Data Products at (619) 597-3200 ext. 2112, Fax (619) 552-0889.

PACIFIC DATA PRODUCTS

Pacific Data Products, Inc., 9125 Rehco Road, San Diego, CA 92121. ProTracer is a trademark of Pacific Data Products, Inc. PostScript is a registered trademark of Adobe Systems, Inc. Canon is a registered trademark of Canon, Inc. All other trade names referenced are the trademarks or registered trademarks of the respective manufacturer. Nozzle image courtesy of AutoDesk Inc. Tiger rendering, artist unknown; picture part of public domain. ProTracer uses the latest in high technology innovation including PeerlessPage™, the advanced Imaging Operating System from Peerless. EUROPEAN OFFICES: Geneva Tel (41) 22 41 26 50, Fax (41) 22 41 06 82, France Tel (33) 1 39 23 20 00, Fax (33) 1 39 63 31 20, U.K. Tel (44) 442 231414, Fax (44) 442 23 65 40 © 1992 Pacific Data Products, Inc.

precisely toned colors in artwork. The front panel is uncluttered and simple, but you have to remember to position the slider to the appropriate medium (i.e., paper or transparency) before printing. It's one of the pricier printers I tested, but its speed and results well justify the additional cost. ■

Editor's note: *Shortly before this article went to press, Tektronix introduced its new Phaser II PXe, a thermal-wax-transfer printer for \$4995. The Phaser II PXe is nearly identical to the Phaser II PXi just reviewed here, but its lower price is achieved by using a 16-MHz AMD 29000 processor. Also, maximum memory is*

limited to 8 MB, and the SCSI port is absent.

Tom Thompson is a BYTE senior technical editor at large. He has a B.S.E.E. from Memphis State University. Contact him on BIX as "tom_thompson" or on AppleLink as "T.THOMPSON."

COMPANY INFORMATION

Brother International Corp.
(HT-500PS)
200 Cottontail Lane
Somerset, NJ 08875
(908) 356-8880 ext. 4300
fax: (908) 469-4415
Circle 1131 on Inquiry Card.

General Parametrics Corp.
(Spectra*Star Model 430)
1250 Ninth St.
Berkeley, CA 94710
(510) 524-3950
fax: (510) 524-9954
Circle 1133 on Inquiry Card.

Océ Graphics USA, Inc.
(G5241-PS/4)
385 Ravendale Dr.
Mountain View, CA 94039
(415) 964-7900
fax: (415) 961-6152
Circle 1135 on Inquiry Card.

Tektronix, Inc.
(Phaser II PXi)
26600 Southwest Pkwy.
Wilsonville, OR 97070
(503) 685-3150
fax: (503) 685-3063
Circle 1137 on Inquiry Card.

CalComp Computer Graphics Group
(ColorMaster Plus 6603PS)
2411 West La Palma Ave.
Anaheim, CA 92801
(714) 821-2000
Circle 1132 on Inquiry Card.

NEC Technologies, Inc.
(ColorMate PS Model 40)
1414 Massachusetts Ave.
Boxborough, MA 01719
(508) 264-8759
fax: (508) 264-8000
Circle 1134 on Inquiry Card.

Seiko Instruments U.S.A., Inc.
(ColorPoint PS)
1144 Ringwood Court
San Jose, CA 95131
(408) 922-5800
fax: (408) 922-5840
Circle 1136 on Inquiry Card.



Even faster and more flexible than before!

ISYS finds the documents you need faster than you ever thought possible.

Locate and use textual data anywhere on your hard disk or network in mere seconds.

"ISYS replaces ZyIndex for DOS as the industry standard for unstructured DOS text retrieval programs." PC Sources 11/91

Usually, the time you want to find information most is when you're in the middle of something. Without exiting your work, pop up ISYS, get what you need, then copy and paste it into whatever you're working on!

"...ISYS is as fast as lightning...cleanly and intuitively designed, which makes it an easy program to use." InfoWorld 9/23/91

"ISYS...offers good search options and a wide range of features for the modest price of \$395." PC Week 5/20/91

"...fast, easy to set up and use, and very powerful" PCM Magazine 12/91
Circle 186 on Inquiry Card (RESELLERS: 187).



**Free Working Demo Disk
1-800-992-4797**

BYTE Free Demo Download
DEMO LINK 617-861-9767*



THE GREAT PRINTER BONUS:

The Kodak Ektaplus 7016 printer gives you a built-in bonus of a convenience copier and, till August 31, it comes with a whole array of other bonuses!



Here's a high-quality 16PPM printer with the incredible convenience of a built-in Kodak copier. No wonder it won a Byte Magazine Award of Merit. Imagine the increase in your work group's productivity with a device that supports both MS DOS and Macintosh computers, simultaneously, through four printer ports. If that isn't enough, plug a fax board into your PC or MAC computer, and the Ektaplus 7016 printer becomes a plain-paper fax machine!

Just for the summer of '92, the Ektaplus 7016 printer comes with an impressive list of bonuses, including a deck of font cards, and supplies—toner and a photoconductor kit—that should last you a year. And, just in case you need an extra incentive to buy now, we'll throw in a \$200 cash rebate. This offer ends August 31, so call now for the name of a dealer near you: 1 800 344-0006, Ext. 4561.

See us at PC Expo Booth 460.

Circle 103 on Inquiry Card.

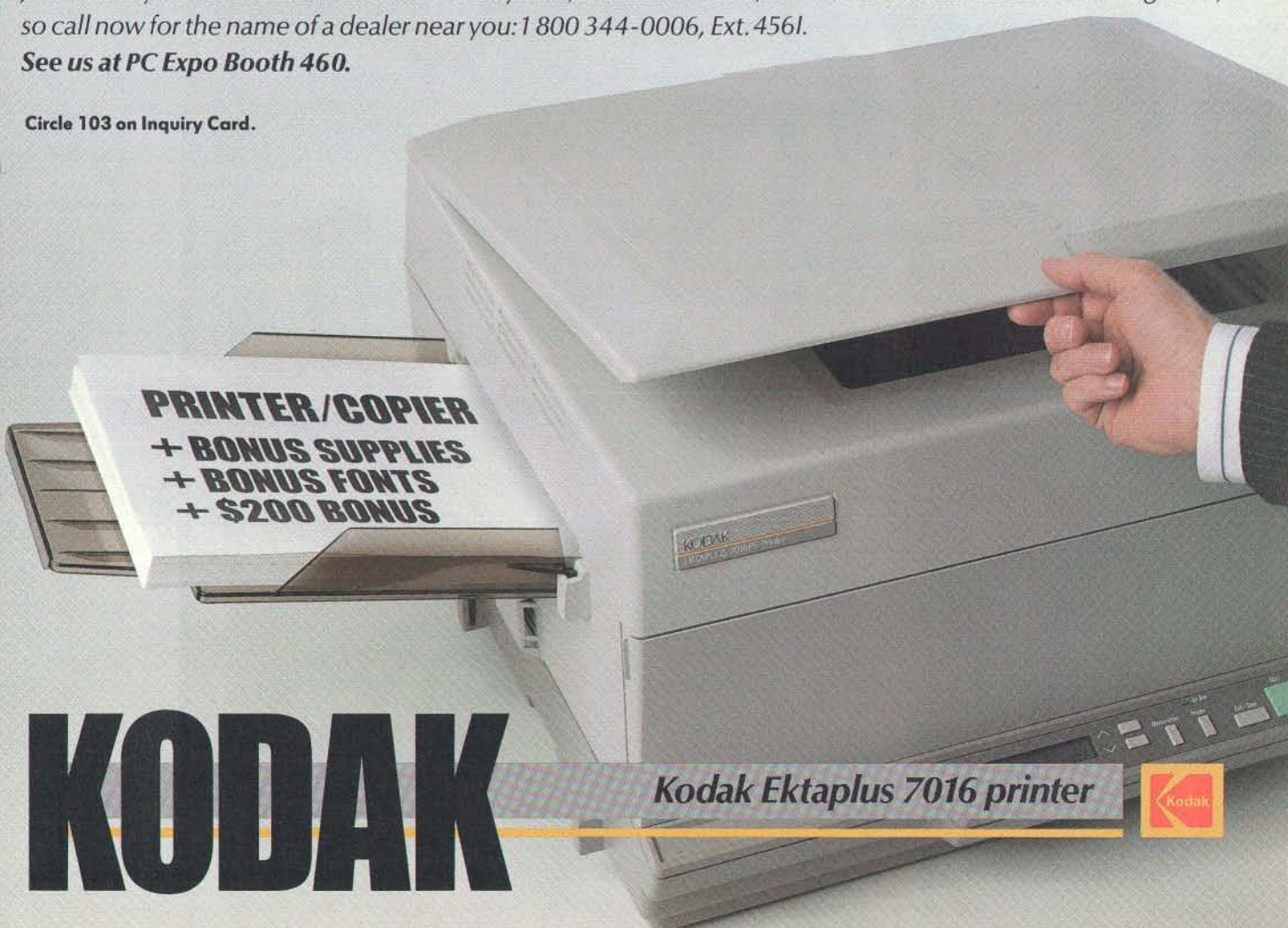

**PRINTER/COPIER
+ BONUS SUPPLIES
+ BONUS FONTS
+ \$200 BONUS**

KODAK

Kodak Ektaplus 7016 printer



WHY SOFTWARE COMPANIES ARE CHOOSING HARDLOCK™



Developers Say...

"Since the Hardlock uses an algorithmic response chip, I am assured of the highest level of protection. Also, the optional programmable memory means I can keep custom configurations in Hardlock rather than in a file. I can protect my .EXE or .COM files directly and/or incorporate Glenco's high level language interface routines into my software. And, I feel confident I'll have Glenco's support if I use other programming languages."

Accountants Say...

"Hardlock provides our company with a healthier bottom line. Since our software can't be copied, our revenue has steadily increased. The unique programming board allows us to program the Hardlock in seconds. This ensures optimum delivery schedules from Glenco and a lower inventory cost for us. Hardlock's field programmable feature means a single Hardlock can protect more than one product."

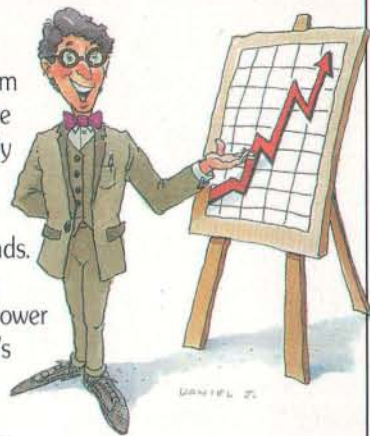

End Users Say...

"Hardlock allows me to backup my software investment. I just plugged Hardlock into the printer card, connected the printer cable, and forgot about it. Since Hardlock doesn't require a battery, I am assured of reliability and no down time."

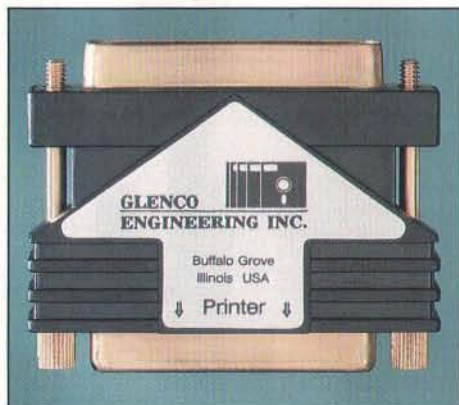

Actual size shown.

Hardlock — programmable, algorithmic response and memory option — all in one

GLENCO ENGINEERING INC.
SERVING THE SOFTWARE INDUSTRY SINCE 1979

270 Lexington Drive
Buffalo Grove, Illinois 60089-6930
(708) 808-0300 FAX 808-0313
1-800-562-2543

HARDLOCK™ The Preferred Protection System!

1-800-562-2543

H A R D L O C K

For a distributor in Europe contact, FAST Electronic GmbH 49-89-539800-20 FAX 49-89-539800-40

For International information circle 106, For End-User information circle 107 on Inquiry Card.

APPLICATION

Looking for Answers? Ask Muse

DON CRABB

Occam Research's Muse is an innovative Macintosh program that combines database and spreadsheet functions with a natural-language query tool. Because it facilitates analysis by making it easier to get through tons of information and find what you're looking for, Muse could help many managers and executives do their jobs faster, cheaper, and better.

Muse is one of the most impressive ad hoc data-analysis tools available today. It combines an internal database engine, data dictionaries, an English-like query system, what-if capabilities, and charting tools. This is an enterprise-wide program that you can use to view and analyze data from different locations. For example, you can tap into a database on a mainframe or an office file server and pull the information into your Mac.

Since Muse is an ad hoc data-analysis tool, you make it do your bidding by asking it questions. In the Script window, which looks something like a sheet of ruled notebook paper, you can type the query "How many copies of Product X did we sell in Europe last year?" On the next line, you get Muse's reply, which is based on information the program extracts from a database. You also use the Script window to define relationships in your data. The Script interface takes about 2 seconds to figure out.

The program's large built-in lexicon helps prevent it from falling into the trap of other natural-language parsing products: not understanding enough English words. Muse can evaluate the declarations or the questions you pose in the Script window by using its lexicon, by searching custom lexicons, by working with its built-in arithmetic functions, or by accessing data in its relational database. I found that it makes few mistakes.

Changing the program's knowledge base is relatively easy. You can add mathematical formulas, Boolean operators, constants, relational operators, and other functions to Muse's lexicon of more than 1000 definitions.

Because it is equipped with its own reference library, Muse can easily handle things such as unit conversions. You could, for example, ask it, "How many

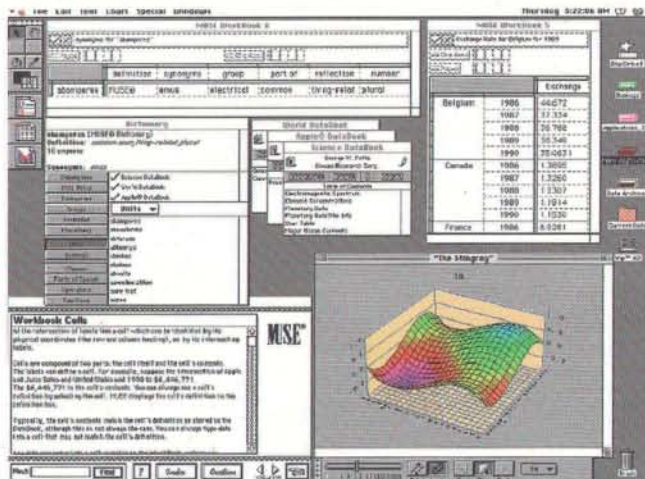

Muse's graphics tools can chart the data you explore in WorkBooks.

kilometers in 500 miles?" Muse already understands things like chemical formulas, the periodic table of elements, physical measurement systems, and other useful data (rather like the big tables you find in an almanac).

Pour Data into DataBooks

Muse stores the data you want to analyze in DataBooks, which are relational databases. These collections of information can sit on a file server, accessible to everyone on the LAN (they can be password-protected). Each one can contain data created within Muse or data from any number of other sources. You can import data from most popular databases and spreadsheets. The program supports common formats, such as DBF, WKS and WK1, SYLK, DIF, ASCII, delimited text, and fixed-field-length text. Each DataBook can hold up to eight dimensions. Muse lets you organize DataBooks of up to 64,000 homogeneous or heterogeneous data structures each.

Muse works with Apple's Data Access Language and with Fairfield Software's Clear Access program, both of which import data from SQL (Structured Query Language) databases into Muse DataBooks. I tested the Clear Access connection using a Sybase database running on a Next server. I was able to import data from the Sybase tables and use it to create DataBooks and WorkBooks. During testing, I also imported DIF, SYLK, and WKS files from other networked Macs and from the Next machine.

Setting up DataBooks will likely be considered a black art by many Musers. I

BYTE ACTION SUMMARY

- **WHAT MUSE IS**
It's a data-analysis package for the Mac that combines some database, spreadsheet, and charting functions with English-language query tools.
- **LIKES**
Query system, what-if capabilities, relational database engine, hooks to mainframe databases, and customization capabilities.
- **DISLIKES**
Limited display of dimensions; difficulty of setting up DataBooks.
- **RECOMMENDATION**
If you have Macs and need to access, query, and analyze data from different sources, buy Muse.
- **PRICE**
\$695
- **FOR MORE INFORMATION**
Occam Research Corp.
42 Pleasant St.
Watertown, MA 02172
(617) 923-3545
fax: (617) 926-3262
AppleLink: OCCAM.HELP
Circle 1228 on Inquiry Card.

recommend that the chore be left to those in an organization who already understand how relational databases are designed. Even though the Muse reference manual makes a valiant effort to demystify the whole thing, Muse DataBooks are as serious as a heart attack and a pain to create.

The Spreadsheet Interface

Muse displays data in a spreadsheet format called a WorkBook. Although WorkBooks serve as data depositories, their primary function centers around analysis. Within a given WorkBook, you can pretty much flop around and evaluate your data any way you like, as if you were in a natural-language spreadsheet. You can fill WorkBooks either with data from a DataBook or with material that you've keyed in directly.

To work on data, you can use formulas or built-in arithmetic transformations. With the what-if tools, you can speculate on the effects of changes. (If, for example, you lower the CEO's compensation rate, what does that do to the bottom line?) You can create whole sections of speculative data, just to see how it plays

Anyone who needs to sift through lots of data will find Muse helpful.

out, and Muse will keep special track of it so it doesn't alter your real data.

The program has a good set of charting and graphing tools (see the screen). As you'd do with a spreadsheet, you select the data you want to graph and then pick your chart type. Muse can draw two- or three-dimensional charts and animated graphs (time-series data can really benefit from that).

Needed: FPU, a Serious Mac

Muse needs an FPU. The program comes in FPU and non-FPU flavors, but I would

not recommend running it without a co-processor. If you expect to do complex graphing, you will fall asleep waiting for the machine to finish the floating-point machinations it must go through using Apple's SANE (Standard Apple Numeric Environment) routines without assistance from an FPU. The difference in my tests on a Mac IIsi (with the Apple Nu-Bus/68882 FPU card alternately installed and removed) showed the considerable improvement the FPU made to complex graphing performance. Graphing was faster by as much as 50 percent with the FPU.

You'll need a serious Mac. While Occam recommends a 68030- or 68040-based Mac with a 40-MB hard drive and 5 MB of RAM, I'd say the minimal configuration to keep you sane would be a Mac IIsi with 16 MB of RAM, a 160-MB hard drive, and an accelerated 24-bit monitor to display those snazzy animated graphs. You can run Muse with System 6.0.5 or higher, but Occam recommends System 7.0. You will also need a network connection so that you can import data from your databases sitting elsewhere or import simpler data (like Lotus 1-2-3



Rub lamp and say:

- "I want vivid color from an affordable printer."
- "I want vivid color from an affordable printer."
- "I want vivid color from an affordable printer."

If that doesn't work call 1-800-835-6100, Dept. 22J.



The Phaser™ II PXe color printer produces 16.7 million of the world's brightest, most vivid colors. It prints at 300 dpi onto transparencies or paper using PostScript Language-Level 2. It works with PC or Mac applications, it's fast, it's networkable and at \$4995, unexpectedly affordable. Rub for awhile, then call.

Tektronix

Circle 163 on Inquiry Card.

WKS files) that's sitting on the office file server.

Quirks

Although others have reported some error-handling flubs with Muse 1.0, I could not duplicate these miscues. Indeed, Muse was a heck of a lot more stable than some of the tried-and-true data-analysis and reporting software I use regularly. Muse does have a couple of internal problems that should be fixed: Leading zeros are not permitted in lexicons, and Muse doesn't store dates as real numbers (so you cannot chart them).

One interface quirk that bothers me is the limit on the WorkBook dimensions that you can display concurrently. Although Muse can show as many as eight dimensions of data, it will show only four at the same time in one WorkBook. Because of this limit, you can't display a WorkBook in which all eight dimensions contain real data vectors on the screen simultaneously. That makes anything more than two-way comparisons tough, since you are navigating through the additional dimensions as if they were pages or chapters of a book. Occam needs to

improve on this display metaphor to make it easier to visualize multidimensional data.

Who Needs Muse?

The most critical issue with Muse is not its prowess but its applicability. Anyone who needs to sift through lots of data—from financials to survey results to baseball statistics—will find Muse helpful. It can be particularly good at examining scientific data (with its graphical orientation and scientific lexicon) and at business forecasting (where the query language will allow exploration of some pretty amazing what-ifs).

The critical implementation issue with Muse is the DataBooks. Corporations will want to build many DataBooks from their SQL tables and other big-iron data and stick these DataBooks down on departmental servers, where Muse users can access them. Frankly, even with decent connectivity tools like Clear Access, if you have to build the DataBooks yourself by importing data from a SQL table or even from more prosaic sources like a dBase DBF file or Lotus WKS file, you'll be much less likely to use Muse as

it's intended. The data-import function, like that in most data-analysis products, will numb you into submission if you aren't careful. Importing can be tedious with Muse because you have to spend a lot of time setting up the import filters. Better let your IS jocks put together some institutionally important set of DataBooks that you can start with.

Muse is not magic. But it does give IS managers some good tools for getting the data from the mainframe to the local Mac server, including its own flat-file data loader as well as SQL hooks, courtesy of Fairfield Software's Clear Access SQL system and Clear Links code. This is a new kind of tool that executives and managers need to explore. If you're using Macs and need to do ad hoc analysis of data from different sources, you should buy Muse. ■

Don Crabb is the director of laboratories and a senior lecturer for the computer science department at the University of Chicago. He is also a BYTE consulting editor and the author of MacWeek Guide to System 7. He can be reached on BIX as "decrabb."

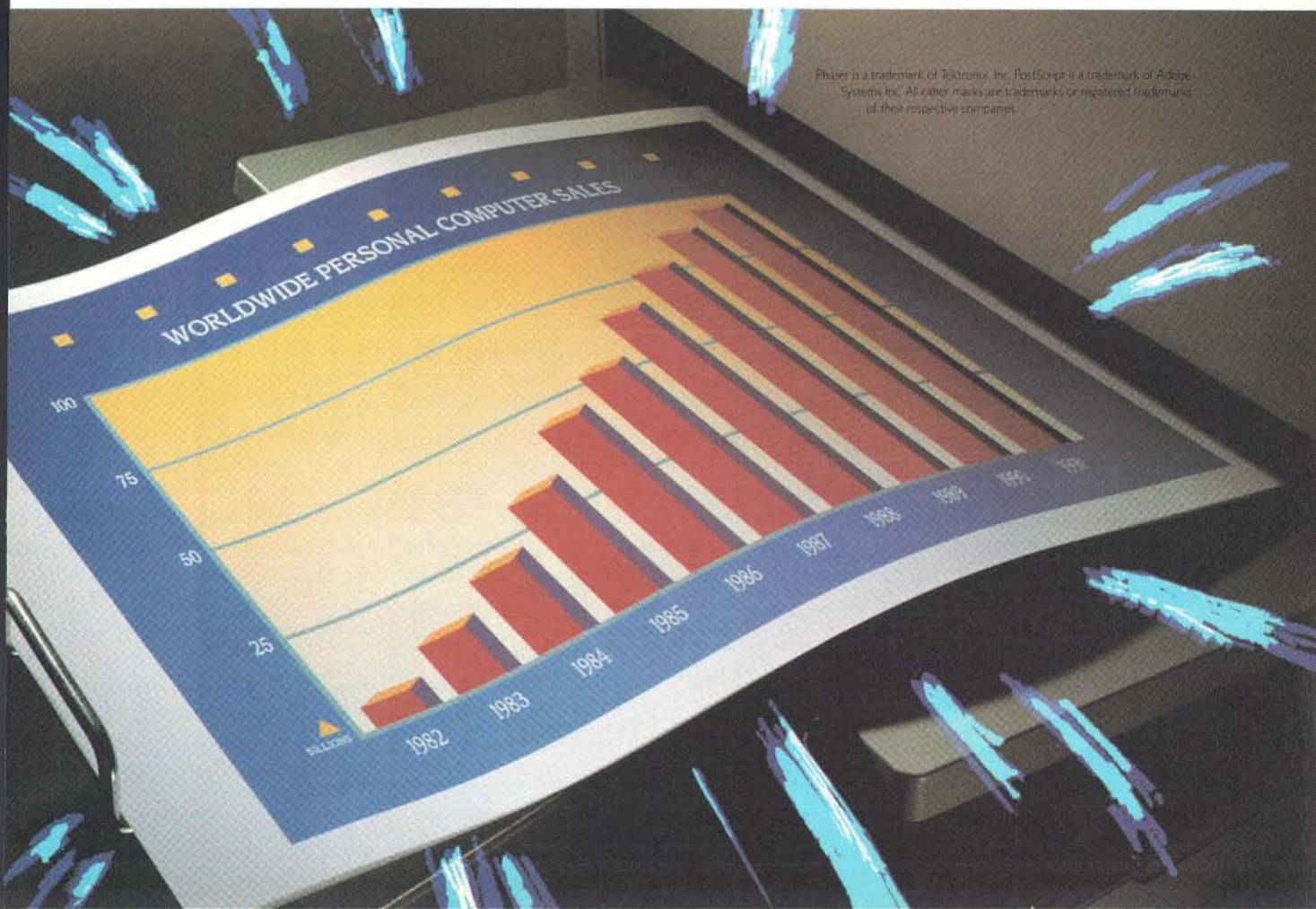

**... I PLEDGE TO MAKE THE EARTH A SECURE AND HOSPITABLE HOME
FOR PRESENT AND FUTURE GENERATIONS "**

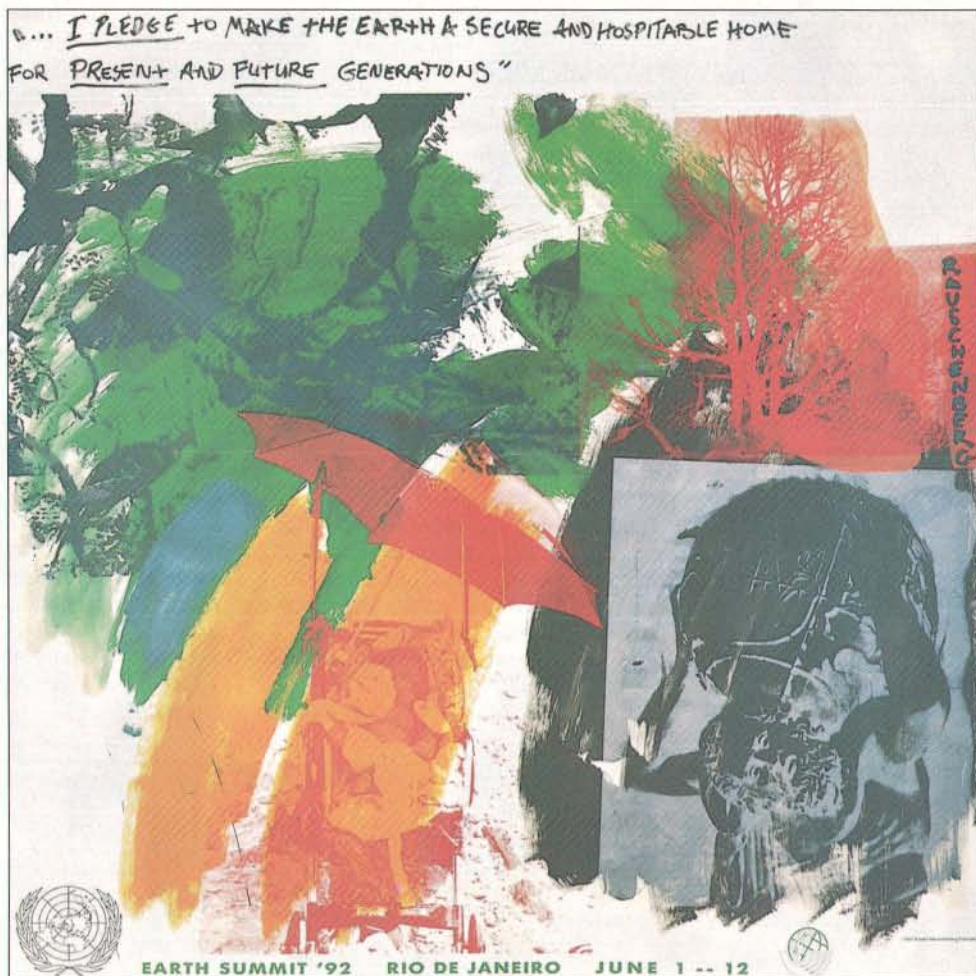

The Earth Pledge poster, entitled "Last Turn, Your Turn", measures 25" X 26" and is printed on recycled 80 lb. cover textured art stock.

LAST DECEMBER, AN URGENT PLEDGE TO SAVE THE PLANET WAS LAUNCHED BY THE EARTH SUMMIT '92 — OFFICIALLY KNOWN AS THE UNITED NATIONS CONFERENCE ON ENVIRONMENT AND DEVELOPMENT (UNCED). THIS UNIVERSAL CALL PRECEDES THE UPCOMING EARTH SUMMIT, WHERE 174 WORLD LEADERS WILL MEET IN RIO DE JANEIRO THIS JUNE TO DISCUSS HOW TO HALT THE MOUNTING DEGRADATION OF THE EARTH'S LAND, SEA AND AIR, AND ADVANCE ECONOMIC GROWTH THROUGH SUSTAINABLE DEVELOPMENT.

The official poster to promote the Earth Pledge has been created by renowned artist Robert Rauschenberg, and donated by the Robert Rauschenberg Foundation. It can be yours for only \$19 if you act quickly by calling the toll-free number below. Soon to be a collector's item, this beautiful expression of support for this important summit will mean so much more when you make it your own. Call 1-800-528-3400 and order

your Earth Summit '92 posters today! Or write the Earth Summit Pledge, specify the number of posters you want with an enclosed check for the appropriate amount (include \$3.00 for shipping and handling per order), and send it with your name and the address to: Ivy Hill Corp., 4800 So. Santa Fe Ave., Los Angeles, California 90058. Attn: Fulfillment Dept. Make check payable to the Earth Summit Pledge. Allow 4-6 weeks for delivery.



Let's all put our hands together.
Take "The Pledge" today.

APPLICATION

Database Publishing with Style

JAMES E. POWELL

Turning database information into a good-looking document can be a tedious, time-consuming task, even with a good report writer. Enter two database publishing programs: Ventura DataBase Publisher (VDP) and PageAhead. Both are Windows programs that let you take gallons of data, funnel it through a desktop publishing package, and generate an attractive report. Both offer features that make converting data into a polished catalog, directory, or price list an easy operation, even for people without programming skills or extensive database experience.

The trouble with standard database report writers, even add-ons such as R&R Relational Report Writer, is that they don't offer the sophisticated formatting and layout tools found in desktop publishers. The trouble with desktop publishers is they don't let you tag specific text—a last name or a title, for example—across a whole document all at once; you have to format or stylize each text string individually. This can be a Herculean task when working with a large database.

Database publishing combines the retrieval features of a database with the typographical power of a desktop publishing package. VDP and PageAhead let you specify which records you want and how they should be sorted. You can set fonts and formatting features and then export the results to a desktop publisher to perform the actual printing.

For example, VDP can publish data stored in DBF (dBase) files or convert data from a flat ASCII, SDF, or CDF file. The program can pour data into Ventura Publisher 2.0 and higher, PageMaker 3.1 and higher, and any version of Interleaf. (A GEM version is also available.) PageAhead 1.1 supports DBF and Oracle files. It prepares data for use with PageMaker 3.x and 4.x; with the latest version, 1.1, it now works with a variety of word processors.

These two programs will save you considerable time and energy when you have updated your database and are ready to generate a new version of the output. They let you reuse layouts and text styles. To create an updated publication, you simply import the updated

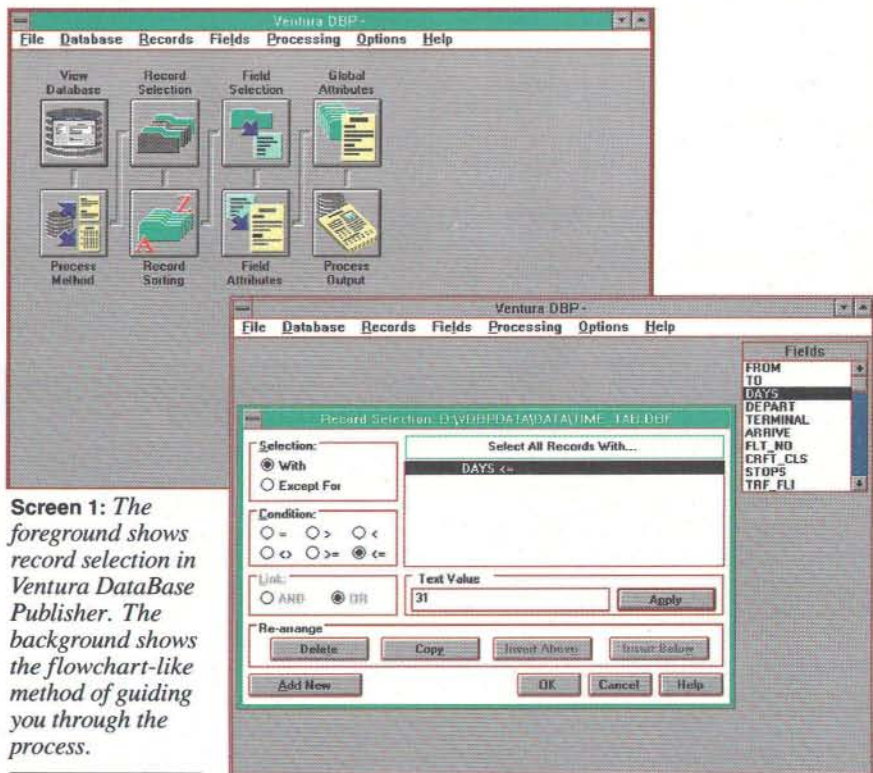

Screen 1: The foreground shows record selection in Ventura DataBase Publisher. The background shows the flowchart-like method of guiding you through the process.

database into your database publishing package; a new edition is ready for printing. If you need different versions of the same document (e.g., a regional directory and a companywide version), you just change the selection criteria from within the database publishing package.

Ventura DataBase Publisher 3.1

Either with a pull-down menu or with icons in a flowchart format (see screen 1), VDP leads you through all the necessary steps of producing a report: selecting and viewing the database, choosing a process method (the publishing software), selecting records, sorting data, selecting fields, assigning field attributes, setting global attributes, and producing the output.

When you select a database, VDP displays a window showing the field names on the left and the values for the first record on the right. You press buttons to move to the first, last, next, and previous records, or you can jump to a specific record using a search value. VDP and PageAhead don't let you change values in the database—you can only view them.

The next step in VDP is to select the

process method. Besides choosing which desktop publisher to use, you can give VDP specific formatting commands: Add tabs after each field to create a quick columnar report or add an em space before each field and a carriage return at the end of each record so text will wrap from line to line, depending on how you set up the desktop publishing program.

Using on-screen push buttons, you then select which records are to be included. You can select records that match or fail to match one or more conditions. You pick the field name from a list box, specify matching conditions in another box, and push radio buttons to select the condition (equal to, less than, and so on).

Sorting records is not complicated: From a list box, you select the field and specify ascending or descending order. You can specify the type of sort, such as ASCII, or use a custom sort table. The custom option lets you specify letters with the same weight; you can use this to let E, e, and ê sort together. You can also specify how to sort numbers: as numerals or as characters. And you can capture a first-letter change, which is useful for personnel or phone directories.

continued

In the next step, you set field attributes. This is where VDP really shines. Here you assign database publishing tags to a field, text to print before or after the field, formatting commands, and whether a field should be used for a heading. You can set single or multiple fields as headings. You can tell the program to print a heading only when it changes or if any field within a multifield heading changes. You can set a field's capitalization rules—capitalizing each word, capitalizing just the first letter in a sentence or phrase, or setting text as uppercase or lowercase.

If your database contains abbreviations or codes, you can specify a dictionary to convert the data when published. This is called a *field substitution dictionary*. For example, if the department field in your database contains a code, such as "45," you can tell VDP to print "Systems Development" instead. You don't touch the original data; you merely convert it when it is published.

VDP also provides word substitutions. Unlike the field substitution dictionary, which works on the entire contents of a field, the word substitution dictionary works on words within fields. For example, you can enter #1.23 in the database and print £1.23. String substitution is

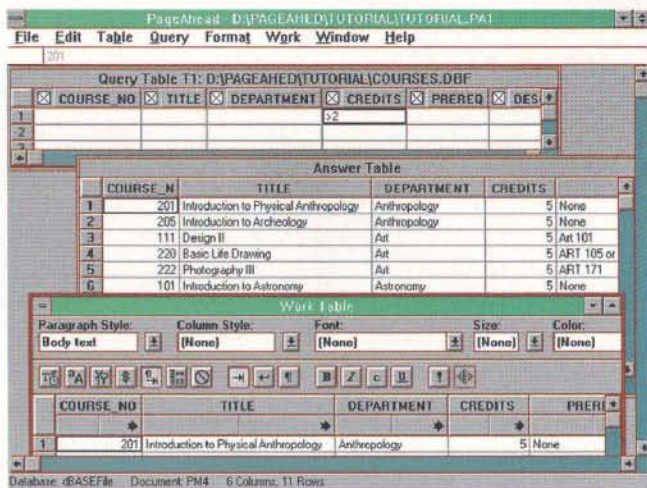

Screen 2: PageAhead uses a spreadsheet-like interface. In the Query Table (top), you select records; the Answer Table (middle) shows you the results; and the Work Table is where you specify text formats and styles.

used with capitalization rules so that McDonald, for example, is not changed to Mcdonald. PageAhead allows the same option, as well as "regular expressions" for more powerful replacement rules. But VDP makes it easier to implement substitutions; it offers you fewer options and has a less confusing interface for this procedure.

Individual field formatting (i.e., type style, fonts, and so on) is tricky. Using a custom keypad on the screen, you click

on the features you want to set. You can control the formatting characteristics each button represents. Unfortunately, with only three characters to work with on each key, the buttons' use may become obtuse: While Bld means bold, Hlb is less obvious (it means hard line break).

When you have finished formatting, you're ready to create the actual output file. VDP creates a text file and a "chapter" file. The .TXT file is displayed in a scrollable window, but it doesn't appear formatted. Rather, you see Ventura Publisher's formatting characters, such as <9> for a tab. PageMaker users will create two files: a .DBP and a .PM4 or .PM3 file (depending on which version of PageMaker you're using). Interleaf users get two .DOC files. Neither VDP nor PageAhead gives you a WYSIWYG preview before pouring the data into the desktop publisher.

PageAhead 1.1

PageAhead offers many of VDP's features but has a unique interface that offers greater visual feedback about the final output. It uses three spreadsheet-like displays: one to show the field names and enter conditions, another to show the result of these conditions, and the last to control the actual display of data (see screen 2).

The first step in the process is to select a database. A Table Information window shows each column (field) name, its type (decimal, character, or date), and data length. Here you use PageAhead's first spreadsheet, called the Query Table. The field names are displayed in the column heading, along with a check box.

Here's an example of how this part of the program works. To select departments less than 100, enter <100 in the first row. You can enter AND conditions

BYTE ACTION SUMMARY

■ **WHAT DATABASE PUBLISHERS DO**

They take raw information from a database, funnel it into a desktop publishing program, and help you turn it into a good-looking report.

■ **LIKES**

Ease of use, ability to stylize text strings across an entire document, and sorting capabilities.

■ **DISLIKES**

Ventura's lack of support for word processors; PageAhead's high learning curve.

■ **RECOMMENDATION**

Although both packages can be recommended, PageAhead excels for its greater publishing capabilities and better use of the Windows environment. Ventura DataBase Publisher well serves Ventura or Interleaf users.

■ **PRICE**

Ventura DataBase Publisher 3.1, \$295
PageAhead 1.1, \$295

■ **FOR MORE INFORMATION**

Ventura Software, Inc.
15175 Innovation Dr.
San Diego, CA 92128
(800) 822-8221
(619) 673-0172
Circle 1229 on Inquiry Card.

PageAhead Software Corp.
2125 Western Ave., Suite 300
Seattle, WA 98121
(800) 967-9671
(206) 441-0340
Circle 1230 on Inquiry Card.

*Frankly Fenton, when I named
you Manager of excess inventory,
this isn't what I had in mind.*

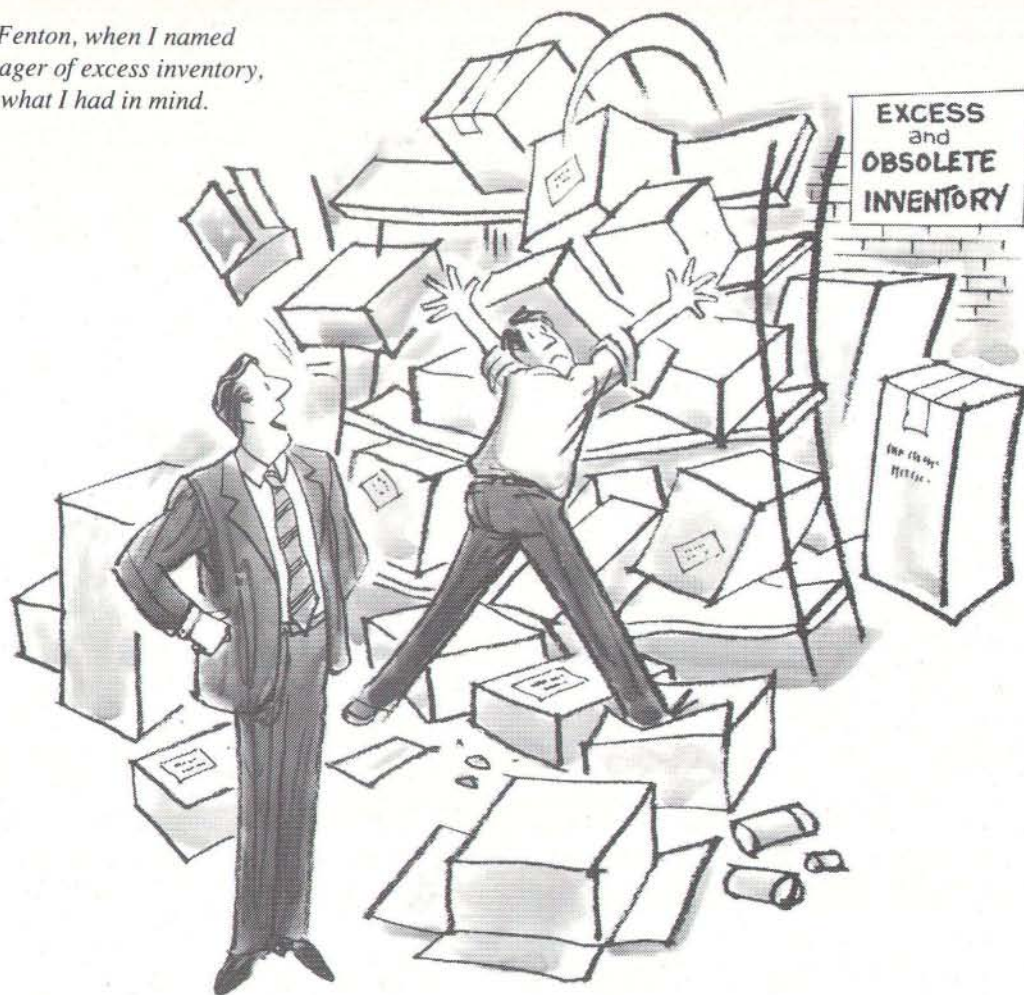

Turn your **excess inventory** into
a substantial tax break and help
send needy **kids to college** as well.

Call for your **free guide** to learn how
donating your slow moving inventory can mean
a generous **TAX WRITE OFF** for your company.

Call **708-690-0010**
Peter Roskam
Executive Director



P.O. Box 3021, Glen Ellyn, IL 60138 FAX (708) 690-0565

Excess inventory today...student opportunity tomorrow

by placing two conditions in the same row, such as >100, <500. More than one condition can be entered in the same row (Sales < 1000, Department > 100) to include records that meet both conditions. If a record meets a condition on either of different rows, it is included. In addition, PageAhead supports the relational operators IS NULL, IS NOT NULL, LIKE, and NOT LIKE (the last two are for pattern matching).

This query-by-example mode is the default. PageAhead offers a mode for entering SQL (Structured Query Language) commands. You may want SQL mode if you are entering SQL extensions specific to a particular DBMS or entering complex entries (e.g., correlated subqueries). You can also view your query-by-example request in SQL mode to see how the translation is handled.

PageAhead allows you to combine information from two or more tables by joining the databases on common columns. Whereas VDP handles a single DBF file, PageAhead allows for relational processing.

When all conditions and check boxes are complete, you ask PageAhead to "query now" and it will give you an Answer Table. This shows the data retrieved by the query. It is for reference only; you can modify the table display but not the data itself. A form view lets you view any row of data in a data-entry form (one field and its value per line).

If the Answer Table shows you the data that you expect, the next step is to add the formatting commands. You do this by opening up the last of the three spreadsheet views, the Work Table.

The Work Table contains the same data in the same initial order as the Answer Table but provides several button bars. Clicking on the style bar gives you a menu of formatting tags, such as paragraph style, column style, font, font size, and color. The button bar contains three groups of buttons that provide shortcuts for layouts and replacements (e.g., capitalization and text substitutions). A set of layout-related buttons displays symbols to determine how data is separated (e.g., tab or new line).

PageAhead makes good use of the Windows environment. It's more graphical than VDP. Within the Work Table you can click and drag columns to rearrange them. You can change column widths by pointing to a boundary line between columns and dragging it until it's the width you want (or you can select a numeric value from a pull-down menu).

To sort data, you select the Sort menu option. A list of available columns is dis-

played. Click on the fields you want to sort on (up to 10), and they fill the "Sorting columns" list box. Pressing the Up or Down buttons allows you to rearrange the order of the sort fields selected.

Besides letting you choose ascending or descending order, PageAhead offers several unique sort options. You can sort a report on a field in the Answer Table or in the Work Table—including fields that do not appear in the report itself. You can also sort on what PageAhead calls "underlying data." For instance, PageAhead displays data as text, even for dates, but it will sort a field based on its actual type. Therefore, a text sort would display April 1 before March 1; when sorting by underlying data, PageAhead sorts the column according to the value in the field, so March 1 appears before April 1.

PageAhead also lets you create a summary, using operators such as MIN, MAX, SUM, COUNT, and AVG. This allows you to select two fields, such as department and annual sales, and generate an Answer Table summarizing sales by department.

When it comes to formatting, PageAhead lets you separate fields by tabs (the traditional approach) or group fields into a paragraph. At the end of each paragraph, PageAhead inserts a hard return. A pop-up window lets you specify text before and after each field, including spacing. If data is not present in the field, the text can be suppressed.

Formatting overrides can change paragraph or column styles when the value is found in a table. When a TERMS field contains "LIMITED OFFER," for example, you can print the text in bold. PageAhead can incorporate graphics in the final output, so a database field containing the filename of the graphical image can be interpreted to display the actual image in the final output.

Like VDP, PageAhead lets you replace data (e.g., "Southern Region" instead of "region 4") for entire fields or for just portions of text. You can delete data, too, so you can keep only an employee's last name in a full-name field. Another replacement option allows you to rearrange data, so that *A Tale of Two Cities* sorts as *Tale of Two Cities, A*.

Like VDP, PageAhead lets you specify capitalization rules and exception tables. A Separator Table stores the characters used to delimit words, and by default it includes characters such as (, {, /, ;, and +.

When you are ready to go to PageMaker, you save the PageAhead file, open PageMaker, and bring in ("place,"

in PageMaker parlance) the tagged database file.

PageAhead 1.1 can prepare files for Windows word processors, too. Specific directions are provided for Microsoft Word for Windows 1.1 and 2.0, WordPerfect 5.1, Ami Pro 2.0, and other word processors supporting RTF (Rich Text Format). It will also work with files for DOS word processors, including Word 5.0 and 5.5, WordPerfect 5.0 and 5.1, and others supporting RTF.

Which One?

VDP and PageAhead let database novices easily specify which records they want to include in a document. Both products are also good for anyone who does not have update access to a database but needs to change the way information is presented in print. You can change the look of the published data without modifying the original data itself.

VDP is easier to use than PageAhead, and its flowchart approach makes it easier for novices to get up and running quickly. VDP's variety of dictionaries and exception tables should be sufficient to modify the output of all but the most demanding reports.

Both programs support PageMaker. VDP also works with Ventura Publisher and Interleaf; PageAhead does not. But PageAhead does support several word processors; VDP does not.

PageAhead has several unique features, including the ability to work with relational databases, gathering data from more than one database. It also sports a stronger feature set—you have more options and control with PageAhead, but the trade-off is a higher learning curve.

If you routinely have to turn raw data into polished reports, you would do well to consider either of these programs. Of the two, I would pick PageAhead. It provides more publishing-type capabilities, makes more use of the Windows environment, and gives more visual feedback about how your document will look. VDP is more suitable for someone who is not a frequent user of desktop publishing or graphics programs and is mostly interested in cranking out a report quickly. Ultimately, your selection will have to depend on which database and desktop publishing packages you prefer. ■

James E. Powell is president of Masterware, Inc., in Seattle. He is author of Designing User Interfaces (Slawson Communications, 1990). You can reach him on BIX c/o "editors," on CompuServe at 70401,3642, or through MCI Mail at 474-8814.

Up to Date. Down to Earth.



UNIX is changing the world of computers, the world of business – quite simply, changing the world. It's revolutionizing office automation. It's required for U.S. government computer contracts. It's the backbone of information strategies worldwide.

That's why you need **UNIXWORLD** – the magazine that keeps you up to date on the rapidly changing world of open systems computing. Each issue brings you the latest product trends and technical advances that can affect your business. The inside story on some of the biggest high-tech companies. Easy-to-understand programming tips and tutorials that can help your company use UNIX to its fullest. And unbiased hardware

and software reviews to help you invest wisely when you buy.

UNIXWORLD's in-depth features go beyond dry technical facts to show how the pieces fit together – to tell you what's important about the advances and strategies that are changing your world. And **UNIXWORLD** consistently offers the freshest, most down-to-earth writing that you'll find in any computer publication.

Subscribe today and receive the next 12 issues of **UNIXWORLD** for just \$18.00 – half the regular newsstand price. Save even more by ordering for two or three years. You can't lose – every subscription to **UNIXWORLD** comes with a no-risk guarantee*.

Subscribe now!
Call toll-free:
1-800-257-9402 ext. 29

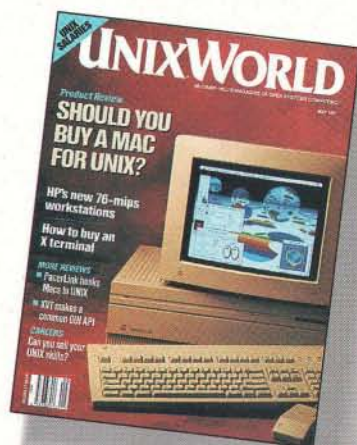

If you're into UNIX, you need

UNIXWORLD
McGraw-Hill's Magazine of OPEN SYSTEMS COMPUTING.

*UNIXWORLD's no-risk guarantee: If not satisfied, cancel and receive a full refund for the balance of your subscription.
UNIX is a registered trademark of UNIX System Laboratories, Inc.

HARDWARE / APPLICATION

Two Tools of the QuickTime Trade

TOM THOMPSON

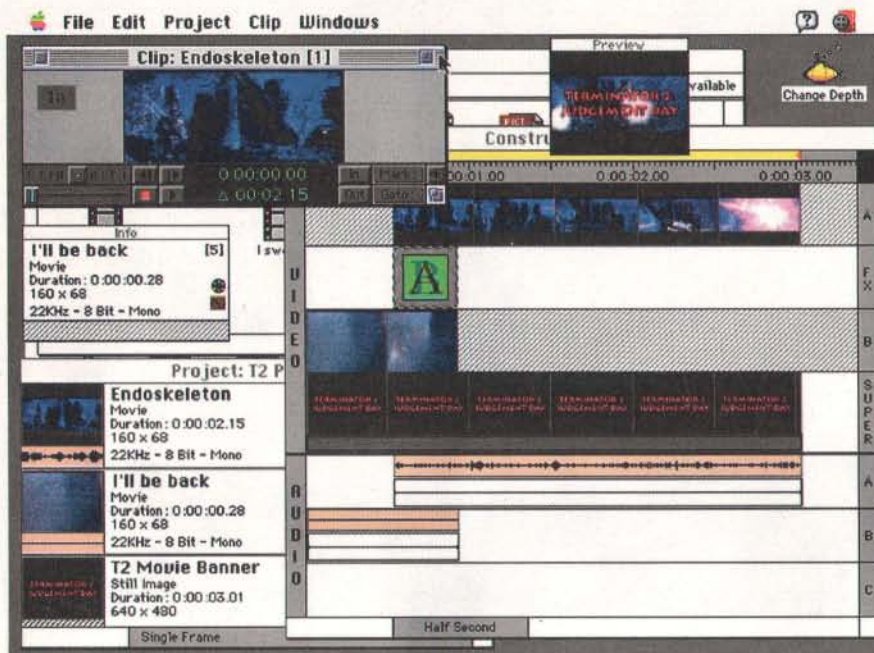

Premiere has been used to consolidate two QuickTime video clips and apply special effects. Clips can be viewed in their own windows (as in the upper left part of the screen). The Project window (lower left) shows clips and information about them. The Construction window (most of the right side) shows a special effect (cross-dissolve) being applied to two video tracks, plus an overlay in the Super track. Sound tracks are at the bottom. The Preview window (upper right) shows the assembled result. (Terminator 2 images courtesy of Carolco/Lightstorm.)

One of the hottest tickets around features SuperMac Technology's VideoSpigot and Adobe Systems' Premiere, which debuted recently as two of the first tools for assembling QuickTime productions on the Macintosh. VideoSpigot is a real-time video digitizer on a NuBus board, and Premiere is movie-making and editing software that lets you combine audio and video.

If you'll recall, Apple's QuickTime gives the Mac OS a protocol for managing time-dependent elements, such as audio and video, and it represents a giant step forward in the integration of multimedia and personal computers. With QuickTime, Mac users can handle moving images combined with sound as they do other information on the Mac: by easily copying and pasting material from one area to another.

But before you can really take advan-

tage of QuickTime, you need QuickTime data, or *movies*. VideoSpigot captures live video into a QuickTime movie format, and Premiere allows you to edit and merge these movies and audio data. These two products are sold separately. During my tests they performed nicely together and had me making QuickTime movies in a relatively short amount of time.

But my experience using both a Quadra and a Mac IICI also tells me there must be Quadras in QuickTime heaven: For performance's sake, you're better off doing QuickTime work with the most powerful Mac you can get.

At press time, other products, such as Diva's VideoShop software, were about to reach the market. Also, a handful of QuickTime applications were available (see the text box "Budget QuickTime Tools" on page 338).

Digital Video and Audio

The VideoSpigot board funnels in live video and audio signals, converts both to a digital format, and then saves this data to disk, all in real time. This is no mean feat considering that it captures and converts a screen of video (called a *frame*) to 24-bit digital data. Furthermore, VideoSpigot continuously processes 30 of these frames per second for NTSC video (or 25 frames per second for PAL, the European standard).

VideoSpigot does this by operating completely in YUV color space. YUV is a standard digital video format in which the frame information is encoded as a composite signal of chrominance and luminance data. This arrangement incurs no overhead or performance penalty because there's no video conversion between the Mac's native RGB space and the YUV format. For live NTSC video, VideoSpigot displays and records frames at fixed sizes from 160 by 120 pixels to 320 by 240 pixels. For PAL, the frame sizes range from 192 by 144 pixels to 388 by 288 pixels. You can record large images at 640 by 480 pixels (NTSC) or 768 by 576 pixels (PAL) from still video.

VideoSpigot's actual capture rate is determined by the frame size, whether audio is being recorded, the host Mac's processing power, and the hard drive's speed. Slower Macs will record video signals at lower frame rates. For example, a Mac IICI will handle about 15 frames per second.

VideoSpigot follows the Mac tradition of easy installation: You pop the hood on the Mac, plug in the board, load the software, and go. The board has an RCA jack for video input; there's no S-video connector. I tried VideoSpigot with two Macs in BYTE's Multimedia Lab. The first was a Quadra 900 with 8 MB of RAM and a 160-MB hard drive. I used the Quadra's built-in video. The second was a Mac IICI with 8 MB of RAM, an 80-MB hard drive, and an Apple 8•24 GC display board. NTSC video came from a Panasonic AG-7750 Super-VHS VCR, a Pioneer videodisc player, or a Canon A-1 digital video camera.

Dealing with audio input on the Quadra was just a matter of plugging a cable into the RCA sound jack on the computer's back and selecting it in the Sound Control Panel. Getting sound into the IICI was a tad more complicated: I had to

route the audio into an old Farallon MacRecorder and copy the MacRecorder Driver 1.0 to the Extensions folder.

VideoSpigot comes with a recording and viewing application called ScreenPlay. Using ScreenPlay to play the video on the Quadra, I got a 160- by 120-pixel window displaying the incoming color video in real time, with the audio blasting from the computer's hefty speaker. On the other hand, the Mac IIci was mute during recording, and the video display dropped frames as the computer struggled to keep up with the incoming data. This is because the ScreenPlay application disables the audio monitor on older Macs to prevent the computer from bogging down. Playing back a captured movie revealed that the audio was recorded in the file. You'll need an external speaker or TV to monitor the audio signal with this setup. The Quadra's own monitor and audio are more than adequate.

The frame-capture rate varies according to the Mac you're using and what you're recording. If you hold down the Option key when you start recording, ScreenPlay stores the frames into memory rather than to disk. This improves the frame-capture rate but limits the recording time to the amount of RAM you have. On the IIci, the frame rate varied from 10 to 15 frames per second, depending on the storage destination (disk or memory) and whether audio was being recorded. On the Quadra, values ranged from about 22 to 30 frames per second.

ScreenPlay provides basic editing tools. You can crop undesired sections out of the frame during the recording process. For example, while recording a letterboxed version of *Terminator 2*, I cropped out the black horizontal strips at the top and bottom of the picture to reduce the file size. Other controls let you adjust hue and saturation of the video. But ScreenPlay provides no way to adjust the brightness or contrast.

After you have recorded a video sequence, a slider bar lets you use the mouse to move about the clip to a general area of interest; two buttons let you step forward or backward a frame at a time to zero in on an exact frame. A pair of In and Out bars lets you trim frames from the beginning or end of a clip. VCR-style buttons let you start and stop recording video data easily. Oddly, ScreenPlay doesn't let you cut or paste clips.

Once you've captured and trimmed a movie clip to your liking, you save the raw data in a VideoSpigot file, or you can compress it, reducing the file size as it's saved in the QuickTime format. The VideoSpigot Extension supplies several compressor/decompressors for this purpose. You select a different bit depth (from black and white to millions of colors), the image quality, and the compression method from a dialog box. You can preview the effects these choices have on the clip before saving it. Currently, VideoSpigot uses Apple compressors, which compress at a ratio of 6 to 1.

By the time you read this, SuperMac expects to be shipping a software upgrade that will yield compression ratios of 20 to 1. Still, the high-quality versions of QuickTime movie files tend to be huge: Several seconds' worth can easily occupy 2 to 5 MB. If you plan to store more than a few short clips, you'll want a hard drive that's both fast (to help with the frame-capture rate) and large.

Adobe's Premier Editing Studio

Once you've captured video clips using VideoSpigot, what do you do with them? This is where Adobe's Premiere application steps in. The program, originally developed by SuperMac, is analogous to an editing studio, where you combine sound and video, along with special effects, to make a complete movie. I was able to combine a variety of sounds, clips, and effects to make movies (see the screen).

You start by importing the various components that you'll need. These can be VideoSpigot clips, other digitizer boards' QuickTime movies, sound files, and PICT images that act as mattes or overlays. The windows containing the clips have sliders and controls so that you can preview them and set In (starting) and Out (ending) points. Premiere uses 32-Bit QuickDraw's GWorld() traps, which provide two major benefits. First, they give you precise color control, especially for dithering a 24- or 16-bit clip down into an 8-bit-deep graphics environment. Second, on those graphics accelerator boards that are equipped with GWorld() RAM, the movie data gets cached on the display board, resulting in faster screen updates and playback.

Next, you load your choices into the Project window, which serves as a data

BYTE ACTION SUMMARY

■ WHAT VIDEOSPIGOT AND PREMIERE ARE

SuperMac's VideoSpigot is a real-time video digitizer board that creates QuickTime movies. Adobe's Premiere is a program for assembling and editing QuickTime movies.

■ LIKES

VideoSpigot and Premiere complement each other as hardware and software components. Both are reasonably priced and easy to use.

■ DISLIKES

VideoSpigot needs brightness and contrast controls, and it doesn't let you cut and paste. Premiere needs Balloon Help to guide the novice; 8-bit audio output could be a limitation for some users.

■ RECOMMENDATIONS

Anyone who wants to use QuickTime for media integration on the Mac, and wants to do it now, should consider this winning combination.

■ PRICE

VideoSpigot: NuBus version, \$599; Mac IIci and LC version, \$499; Premiere, \$495

■ FOR MORE INFORMATION

SuperMac Technology
485 Potrero Ave.
Sunnyvale, CA 94086
(408) 245-2202
fax: (408) 735-7250
Circle 1221 Inquiry Card.

Adobe Systems
1585 Charleston Rd.
P.O. Box 7900
Mountain View, CA 94039
(415) 961-4400
fax: (415) 961-3769
Circle 1222 on Inquiry Card.

Budget QuickTime Tools

You don't have to be George Lucas or Steven Spielberg to produce QuickTime movies. Several low-cost editors and players are available, and more are on the way.

Popcorn, a freeware application from Aladdin Systems, lets you play QuickTime movies and provides rudimentary editing operations, such as trimming sections out of QuickTime movies. Contact Aladdin Systems, Deer Park Center, Suite 23A-171, Aptos, CA 95003, (408) 685-9175.

For those who need to make Mac software product demos or training tapes, there's Spectator. It records Mac screen activity and stores it as a Quick-

Time movie. You can save these movies as stand-alone applications that play themselves, much like self-extracting archives do. Spectator costs \$200 and is available from Rock Ridge Enterprises, 620 Hidden Valley Dr., Suite 102, Ann Arbor, MI 48104, (313) 663-0706.

Also from Rock Ridge Enterprises is VideoBeep, a \$40 product that patches the system beep so, instead of the Mac just beeping, it plays a QuickTime movie. It's a neat hack that undoubtedly consumes lots of CPU clock cycles just to present something on the screen when an alert appears. But it turns your machine into something more entertaining than just a 9-to-5 data bucket.

container for PICT images, movies, and sound clips. Then you drag the desired clips into the Construction window. This window acts as an electronic storyboard where you assemble the final movie. Here you set the time interval when certain clips of video or animation appear, apply special effects, and add or mix sounds. You have two video channels (A and B) to switch between: a track that lets you superimpose an image over the video (Super), and a special-effects channel (FX) that lets you specify what effect to apply to the A and B channels and when. You can lay three sound tracks onto a movie simultaneously, and you have separate controls for each track's volume.

You have to crack the manual to figure out this entire process, but once you understand this sequence of importing, collecting, and assembling various clips into a final movie, you'll be able to produce slick QuickTime movies rapidly.

Premiere does not store clip information in its project files; instead, the project files store pointers to the various clip files on your hard disk. If you delete the clip files from your computer, you lose them in Premiere as well.

While Premiere can import 22-kHz stereo sound files, the current version is capable of outputting only 8-bit 22-kHz monophonic sound. This will be a drawback for people who work on certain types of presentations; digital artists generally agree that 16-bit sound is the minimum for professional-quality audio.

Premiere supplies a bevy of special-effects plug-in modules. You just click on the effects you want and drag them into the Construction window. You can determine when and how long an effect lasts by stretching the icon in the FX track. By double-clicking on the special-effects icon itself, you can modify its attributes. For example, a page-turn effect that simulates turning a page in a book has controls so that you can choose which video track is flipped away to another track, the flip sequence (forward to reveal the scene or backward to hide it), and in which direction (from any of the four corners) the turn begins. Filters let you adjust the brightness and contrast of a clip, invert the image, apply gamma corrections, and more. Premiere accepts and uses plug-ins from Adobe's Photoshop program, and Adobe plans to release information on the special-effects architecture so that third-party vendors can write additional modules.

If you want to preview a movie, you can press the Enter key at any time and then wait a few seconds while the program assembles the elements. When the preview sequence looks good, you then "compile" the Construction window's information into a QuickTime movie. As with ScreenPlay, you can adjust the bit depth of the result, the type of compression to use when saving the movie, and its image quality. You can compile just a section of the movie or the entire contents of the Construction window.

Premiere does its job handily as a QuickTime movie editor. It enhances the value of VideoSpigot by allowing you to correct the brightness and contrast of your clips and assemble the raw material into a finished, polished product. The program does not provide for time codes, so you can't transport rough-cut QuickTime movies to a professional editing system for final polish.

Premiere's one major flaw is its maddening tendency to have essential menu items be dimmed until you click in just the right window or workspace. Implementing System 7.0's Balloon Help, in which the balloons would explain why an item is dimmed (e.g., "You need to pick an object in the Super track to use the Transparency Settings") would eliminate this frustration.

Judgment Day

Who needs these two QuickTime tools? Anyone who must capture data from different sources and edit it into a professional-quality presentation, such as a sales report with animated graphics or a training video. For example, a health-care company might create a document that uses video and audio to teach about electrocardiograms. The video material would show trainees what they might see on a scope in intensive care, while the sound would give them an idea of what they might hear using a stethoscope. The presentation's creator could use VideoSpigot to capture the screen traces and sound and could then turn to Premiere to edit the captured data before pasting it into the final document.

Keep in mind that QuickTime is at the edge of new technology, and that edge is somewhat rough. VideoSpigot and Premiere are very helpful tools, but they are limited by the constraints of QuickTime, particularly in the picture window's size. Don't expect the movies on your Mac screen to look like the movies coming out of your VCR. What's most important about these tools is what they portend.

VideoSpigot and Premiere complement each other perfectly: VideoSpigot hardware creates QuickTime videos that Premiere then lets you put together in useful ways. Both products are practically required for any serious QuickTime work. The possibilities are limited only by your imagination. ■

Tom Thompson is a BYTE senior technical editor at large. He has a B.S.E.E. from Memphis State University and is a certified Macintosh developer. You can reach him on BIX as "tom_thompson" and on AppleLink as "T. Thompson."

SOFTWARE

RLN Spells Long-Distance Ethernet

BARRY NANCE

When you're on the road or working at another site, information back on the office LAN doesn't grow less valuable; you still need access to central databases, mail, and other services. Unfortunately, you can't string a LAN cable between the home office and every remote location. You'll need to rely on telephone lines, and that means relatively slow modem connections.

You've got a few alternatives in connecting to a LAN through asynchronous lines. You can use remote-control software, such as Microcom's Carbon Copy, which shuffles key presses and screen images across the phone line. Or you can use a special LAN remote-control package, such as Novell's NAS (NetWare Access Server), which multitasks several remote sessions in a 386 or 486 PC but remains a remote-control program at its core. Or you can buy a LAN-aware modem, such as the Shiva NetModem-E. This eliminates the smoke and mirrors of remote control by extending local-node status out to the dial-in machine. But such modems support only a few network protocols.

RLN's exhaustive statistics make troubleshooting easy.

Connect	Status	Password	Disconnect	Config*	Remove	Exit
Session status: Connection Closed						
Line Errors:	Framing	Parity	Overrun	Write		
	1	0	0	0		
Protocol Errors:	TCS	Framing	Sequence	Reset	Bad Logins	
	0	0	0	0	0	
Line Status:	DSR	CD	CTS	RI	Baud Rate	
	off	off	off	off	9600	
Traffic count:	Remote Rcv.	LAN Send	LAN Rcv.	Remote Send	Total Comp	
	0	0	0	0	0%	
Ethernet address: 000000000000						
Messages:						
						(Esc) Exit
						(F1) Help

In the end, the solution that comes closest to running an Ethernet cable directly from site to site is RLN (Remote LAN Node), a MAC (media-access-control) bridge from ICC (Intercomputer Communications Corp.). Although its memory usage is high, RLN outperforms remote-control software in many applications without restricting you to a few protocols.

The software turns a dedicated network machine into an RLN server to create the MAC-level bridge between the

local network and the dial-in machines (RLN clients). The RLN client runs all applications on its own processor, with the distant network appearing to be locally connected. File-service packets alone travel across the phone line.

The RLN server is a multiport LAN bridge. RLN can maintain up to 16 concurrent connections with an optional ICC multiport serial board, or two simultaneous connections without additional hardware.

Looking into RLN

The RLN server, a physical Ethernet node with a single Ethernet card, forwards file-request packets from your remote PC to the file server. It acts like a router on behalf of its asynchronous clients, each of which has a unique virtual Ethernet address. Network packets sent over the phone lines are presented on the local network with the (virtual) sender address of the remote client; packets on the network destined for any remote client are plucked off the network and distributed to the appropriate client by the RLN server. RLN does not support network bridging or X.25 links in this release.

Between the remote PC and the RLN server, ICC uses the Point-to-Point Protocol. PPP provides a method for transmitting datagrams over serial point-to-point links. It has three different components: a method for encapsulating datagrams over serial links, an extensible Link Control Protocol, and a family of Network Control Protocols for establishing and configuring different network-

BYTE ACTION SUMMARY

■ WHAT ICC REMOTE LAN NODE DOES

RLN establishes your remote workstation as a node on the network, turning the phone line into a LAN cable.

■ LIKES

RLN's clean approach to remote LAN access eliminates the performance bottlenecks of remote-control packages and the protocol dependence of LAN-aware modems.

■ DISLIKES

Memory usage is high, unless you can manage to shoehorn the protocol stack into upper memory on a 386 machine.

■ RECOMMENDATIONS

RLN is ideal for client/server LAN applications, but it's appropriate for any remote LAN connection with a reasonably powerful client.

■ PRICE

Two-user version, \$430
16-user system, \$6600

■ FOR MORE INFORMATION

Intercomputer Communications Corp.
(ICC)
8230 Montgomery Rd.
Cincinnati, OH 45236
(800) 274-6633
(513) 745-0500
fax: (513) 745-0327

Circle 1223 on Inquiry Card.

layer protocols.

RLN supports a wide variety of network protocols and network operating systems, but only on Ethernet. You can use NDIS, PDS (Packet Driver Specification), or ODI (Open DataLink Interface) drivers that are supplied with RLN to connect to NetWare (IPX/SPX), Unix (TCP/IP), Banyan Vines (SPP/IPC), and either LAN Server or LAN Manager (NETBEUI). Because it is implemented in software, RLN can support additional network protocols with relatively simple software updates.

By default, RLN runs the PDS stack. PDS creates a multiplexed environment for the network adapter that lets multiple protocol stacks share the adapter. The PDS driver that ICC supplies allowed me to load a TCP/IP and a NetWare protocol stack on a remote client RLN computer. Through RLN, I could remotely access both a NetWare file server and a Unix file server at the same time. LAN-aware modems and NAS don't allow this kind of multiprotocol connectivity.

RLN doesn't support Token Ring or ARCnet, but you can, of course, bridge to other topologies on the host LAN. On my NetWare LAN, I put an Ethernet card in the file server alongside a Token Ring card and used NetWare's internal bridging capability to put the RLN server on the network. ICC says that RLN will directly support Token Ring in the future, but the company doesn't plan to support ARCnet.

In the Real World

I put RLN through its paces in two different situations. First, I connected through Intel 14.4EX modems to an RLN server on my combined NetWare 3.11 and LAN Manager 2.1 network (running on SMC Elite16 Ethernet cards). I also got permission from one of my software clients to try RLN at his company's office. The client is a regular user of NAS, and I wanted to see how RLN performed for the client in day-to-day remote dial-up sessions.

RLN's menu-driven installation and well-written documentation made installing RLN easy on my own LAN and at the client site. Configuration is a simple matter of specifying phone numbers, COM port usage, data transfer rate, and other communications parameters. Once RLN was up and running, it did its job transparently and unobtrusively.

The RLN client TSR program takes up 55,872 bytes of RAM—not exactly a trivial requirement—but I was able to load it into high memory with 386Max. This TSR takes you only as far as the

Although RLN is a new product, it shows considerable stability.

MAC layer; you also need the usual protocol stack on top of RLN. If you're accustomed to using IPX/NETX, you'd use RLNIPX and NETX to access a NetWare file server. With ODI, you would use LSL (the link-support-layer driver), PD-ETHER (an Ethernet packet driver module), IPXODI, and NETX. You would load NETBIND and NET START for LAN Manager, BAN.EXE for Banyan Vines, or ETHDRV for FTP Software's PC/TCP. These modules use varying amounts of memory, but they are typical for network drivers. For example, the RLNIPX module uses 28 KB.

Performance depends on the speed of the modems you use with RLN. RLN works with Hayes-compatible modems at speeds of from 1200 bps to 38,400 bps. The data-compressing Intel modems I used ran with an effective throughput of about 32,000 bps. With these modems and with most frequently run executable files (LOGIN.EXE, MAP.EXE, and applications software) running on the client, I found that RLN delivered reasonable response times.

I found similar results on my client's network. For copying files and accessing application data files, RLN was about twice as fast as NAS. It's tricky to try to compare the two, though. An application that does plenty of screen updates will cause more NAS traffic. Conversely, an application that does lots of file I/O will cause more RLN traffic. The performance of NAS and RLN depends on the relative amounts of file I/O and screen activity.

MNP level 5 or V.42bis data-compressing modems help performance in any case. RLN also implements three types of packet-level compression on its own: Tinygram Compression (a part of PPP), which strips trailing zeroes from packets; Header Compression, which reduces encapsulating packet overhead; and an ICC proprietary compression algorithm.

Once you're logged into your LAN, your access to the file server and shared

network printers becomes almost completely transparent. Since your RLN client workstation is just another node on the LAN, you can transfer files with just a DOS COPY command. To do the same thing with remote-control software, you would have to invoke a special file transfer utility.

RLN modifies SYSTEM.INI and WIN.INI files on RLN clients that run Windows. The modified configuration files load drivers that enhance communications performance under Windows. Windows executables, data files, and especially the Windows swap file should reside on your local hard disk. Loading these files across a communications link makes for very sluggish performance.

On my home LAN, I performed a stress test on RLN by disconnecting the telephone wire to simulate a dropped session; RLN promptly notified me that the communications session had abruptly ended. You must reload the protocol-stack TSRs to reconnect, as noted in the documentation. RLN performed reliably and accurately in other tests, as well. Although RLN is a new product, it shows considerable stability.

Statistics and Security

I was impressed by RLN's statistics. RLN displays data traffic totals as well as counts of communication line errors, protocol errors, and bad log-ins. Having statistics like these helps you to solve communications problems when they occur. You can monitor remote sessions at the RLN server computer.

RLN offers three levels of security on top of any security provided by your network operating system. First, an RLN server can check dial-ins against a database of valid user IDs. Second, RLN has dial-back capability. For very sensitive installations, you can use RLN's Remote Security Adapter, a dongle that must be attached to each remote site to allow access.

The bottom line is, RLN works well. For anything more than the most infrequent dial-up to a distant LAN, RLN is a good solution. It offers a clean, protocol-independent approach that paves the way for remote access to client-server applications. ■

Barry Nance, a programmer for the past 20 years and a contributing editor for BYTE, is the author of Using OS/2 2 (Que, 1992), Network Programming in C (Que, 1990), and Introduction to Networking (Que, 1992). He is the editor for the IBM Exchange on BIX, where you can reach him as "barryn."

COPY SOFTWARE ILLEGALLY AND YOU COULD GET THIS HARDWARE ABSOLUTELY FREE.



Software piracy isn't just a crime. It's a shame. Because most people who do it aren't even aware that it's illegal. If you copy software that's protected by copyright, you could lose your job, face a civil suit, pay a \$100,000

fine and possibly be imprisoned. So get the facts now. To request more information, contact the Software Publishers Association at 1-800-388-7478. Because in a court of law, ignorance is one thing you won't be able to plead.

Please send me more information on the legal use of software.

Name _____
Organization _____
Title _____
Address _____
City _____ State _____ Zip _____

Please check software format you prefer if you would like to receive SPAudit, a software inventory management tool:

DOS 3.5" DOS 5.25" Macintosh®

Mail to: Piracy Update, 1730 M Street, N.W.,
Suite 700, Washington, D.C. 20036-4510

H-1

 **Don't Copy That Floppy**

S3 Irons Out Incompatibilities

When we last looked at Windows accelerators based on S3's popular 86C911 chip (see "Tweaking Windows: New Adapters Boost Speed and Clarity," January BYTE), the chip's incompatibilities with the Video Electronics Standards Association's VBE (VESA BIOS Extension) had not been fully addressed by S3 or accelerator-board vendors.

Since January, S3's chip has gained wide acceptance, and noncompliant 86C911 chips are now shipping with accelerators from dozens of vendors. By freeing the CPU from BitBlt, line drawing, font regeneration, and graphical fill functions, the 86C911 can speed some Windows applications from two to 25 times.

However, those of us who also work outside the Windows environment often require a VBE-compliant driver. VBE-dependent applications, such as Animator Pro, simply do not function using an S3-based accelerator in higher 8-bit Super VGA resolutions such as 1024 by 768 pixels. The bottom line: We must run DOS applications at lower 320- by 200-pixel by 8-bit VGA resolutions if we're using an S3-based adapter.

At press time, S3 said that a VBE-compliant version of the chip was in beta testing and would be shipping to OEMs by June. S3's new version is designed to accelerate Windows applications using direct S3 calls and provide full VBE compliance for DOS applications that require higher Super VGA 8-bit resolutions.

How will end users obtain upgrades? Few adapter manufacturers have addressed the issue, in part because the 86C911 chip is hard-wired on most accelerators. However, at least two companies, Diamond and Orchid, now offer upgrades of their own VBE-compliant BIOSes at no charge to customers.

Other manufacturers we spoke with were unaware of the 86C911/VBE non-compliance issue and said they would wait for S3's next chip release rather than supply user upgrades. Still others planned to offer a VBE-compliant S3-TSR DOS driver for their adapters.

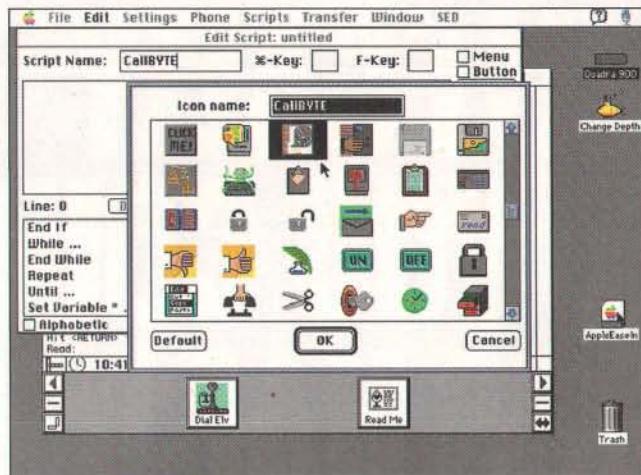

When writing a MicroPhone script, you can associate a telecommunications procedure—dialing the company mainframe, for example—with a push-button icon. The program includes a collection of icons with the script editor.

S3 noted that the VBE standard, at present, makes no provisions for accessing the S3 enhanced graphics functions hard-coded on the 86C911 chip. According to Jake Richter, a VESA director and president of Panacea, the VBE/S3 compliance issue will be examined in a future VESA meeting.

New MicroPhone Plugs into System 7.0

Red Ryder, the telecommunications program for the Macintosh, has been as trusty as an old Shetland pony. But when we were setting up a new Mac recently, it seemed like a good time to switch to a package that knows System 7.0. As luck would have it, the newest version of MicroPhone II showed up. Software Ventures has equipped version 4.0 with the hooks to take advantage of System 7.0's more sophisticated functions.

With Publish/Subscribe, MicroPhone will automatically send downloaded data to any other System 7.0-savvy application. You could have the communications package pour on-line information—stock quotes, for example—right into an Excel worksheet or graph. This isn't something that everyone needs, but if you want a link between an application and some on-line information, this will do it. MicroPhone can also now respond to Apple events, which is a System 7.0

means of passing messages (e.g., Open Application, Print Document, Do Script) between Mac applications.

Scripting is usually a cinch. You can either go into the script editor and pick the commands you need or just tell MicroPhone to "watch me." In this mode, the program records your keystrokes and then compiles them as a script.

For the most part, scripts are portable between Mac and Windows versions of MicroPhone II. We ran into a few snags trying to share scripts between platforms, and a couple of times the program wouldn't put an icon on the button bar (even though it was aware of the script). But other than that, this new version has worked perfectly, with solo

and shared modems.

Easy to learn and easy to use, MicroPhone has always been one of the best programs for communicating outside the Mac. Now, with the System 7.0 capabilities, it's able to communicate within. If you're a MicroPhone user running System 7.0, upgrading to version 4.0 is a no-brainer. If you're running System 7.0 and looking for a new telecommunications package, this is the one. ■

—The BYTE Lab

Reviewer's Notebook provides new information—including version updates, new test data, long-term usage reports, and reader feedback—on products and product categories.

ITEMS DISCUSSED

86C911 GUI accelerator

S3, Inc.
2933 Bunker Hill Lane
Santa Clara, CA 95054
(408) 986-8144
fax: (408) 986-1457
Circle 1226 on Inquiry Card.

MicroPhone II 4.0\$295

Software Ventures Corp.
2907 Claremont Ave.
Berkeley, CA 94705
(510) 644-3232
fax: (510) 848-0885
Circle 1227 on Inquiry Card.



This isn't an ad for a National Geographic[®] Special, an action movie, the



Discovery Channel[®] or Nintendo[®]. It's an ad for the Sound Blaster Multimedia

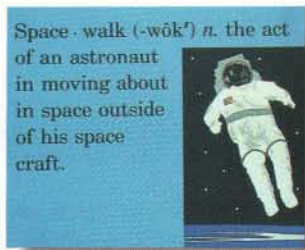

Upgrade Kit. Which turns your computer into all of them.

Over \$2000 worth of goodies for less than \$850.

For more information or the name of your nearest dealer call

1-800-998-LABS

Industry leading 20-channel sound card.

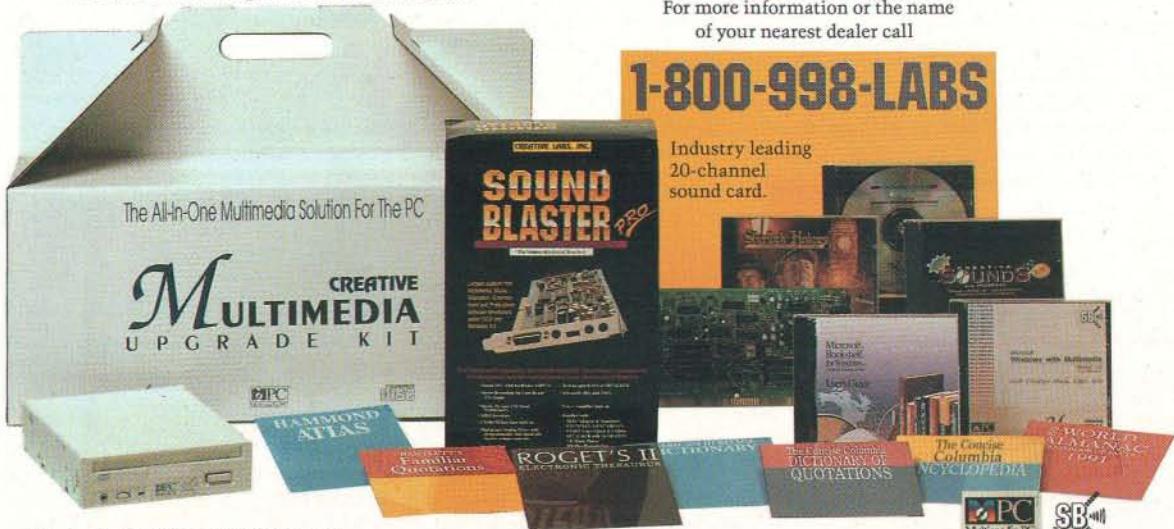

Easy-to-install internal CD-ROM drive.

5 leading CD software titles; including Microsoft Windows with Multimedia Extensions 1.0, Microsoft Bookshelf, Creative Sounds, the Selectware System and Sherlock Holmes, Consulting Detective.

CREATIVE LABS

Outside of North America, call 65-773-0233. fax: 65-773-0353. Sound Blaster is a registered trademark of Creative Labs, Inc. Windows and Bookshelf are registered trademarks of Microsoft Corporation. © 1992 Creative Labs, Inc. All rights reserved.

All trade names referenced are the service mark, trademark, or registered trademark of their respective manufacturer or owner.

Circle 181 on Inquiry Card.

BOOK AND CD-ROM REVIEWS

HUGH KENNER

For at least a little past its first half, Manuel De Landa's *War in the Age of Intelligent Machines* is wholly absorbing once you've forced your eyes to cope with an infinitesimal typeface. He's picked up from chaos theory the notion of singularities—those points at which bland order suddenly changes to a more intricate order called turbulence, which in turn mutates, at the next singularity, back to docile order again. The "sound barrier" that infamously tore airplanes apart is a pre-chaos-theory instance; nowadays, F-15s and Concorde's penetrate it routinely.

For De Landa, singularity is a term heaven-sent to ease the historian's job. History? A list of singularities encountered, followed by innovative ways to beat them.

Suppose, in the age of muzzle-loaders, you want an *accurate* handgun. Those available are essentially portable cannons, needing a hand free to light the fuse. So you support the gun with just the remaining hand. That means it has to be heavy, lest it recoil out of control. To lighten it, we'll need a mechanical igniter; in 1424, the matchlock makes its appearance. It's essentially a way to make trigger pressure shove a burning wick into the powder. Now we have a lighter gun we can guide with both hands, which is a beginning.

Next, ways to get rid of that matchlock altogether: wheel lock, flintlock, percussion cap. Each involves a tracking of singularities. The percussion cap depends on two: the detonation threshold of metallic fulminating salts, which an adequate blow will explode without a spark, and the pressure threshold of the black powder that, once ignited by the fulminate, will drive the bullet. Black powder needs confinement of gases to explode. That made muzzle-loading seem best; breech-loading can't guarantee that no gases will escape toward the rear. That in turn was solved by confining everything toward the rear in a pressure-tight cartridge: the bullet, the right amount of powder, the right fulminate, and the percussion cap.

FIXING DEAD MACS

The Dead Mac Scrolls, Larry Pina, Peachpit Press, 1992, \$32, 484 pp., ISBN 0-940235-25-0.

There's nothing more exasperating than that chilly morning when your car—for no good reason—refuses to start. Running neck to neck with this calamity is the MacFolk's most primal fear: the Mac that won't start. Mug in hand, your morning cheer is rent asunder when you switch the Mac's power on, only to hear a quartet of plaintive notes and see a dark screen. This "death riff" indicates a hardware failure of some sort. Maybe this trouble crept up on you, or maybe you just put in that extra 4 MB of RAM yesterday. In either case, it's time to yank Larry Pina's *The Dead Mac Scrolls* off the shelf.

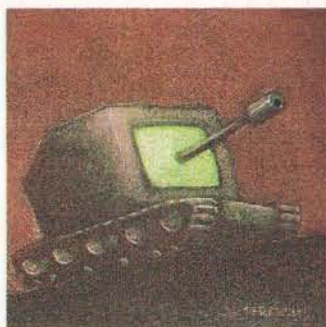

THE IMPORTANCE OF BEING SINGULAR

*War in the Age of
Intelligent Machines*

Manuel De Landa

MIT Press, 1989, \$16.95
(\$32.95 hardcover), 271 pp.
ISBN 0-942299-75-2 (paper).

And now that we're no longer inserting the bullet down the barrel, we can "rifle" the barrel with spiral grooves to exploit a singularity of the moving bullet: Once set spinning at a certain rate, it's stable in flight, especially if we make it cone-shaped. And aha! Now we can *really* take aim! By 1870 (the Franco-Prussian war), everyone on both sides is at last using breech-loaders.

Before the infantry could take reliable aim, their job was simply to make a constant wall of flying lead, groups firing as other groups reloaded. That lent itself to the *clockwork* model of command. Clockwork transmits power, initiates none; from a general sitting at the top, the orders run down clear to the lowliest private. It's like powering a complex of factories from one waterwheel. But power in modern factories is decentralized—an electric motor at every loom—and modern armies rely on subsystems of initiative, right down to Private Jones deciding whom to shoot at. By De Landa's account, the central command has never been altogether comfortable with that. Thus, in the 1950s, enter (under military auspices) the computer, that prime centralizer.

Writing, as he was, in the mid-1980s, De Landa was under the spell of buzzwords now obsolescing: "the Pentagon" and "the military-industrial complex." As early as page 6, he's hinting darkly that "the military," with the CIA and the National Security Agency, has "high stakes" in the game of "controlling the future of computers." By a wonderful irony, his book was closed off just too soon to allow for the newest singularity: the *decentralized* computing of PCs. That helped counter the Soviet Old Guard's insurrection late last year by getting out news that *Pravda* couldn't control. ■

Writing, as he was, in the mid-1980s, De Landa was under the spell of buzzwords now obsolescing: "the Pentagon" and "the military-industrial complex." As early as page 6, he's hinting darkly that "the military," with the CIA and the National Security Agency, has "high stakes" in the game of "controlling the future of computers." By a wonderful irony, his book was closed off just too soon to allow for the newest singularity: the *decentralized* computing of PCs. That helped counter the Soviet Old Guard's insurrection late last year by getting out news that *Pravda* couldn't control. ■

Hugh Kenner is Franklin and Callaway Professor of English at the University of Georgia. He writes for publications ranging from the New York Times to Art & Antiques. His recent books include Mazes and Historical Fictions. He can be contacted on BIX as "hkenner."

The title is accurate: The book deals with dead Macs and contains exhaustive information about all types of hardware failures. Pina breaks down the information by Mac product line and peripheral types, such as laser printers, floppy drives, external hard drives, and monitors. You crack the book to the appropriate section and leaf through it until you find a page that describes your computer's symptoms. Pina describes a possible cause for the failure and gives remedial actions. Some actions, such as checking the cabling and IDs on your SCSI peripherals, adding terminators, or adjusting SCSI cable lengths, you can handle yourself. Other suggestions point out a faulty component that you'd best leave to an experienced technician. Zero in on the problem at the component level, and you can save mucho dinero by telling the technician to replace a single chip rather than an entire board.

The book does have a few minor faults. Corrupt system



**The Most Comprehensive
Pen Event of the Year!**

Pen-Based EXPO

**Los Angeles
September 21-23, 1992**

Chairman's Address

Pen Computing: A New Metaphor for Computing
By Conference Chairman Ed Yourdon, "American Programmer"

Over 50 Technical Presentations Including:

Market Size & Direction

- The Pen-Based Computing Marketplace
- The Pen Market: Success and Growth Factors
- Pen Computing: A Whole New World of Computing - Again!

Hardware Trends

- Putting Pens into the Picture: From Hardware to User Interface
- Handwriting Recognition for Pen Computers
- Pen Products - Which Fit YOUR Needs Best?
- Automated Field Solutions (AFS) through Pen Computing

User/Application Stories

- Developing and Implementing a Pen-Based Application
- Developing Pen Solutions: The Untold Story
- Product Demo "Snapshots"

Software Development

- OS Wars: Microsoft vs. GO
- Developing Pen-Based Solutions
- Spreadsheets: Recreating an Application with Pen

Management Issues

- Evaluating Pen Computer Systems
- Integrating Pen-Based Computing with the Rest of Enterprise Computing
- Pen-Based Computers: Changing the Way People Do Business

Communications Technology

- Survey of Current Pen Technology
- Networking on the GO: Connectivity for the Mobile Professional

**PLUS a Comprehensive Exposition spotlighting over 100
leaders in the Pen developer community.**

Call Julie Adler at (508) 470-3870 for information on exhibiting.

▼
**Featuring
Live
Product Demos**

▼
**Try a
Pen Computer
Yourself!**

Conference Sponsor:



Co-Sponsor:

BYTE

**Call (508) 470-3880
to register or receive
a complete brochure.**

software can mimic a hardware failure at boot-up time, and Pina doesn't point out this "gotcha" anywhere in the book. Also, while the book claims that it's not a repair guide, it still should include warnings about the hazardous voltages present in the compact Macs and in all color monitors.

Nonetheless, the book does teach basic troubleshooting techniques, such as reviewing what you did to the machine last, and what events occurred up to the point of failure. While by no means perfect, *The Dead Mac Scrolls* serves as a first line of inquiry before you hand over your computer to a repair technician.

—Tom Thompson

BUILD YOUR OWN OR UPGRADE?

Build Your Own 386/386SX Compatible and Save a Bundle, Aubrey Pilgrim, Windcrest/McGraw-Hill, 1992, \$18.95, 227 pp., ISBN 0-8306-3750-8.

The Winn L. Rosch PC Upgrade Bible, Winn L. Rosch, Brady Books, 1991, \$26.95, 621 pp., ISBN 0-13-932252-3.

Do you have an old Compaq or IBM AT kicking around that's not doing anything useful? Aubrey Pilgrim's *Build Your Own 386/386SX Compatible and Save a Bundle* and *The Winn L. Rosch PC Upgrade Bible* help you explore your choices.

Pilgrim touches on every aspect of assembling a PC clone from parts or upgrading that old clunker. Most of the book presents an overview of the major components in a 386 PC clone. Pilgrim's recommendations for buying components are sound, and if you choose a standard full-size desktop case, you're in luck.

The book includes excellent photos to take you through assembly and testing. Different case designs and components will fit differently, however, and Pilgrim doesn't offer much help there.

Pilgrim's book makes several excellent upgrade suggestions, not the least of which is to consider finding a good home for your old machine and build a new one. Contrary to the book's title, building your own PC from scratch doesn't always make sense. You can usually buy a mail-order clone for less than the cost of buying all the parts separately. You can, however, pick and choose your components.

Winn L. Rosch's *PC Upgrade Bible* is a comprehensive volume with descriptions of just about every part of your PC and general procedures for making it bigger, faster, and more colorful. Make it through this book, and you'll have a solid background on everything PC, from motherboards to optical drives to mice.

The book doesn't offer step-by-step upgrade photos, but it does include many diagrams. Rosch's best advice comes on page 17: "The best reason for not making an upgrade is that you can often get someone else to do it for you." The store you bought the parts from is likely to install them for next to nothing just to make the sale.

Both books are best suited to computer novices, yet both trivialize the process of selecting and installing an upgrade. Also, neither offers much help when you install that fancy SCSI card and the machine won't boot. Unfortunately, upgrading a PC often requires more than a screwdriver and 10 minutes of your time.

—Howard Eglowstein

HIGH TECH AT YOUR FINGERTIPS



McGraw-Hill Science and Technology Reference Set, \$495.

From "aaa disease" to "ZZ ceti stars," if it concerns science or technology, you'll probably find it in release 2.0 of the McGraw-Hill Science and Technical Reference Set on CD-ROM. The reference set includes every definition from the *McGraw-Hill Dictionary of Scientific and Technical Terms* and a condensed version of the 20-volume *McGraw-Hill Encyclopedia of Science & Technology*. That adds up to 117,000 definitions, 7700 articles, 1700 photos and line drawings, and a rich mix of tables, charts, and diagrams. It's available from the McGraw-Hill Professional Book Group, 11 West 19th St., New York, NY 10011, (800) 262-4729.

The navigational tools let you use the search technique best suited to your needs. You find terms by entering a search query from the keyboard or by expanding and collapsing an alphabetical outline of the CD-ROM's contents. Select a broad topic such as "genetics" and explore any of the entries that fall within it. A new Mirror of the Cosmos graphics screen lets you select topics from a graphical interface. An apple tree represents the biology topic, with each apple labeled with a subcategory such as biochemistry, cell biology, or ecology conservation.

Once you've found a term, you browse through the text, go back to the outline, or select a hypertext link. While reading the entry on stellar evolution, you double-click on a hypertext link to learn more about black holes. From there, you find a link to the theory of relativity. Only highlighted entries support hypertext links, but you can double-click on any term to find its meaning in the dictionary. You click on color-coded references to see illustrations and other graphical aids. You can set a "bookmark" to jump back to an item later, print the article, or copy it to your local hard disk.

The text is clear and accessible, although I did come across stilted prose on occasion. The entry for hallucination, for example, defines the term as "an involuntary sensory experience of objectively nonexistent phenomena," when "seeing things that aren't there" might do.

More disappointing are the graphics, which consist of simple line drawings, black-and-white photographs, and scanned formulas. Although they're informative, they're not visually stimulating. There is, for instance, a telescopic photograph of Jupiter—in black and white. Color graphics and a wider variety of visuals would make the content more appealing.

Nevertheless, I consider the McGraw-Hill Science and Technology Reference Set a fundamental research tool. It places volumes of scientific and technical data at your fingertips.

—Stanford Diehl

HOW SCANNERS WORK



Scanners that enable you to easily incorporate line art, photos, and other graphical images into documents are becoming increasingly popular. The features and capabilities of these once-expensive peripherals have continued to grow with advances in technology, while prices have followed the downward trend that has become the trademark of the computer industry. Indeed, technological advances have been key in improving resolution and overall image quality—of color images in particular. High-volume scanner use in fax machines has also helped advance the technology.

In this article, I'll take a close look at how scanners work and the different ways that technology is being applied to solve technical problems. I'll also look at how scanners interface to personal computers—generally PCs or Macintoshes.

A Brief Background

Around 1987 there was a mass move from simple black-and-white (or *bilevel*) scanners to the more sophisticated gray-scale scanners. Bilevel scanners could scan only line art and similar two-tone drawings. They were unable to generate any true gray-scale output, although many produced a simulated gray scale by reducing their resolution and generating patterns of black dots and white space to simulate gray levels. This process is known as *dithering*.

Gray-scale scanners maintain the maximum resolu-

tion of the earlier bilevel models, but they can assign a gray-level value to each pixel. A gray-scale scanner supports 16, 64, or 256 shades of gray by assigning a 4-, 6-, or 8-bit code to each scanned pixel. Today, these devices represent the biggest share of the scanner market.

Last year was the year of the color scanner. While some color scanners were available before then, 1991 ushered in an era of more choices, a variety of different technologies, and free-falling prices. In the past year and a half, color scanners have achieved important quality and speed improvements and have prices that now make them affordable for many users.

Scanner resolution also improved during this evolutionary period. While the resolution of earlier scanners topped off at 200 to 300 dots per inch, the standard maximum resolution of most modern scanners is now 400 dpi, and some offer up to 800 dpi. With most scanners you can specify the resolution of a scan; 75, 100, 150, 200, 300, and 400 dpi are the common options.

Using a software technique called *interpolation*, many 400-dpi scanners now offer enhanced resolution of up to 800 dpi or even 1600 dpi; this can result in smoother curves and less-jagged diagonal lines in scanned images. Interpolation is accomplished by an "intelligent-guess" algorithm to determine the probable pixel values of those

New techniques make color scanning better and more affordable than ever before

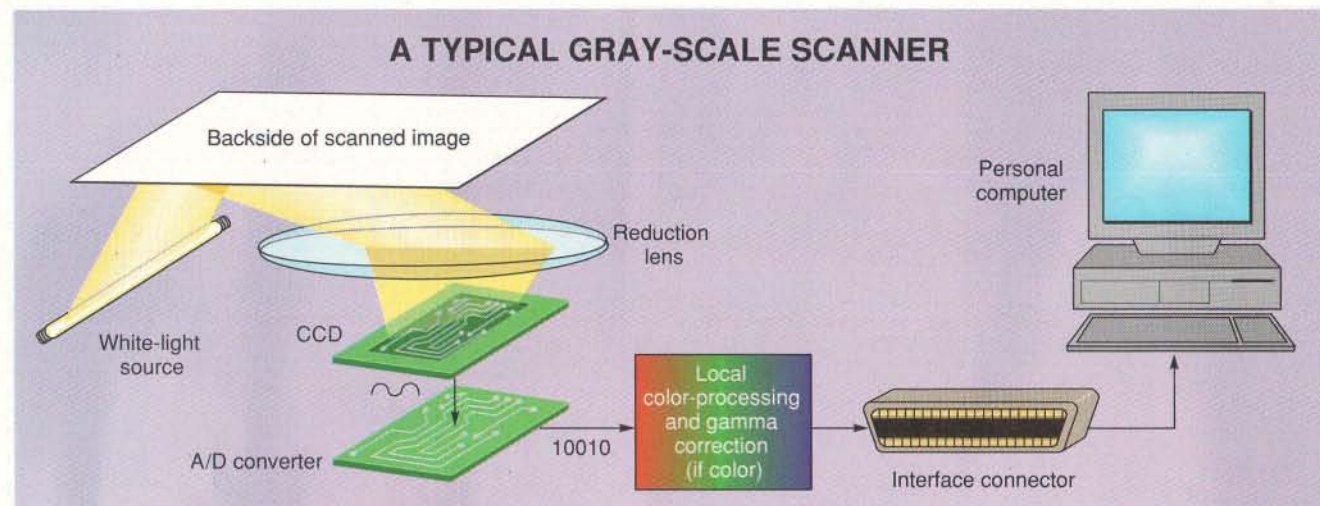

Figure 1: A reduction lens focuses white light reflected from the document onto a CCD (charge-coupled device). The CCD's light sensors output voltages to an A/D converter.

pixels between those that are actually scanned. For example, if one scanned pixel has a gray-level value of 48 and the adjacent scanned pixel has a gray-level value of 76, the software would guess that the unscanned pixel between these scanned ones must have a value of 62 $((48+76)/2)$. Inserting these estimated pixels into the scanned-image file effectively doubles the scan resolution in each direction (x and y), allowing, say, a 400-dpi scanner to generate an 800-dpi scanned-image file. This same technique can be extended for even higher effective resolutions.

Types of Scanners

There are two primary types of scanners: hand-held and desktop. To scan an image with a hand-held scanner, you drag it across the image you want to scan. Typical hand-held scanners use a 4-inch scan width, but some of them reduce their scan width as the scan resolution increases.

Desktop, or page, scanners, of course, generally remain on a desk, and they are capable of scanning an entire 8½- by 11-inch or 8½- by 14-inch page. There are three different flavors of desktop scanners from which to choose: flatbed, sheet-fed, and overhead. Flatbed scanners are the most versatile and generally the most expensive. These units function like a standard office copier: You place the document face-down on a glass plate and then scan it into your computer. This arrangement works for book and magazine pages as well as for single sheets.

Sheet-fed scanners work much like a standard fax machine. Single sheets placed into the top of the scanner are pulled through the unit as the image is scanned. This approach, of course, limits scanning

to single sheets, disallowing books and other bound or thick materials.

An overhead scanner looks like a standard overhead projector, with a flat surface for the document to be scanned and a scanning head above the document. Documents are placed face-up on the scanning surface and are scanned from above by the scanning-head assembly. Overhead scanners generally have a nominal ½-inch depth of field, which means they can scan certain low-profile three-dimensional objects.

The Resolution Dilemma

While they're not limited to this purpose, a common application of scanners is the capture of graphical images for incorporation into documents that are eventually printed on an office laser printer. In an attempt to achieve the highest-quality output, the natural tendency is to scan images at the highest allowable resolution and number of gray scales, or perhaps at the printer's 300-dpi output resolution. But the printed results are often disappointing.

What is not always immediately obvious is that, even at 300 dpi, a laser printer cannot produce the same level of effective resolution as the scanned image. This is because the scanned image has one of, say, 256 gray levels assigned to each pixel, while the laser printer is incapable of producing gray-scale dots; each printed dot is plain black, and unprinted areas are white (or the paper color if colored paper is used).

To achieve perceived grays, the printer must resort to dithering. This is accomplished by grouping dots together to create *gray-scale pixels*. Usually, a 2×2 (four dots), 3×3 (nine dots), or 4×4 (16 dots) matrix of dots will make up a single gray-

scale pixel. The ratio of black dots to white dots in the matrix determines how dark a pixel's gray level is.

It's important to note that the use of dithering reduces the printer's effective output resolution. If a 2×2 dot matrix is used, the number of pixels per inch is reduced from 300 to 150. A 4×4 dot matrix, which allows 17 levels of gray, reduces the output resolution to 75 pixels per inch. To achieve a full 256-gray-level output (using a 16×16 dot matrix), the output resolution is reduced to a barely legible 18.75 pixels per inch. Thus, it may be better to scan an image at a lower resolution and number of gray levels at a faster speed to more closely match the output expectations of the printer. If you adjust the image with a graphics-manipulation program, however, you may need the higher scan resolution to achieve the best results.

There are times when you simply need a higher-resolution scan, such as when you want to print a page on a high-resolution output device, such as a Linotronic printer or typesetting system, or when you have to enlarge a scanned image before you print it. For example, if you scan a 2- by 2-inch graphic at a resolution of 300 dpi with 16 levels of gray, this would exactly match the ability of a standard laser printer to print the graphic as a larger 8- by 8-inch image using four dots per pixel, supporting the 16 levels of gray. The image will be four times larger in each dimension, at one-fourth the resolution. Of course, the new 600-dpi laser printers offer improved output quality for scanned graphics.

The main point here is that resolution isn't everything; you must consider the capabilities of your output device when scanning graphical images. When scanning text

for OCR (optical character recognition) applications, the general rule is, the higher the resolution, the better (although gray scaling is not needed).

Basic Scanner Operation

Figure 1 illustrates how a typical scanner works. The document being scanned is first illuminated by a fluorescent or incandescent light source. The reflected light goes through a lens and onto a photosensor called a CCD (charge-coupled device). The CCD is an IC that contains a row of tightly packed light sensors; the output voltage of each light sensor is proportional to the amount of light striking it.

A single scan line from the document is focused onto the CCD, and the output voltage of each light sensor is converted to a digital value (a binary bit pattern) by an ADC (A/D converter). A bilevel scanner actually uses a simple voltage comparator instead of an ADC and outputs either a black (0) or white (1) level for each light sensor. A gray-scale scanner will output a value that depends on the number of gray levels supported. A scanner that supports 64 gray levels, for example, outputs a 6-bit binary value; thus, the output value will range from black (000000) to white (111111).

The method used to advance to the next scan line varies with the type of scanner. A flatbed scanner moves its scan-head assembly; a sheet-fed scanner automatically moves the page across the scan head; an overhead scanner moves a reflecting mirror in its scan head; and a hand scanner, of course, is advanced when you manually move the scanner across the page.

Once the graphical image is in the computer, it is usually stored on disk in a standard file format—most commonly TIFF. The file can then be processed by graphics manipulation or OCR software as required.

Keep in mind that scanning can use up a lot of disk space. Scanning an 8- by 10-inch 256-gray-level image at 400 dpi, for example, creates a 12.8-MB file. The same image scanned with interpolation to 1600 dpi creates a disk-eating 204.8-MB file, and color images can require three times as much space.

Color-Scanner Technologies

As I mentioned earlier, most of the recent advances in scanner technology involve color-scanner design. As with color printers and color monitors, the design of color scanners is more difficult and involved than that of their monochrome (or gray-scale) counterparts. At least four different approaches currently exist for supporting color on scanners. In addition to the basic scanning operations described here, color

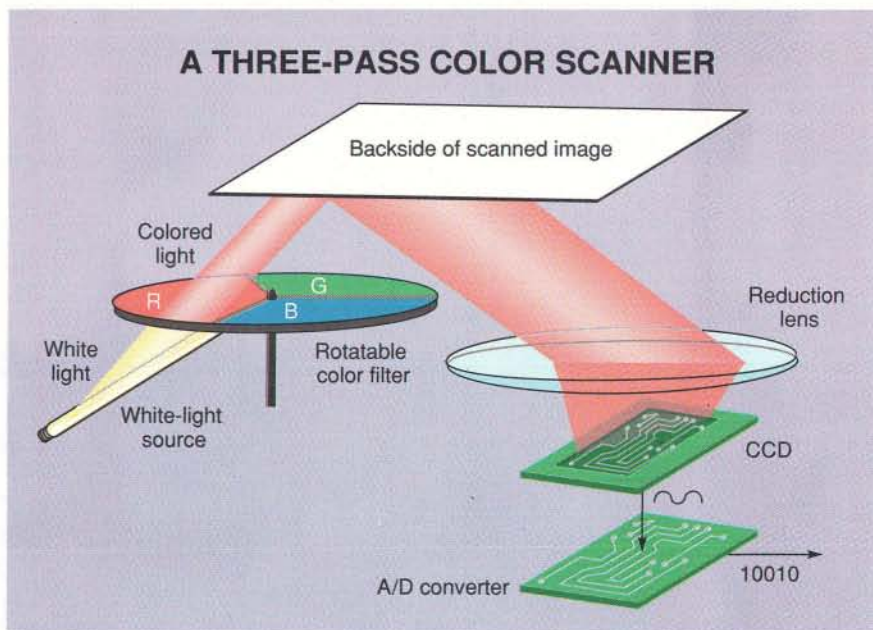

Figure 2: For each scan line, a white-light source shines through red, green, and blue filters.

scanners must also perform local color-processing and gamma-correction operations on the scanned dots before transmitting the information to the computer.

The most basic color-scanner technology is illustrated in figure 2. A white-light source shines through a rotatable RGB filter assembly and onto the document being scanned, effectively creating selectable red-, green-, and blue-light sources. First, the red light shines onto the document, and the reflected light from the document is passed into the lens-CCD-ADC assembly, as in a conventional gray-scale scanner. The process is then repeated with the green and blue lights. Scanners from Microtek take this approach.

The net result of the three passes over the document is a composite RGB color-image file. If the ADC supports 256 levels (8 bits) of gray for each color scan, a standard 24-bit RGB color value is generated to represent each color pixel (for 16.7 million possible colors). If the ADC supports fewer gray levels, the number of bits available for each color pixel is reduced accordingly.

While this approach works reasonably well, it does have two potential drawbacks. First, the fact that three passes are required instead of one generally means the scan time will be much longer than that of a single-pass approach. The second potential drawback is pixel alignment between passes. Before you can obtain a good-quality composite image, all three passes over the document must be precisely aligned. If

even one pass is off by a significant fraction of a pixel, tinting and other discoloration effects can be apparent in the scanned image. Mechanical adjustments are sometimes required to achieve the desired level of calibration.

Three-Light, Single-Pass Color

Another approach to supporting color on a scanner uses three separate light sources: red, green, and blue. The basic concept is the same as for the three-pass color approach described above except that the red, green, and blue lights shine in sequence for each scan line. Thus, the entire color document can be scanned in a single pass, alleviating any concerns of pixel misalignment. Epson and Sharp scanners work this way.

The only potential drawback to this approach is that the different light sources may have different decay characteristics, resulting in inconsistent color results over time. Overall, however, current designs are well implemented and provide a good-quality output in a single pass.

Single-Light, Single-Pass Color

Yet another approach to single-pass color scanning is illustrated in figure 3. A single white-light source shines onto the document, and the reflected light passes through a lens and onto a color-filter assembly. This filter assembly consists of a pair of dichroic filter assemblies that separate the white light into its red, green, and blue components.

continued

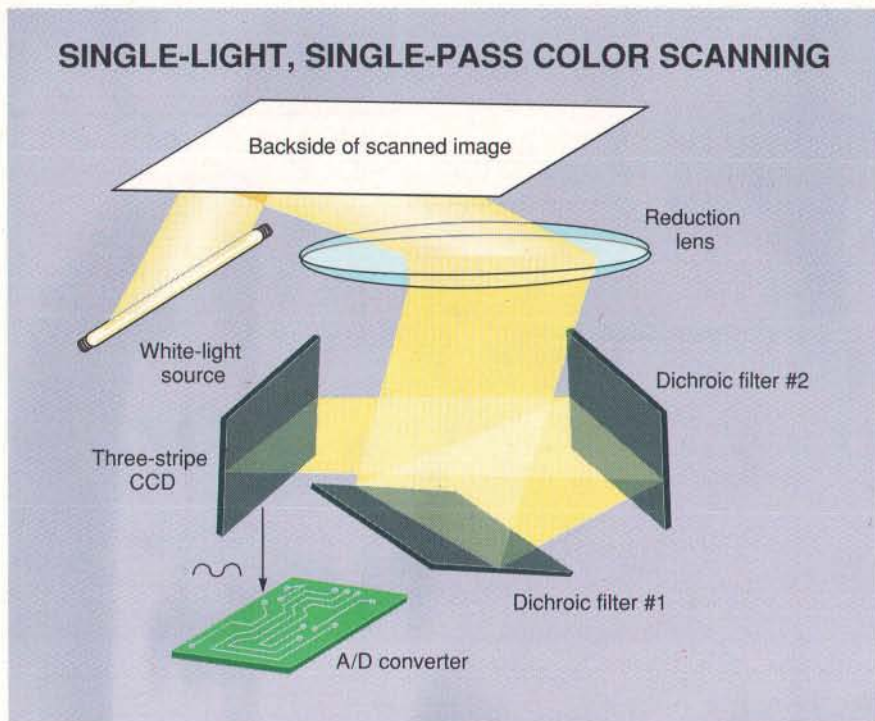

Figure 3: Dichroic filters separate white light into its primary color components. Each separated color shines onto a row of a three-stripe CCD.

The two dichroic filter assemblies each consist of two thin pieces of glass on top of a thick piece of glass. The two assemblies are similar, but they differ slightly. On the first assembly, the top piece of glass reflects blue light and allows red and green light to pass through; the second piece of glass reflects green light and allows the remaining red light to pass through; and the last piece of glass reflects the red light. On the second dichroic filter assembly, the top piece of glass reflects red light and allows the blue and green light to pass through; the second piece of glass reflects green light and allows the remaining blue light to pass through; and the last piece of glass reflects the blue light.

The light from the second dichroic filter assembly shines onto a special three-stripe CCD that has three rows of light sensors (instead of just one, which is the standard configuration). Each light-sensor element in the CCD is about 8 microns (i.e., millionths of a meter) square, and the three rows are each separated by a 200-micron gap. For the document row being scanned, each of the separated colors shines on one of the three CCD stripes, or rows. An ADC then converts the voltage level of each light sensor in each of the three rows into a digital value; the composite 24-bit RGB color value (assuming 8-bit conversions) is then transmitted to the computer.

This approach allows the scanning of

color images in a single pass with a single consistent white-light source and with little chance of pixel-registration problems. The result is good color consistency in a relatively fast single-pass scan. The primary drawback of this approach is the complexity and associated cost of implementation, but recent technological advances patented by Hewlett-Packard have allowed the company to incorporate this design approach in the ScanJet IIC while maintaining competitive pricing. Ricoh uses a similar approach, but its design uses three separate CCDs.

Single-Light, Single-Pass Phototransistor Color

Seiko Instruments recently introduced its SpectraPoint color scanner for the Mac. Deviating from the standard CCD-sensor approach that is universal in the traditional scanner marketplace, Seiko's new offering features patented phototransistor sensors for color-image detection.

A special silicon substrate measuring the full width of the flatbed (8½ inches) contains 10,200 phototransistors, which are configured as three rows of 3400. Red, green, and blue filters are coated on the phototransistors themselves, so each row detects one of the three primary colors. With 3400 sensors in each 8½-inch row, there are 400 sensors per inch, allowing direct 400-dpi color scanning without the

need for the lens-reduction technique used by conventional scanners.

Seiko claims its technology makes the SpectraPoint faster than conventional scanners and permits the scanning of a wider dynamic color range with better color fidelity. The SpectraPoint also has special circuitry that lets you adjust the color output of the scanner in real time to allow color-matching of scanned images to specific color monitors. A PC version is due around the middle of the year.

Scanner Interfaces

A scanner must have some physical link to the computer so it can transfer scanned image information to it. Hand-held scanners typically include a special interface card that plugs into an 8-bit expansion slot. Since almost all these interface boards require the use of interrupts, some are designed to be plugged into either an 8-bit or a 16-bit expansion slot, with the 16-bit slot allowing you to take advantage of the higher interrupts (IRQ10 and higher). Some of these boards also require a DMA channel.

It may take some effort to verify which interrupts and DMA channels are available and which are being used by other devices in your system, but knowing this before installing a scanner interface board and configuring the board accordingly can save you a lot of grief.

A large majority of the other types of scanners use a SCSI connector for connection to the computer. This interface is integral to the Mac and can be installed in a PC as a plug-in card. Many scanners also support a NuBus interface for Macs.

As the typical personal computer user's desktop continues to become increasingly graphics oriented, the number of scanners residing next to desktop computers will continue to increase. The benefits afforded by reliable OCR will have a rising impact on database applications. The popularity of Windows and the recent onslaught of affordable, quality color scanners will give an even bigger boost to the scanner industry, and new advances in scanner technology will continue to improve functionality and push down prices. ■

ACKNOWLEDGMENTS

I would like to thank Steve Ivy and Gerry Meyer of Hewlett-Packard and Rajeev Venkatapuram of Seiko Instruments U.S.A. for their generous assistance during the preparation of this article.

Roger C. Alford, a BYTE consulting editor, is president of Programmable Designs, a Michigan-based electronics design firm. He can be reached on BIX as "rogera."

IT'S A MULTITHREADED WORLD, PART 2

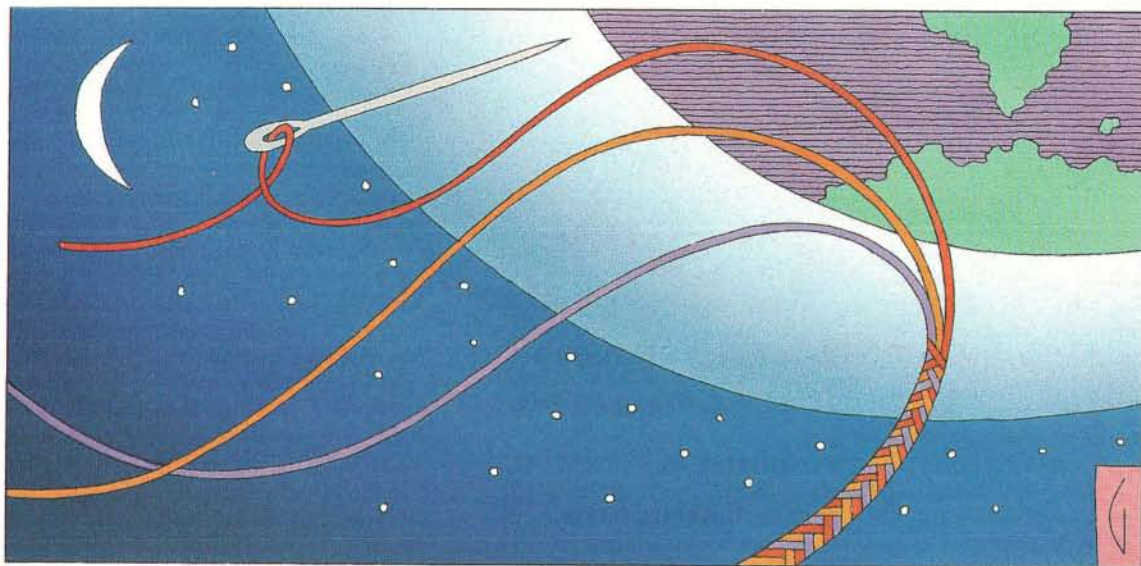

Last month, I discussed the importance of understanding how to program for multithreaded operating systems such as Solaris, Windows NT (New Technology), and OS/2 as MS-DOS begins its slow but inevitable decline. I explored the use of threads and semaphores and introduced ADAM, a dynamic attribute manager that handles the administrative aspects of data modeling. ADAM also illustrates multithreading techniques that simplify application design and speed performance. This month, I'll go into more detail, discuss ADAM's main program listings, and offer ideas on how you can customize ADAM.

Overview of ADAM

The attribute manager administers attributes that describe an object's characteristics. It executes as a separate thread from the application's primary thread and remains idle until the application attaches or detaches an attribute to or from an object. Only then does the attribute manager thread become active and perform the required task.

An attribute consists of a unique name and value. The attribute manager uses the name to locate it. The attribute's value may be predetermined (*intrinsic*), or it may be *derived*. The application knows an intrinsic attribute value; it does not require any event to determine it. Once attached to the object, the intrinsic attribute value does not change. A simple example of an intrinsic attribute is the mathematical equation $\pi = 3.145$.

An event is required to determine the value of a derived

attribute. Derived attribute values can change over time, and they each have an associated attribute procedure. When the application attaches an attribute to an object, the attribute manager spawns a thread to execute the attribute's procedure.

A derived value is a function of its procedure, of time, or of its value. When the value is a function of its procedure, the derived value is the returned value from that procedure. When it's a function of time, it changes over time. When it's a function of its own value, the attribute manager passes the current value to the attribute procedure; the procedure then uses this value to determine a new value. This sounds confusing, but it should fall into place with a few examples.

Consider an attribute, called `IDLE_TIME`, whose value represents a network computer's free time. This attribute can't be intrinsic, since the attribute procedure has to calculate its value to accurately determine how busy (or free) the machine is. Therefore, I need to write a function (call it `CalcIdleTime`) to compute the value. This function is the attribute's procedure. I now know that the attribute name is `IDLE_TIME`; that it is a derived attribute; and that it has an attribute procedure named `CalcIdleTime()`.

Next, I need to know how much time should expire between computations of this value. If the `IDLE_TIME`

Multithreading techniques add speed and simplicity to application designs

Listing 1: Object.h, the generic object format definition.

```
typedef struct _OBJECT {
    void _far *Data;
    ATTRIBUTEVIEW    AttributeView;
    RESOURCE         Resource;
} OBJECT;
```

attribute value has to be recomputed every 30 seconds, how can I write this in a sequential algorithmic approach? I can include a `timer()` that signals the process to recalculate the value every 30 seconds. The disadvantage to this implementation is that the primary thread itself must handle the `timer()` interrupt. This seems harmless, but it affects performance.

The attribute manager lets me define a time period during which the value is acceptable. After this time expires, the attribute manager spawns a new thread to execute the attribute procedure, thus recalculating the value. In this implementation, a separate thread performs the actual computation; the primary thread is not affected. This example also illustrates the concept of software partitioning, in that the algorithm associated with the primary thread remains intact and is not distorted with code to handle the interrupt timer.

Through the attribute manager, an application can attach and detach arbitrary attributes to and from an object. By attaching an attribute to an object, the application has determined that the object has the particular characteristic that attribute represents. The number of attributes that it can attach to an object at any given time is limited only by the number of defined attributes: Each attribute has a unique name, and the application can attach only one instance of a particular attribute to the object at a given time. Note that attributes attach to the object, not to its representative data. From the attribute manager's perspective, there is no relationship between the attribute and the content of the data.

The attribute manager's design lets the user define attributes in addition to those the application defines. User-defined attributes always have an intrinsic value. The user can then attach or detach these newly defined attributes to or from any object within the application. The application's primary thread attaches and detaches attributes, but attribute procedure threads created by the attribute manager determine the values (when necessary).

Design Requirements

Sections of ADAM's design requirements detail source code used in an implementation for OS/2 1.3 using Microsoft C 6.0Ax.

The listings included in this article provide the base for a minimal implementation of the attribute manager. The listings compiled without error and executed on a 386 PC running OS/2 1.3. I've included many hooks for additional functionality and other enhancements that you can add at a later time. I minimized the listings presented

The administration of objects between the various threads requires a common object structure.

here so as not to inundate you with bells and whistles; my intention is to help you understand the basic concepts and functionality. [Editor's note: *Listings in text are abbreviated. An expanded and fully commented version is available in electronic format. See page 5 for details.*]

The attribute manager consists of the `attributeManager()` thread and the `attributeTimer()` thread. Both are invoked when the application's primary thread calls the `attributeManager()` function with parameter `START MANAGERS`. The attribute manager then invokes itself and the attribute timer as separate threads. Upon success, `attributeManager()` returns a zero to the primary thread. At this point, three threads are running: the primary thread, the attribute manager thread, and the attribute timer thread. Regardless of when the application starts the attribute manager and attribute timer, it is responsible for their termination. To terminate the attribute manager, the primary thread calls the `attributeManager()` function with parameter `STOP MANAGERS`.

The administration of objects between

the various threads requires a common object structure. It must include a pointer to the object's representative data, a `RESOURCE` member for change control, and a pointer to the object's `ATTRIBUTE VIEW`.

The object requires a `RESOURCE` for synchronizing access to its information. In particular, if an attribute procedure is to modify the object's representative data, then it must first gain control of the object's semaphore. This prevents a procedure from releasing resources that another procedure is using.

The object's `ATTRIBUTE VIEW` represents the linked list of attached attributes. The attached attributes are members of the object's `ATTRIBUTE VIEW`. Each member of a view always consists of a member data structure containing a pointer to the next and previous members in the view.

In your implementation, you may wish to add two bit-mapped `SETs` to the object—one for the `COMPLETE` attribute set, and the other for the `DERIVED` attribute set. A `SET` is a bit-mapped representation expressing those members belonging to a set. Each attribute has a unique numeric identifier. Therefore, if attribute 154 is attached to an object, the 154th bit in the `COMPLETE` attribute set would be 1; otherwise, it would be 0. This, however, enforces the restriction of an upper boundary on the number of attribute types supported. The `SET` must be able to accommodate all attributes in the application domain and all user-defined attributes.

For performance considerations, the object should maintain two distinct sets: one for the complete set of all attributes attached to the object, and the other for those attributes whose values have been derived. Note that the derived set is a subset of the complete attribute set.

User-defined attributes begin at the next increment from the largest application-domain attribute identifier value. The attribute manager lets the user define additional attributes, provided that it can add the attribute type identifier to the `SET`. The advantage of implementing a `SET` is strictly in the execution time. Using a `SET`, you can apply several simple operations, preventing the need to traverse the entire attribute list associated with an object.

The common object data structure appears in the object header file in listing 1. You can implement a simple routine to create a basic object to allocate the memory for the object structure and perform some basic initializations, such as setting the default values to `NULL`.

Designing the Attribute Manager

The attribute manager evaluates attributes that the application attaches to an object. It

Listing 2: A partial listing of attr.h, the attribute type definitions.

```

#ifndef TOOLS
# include "tools.h"
#endif

#define START_MANAGERS 0
#define RUN_MANAGERS 1
#define STOP_MANAGERS 2
#define MAXATTR 15

DEFINE_VIEW( ATTRIBUTE );
DEFINE_MEMBER( ATTRIBUTE );

typedef enum {
    PROCEDURE, TIME, VALUE, NA,
} FUNC_OF;

typedef union {
    unsigned int Integer;
    unsigned long Long;
    unsigned char Character;
    void _far *Pointer;
} ATTR_VALUES;

typedef struct {
    FUNC_OF FunctionOf;
    unsigned long Period;
    signed short Tid;
    signed long NextRecalc;
    ATTR_VALUES (*AttachProcedure) ();
    ATTR_VALUES (*DetachProcedure) ();
} DERIVED;

typedef struct {
    enum {
        INTRINSIC, DERIVE
    } ValueType;

    enum {
        COMPUTE, COMPUTING, COMPUTED,
        INCOMPLETE, INVALID, TMOUT
    } Mode;
} ATTR_MODEL;

typedef struct ATTRBASE {
    unsigned long Id;
    ATTR_VALUES Value;
    ATTR_MODEL Model;
    CONSTRAINTS Constraint;
    DERIVED Derived;
} ATTRBASE;

/*-----
ATTRIBUTE Type Definition

Configuration: The basic attribute
information.
Resource: A resource type definition to
control updates to this
attribute.
OwnerObject: A pointer to the object for
which this attribute is
attached.
AttributeMember: A member of the view for all
attributes with this same Id.
DerivedMember: A member of the view of all
attributes whose values are
derived.
ComputeMember: A member of the view of all
attributes whose values must
still be computed.
ComputedMember: A member of the view of all
attributes whose values have
already been computed and are

```

```

available to the application.
ObjectMember: A member of the view for all
attributes attached to the
given object.

-----*/
typedef struct ATTRIBUTE {
    ATTRBASE Configuration;
    RESOURCE Resource;
    struct OBJECT *OwnerObject;
    ATTRIBUTEMEMBER AttributeMember;
    ATTRIBUTEMEMBER DerivedMember;
    ATTRIBUTEMEMBER ComputeMember;
    ATTRIBUTEMEMBER ComputedMember;
    ATTRIBUTEMEMBER ObjectMember;
} ATTRIBUTE;

typedef struct ATTENTRY {
    ATTRBASE DefaultAttribute;
} ATTENTRY;

/*-----
ATTRIBUTE TABLE Type Definition
The attribute table is the base of the default
attribute information. This includes the
following:
ComputeView: The view of all attributes whose
values are computed.
ComputedView: The view of all attributes whose
values must be computed.
DerivedView: The view of all attributes whose
values are derived by some
function.
ConstraintView: The view of all attributes
whose values are under some
constraint.
EntryCount: The number of attributes
maintained in this table.
Entries: An array of attribute entry
descriptions.
-----*/
typedef struct ATTRTBL {
    ATTRIBUTEVIEW ComputeView;
    ATTRIBUTEVIEW ComputedView;
    ATTRIBUTEVIEW DerivedView;
    ATTRIBUTEVIEW ConstraintView;
    unsigned long EntryCount;
    ATTENTRY Entries[MAXATTR];
} ATTRTBL;

    unsigned short
attachAttribute(OBJECT *Object, unsigned
short Id, ATTR_VALUES *Values);

    unsigned short
attributeManager(unsigned short Phase);

    void
attributeTimer(void);

    unsigned short
detachAttribute(OBJECT *Object, unsigned
short Id);

    ATTR_VALUES *
getAttributeValue(OBJECT *Object, unsigned
short Id);

END

```

executes as a separate thread invoked by the application's primary thread. The manager synchronizes updates to the object's resources, when appropriate, by requesting exclusive use of the object's change-control semaphore. This thread terminates when the application's primary thread calls the `attributeManager()` function with parameter `STOP MANAGERS`.

The attribute manager requires the `attr.h` header file shown in listing 2. This listing contains numerous type definitions that describe the components of an attribute. While these can be consolidated into only a few type definitions, I chose the more detailed approach for readability. Each type definition includes detailed commentary describing the components of the type and the overall use for it.

Note the definition for `ATTR_VALUES`, which is a union representing all the possible types of attribute values for this implementation. When implementing this on your machine, be sure to change the `ATTR_VALUES` to include any new definitions that your application requires. All attribute procedures return type `ATTR_VALUES`, which is then assigned as the attribute's value.

The `DERIVED` type definition details the information required to support derived attributes. This includes the period and the name for the attribute procedure, which computes the attribute's value. When the attribute manager invokes this procedure, `Tid` contains the attribute procedure's thread identification number. The `getAttributeValue` function uses `Tid` to boost the thread's priority when the application needs a value that's not yet available. Retaining `Tid` with the attribute also lets the attribute manager suspend the thread when necessary. `Period` details the amount of time that can expire before the program has to recompute the attribute's value. `NextRecalc` contains the time after which the attribute timer must recompute the value.

The attribute model is a type definition containing the enumerated `ValueType` and `Mode` members. `ValueType` indicates whether the attribute is `INTRINSIC` or `DERIVED`. Remember that an `INTRINSIC` attribute value is defined on creation of the attribute as either a default predefined value or a value passed to the `attachAttribute()` function. An attribute's procedure computes its `DERIVED` value. The procedure may recompute its `DERIVED` value periodically if the attribute has a defined time period. `Mode` is an enumerated type representing the currency of the value; that is, it represents when the value is available to the application.

The `ATTRBASE` type definition defines

the minimum information required for an attribute. Separating this from the additional administrative information needed for an attribute makes it easier to initialize the attribute in the `attachAttribute()` function. This function can use the size of an `ATTRBASE` type in a single `memcpy()` to initialize the static attribute definition instead of assigning one field at a time.

The attribute manager maintains four views as part of the attribute table.

This minimum information includes the attribute's `Id`, given as a unique identifier for the attribute type.

The implementation could use character strings to identify the various attributes, but this would lead to poor performance as a result of numerous string comparisons. Using a numeric representation for the type permits a simple implementation of set theory to express the attributes attached to a given object. For this implementation, I use an unsigned short for the attribute `Id`, providing a reasonable number of available attribute type definitions.

The `ATTRIBUTE` type definition itself contains an attribute base, a resource, and several administrative members. The attribute manager uses the resource for exclusive rights to update the attribute. A thread requires ownership of the attribute's resource to modify its value or perform administration on the attribute. In general, any modification of the attribute requires ownership of its resource.

The `ATTRIBUTE`'s `OwnerObject` is a pointer to the object to which this attribute is attached. The attribute manager uses this for administrative purposes.

`ObjectMember` is a data structure containing a pointer to the next attribute attached to this object. It also maintains a pointer to the previous attribute in the list of attached attributes. This list is maintained from the object's perspective, representing those attributes currently attached.

The `AttributeMember` linked list also contains a pointer to the next instance of an attribute with this same `Id` (attribute type)

and contains a pointer to the previous instance of this typed attribute. However, it is maintained from the attribute manager's perspective, not the object's. The attribute manager must locate all instances of the same typed attribute and maintain the `AttributeMember` list for performance reasons. Be careful not to confuse it with the `ObjectMember` linked list.

The last type definition introduced in listing 2, `ATTR_TBL`, is the basic definition for the attribute table entries, which the attribute manager maintains. For each attribute type defined, the attribute table's `Entries` array holds one entry, and the attribute `Id` gives the row index. For clarity, the attribute table as implemented here includes all the information for a generic prototype attribute. The entry also contains the pointer to the attribute procedure.

The attribute manager maintains four views as part of the attribute table. `ComputeView` shows all attributes whose values require computing. `ComputedView` is for all attributes with computed values. `DerivedView` shows all attributes whose values are periodically derived. `ConstraintView` contains all attributes whose values are under a constraint.

The `attachAttribute()` function attaches new attributes to an object. The main thread calls it and passes a pointer to an object, the identifier of the attribute to be attached, and an initial value (if the attribute model is `INTRINSIC`). The initial value may be `NULL`, in which case the `attachAttribute()` function uses the default value from the attribute table. After validating the parameters, the function must allocate memory for the new attribute instance and initialize it using the default values from the attribute table. The function must add this new attribute instance to the object's view of attached attributes.

The `attachAttribute` function sets an intrinsic attribute's mode to `COMPUTED`, since no additional work is required to determine the attribute's value. It then adds the attribute to the attribute table's `ComputedView`.

The attribute manager handles a derived attribute a little differently. If you specify a time period for the attribute value, then the `attachAttribute` function adds the attribute to the attribute table's `DerivedView`. It must also add this attribute to the attribute table's `ComputeView` to ensure that the attribute manager computes the value at least one time. The `attachAttribute` function then sets the attribute's mode to `COMPUTE`.

The `attributeManager()` function performs one of three distinct tasks, or phases, depending on the value of the parameter passed to it. During the `START`

MANAGERS phase, the function starts the `attributeManager()` as a separate thread with the `RUN_MANAGERS` parameter. Also during this phase, the `attributeManager` function starts the `attributeTimer()` as a separate thread. On completion of this phase, three threads are ready for execution: the application's primary thread, `attributeManager()`, and `attributeTimer()`.

To terminate the attribute manager, the application calls it with `STOP_MANAGERS`. This sets the `RunManagers` variable to `FALSE`. The `attributeManager()` and `attributeTimer()` threads then fail the `while(RunManagers==TRUE)` test and terminate.

During the `RUN_MANAGERS` phase, the attribute manager spends its time examining the view of all attributes with mode `COMPUTE`. The attribute manager knows that it must compute the value of every attribute that is a member of this view. To do so, it must first remove the attribute from `ComputeView` and set its mode to `COMPUTING`. It locks the attribute's resource to show that it is changing the value and then begins another thread to execute the `attributeProcedure()` function.

This function, running as a separate thread, calls the attribute's defined procedure and assigns the returned value to the attribute. The function then sets the attribute's mode to `COMPUTED` and adds the attribute to the view of all computed attributes. Finally, it unlocks the attribute's resource and terminates the `attributeProcedure`'s thread.

The application calls the `getAttributeValue()` function, which examines the value of a given attribute. By examining the view of all attributes attached to a given object, it can easily find the attribute in question. You should, however, be ready to address a few issues. Specifically, what happens when the thread to compute a derived attribute value has not been started or is still running?

The `getAttributeValue()` function tries to lock the attribute. If it can't, it assumes the `attributeProcedure()` is still running and increases the thread's priority. If it can lock the attribute, it then must see if the mode is set to `COMPUTE`. If so, `attributeManager()` has not yet started the `attributeProcedure()`, and the program temporarily boosts `attributeManager()`'s priority. When the function has successfully locked the attribute and the mode is `COMPUTED`, the function can return the attribute's value. On failure, the function returns `NULL`.

The `detachAttribute()` function is the last procedure required for a minimal attribute manager. This function examines

the list of currently attached attributes for the attribute `Id` specified. Then it uses the `REMOVEMEMBER` macro to detach the attribute from the object (i.e., remove it from its view). The function must also remove the attribute from the attribute type view maintained as part of the `AttributeTable`. Note that it would be more efficient to test the object's complete attribute `SET` to determine whether the attribute is currently attached to the object.

Y ou can enhance ADAM for particular applications.

Establishing Attribute Procedures

The actual attribute procedures and the attribute type information are defined in `attrfunc.h` and `attrfunc.c`, found in the full version of the listings (available electronically). The header file contains some constant value definitions for the attribute types. I introduce only three attribute types; although they're not extremely useful, they provide an easy example of how to implement attribute types. The tunable parameters for the attribute manager may change from one application to the next.

The attribute procedures, along with the `AttributeTable`, appear in the `attrfunc.c` module. These procedures return an `ATTR_VALUES`, since they assign the value to the attribute. Depending on the multithreading APIs your operating system uses, it may be easier to implement the value assignment within the procedure. Note, however, that the procedure must also set the mode and clear the attribute's semaphore in this situation.

The attribute table definition also appears in the full version of the listings. The static initialization provides a simple example of how to define the table. Some of the information provides the default values when the `attachAttribute()` function creates the attribute. If you change the table definition, be sure to update the `attach` function to provide proper initialization. An enhancement to the basic attribute manager might use an attribute dictionary with predefined attributes that are pulled in only when needed.

The `AttachAttribute()` and `De-`

`tachAttribute()` functions can attach to or detach from an object, respectively. The process of attaching an attribute results in the new substantiation of the attribute using base rules for the default attribute settings. When the application calls the `DetachAttribute()` function, it loses all references to that particular attribute's instantiation.

Note that, due to the time-slicing/priority schema of the OS/2 scheduler, the expiration of a derived attribute's period may not cause immediate recalculation of its value. However, the attribute timer thread will find the attribute's value to be out of date the next time this thread executes.

Enhancements

I've left plenty of room for enhancements to ADAM, but I've made no provisions for derived user-defined attributes. All user-defined attributes, by default, use `INTRINSIC` modeling. You can enhance ADAM for particular applications, and these enhancements could include support for attribute dependencies, integrity constraints for attribute values, shared attributes, and even an attribute dictionary.

Attribute dependencies arise when an object has a particular attached attribute and—solely because of that attribute—you can attach another attribute. You have formed a dependency when you would receive an error if you attached the second attribute without the first.

Consider an object representing a person, for example. An attribute of this object might be the person's gender. If you attach the "Male" attribute, you can then attach an "Adam's Apple" attribute. The second attribute is describing a characteristic of the person attribute, not the object. This leads to an attribute hierarchy. The attribute manager as implemented here does not support dependencies, but you can easily add it.

Integrity constraints between attributes, as defined by `CACTIS`, state that a Boolean relationship between two attribute values must evaluate to `TRUE` or one (possibly both) of the values must be recalculated. An integrity constraint would offer significant benefits, and you can easily add it. I have given the type definitions in listing 2. To implement the constraint functionality, modify the `attributeProcedure()` function on return from the attribute's defined procedure call. You can also add a value-check constraint so that when the attribute value does not meet the value check condition, the `attributeProcedure()` function immediately detaches from the attribute.

Yet another enhancement might support an attribute shared by one or more



Impressive any way you look at it.



Our Still Video Imaging Kits let you convert objects into digitized images, ready for use on Mac, PC and Windows programs like PageMaker™, Ventura™, Photoshop™, Persuasion™, MediaMaker™ and HyperCard™.

Impressed? Call 1-800-221-3333
ext. 313 for dealer locations
and a free brochure.



© 1991 Canon U.S.A., Inc.
One Canon Plaza, Lake Success, NY 11042

Brand and Product names are trademarks
of their respective holders.

objects. Since the application object's data is independent of the attribute, it could share an attribute between one or more objects.

The full version of the listings contains a program stub for the main() function, which creates an object and then attaches the three attributes defined in attrman.c. I compiled the program, along with the attrman.c, attrfunc.c, and resource.c (see listing 1 of last month's Some Assembly Required) with Microsoft C 6.0Ax using the compile options

```
cl -c -AL -Ox -I
```

and linked using

```
link /PM:VIO main+resource+  
attrman+attrfunc,,,LLIBCMT;
```

ADAM may seem complex, but its approach has many advantages. As operating systems that support parallel multitasking emerge, you'll need a well-defined methodology to take advantage of their power. ADAM takes you a step in the right direction. ■

BIBLIOGRAPHY

- Chiueh, T., and R. Katz. "Traite: An Attribute Management System for VLSI Design Objects." *Proceedings of the 1991 ACM Sigmod International Conference on Management of Data*, May 1991, pp. 228-238.
- Hall, W. "Adapting Extended Processes to the Cooperative Multitasking of Microsoft Windows." *Microsoft Journal*, January 1991, pp. 21-32.
- Holub, A. *Compiler Design in C*. Englewood Cliffs, NJ: Prentice-Hall, 1990, pp. 132-151.
- Hudson, S., and R. King. "Cactus: A Self-Adaptive, Concurrent Implementation of an Object Oriented Database Management System." *Journal of the ACM Transactions on Database Systems*, September 1989.
- Kawalec, M. "Implementing Critical Sections: A Performance Tip." *IBM Personal Systems Developer*, IBM Corp., Summer 1990, pp. 62-65.
- Letwin, G., *Inside OS/2*. Redmond, WA: Microsoft Press, 1988, pp. 69-77.
- Nguyen, T., and R. Moskal. *Advanced Programmer's Guide to OS/2*. New York: Brady Books, 1988, pp. 71-163.

Charles J. Northrup is the principal of Kingston Technology, Inc., a software services firm in Old Bridge, New Jersey. He is writing a book on multithreaded application design. You can reach him on BIX c/o "editors."

ON-THE-FLY DISK COMPRESSION

Hard drive prices have come down quite a bit over the past year. Thus, squeezing every precious megabyte out of existing hardware is not the critical concern it once was. Still, the market for file-compression utilities is thriving, as more sophisticated applications deal with larger and larger amounts of data.

Some file-compression utilities (e.g., PKZip, ARC, and LHARC) operate at the command line and on an entire file at a time. Softlogic Solutions' Cubit operates on the fly, but it does so by decompressing the entire file when it is opened and recompressing the file when it is closed. Other products, such as Stacker from Stac Electronics, operate completely on the fly—decompressing during read operations and recompressing during writes.

This month, I give you an on-the-fly file compressor that I call Diet Disk. Like Stacker, Diet Disk operates at the level of file read/write operations. You load the DIETDISK.COM TSR program (which occupies about 24 KB of RAM) when you boot up your computer. You follow a few simple procedures, and you get back a large amount of disk space. I can't predict

How to transparently trim the fat from your PC's hard disk

exactly how much you might get back; that depends on the contents of the data files you use. Some files are better candidates for compression than others. You'll also be interested to know that Diet Disk, although fast, is somewhat slower than Stacker (any compression operation, at any level, takes time to run).

Can I Trust It?

Diet Disk works with the applications I've used during testing, but I can't guarantee its operation in all possible situations. The DIET.DOC file that accompanies the software explains how you can test for compatibility with your applications. But as the documentation points out, a larger hard drive and uncompressed access may be the only way to put your mind at ease.

How It Works

Diet Disk intercepts DOS-file activity, handling calls that use file-control blocks

as well as those that use file handles. To Diet Disk, each file is a collection of 2-KB segments. It treats each segment as a separately compressible entity. When an application program seeks into a file and reads a certain number of bytes, Diet Disk calculates the segments that it needs, reads the segments, decompresses them, and puts the result into the application's read buffer. When an application writes data, Diet Disk organizes the data into 2-KB segments, compresses each segment, and writes the compressed data into the file.

Diet Disk's compression and decompression modules are based on the LZW (Lempel-Ziv-Welch) compression algorithm. LZW (which is also used in PKZip, ARC, and Unix's `compress`) is a dictionary-based compression scheme that was first described by Terry Welch in an article called "A Technique for High-Performance Data Compression" (*Computer*, June 1984).

Diet Disk comes complete with source code. Whether or not you use it to conserve space on your hard disk, you'll find Diet Disk a helpful starting point for building TSR, file handling, and compression programs. ■

MAC/Tom Thompson

Managing Your Apple Menu

One of System 7.0's finer features is the opportunity it affords you to customize the Apple Menu. When you drop a document or application into the Apple Menu Items folder, it appears in the Apple Menu, where it's easily accessible.

Unfortunately, making the alias file and putting it in a folder inside the System folder involves a lot of clicking and dragging. Peter Kaplan's freeware AppleEase utilities provide an easier solution.

There are two components: AppleEaseIn is an application that creates the alias file and copies it to the Apple Menu Items folder. You simply drag the icon of the file, folder, or drive onto the AppleEaseIn icon, and it does the rest. AppleEaseOut is an extension that undoes the work of AppleEaseIn. Hold down the Option key when you select an item in the Apple Menu, and that file is moved back onto the Desktop.

UNIX/Ben Smith

Navigating Through Usenet News

Usenet News is a heterogeneous but anarchistic worldwide collection of computer users that generates more than 6 MB (some 6000 printed pages) of information daily. If you participate in Usenet, you can find the sheer volume of information overwhelming—even if you limit yourself to very few of the more than 600 news groups. Several important public domain news-reading programs have emerged in the last few years to help you navigate. The most notable are `rn` by Larry Wall (the same Larry Wall who wrote `patch` and `perl`) and `nn` by Kim Fabricius Storm of Denmark. Both programs are capable of extensive filtering and handle new messages with a variety of tools. Wall's `rn` is particularly strong in its regular expression operations. The strongest feature of `nn` is its organization of the subject threads within a news group. (Due to program size, these programs are not available on disk.)

Editor's note: Software Corner highlights public domain, freeware, and shareware programs. The programs are available in electronic format. See "Program Listings" on page 5 for details. We solicit your contributions. We pay \$50 for any program we use. Write to: Software Corner, BYTE, One Phoenix Mill Lane, Peterborough, NH 03458.

NDP Fortran & C++ for OS/2!

If you are an OS/2 2.0 developer or user, and you need an excellent C++ or Fortran, your wait is over. Microway is now shipping its NDP family of 32-bit 386/486 languages for OS/2. These mainframe/production grade products are based on our core 386 technology which currently runs on DOS, UNIX and WINDOWS and has passed exhaustive validation testing on OS/2. They produce globally optimized code which takes maximum advantage of the Intel 386 architecture and can directly access OS/2's 32-bit API and 2 gigabyte address space.

If you are thinking about porting a large program to a DOS compatible operating system, we think OS/2 is your best choice, today. It has numerous features, such as fast I/O, that make it preferable to 32-bit DOS Extenders, except when direct access to your hardware is needed.

The NDP compilers have been in use since 1987. During that time, NDP Fortran has been used to port thousands of 3090, Cray and VAX applications to the 386/486. It has MS, VMS and VS Extensions. NDP C/C++ is a true com-

piler that is AT&T 2.1 compliant and contains a C subset compiler which is both ANSI and K&R compliant. For the months of May and June, Microway will be making these products available to OS/2 Expedite Members at a pre-release price of \$295.

Microway has been serving the PC community for ten years and we wish to thank all of our customers for their continued support.

For more information, please call Microway's Technical Support Dept. at (508) 746-7341.

386, i486 and i860 Compilers

Our NDP family of compilers generate globally optimized, mainframe quality code that runs on the 386, i486, or i860 in protected mode under Windows, DESQview, UNIX, XENIX, SunOS, or extended DOS. The compilers address 4 gigabytes of memory while supporting the 287, 387, Weitek, and Cyrix EMC coprocessors. Applications can mix code from all four compilers and assembly language. To simplify your ports, we offer ClearView, our full-featured, windowing symbolic debugger that works with DOS versions of NDP 386 and i486 compilers.

NDP Fortran™ is a full F77 with F66 and DOD extensions that is 99% VMS compatible. Also contains new F90 features & MS compatibility.

NDP C/C++™ runs in three modes: K&R with Sys V and MS C extensions; 100% ANSI C; and C++ Release 2.1 compatible.

NDP Pascal™ is a full ANSI/IEEE Pascal, with extensions from C and BSD 4.2 Pascal.

NDP Language Pricing

NDP Fortran, C/C++, or Pascal — DOS products and EZWIN32 include NDP Tools and Extender. 486 DOS version includes Weitek support, royalty free binder, and Clearview-386. All DOS compilers come with GREX.

- OS/2™ \$595
 - EZWIN32 (includes Tools) \$595
 - 386 DOS (includes DOS Extender) ... \$695
 - 486 DOS (includes DOS Extender) .. \$995
 - 386/486 UNIX or XENIX \$1195
 - i860 Compilers \$1995
- (OS/2 is a trademark of IBM Corporation.)

Clearview-386™—our windowing 32-bit symbolic debugger that runs with our 386 and 486 DOS products \$195

GREX 386/860™ — A library of 160 lower level graphics routines (free with DOS compilers): \$495

NDP-CrossRef™ Our full function cross reference utility that produces comprehensive data and function listings. Available for all NDP compiler versions \$195

NDPPlot™ \$195

NDP/FFT™ NDP or 80x87 version ... ea. \$250

Halo Professional for 386 \$595

NDP NAG™ Workstation library is a subset of the NAG mainframe libraries. Has 172 routines for differential equations and eigenvalue problems, matrix operations, fitting curves, statistics, and regression analysis 386 Version: \$895

T800 NAG for Transputers \$2750

Number Smasher-860™

Number Smasher-860 is the highest performance coprocessor card ever to run in an ISA or EISA bus or as part of a transputer system. Delivers up to 80 million floating point operations per second at 40 MHz and produces 11.8 double precision Linpack megaflops. The board comes standard with an EISA or ISA interface, 8 meg of high speed memory, and your choice of NDP Fortran, C/C++, or Pascal for the i860 running under MS-DOS, UNIX, XENIX, SunOS, or DESQview 33 MHz: \$5000

40 MHz: \$6000 32 MB version: add \$2500

i860 Vectorizers and Libraries

NDP NAG/860 is a Microway port of the NAG workstation library to the i860 \$1495

NDP HALO-860 includes HALO Professional and an interface library which makes HALO directly callable by the i860 \$995

860 Vectorizer includes PSR VAST-2 which converts a C or FORTRAN program into a new program which calls the Intel Vector library. Includes the Intel Vector Library and Microway's i860 Profiler \$1495

860 Vector Library — Written for Intel, includes over 400 vector primitives that take advantage of the i860's cache, dual instruction mode, and pipelined multiplier accumulator \$495

NDP IMSL/860 is a Microway port of IMSL mainframe library to the 860.

Math Library: \$995 Statistical Library: \$995

Special Functions: \$500 Complete pkg: \$2000

IGL — a 3-D Graphics Pipeline that does geometry and rendering using routines which use the i860's built-in graphics hardware \$495

Kuck & Associates CLASSPACK Hand coded libraries for the i860.

- **CASIC Math Library** \$500
- **DSP** — Over 100 routines including 1 and 2-D correlations and convolutions. Does 1024 Complex FFT in 1 msec \$750
- **Dense Array solver package** \$750

SX Your AT!

FASTCache-SX/Plus™ — The "Windows Solution" — easily converts your 286 into a powerful 25 MHz 386SX by combining Microway's award winning FASTCache-SX accelerator (\$299) with up to 16 megabytes of extended memory. Features a 486-style 16K internal cache from Intel and a 387SX coprocessor socket. Uses a 16-bit slot. (Cable Kit & 2 meg included FREE.)

FASTCache-SX/Plus-25 \$595

386/486 Workstations

One of Microway's Black Towers is the ideal choice for a cost-effective desktop system, personal supercomputer, file or computation server, or an industrial PC. They come standard with two or more thermostatically controlled fans, 250 Watt motherboard power connectors, and American-manufactured industrial power supplies. Our 386 and 486 motherboards are carefully burned in and tested. Top speeds are 40 MHz for the 386 and 50 MHz for the 486. Each user can choose from a full line of high quality options to customize the workstation to his specific needs. Our 486B²™ was a recent *Digital Review* Target Award nominee. The base system includes a sleek, black tower case, a black tactile response keyboard, four megabytes of memory, a 250 Watt American power supply and one floppy drive. Each system is backed up by a one year warranty and the best technical support in the industry.

- 386B²-40 ISA 64K cache 200W \$1595
- 486B²-33 ISA 64K cache 250W \$2295
- 486B²-33 ISA 256K cache 250W \$3395
- 486B²-50 EISA 256K cache 250W \$3995
- 486B³-50 EISA 256K cache 350W \$4495

Parallel Processing

Microway's ongoing R&D is based on the INMOS T800, T9000, and Intel i860. We recently achieved 90% efficiency and 132 megaflops running two i860s in parallel. Our T800 products are T9000 object compatible, making them ideal development platforms for this new superscalar RISC processor.

Quadputer™ — This board for the AT or 386 can be purchased with 1 to 4 transputers and 1 or 4 meg of memory per transputer. Two or more Quadputers can be linked together to build transputer networks from \$1845

Monoputer™ — Includes one T800 and up to 16 meg of RAM from \$1295

Math Coprocessors

- WEITEK: 4167-25/33** \$750/\$995
- 3167-20/-25/-33** \$350/ \$600/ \$750
- mW3167 Micro Channel-25/33:** from \$850
- mW3167/80387 Board** \$200
- INTEL 387-16SX:** \$120 **387-20SX:** \$135
- 387 16-33:** \$190 **287XL:** \$80
- Cyrix: SX20MHz:** \$100
- SX25MHz:** \$110 **287 20 MHz:** \$75
- DX33 MHz:** \$155 **DX40 MHz:** \$185
- EMC-33 MHz:** \$250 **EMC-40 MHz:** \$300

World Leader in PC Numerics

Corporate Headquarters: P.O. Box 79, Kingston, MA 02364 USA (508) 746-7341
32 High St., Kingston-Upon-Thames, U.K., 081-541-5466

USA FAX (508) 746-4678 Germany 069 75 2023 Norway 06 89 2020 Italy 02-74.90.749 Japan 047 423 1322

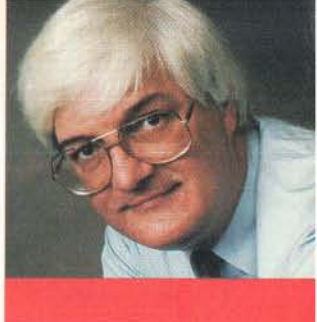

BARRY NANCE

WINDOWS NT AND OS/2 COMPARED

IBM is now giving birth to OS/2 2.0, and Microsoft is still pregnant with Windows NT (New Technology). Thus, all comparisons of the two operating systems have to be taken with a grain of salt. However, Microsoft Press has published *The Windows 32-bit Guide to Programming*, which gives programmers an overview of what Windows NT will look like. Don't tell Microsoft this, but it also helps that I got a chance to see Windows NT in action, at one of the exclusive alpha sites, by looking over a friend's shoulder. Meanwhile, on the OS/2 side, IBM has kept me posted with frequent beta releases of OS/2 2.0 because I've been writing a book on that subject.

I'm immediately struck by the similarities between OS/2 2.0 and Windows NT. Both operating systems offer a flat 32-bit memory model (no more 64-KB segments); multiple threads; protection of applications from one another; DLLs and DLL-handling functions; named pipes; drag and drop functions; and DDE, clipboard data exchange, and similar memory allocation schemes. Microsoft is also rumored to be developing a 32-bit version of the DOS FAT (file allocation table) file system. If that happens, both operating systems will sport advanced file systems: OS/2's High Performance File System and NT's super FAT. Designed originally just for disk files, the DOS FAT file system may outlive both OS/2 and Windows NT!

Windows NT clearly benefits from work done at Microsoft on what was once the OS/2 3.0 project. However, it is a from-scratch effort that began at DEC several years ago under the direction of David Cutler. When DEC killed the project, the development team moved to Microsoft to complete its work. Cutler brought ideas—but no code—from DEC.

IBM and Microsoft thought of OS/2 3.0 as the "portable successor to OS/2." After IBM and Microsoft went their separate ways, Microsoft decided to layer a 32-bit Windows interface on NT in place of PM

(Presentation Manager) and to customize NT in other ways.

Microsoft says it will offer the 32-bit Windows API with a future version of DOS and Windows, in addition to making the API available on the NT operating environment, but that's still controversial. Sources close to the NT team at Microsoft tell me that the NT developers themselves don't believe that "Win32 on DOS" will actually happen.

Measuring the Differences

Windows NT embodies a microkernel, layered architecture. This is an excellent way to design an operating system. Subsystems and modules attach to the base operating system on demand. I admire Mi-

crosoft for taking this approach. If Microsoft can prevent performance from suffering because of all the layers of modular code, it will have created a cleanly designed operating system that may very well last into the next century. Sluggish performance, however, would be the kiss of death for Windows NT, no matter how well it's designed.

As you'd expect in a protected 32-bit environment, you can't do direct-port I/O under Windows NT. You can't modify the system date and time, nor can you read or write the Windows.INI files directly. Microsoft suggests that you review your structure member alignments in the new 32-bit world.

The Windows NT 32-bit API is an extension of the Windows 3.1 API. Programmers will have to make a series of adjustments to their code to compile the application for Win32. Specifically, `lParam` and `wParam` are both 32-bit (4-byte) fields. Windows 3.x usually packs a handle and another value into `wParam`. Windows NT changes the way the packing occurs. To retrieve `WM_COMMAND` messages, for example, you'll use macros that hide these packing differences. The new `WINDOWS.H` file also contains 32-bit `typedefs` for things like `LPSTR`, `hInst`, and `hWnd`.

Windows 3.x applications that make use of expanded or extended memory or that use the DOS function call `INT 21` hexadecimal interface will need to be recoded slightly. Windows NT will run on the Mips R4000 RISC processor, which doesn't have expanded memory, extended memory, or `INT 21h`.

Every Windows NT application must register its own window classes. Thus, `hPrevInstance` always returns `NULL` under Windows NT. If you use `hPrevInstance` to determine when you should share data with an already-running instance of your application, you'll need to switch to some form of interprocess communication. As an alternative, you could call

Will Microsoft's new operating system be a better OS/2 than OS/2?



FindWindow() to help determine which instance is which.

The Biggest Difference

To me, the biggest features of Windows NT are localized input and threaded-message queues. Windows NT will determine the ownership of a user's/operator's input at the time the input occurs, not when that input is extracted from a system message queue. Each thread will have its own message queue and its own input-synchronized-state information. The result is no more hourglass cursors. If one application fails to process its message queue quickly enough, other applications aren't affected. The other applications and their threads have separate message queues.

It's too bad that PM doesn't feature threaded-message queues. On the downside, however, Windows programs that call functions like SetFocus() and GetCapture() will have to change to accommodate localized input. For example, if you subclass a window control or try to detect nonclient mouse/window activity, you may need to rework your code slightly. In a Windows environment, it's difficult to deal with parent windows that don't

The biggest features of Windows NT are localized input and threaded-message queues.

have a separate window ID. Under PM, every window has a window ID, even top-level windows. The window owner and parent are separate. You can deal with and manage them individually. PM programmers don't need to use the WS_CHILD, WS_POPUP, and WS_OVERLAPPED styles you find in Windows programs.

The Multiprocessor Angle

Windows NT will be able to run in a multiprocessor environment. High-end PCs

with multiple CPUs will use Windows NT to advantage. You'll see the benefit of multiprocessing when Microsoft ports LAN Manager to run under Windows NT. But don't forget that Intel will announce the 586 chip later this year and that IBM has a special relationship with Intel. The 586 will embody multiple processors on a single chip. OS/2 will take advantage of the 586 soon after it's announced.

Microsoft has shown Windows NT running on Mips R4000-based computers as well as 386 and 486 machines. While IBM has made no public statements about OS/2 2.0 running on a RISC machine (e.g., the IBM RISC System/6000), I have a bit of personal knowledge. Last year, I visited IBM's Austin, Texas, facility. During a coffee break, I stuck my nose where it was not supposed to be and happened to see OS/2 running on a RISC System/6000.

Which Is Best?

OS/2 will require less-expensive hardware and will have better support for character-mode applications—something that NT supports but does not encourage. I expect that OS/2 will run DOS-based software better and faster. To run DOS software

GREAT THINGS COME IN SMALL PACKAGES

This powerful print server can tackle your biggest network printing problems

- Connects any parallel printer directly to your Ethernet LAN
- Fully Novell Network 286 and 386 compatible
- Can attach to 8 file servers simultaneously
- Fast and easy to install
- Combines high-speed printing and exceptional printer control
- Supports encrypted passwords, forms, notify, cancel, and others
- Full one-year warranty and unlimited free technical support
- Made in the U.S.A.



Make the Rose Connection

ROSE
ELECTRONICS

10850 Wilcrest Drive • Houston, Texas 77099 • Phone (713) 933-7673 • Fax (713) 933-0044

360 BYTE • JUNE 1992

1-800-333-9343
Circle 313 on Inquiry Card.

Your interface doesn't have to be a straitjacket.



C-scape is the most flexible user interface package for text or graphics-based applications.

All too often user interface management systems force you to program with your hands tied. You do things their way or not at all.

C-scape sets you free. It provides powerful features - scrolling windows, mouse support, menus, text editors, help, data entry, etc. - yet lets you tie your own functionality to these objects without touching the underlying code.

What's more, C-scape's object-oriented architecture makes it easy to integrate with any other C library. So you aren't locked into one solution.

locked into one solution.

Unlike many other screen managers, C-scape is a true windowing environment. Which makes it powerful enough to tackle the most

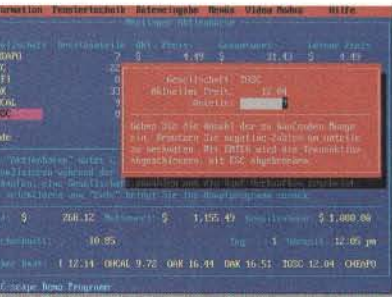

...and on character-based terminals...

demanding user interface requirements.

C-scape is also so easy to use you can affordably build elegant new interfaces even for simple applications and databases.

Prototyping and code generation are no problem. C-scape's Look & Feel interactive screen designer lets you create full featured

screens, test them, and then automatically generate complete C source code or binary screen files.

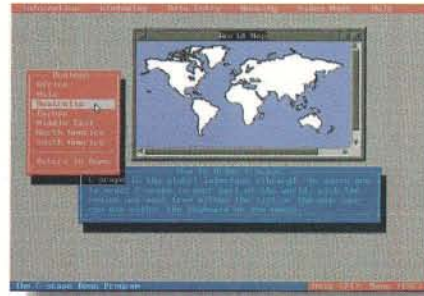

Applications built with C-scape can run on PC's...

C-scape applications port without modification across DOS, extended DOS, OS/2, UNIX, AIX, the X Window System, QNX and VMS.

And since C-scape supports text and graphics

simultaneously, it's a smart choice for users who want to add graphics to existing text applications.

See for yourself why thousands of programmers worldwide use C-scape. Call for a copy today. And escape the interface straitjacket.

Liant is the world's leading supplier of open systems programming tools, languages, and libraries. Call for your free Liant product catalogue.

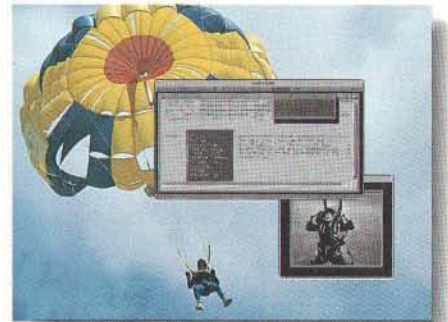

...and under the X Window System.

30 DAY MONEY BACK GUARANTEE. CALL FOR FREE DEMO.

LIANT

Australia Noble Systems (02) 564 1200; Aus./Ger./Switz. ESM (070) 22 34077; Benelux TM Consult (02503) 26312; Denmark Ravenholm (042) 887249; France Smartline (01) 4634 6419; Italy Soft Team (049) 82 91285; Norway Ravenholm (02) 448855; Sweden LinSoft (013) 111588; U.K. Systemstar (0992) 500919. All other inquiries: Oakland Group, GmbH +49 (0) 30 391 5045.

Liant logo type, C-scape and Look & Feel are trademarks of Liant Software Corp. Other trademarks belong to their respective companies. Copyright © 1991 by Liant Software Corp., 959 Concord St., Framingham, MA 01701, U.S.A. 508-872-8700, FAX: 508-626-2221.

under NT, Microsoft licensed an 80x86 emulator from Insignia Solutions. But 80x86 emulators are tricky. IBM quietly offers such an emulator on the RISC System/6000, called PC-Simulator. When I went to Austin, I was there to help IBM with some PC-Simulator problems. Early versions of OS/2 taught the bitter lesson—either you run the 20,000 DOS applications that exist or you don't sell.

From the perspective of a business application programmer like myself, I see OS/2 2.0 and Windows NT competing for three different audiences. In the first group are programmers who write commercial products. In the second group are in-house professional programmers who create software their companies use to run their day-to-day operations. In the third group are the casual programmers who write software to help automate their departments' work load.

Many in the shrink-wrap camp will divide into two or more teams and write versions of their products for both NT and OS/2, with perhaps versions for Unix, Next-Step, and the Mac. Small companies without enough programming resources to create multiple versions of their products have

two choices: Toss a coin and pick an operating system or use a virtual toolkit that spans multiple platforms. The choice depends partly on the type of application. If you're in this camp and your application won't tolerate the overhead of a virtual toolkit, I can't tell you which operating system you should bet the farm on.

I'd guess that many in-house professional programmers will want to write for OS/2. Why? OS/2 2.0 already offers the features that developers asked for when they complained about DOS (not enough memory, too simple, and 64-KB segments) and Windows (too easy to cause an unrecoverable applications error). The casual programmer will likely continue to use DOS or DOS and Windows to create small-scale, helpful software.

It Will Be Ready When?

Ultimately, OS/2 and Windows NT are very similar. NT has a lot of nice features; OS/2 has nice features of its own. Different programmers will prefer each one for different applications.

If IBM enhances OS/2 to encompass features like threaded PM message queues and multiprocessor support, the competi-

tion between Microsoft and IBM may boil down to a simple price war. If this happens, a customer-driven company like Apple will surely be the winner.

Software projects never finish when the marketing people say they will. In fact, software projects hardly ever finish when *programmers* say they will. Windows NT 1.0 is an ambitious effort, and I expect that its birthing pains will be similar to those of OS/2 2.0. As a programmer, I feel safe telling you that if Windows NT is a real for-sale product able to run DOS, Win16, Win32, and other types of applications by the end of the year, I'll eat a disk. However, let me temper that by saying I also expect that I'll probably do some Windows NT programming in 1993 or 1994. ■

Barry Nance is a contributing editor for BYTE. A programmer for 20 years, he is the author of Using OS/2 2 (Que, 1992) and is the exchange editor for the IBM Exchange on BIX, where you can reach him as "barryn."

Your questions and comments are welcome. Write to: Editor, BYTE, One Phoenix Mill Lane, Peterborough, NH 03458.

One portable Valitek backs up all your PCs!

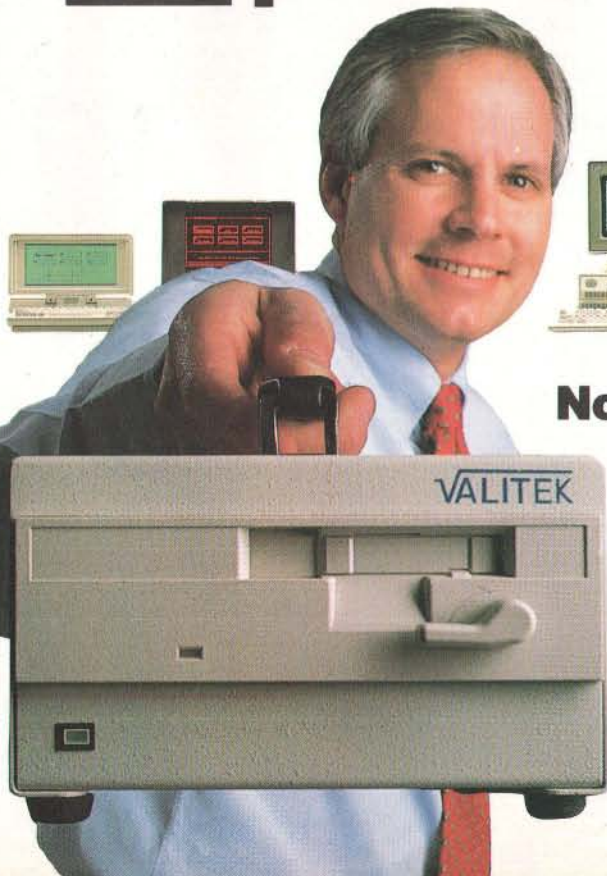

No controller card needed!

The Valitek PST is a rugged, reliable, and simple backup solution; just pick it up and plug it into the parallel or serial port of virtually any IBM or compatible PC, old or new. No jumpers, no switches, no need to format media. Up to 4.5 MB/min.; 60, 160, and 250MB models. And it's a great way to distribute large databases to many PCs. Compelling economics, too: buy just *one* Valitek to back up *all* your PCs.

Call (800) VALITEK or
(413) 549-2700; FAX (413) 549-2900

VALITEK

Circle 326 on Inquiry Card.

10 WEEK
LABS
ANALYST'S
CHOICE

Oct. 15, 1990
PST-160

CHIP
PRODUKT
DES MONATS

Feb., 1991
PST-160

NOTICE

WE'VE BEEN ASKED TO MAKE IT VERY CLEAR THAT
THERE'S A WHALE OF A DIFFERENCE BETWEEN QNX® AND UNIX®

WE'RE GLAD TO OBLIGE.

EVEN THOUGH THE QNX REALTIME
OPERATING SYSTEM IS NOT BASED
ON UNIX SOURCE CODE, WE CAN
UNDERSTAND HOW SOME DEVELOPERS
MIGHT CONFUSE THE TWO. AFTER ALL,
QNX FOLLOWS THE LATEST IEEE
POSIX 1003.1 AND 1003.2 OPEN
SYSTEMS STANDARDS, SO YOU GET
THE SAME API AND UTILITY SET
FOUND IN MANY UNIX SYSTEMS.

BUT LOOK BENEATH THE SURFACE
AND YOU'LL SEE TWO
FUNDAMENTALLY DISTINCT
ARCHITECTURES. A MONOLITHIC OS
ON THE ONE HAND, A MICROKERNEL
OS ON THE OTHER. THEY'RE
DIFFERENT SPECIES ALTOGETHER,
AS DIFFERENT AS A WHALE AND
A SCHOOL OF DOLPHINS.

ARCHITECTURE YOU CAN BUILD ON
QNX'S MODULAR, MICROKERNEL
ARCHITECTURE GIVES YOU
REMARKABLE FLEXIBILITY. OS
SERVICES ARE PROVIDED BY A TEAM
OF COOPERATING PROCESSES RATHER
THAN BY A MASSIVE MONOLITHIC
KERNEL. THE RESULT? YOU CAN
STRIP QNX DOWN TO A ROM-ABLE
EMBEDDED SYSTEM. OR BUILD IT UP
TO A VAST NETWORK AND HARNESS
THE POWER OF HUNDREDS OF CPUS.

OUR PRICING IS MODULAR TOO,
SO YOU'RE NOT FORCED TO PAY
FOR WHAT YOU DON'T NEED.

REALTIME PERFORMANCE

YOU CAN COUNT ON

NEED THE SPEED OF A FAST,
REALTIME EXECUTIVE?
QNX CLOCKS IN AT 16 μ SEC
PER CONTEXT SWITCH ON
A 33 MHZ 80486.

BUT QNX DOESN'T STOP THERE.
WITH ITS PRIORITY-DRIVEN,
PREEMPTIVE SCHEDULING,
YOU CAN BUILD REAL REALTIME
SOLUTIONS.

DISTRIBUTED PROCESSING

YOU CAN BET ON

QNX CAN TRANSFORM A BUNCH
OF ISOLATED MACHINES INTO A
SEAMLESS SUPERCOMPUTER,

ORCHESTRATING HUNDREDS OF
CPUS WITH ITS NETWORK-WIDE IPC.

YOU'RE IN COMPLETE CONTROL
OF ALL RESOURCES AT ANY POINT,
FROM THE PLANT FLOOR
RIGHT UP TO YOUR DESKTOP.

SUPPORT YOU CAN DEPEND ON

DURING THE LAST TEN YEARS,
WE'VE EARNED A REPUTATION
FOR OUTSTANDING TECHNICAL
SUPPORT. WE OFFER EVERYTHING
FROM 24-HOUR ONLINE
CONFERENCING TO ONSITE
CONSULTING, SO YOU CAN EASILY
REACH THE PEOPLE WHO MAKE UP
THE QNX DEVELOPMENT TEAM.
THEIR EXPERTISE CAN HELP
YOU KEEP YOUR DEVELOPMENT
PROJECTS RIGHT ON COURSE.

TO FIND OUT HOW YOUR
APPLICATIONS CAN THRIVE IN
THE QNX ENVIRONMENT,
CALL 1-800-363-9001,
(EXT. 101).



REALTIME OPERATING SYSTEM

Circle 147 on Inquiry Card.

QUANTUM SOFTWARE SYSTEMS LTD.
175 TERENCE MATTHEWS CRESCENT
KANATA, ONTARIO, CANADA
K2M 1W8
TEL: 613-591-0931
FAX: 613-591-3579

ARCHITECTURE MAKES THE DIFFERENCE

ASK BYTE

Pass the PCMCIA

I recently purchased a Sharp PC-3000, a new palmtop IBM XT compatible that is fantastic. Its size is slightly larger than a VHS videocassette, and it has a very large screen.

This product is new in Hong Kong. I have managed to find all the cables and options for the machine except what is referred to as the industry-standard IC cards designed to conform to PCMCIA 1.0 (not more than 3.3-mm thickness). Very little is known here about where to get them. Sharp dealers simply tell me these are not yet available from Sharp. Who might have these cards?

Ted Wilson
Hong Kong

One computer that I have seen that uses the PCMCIA card is Hewlett-Packard's HP 95LX palmtop computer. HP sells two RAM cards: 128 KB (\$199.95) and 512 KB (\$399.95). Computer dealers in Hong Kong should have these cards in stock. I suggest that you take your computer to a dealer and see if they will work. If necessary, you can contact HP at 1000 Northeast Circle Blvd., Corvallis, OR 97330, (503) 757-2000.

The PCMCIA 2.0-specification cards have the same size and physical features, with 68 pins on one end of the memory card. But this newer specification lets you execute programs on the memory cards and use the card port as a generalized I/O device. This means that, theoretically, you can use the cards as system RAM or use the port to connect your computer to hard drives or LANs.—Stan Wszola

The Eyes Have It

I cannot look at a computer screen for more than 15 minutes before my eyes become irritated. I have had an eye examination, and the ophthalmologist tells me that there is nothing special about computer screens that should hurt my eyes.

I spoke with several computer dealers about the problem, and they gave different explanations. Some blame the screen resolution. Others blame refresh rates and recommend a noninterlaced monitor. Both interlaced and noninterlaced monitors hurt my eyes, however.

I've heard of LCD monitors that are thin and flat and that mount anywhere. Would these prevent eyestrain? I'm also interested in knowing about the effect of ultraviolet light, room lighting, and ergonomic factors.

Bryan Chung
Miami, FL

I'm surprised that your ophthalmologist couldn't help you. While computer screens are not inherently evil, they can be hard on your eyes. Your eyes have a natural "resting point of accommodation," where they tend to focus when relaxed. For most people, that falls somewhere between 20 feet and infinity. A typical computer monitor is 20 to 28 inches from your eyes. As you use the computer, your eyes have to constantly work to keep fo-



cused at this close distance.

Folks who sit and stare at a screen all day compound the problem by forcing their eye muscles to hold this unnatural position for long periods of time and making constant tiny left-right movements to read lines of text. Periodically, look away from the screen and focus on some distant object.

Color is another factor. Different wavelengths cause the retina to focus differently. Chromatic aberration

makes your eye constantly focus in and out as you look at different colors on the screen. While color is great for some things, it can make working with text needlessly painful. LCDs may not be any better. While they don't have the radiation and flicker problem associated with CRT displays, they are usually smaller and offer less contrast.

Ask your ophthalmologist about glasses ground for reading at computer-screen distances. Adjust the ambient room lighting to be two to three times brighter than the screen background, and position the monitor so it's slightly below eye level. If you're using a color monitor, make sure it's a high-quality unit, the bigger the better, and try moving it farther away.

Even better, switch to a good-quality monochrome monitor. These don't have problems with convergence or dot-pitch limitations, and they generally have better contrast than color tubes. Above all, take frequent breaks. Rest your eyes, look around the room, or take a walk. Computers and Visual Stress from Abacus (ISBN 1-55755-128-6) has a chapter on eye exercises that may help. It also offers a good summary of the problems.

—Howard Eglowstein

Is Your Keyboard Latent?

We received several letters in response to Colin Vernon's letter in the February Ask BYTE. When you press a key on some IBM Enhanced-style keyboards, incorrect characters may appear on your display. The problem is due to a latency problem involving INT9 hexadecimal. Enhanced-style keyboards often generate a long series of scan codes for a single key press. Unfortunately, some BIOSes in AT-class machines let other interrupts occur before the machine has processed all these scan codes for that key press.

A suite of freeware utilities available from BIX or CompuServe solves the problem. You'll find INT009FIX.ZIP in the IBM.PC listings area on BIX or in CompuServe's PCVEND Forum as INT9FI.ZIP. These files, which were developed by Artisoft, include documentation.

Also, check out KBDFIX.ZIP in the Borland listings area on BIX. The .ZIP file includes executable files and source code (Pascal and assembly language). The freeware programs don't all work with every computer, so you might need to download both .ZIP files to find a program that works. Thanks to Andy Cooper of Downingtown, Pennsylvania, Lou Marles of Peterborough, Ontario, Canada, and Rich Roth of Artisoft for their suggestions.—Stan Wszola

Se Habla ASCII?

I work for a data-entry company in the Dominican Republic and have to translate specialized Spanish text into English. Is there specialized translation software for technical documents?

Rafael Mota Legreaux
Queens, NY

Machine translation has become a hot market. See "The Multilingual Edge" in the March 1991 *BYTE* for an overview of the technology, explanations of machine translation terminology, and a company list.

Globalink (9302 Lee Hwy., Suite 440, Fairfax, VA 22031, (800) 255-5660, ext. 29, or (703) 273-5600; fax (703) 273-3866) has a translation system for the PC. GTS Basic (\$498) includes a 2-MB general dictionary. GTS Professional (\$995) lets you add subject-specific dictionaries (i.e., business-finance, legal, and computer terminology) for \$100 each. Either version lets you add new words to the primary dictionary.

One of the complaints about machine translation is the literal, word-by-word method the software uses to translate a document. A translating thesaurus like *Lexica* from WordStar International (201 Alameda del Prado, Novato, CA 94949, (800) 523-3520 or (415) 382-8000; fax (415) 883-1629) can help polish up the final translation. *Lexica* groups words according to concept, so you can analyze meanings and nuances. The five-language version of *Lexica* (English, French, German, Spanish, and Dutch) sells for \$295.—Stanford Diehl

Speaking by Numbers

I am interested in speech-controlled input for PCs. I'd like to use such a system for bookkeeping. Instead of typing in the numbers manually, I'd like to speak the numbers into a microphone and have them appear in the program. I would appreciate any information about these voice-recognition systems and where to get them.

Peter Darnert
Peia, Argentina

Two inexpensive options are the Voice Master (\$149 from Covox, Inc., 675 Conger St., Eugene, OR 97402, (503) 342-1271; fax (503) 342-1283) and the Bug Voice Command System (\$799 from Command Corp. (3675 Crestwood Pkwy., Duluth, GA 30136, (404) 925-7950). You might also try Verbox Voice Systems (1090 King Georges Post Rd., Building 107, Edison, NJ 08837, (908) 225-5225; fax (908) 225-7764) and Votan (6920 Koll Center Pkwy., Pleasanton, CA 94566, (800) 877-8746 or (510) 426-5600). Give these companies a call and tell them the specific application you have in mind.

On the higher end of the PC platform, Dragon Systems (320 Nevada St., Newton, MA 02160, (617) 965-5200; fax (617) 527-0372) has an impressive voice-recognition package called DragonDictate (\$8995), with a 30,000-word vocabulary. IBM VoiceType is based on the same technology, but it has a smaller vocabulary (7000 words) and a smaller price tag (\$3185). Both systems include software and a speech-recognition board.

—Stanford Diehl

Soft on Graphics

I am trying to configure a PC or other system to stamp photographs on clothing. What do I need?

Jorge Rodriguez
Porto Alegre, Brazil

Black Lightning (RR 1, Box 87, Depot Rd., Hartland, VT 05048, (802) 436-3257) remanufactures toner cartridges for Hewlett-Packard LaserJet printers. By adding colored dye to the laser-printer toner, the company has created a sublimation-transfer toner. The toner looks black when you print it onto normal paper, but by heating the paper, you can transfer the image to other surfaces, including fabrics. Black Lightning sells the toner in many colors. Cartridges are \$80 each.

For hardware, you need a laser printer that accepts a Canon EP or EP-S cartridge. Then use any graphics software package that can horizontally flip the image you want to print. The LaserWriter print driver does this automatically. Adobe Illustrator and CorelDraw can also do this. It helps if the software can create color separations. You can then print multiple colors by changing the toner cartridge for each color pass.—Stanford Diehl

Writers' Bundle

I would like information on software called Writer's Toolkit for Windows and other such packages.

Michael Briley
South San Francisco, CA

Writer's Toolkit for Windows is an excellent electronic reference set. It includes Houghton Mifflin's *CorrecText* grammar, style, punctuation, and spelling checker; the *American Heritage Electronic Dictionary*; *Roget's II Electronic Thesaurus*; the *Concise Columbia Dictionary of Quotations*; Houghton Mifflin's *Abbreviation Program*; the *Written Word III: Principles of Grammar and Style*; and the *Dictionary of Common Knowledge*. Systems Compatibility Corp. (401 North Wabash, Suite 600, Chicago, IL 60611, (800) 333-1395 or (312) 329-0700; fax (312) 670-0820) sells the bundle for \$129.

Reference Software International (330 Townsend St., Suite 119, San Francisco, CA 94107, (800) 872-9933 or (415) 541-0222; fax (415) 541-0509) sells the *Writer's Pack* for \$149. It includes *Grammatik IV 1.0*, *WordScience's Definitions Plus*, *The Associated Press Stylebook*, and *KeyNotes Writer's Handbook*.

Choose the package that has the reference works you want or buy a specific reference package separately. That way, you can mix and match to fit your needs.

Also, consider the growing body of reference works on CD-ROM. Call the Bureau of Electronic Publishing at (800) 828-4766 for a catalog.—Stanford Diehl ■

The *BYTE* Lab welcomes your questions. Address correspondence to Ask *BYTE*, *BYTE*, One Phoenix Mill Lane, Peterborough, NH 03458. You can also send BIX mail c/o "editors."

We read every letter, but due to the volume of mail received, we cannot guarantee a response. We edit all letters for clarity and brevity. Letters appear in *BYTE* about four months after we receive them.

WHEN YOU NEED SOLUTIONS, NOT JUST ANOTHER BOARD!

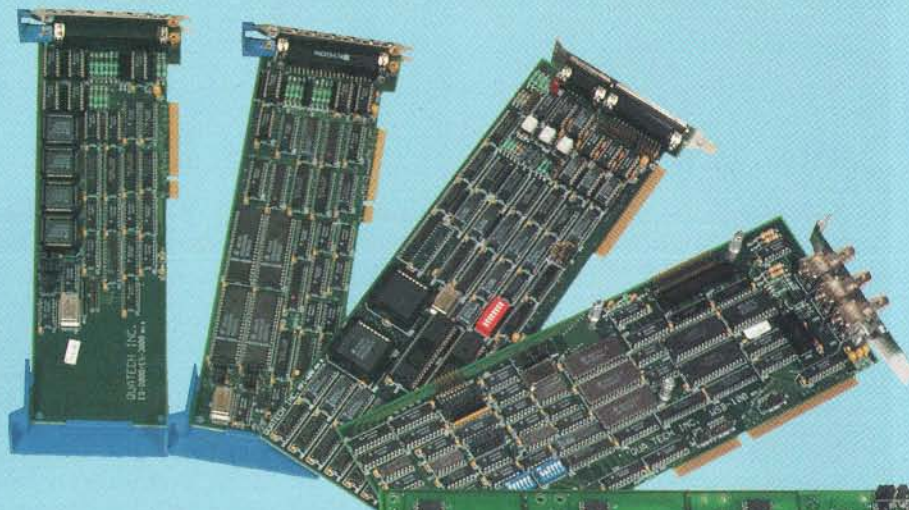

Let a Quatech Sales Engineer show you the value of quality, service and support.

COMMUNICATION

Quatech produces a full line of serial and parallel adapters for PS/2, PC-XT, AT and compatible systems available in RS-232, RS-422, RS-485 and Current Loop. Selectable addresses and interrupt capabilities are featured in our multi-port/user, SDLC, HDLC, and X.25 adapters. Software and 16550 UARTS are available.

DATA ACQUISITION

Quatech has developed a full line of data acquisition products for the IBM AT and compatibles. These high performance, low cost boards provide analog-to-digital, digital-to-analog, and digital input/output functions. A/D and D/A converters are equipped with 8, 12, or 16 bit resolution, and sampling rates up to 1 MHz.

1-800-553-1170



Corporate office: (216) 434-3154, FAX (216) 434-1409, 662 Wolf Ledges Pkwy, Akron, OH 44311 U.S.A. International: Australia/Interworld Electronics 03-563-7066, Canada (Western)/Interworld VCR 604-984-4171, England/Diamond Point International 634-722-390, Finland/Lab Hitech OY 358-0-804-2522, France/Elexo 33-1-69302880, Germany/Jupiter Electronic Systems 06181/75041, Israel/RCM Ltd. 972-03-5447885, Italy/N.C.S. Computer Italia 0331/ 770-016, Netherlands/ACAL Auriema 040-816565, Korea/Sam Boo Enterprise Co. 02-678-7457. IBM PC-XT, AT and PS/2 are registered trademarks of IBM Corp.



Made
in
U.S.A.

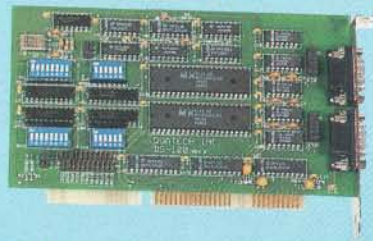

JUNE 1992

READERS' CHOICE AWARDS

PAGE 123

BYTE

A MCGRAW-HILL PUBLICATION

HP's Vectra with Local Bus
Page 53



Managing Infoglut

How to Add Value to Your Data

William F. Buckley Jr.
on Privacy

Special Report:
The Most
of Windows

Color
Script
ers
\$8000

Hi-Res
or Monitors



MAIL ORDER

HARDWARE/SOFTWARE SHOWCASE

BUYER'S MART

BUYER'S GUIDE

Mail Order

The latest offerings from vendors supplying products of all leading manufacturers at extremely competitive prices.

368

Hardware/Software Showcase

This categorized four-color display section makes it easy to find Hardware and Software products from a wide variety of manufacturers and suppliers.

402

Buyer's Mart

From Accessories to Laptops to Word Processors, you can easily find the dealers you are looking for in this directory of products and services.

411

BYTE

Get A Lode Of This.

Our Three-Way Guarantee Just Got Better.

The LodeStar Three-Way Personal Guarantee has always been one of the industry's most comprehensive. But now it just got better. Introducing The LodeStar Five-Way Personal Guarantee. Now, every LodeStar system is covered five ways to insure your complete satisfaction. And that should take a lode off your mind.

1. MONEY BACK GUARANTEE.

If you change your mind for any reason simply return your LodeStar system to us in original condition within 30 days of your receipt and we'll refund your money.

2. FREE LIFETIME TECHNICAL SUPPORT.

For as long as you own your system, we'll give you FAST, FREE unlimited technical advice and guidance from our expert staff. This includes any support needed to upgrade or modify your system.

3. FREE LIFETIME LABOR SUPPORT.

Although you will probably never need it, for as long as you own your system, it will be protected by our 100% labor warranty.

4. FREE 2-YEAR PARTS WARRANTY.

For a full two years after purchase, your LodeStar computer will be covered by our 100% parts warranty, with fast turn around on any replacements.

5. FREE 1-YEAR ON-SITE SERVICE.

For a full one year after purchase, you'll have the added security of our coast-to-coast FREE on-site service.

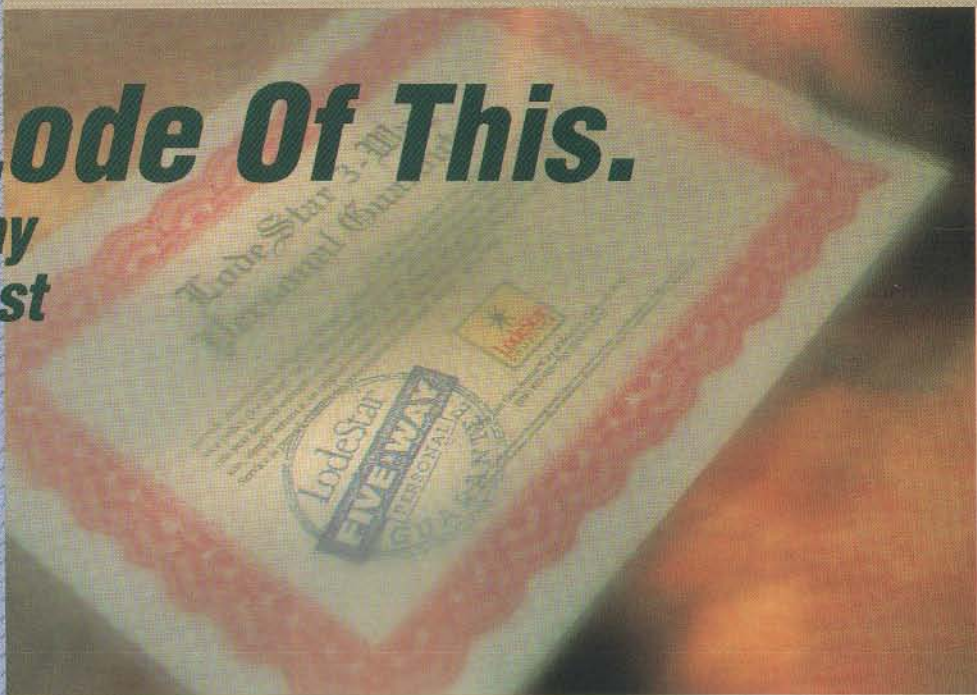

Modulless Upgradeables

Carry A Greater Lode In The Future



Easy and inexpensive upgrades are built right into your LodeStar Starflex computer. Unlike conventional modular upgradeable systems from other Companies, you can upgrade your LodeStar Starflex system at a fraction of the cost—all the way from 386DX to 486SX or 486DX, at any clock speed.

Thanks to our unique non-proprietary Modulless Upgrade design, LodeStar Starflex systems can be upgraded by simply plugging in the new chip and oscillator that comes in their inexpensive upgrade kit. Another bright idea from LodeStar-It's just that simple!

Every LodeStar computer is fully loaded with value. This includes unsurpassed quality throughout. To make certain of this, every system is individually pre-tested and burned-in for 72 hours prior to shipment. And of course, we stand behind our quality with our comprehensive Five-Way Personal Guarantee. You will see this quality all the way from our StarView SVGA Non-Interlaced Monitors with flicker-free image, to our own StarKey extended keyboards. And we pack in even extra value by pre-loading MS DOS 5.0 & Windows 3.0, as well as a Hi-Res 400 DPI serial mouse on every system. And our systems can be upgraded to include optional cache, RAM, more hard disk capacity, larger monitor, and a host of other enhancements you may require. Add it all together - stellar performance, brilliant quality, and guarantee that outshines all others - and you've got LodeStar.



- Warranty -
"One of the most conspicuous things that differentiate LodeStar from its competitors is extensive warranty support."

- Craftsmanship -
Layout is excellent..... Wonderfully uncramped sight that greets you when you open the case with LodeStar's tower, you don't have to fight a mass of tangled cables and jagged edges."

- Technical Support -
"As a further test of technical support, I deliberately destroyed..... I then gave the system and a phone to an inexperienced friend. A LodeStar technician competently took her through the process....."

- Prompt Response -
"When I called with a question..... I was immediately connected to a knowledgeable technician."

- Summary -
"The combination of high performance, low price, and one year of free on-site services makes LodeStar 486 an attractive buy." - PC Sources 1992

LodeStar 386-40C
\$1659

AMD 80386/40 Processor
 64K Cache RAM (Expandable to 256K)
 4MB RAM (Expandable to 32MB)
 125 MB IDE Hard Drive w/Cache
 Teac 1.2MB 5.25" & 1.44MB 3.5" Drives
 1 MB SVGA Non-Interlaced Color card
 14" StarView 1024 NI SVGA Monitor
 (VESA Std for 72 Hz Flicker-Free Display)
 2 Serial, 1 parallel, & 1 Game Port
 MS DOS 5.0 & MS Window 3.0 w/Manual
 Starkey 102 Keyboard
 Hi-Res Serial Mouse
 Desktop CPU case (Verticals optional)

StarFlex 386-40 Cache
 Upgradable Series

\$1769

Upgradable to 486SX-20, 486-33/50.

LodeStar 386SX-25
\$1179

Intel/AMD 80386SX 25 Processor
 2MB RAM & 42 MB Hard Drive w/Cache
 Teac 1.2MB 5.25" & 1.44MB 3.5" Drives
 1 MB SVGA Color card
 14" StarView 1024 x 768 Color Monitor
 (VESA Std for 72 Hz Flicker-Free Display)
 2 Serial, 1 parallel, & 1 Game Port
 MS DOS 5.0 & MS Window 3.0 w/Manual
 Starkey 102 Keyboard
 Hi-Res Serial Mouse
 Desktop CPU case (Verticals optional)

LodeStar 386SX-16
\$1139

Call For Our
 MultiMedia System

Circle 236 on Inquiry Card.

*Mid & Full Verticals may be additional on some systems.

LodeStar 386-33C
\$1629

Intel 80386/33 Processor
 64K Cache RAM (Expandable to 256K)
 4MB RAM (Expandable to 32MB)
 125 MB IDE Hard Drive w/Cache
 Teac 1.2MB 5.25" & 1.44MB 3.5" Drives
 1 MB SVGA Non-Interlaced Color card
 14" StarView 1024 NI SVGA Monitor
 (VESA Std for 72 Hz Flicker-Free Display)
 2 Serial, 1 parallel, & 1 Game Port
 MS DOS 5.0 & MS Window 3.0 w/Manual
 Starkey 102 Keyboard
 Hi-Res Serial Mouse
 Desktop CPU case (Verticals optional)

StarFlex 386-33 Cache
 Upgradable Series

\$1729

Upgradable to 40 Mhz & 486SX-20, 486-33/50

LodeStar 486-50C
\$2389

Intel 80486/50 Processor w/ 8K Internal
 Cache & Built-in Math Coprocessor
 2 x 32 Bit Local Bus Expansion Slots
 64K Cache RAM (Expandable to 256K)
 4MB RAM (Expandable to 32MB) 60ns
 125 MB IDE Hard Drive w/Cache
 Teac 1.2MB 5.25" & 1.44MB 3.5" Drives
 1 MB SVGA Non-Interlaced Color card
 14" StarView 1024 NI SVGA Monitor
 (VESA Std for 72 Hz Flicker-Free Display)
 2 Serial, 1 parallel, & 1 Game Port
 MS DOS 5.0 & MS Window 3.0 w/Manual
 Starkey 102 Keyboard
 Hi-Res Serial Mouse
 Vertical or desktop Case

486-50 CADstation
\$3759

8 MB RAM & 210 MB Hard Drive
 17" SVGA Color Monitor,
 32 Bit Local Bus SVGA Color Card
 (w/1 MB RAM & Provide 32,768 Colors)

LodeStar 386-25
\$1489

Intel 80386/25 Processor
 4MB RAM (Expandable to 32MB)
 85 MB IDE Hard Drive w/Cache
 Teac 1.2MB 5.25" & 1.44MB 3.5" Drives
 1 MB SVGA Non-Interlaced Color card
 14" StarView 1024 NI SVGA Monitor
 (VESA Std for 72 Hz Flicker-Free Display)
 2 Serial, 1 parallel, & 1 Game Port
 MS DOS 5.0 & MS Window 3.0 w/Manual
 Starkey 102 Keyboard
 Hi-Res Serial Mouse
 Desktop CPU case (Verticals optional)

StarFlex 386-25 Cache
 Upgradable Series

\$1629

64K Cache RAM (Expandable to 256k)
 Upgradable to 33/40 Mhz & 486SX-20, 486-33/50.

LodeStar 486-33C
\$2049

Intel 80486/33 Processor w/ 8K Internal
 Cache & Built-in Math Coprocessor
 2 x 32 Bit Local Bus Expansion Slots
 64K Cache RAM (Expandable to 256K)
 4MB RAM (Expandable to 32MB) 60ns
 125 MB IDE Hard Drive w/Cache
 Teac 1.2MB 5.25" & 1.44MB 3.5" Drives
 1 MB SVGA Non-Interlaced Color card
 14" StarView 1024 NI SVGA Monitor
 (VESA Std for 72 Hz Flicker-Free Display)
 2 Serial, 1 parallel, & 1 Game Port
 MS DOS 5.0 & MS Window 3.0 w/Manual
 Starkey 102 Keyboard
 Hi-Res Serial Mouse
 Mid Vertical or Desktop Case

486-33 WINstation
\$2679

8 MB RAM & 210 MB HD.
 32 Bit Local Bus SVGA Color Card
 (1 MB RAM & Provide 32,768 Colors)



18539 East Gale Ave.
 City of Industry,
 California, 91748
 Tel: 1.818.810 3818
 Tech Support:
 1.800.875.7569
 Fax: 1.818.810.5928

GOVERNMENT, SCHOOLS AND CORPORATE PURCHASE ORDERS WELCOME. All prices and specifications subject to change without notice. 2-Year Parts Warranty applies to LodeStar products only. Money Back Guarantee does not include shipping & handling, and all returns must be shipped pre-paid & in resalable condition. Please call to confirm all warranty details. Photography is for illustration only. No surcharge on VISA, MasterCard, & Discover. 2% cash discount on all Pre-Paid systems. Purchase orders are accepted on approved credit. California orders add 8.1/4% sales tax. All product names, trademarks and registered trademarks are the property of their respective companies. For more written information, please call for our FREE product catalog.

1.800.875.7568

ATronics' 50MHz 486 is. Computer Shopper January 1992

...TO DIE FOR!

ATronics offers you more for your hard-earned dollar. Highest quality components; customer service and technical support second to none. Systems designed to avoid obsolescence and protect your investment dollar. Motherboards designed with upgradeability in mind.

We've been first since 1985. The very first AT-compatible; the first 486 on the market. Dollar for dollar and feature for feature, no competitive system available today can match the ATronics line for technology, quality and value. You owe it to yourself to check our prices. Call us today!

"The price is spectacular... Its expandability is outstanding... Service and support rates high."
PC World, March 1992

"AT's 50MHz system has all the right components - plus a trick removable hard drive - at a 33MHz price."
Computer Shopper, Jan. '92

"This computer might well inspire love... with enough power to earn its keep in the office or at home."
PC Magazine, 1990 - '91

Systems Proudly Made in the USA!

ATI-386/33

- 33MHz 80386
- 64K cache
- 1MB DRAM
- 120MB IDE hard drive
- 1.44MB or 1.2MB drive
- 1024 X 768 SVGA card
- SVGA monitor (1024 X 768)
- 2 serial and 1 parallel port
- 101 enhanced keyboard
- Baby AT case

\$1,495

ATI-486/20SX

- 20MHz 80486SX
- 64K write back cache
- 4MB DRAM
- 120MB IDE hard disk
- 1.44 MB or 1.2MB drive
- 1024 X 768 SVGA card
- SVGA monitor (1024 X 768)
- 2 serial and 1 parallel port
- 101 enhanced keyboard
- Baby AT case

\$1,745

ATI-486/33DX

- 33MHz 80486DX
- 256K write back cache
- 4MB DRAM
- 120MB IDE hard disk
- 1.44 MB or 1.2MB drive
- 1024 X 768 SVGA card
- SVGA monitor (1024 X 768)
- 2 serial and 1 parallel port
- 101 enhanced keyboard
- Baby AT case

\$1,995

Quality: U.S. designed and made since 1985. On-Site Service: Available; Unlimited technical phone support included.

ATronics' 50 MHz 486 Systems

ATI-486/50DX2

- 50MHz 80486DX2
- 256K write back cache
- 4MB DRAM
- 120MB IDE hard drive
- 1.44MB or 1.2MB drive
- 1024 X 768 SVGA card
- SVGA monitor (1024 X 768)
- 2 serial and 1 parallel port
- 101 enhanced keyboard
- Baby AT case

\$2,395

ATI-486/50DX

- 50MHz 80486DX
- 256K write back cache
- 4MB DRAM
- 120MB IDE hard disk
- 1.44 MB or 1.2MB drive
- 1024 X 768 SVGA card
- SVGA monitor (1024 X 768)
- 2 serial and 1 parallel port
- 101 enhanced keyboard
- Baby AT case

\$2,495



ATronic International, Inc.

45635 Northport Loop
Fremont, CA 94538-6

Phone: 510-656-8

Fax: 510-656-8

Hours: 7 am to 5 pm PST

(OUTSIDE CALIFORNIA SALES CALLS)

1-800-488-77

Circle 199 on Inquiry Card.

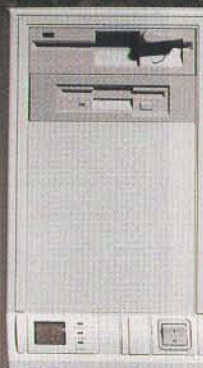

- All prices and specifications subject to change without notice.
- University and Corporate PC's welcome (\$% 10, Net 30).
- On Site Service available in most U.S. locations.
- All systems have been verified to comply with part 15 of the FCC rules for a Class A or B computers. FCC Class A not intended for home use.
- ATI is a registered trademark of ATronics International, Inc. Other trademarks belong to their respective companies.
- Intel Inside Logo is a registered trademark of Intel Corporation.
- Additional cache DRAM or optional full tower cases available.

Pick A Card

Volante

Draw
your
winning
card from
National
Design's
Volante Series



of high speed graphics boards.

All Volante high speed graphics boards offer:

- Built on ISA, MicroChannel or VME bus
- Video memory upgrades to 4 MB
- Program memory upgrades to 4 MB
- Razor sharp resolutions from 1024x768 up to 1600x1280
- Blazing color selection from 8-bit to 24-bit true color
- Optional TI TMS34082 floating point processor for enhanced 3D acceleration
- Superior speed of the TI TMS34020 graphics engine paired with National Design's advanced ASIC technology
- LIFETIME WARRANTY - no gamble here!

Whether your game is CAD, Microsoft Windows, graphic arts, multi-media or medical imaging, Volante has a card for you at a fraction of the cost charged by the competition.

Call 800-253-8831 now for information
on the breathtaking Volante series.
Phone: 512-343-5055 Fax: 512-343-5053



NATIONAL DESIGN, INC.
9171 CAPITAL OF TEXAS HWY. H-230
AUSTIN, TEXAS, 78759

Circle 219 on Inquiry Card (RESELLERS: 220).

CONTROL UP TO 96 PC FILE SERVERS WITH 1 KEYBOARD AND MONITOR USING... **COMMANDER**

by cybex



- **Select via Keyboard**
- **Dual access up to 250 feet away (optional)**
- **No external power**
- **Mix PC, PC/XT, PC/AT and PS/2**
- **"AutoBoot™" Feature boots attached computers without operator intervention**
- **Shows PC power status**

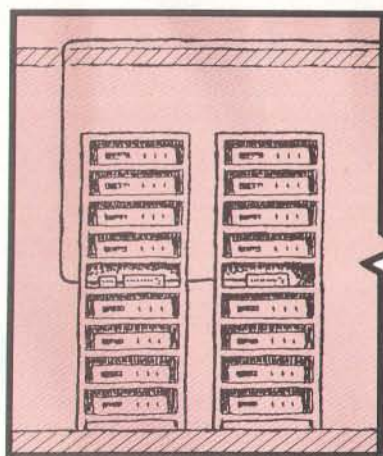
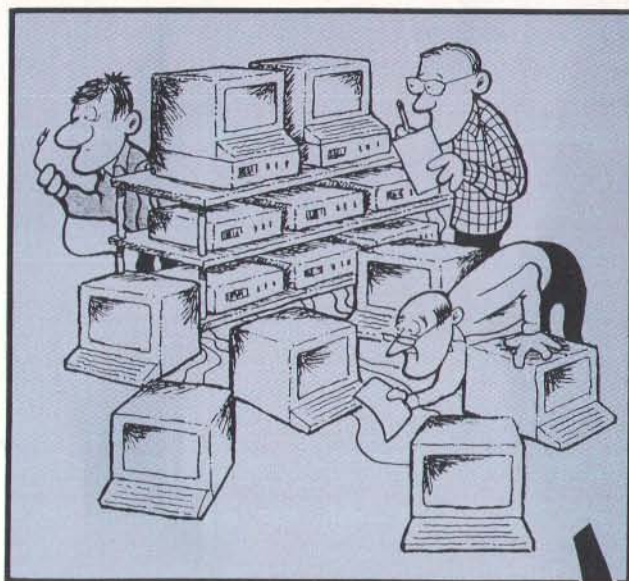

- **PS/2 Mouse support available**
- **Each unit accommodates from 2 to 8 PCs**
- **Up to 12 units can be cascaded**
- **Mounting kit available for 19" and 24" rack installation**

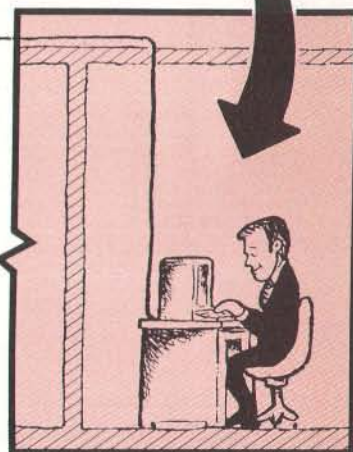

Dealer Program Available

Cybex Corporation

2800-H Bob Wallace Ave.
Huntsville, Alabama 35805.

(205) 534-0011

Fax (205) 534-0010

PC, PC/XT, PC/AT and PS/2 are trademarks of International Business Machines Corp.

**BUY
HDI**



**PC
MAGAZINE**
EDITORS'
CHOICE
June 27, 1989
Mass Storage Mail Order

HARD DRIVES AND PERIPHERALS

**NEW
LOWER
PRICES**

**WORRY-FREE
30
Day
REPLACEMENT
GUARANTEE**

**FOR THE BEST
PRICE, SERVICE
& SUPPORT
CALL:**

800/998-8040

A RECOGNIZED LEADER!

Quantum

- 52MB QULPS52A IDE**
17ms 3.5" 1"H
Bare Drive Kit **\$209**
16 Bit Kit **\$229**
- 105MB QULPS105A IDE**
17ms 3.5" 1"H
Bare Drive Kit **\$349**
16 Bit Kit **\$369**
- 210MB QUPRO210A IDE**
15ms 3.5" HH
Bare Drive Kit **\$649**
16 Bit Kit **\$669**

Seagate

- 42MB ST351A IDE**
28ms 3.5" 1"H
Bare Drive Kit **\$179**
8 Bit Kit **\$209**
16 Bit Kit **\$199**
- 60MB ST277R-1 RLL**
28ms 5.25" HH
Bare Drive Kit **\$249**
8 Bit Kit **\$299**
16 Bit Kit **\$319**

- 106MB ST3120A IDE**
18ms 3.5" 1"H
Bare Drive Kit **\$319**
8 Bit Kit **\$349**
16 Bit Kit **\$379**
- 130MB ST3144A IDE**
16ms 3.5" 1"H
Bare Drive Kit **\$359**
16 Bit Kit **\$379**
- 210MB ST1239A IDE**
15ms 3.5" HH
Bare Drive Kit **\$599**
16 Bit Kit **\$619**

- 1050MB ST41200N SCSI**
15ms 5.25" FH
Bare Drive Kit **\$2099**
16 Bit Kit **\$2249**



HDI SALES: 602/350-1128
FAX 602/350-1150

NATIONAL ACCOUNTS
Purchase Orders
800/998-8014
FAX 602/350-1180

International: 602/350-1144
FAX 602/350-1188

APO/FPO: 602/350-1145

Order Status: 800/729-4490

Talon

- 105MB SA3101A IDE**
16ms 3.5" 1"H
Bare Drive Kit **\$329**
8 Bit Kit **\$349**
16 Bit Kit **\$389**
- 120MB SA3062A IDE**
16ms 3.5" 1"H
Bare Drive Kit **\$379**
8 Bit Kit **\$399**
16 Bit Kit **\$399**

FUJITSU

- 513MB M2624T IDE**
12ms 3.5" HH
Bare Drive Kit **\$1199**
16 Bit Kit **\$1295**

- 1079MB M2266SA SCSI**
14.5ms 5.25" FH
Bare Drive Kit **\$2099**
16 Bit Kit **\$2299**

CONNER

- 40MB CP3000 IDE**
25ms 3.5" 1"H
Bare Drive Kit **\$189**
8 Bit Kit **\$219**
16 Bit Kit **\$199**
- 120MB CP30104 IDE**
16ms 3.5" 1"H
Bare Drive Kit **\$379**
8 Bit Kit **\$419**
16 Bit Kit **\$399**
- 209MB CP3204 IDE**
16ms 3.5" HH
Bare Drive Kit **\$609**
16 Bit Kit **\$629**

MICROPOLIS

- 340MB ESDI**
MC1664
15ms 5.25" HH
Bare Drive Kit **\$1099**
16 Bit Kit **\$1199**

- 1034MB SCSI**
HS MC1598
14ms 5.25" FH
Bare Drive Kit **\$2199**
16 Bit Kit **\$2299**

- 660MB ESDI SCSI**
MC1568/1588
16ms 5.25" FH
Bare Drive Kit **\$1499**
16 Bit Kit **\$1699**

- 1354MB SCSI**
HS MC1528
14ms 5.25" FH
Bare Drive Kit **\$2699**
16 Bit Kit **\$2799**

ALL BARE DRIVE KITS INCLUDE All mounting hardware, "Disk Manager" formatting/partitioning software if necessary, and HDI's Hard Drive Reference Manual with complete installation instructions.
COMPLETE INSTRUCTIONS - EVERYTHING YOU NEED!

ALL 8 & 16 BIT KITS INCLUDE 16-Bit host adaptor hard/floppy "1 to 1" controller or interface card, mounting kit (3.5" kit inc. beige & black bezels), rails, cables, all mounting hardware, "Disk Manager" software (if applicable) and manual.

SIMM

- ADD 1MB RAM AS LOW AS \$39**
- 1MB x9 80ns \$49**
 - 1MB x8 80ns \$39**
- Add \$2 for SIP
MEMORY FOR EVERY SYSTEM!

CD ROM DRIVES

- 600MB Internal External**
- TALON **\$299 N/A**
- SONY **\$389 \$509**
- CHINON **\$399 \$519**
- TOSHIBA **\$599 \$699**

**TOLL-FREE
TECHNICAL
SUPPORT**

**WE SHIP VIA
FEDERAL EXPRESS**



**NEVER A SURCHARGE
for VISA, MC or Discover!**



Prices and availability subject to change without notice. All items NEW. PO's accepted from qualified buyers-Net. 20. APO/FPO orders add \$13 shipping. 30 Day Guarantee & 1-Year Replacement Policy may have some restrictions. Shipping is not refundable. All trademarks are the properties of their respective owners. 6/92 c 1992 Insight Distribution Network, Inc.



Hard Drives International
Insight Distribution Network, Inc.
1912 W. 4th St., Dept. HAK
Tempe, AZ 85281

**ALWAYS LOW PRICES
SOFTWARE!**
SUPER LOW WITH PURCHASE
OF HARDWARE
Call for details.

HARD DRIVES International

800/998-8040

PURCHASE ORDERS/NATIONAL ACCOUNTS 800/998-8014

**HARD DRIVES
International**

Another
Insight
Company

Insight

HAK

GOOD MEMORIES

H.Co. has America's largest selection of memory!
And, we'll beat any USA advertised price.*



Memory is Cheap-but Only
If you Know Where to Look.
The Phantom Saves a
Bundle on SIMMS. Truth in
advertising--what a concept...
PC Computing, April 1992

Math Coprocessors

IIT Up to 50% Faster

Part #	Price
2C87-20	\$99.00
3C87SX-16	129.00
3C87SX-20	139.00
3C87SX-25	149.00
3C87-25	169.00
3C87-33	179.00
3C87-40	199.00



intel

Part #	Price
80487SX-20	\$509.00
80387/33/25	219.00
80387SX-20	159.00
80387SX-16	149.00
80287XL/XLT	109.00

Gyrix

Part #	Price
83S87-20	\$149.00
83S87-25	159.00
83D87-25	179.00
83D87-33	189.00
83D87-40	219.00

Laptop Memory

TOSHIBA		NEC	
Memory	Price	Memory	Price
T1000SE, XE, LE & 2000SX	1MB Kit \$149.00	UltraLite	1MB MD \$229.00
	2MB Kit 199.00	286F	4MB MD 599.00
	4MB Kit 319.00	Prospeed	1MB BD 159.00
	8MB Kit 679.00	SX/20	4MB BD 439.00
T1200XE	2MB Kit 119.00	Prospeed	1MB BD 139.00
T1600	2MB Kit 119.00	286	4MB BD 259.00
T3100SX	2MB Kit 119.00	386SX/16	2MB BD 399.00
	4MB Kit 209.00	Prospeed	2MB CD 259.00
	2MB Kit 279.00	386	8MB CD 999.00
T3100e	2MB Kit 119.00		
T3200/SXC	2MB Kit 119.00		
	4MB Kit 209.00		
	2MB Kit 119.00		
	4MB Kit 209.00		
T3200	3MB Kit 229.00		
T5100	2MB Kit 119.00		
T5200, 5200C	2MB Kit 119.00		
8500	8MB Kit 429.00		

IBM

Memory	Price
L40SX	2MB Mem. \$119.00
	4MB Mem. 219.00
	8MB Mem. 449.00

COMPAGQ

Memory	Price
Portable III	2MB Kit \$129.00
Portable 386/20	1MB Kit 179.00
	4MB Kit 459.00
Portable	1MB BD 119.00
LTE286	2MB BD 149.00
	4MB BD 459.00
Portable	1MB BD 179.00
LTE386S/20	4MB BD 359.00
	1MB BD 129.00
SLT7286	4MB BD 429.00
	1MB BD 139.00
SLT7386	2MB BD 219.00
	4MB BD 399.00

ZENITH

Memory	Price
2MB Alpha	.. \$169.00
2MB Beta	.. 169.00
2MB EXP	.. 189.00
1MB MD	.. 189.00
4MB CD	.. 429.00
1MB BD	.. 159.00
4MB BD	.. 495.00

OTHERS

Memory	Price
AST Ext. Notebook	1MB SIMM \$79.00
Sharp	4MB SIMM 209.00
PC-6220 Notebook	1MB BD 129.00
TI T.M. 2000	2MB Kit 129.00
TI T.M. 3000	2MB Kit 129.00
Everex	2MB MD 199.00
Templ LX	1MB CD 129.00
Panasonic CF-170,270	1MB UPG 159.00
Epson NB3S	4MB UPG 399.00

DeskTop Memory Upgrades

Apple Memory Added	Price	IBM Works w/Model	Memory Added	Price
Mac Classic	1-3MB BD ... \$89.00	50Z,55SX,70-E61, 1MB	\$ 59.00
	2MB Kit 89.00	70-121,P-70		
Mac IIc,IIsi	1MB Kit 69.00	50Z,55SX,70-E61, 2MB	109.00
Mac IIsi	2MB Kit 159.00	70-121,P-70		
Mac Icl,IIl	4MB Kit 209.00	55SX,65SX,55LS, 4MB	239.00
Mac IIsi	8MB Kit 499.00	34F3077		
Mac Icl,IIl	16MB Kit 629.00	70-A21,A61,B21, 2MB	119.00
Mac IIfx	4MB Kit 199.00	B61		
Mac SE,SE 30, Plus, II, IIfx,IIx	4MB Kit 199.00	30/286	2MB	99.00
			2MB	119.00
			PS/1	
			80-041	1MB 79.00
			80-111,31	2MB 139.00
			80-A21,A31,A61	4MB 239.00
			90,95	4MB 259.00
			70,80	2MB BD ..299.00
			50 & 60 Series	2MB BD ..249.00
			50 & 60	2MB BD ..249.00
			PS/2 Model 57SX,90,95	8MB MD .. 499.00

AST

Memory	Price
Bravo 486/25	2MB Kit \$119.00
	8MB Kit 409.00

Prem 386/SX16 & 20, 25, 33

Memory	Price
8MB Kit 409.00

Prem II SX/20

Memory	Price
1MB Kit 59.00
4MB Kit 219.00

Cupid Exp. Premium 386C

Memory	Price
1MB Kit 59.00

WKST & Bravo Premium

Memory	Price
286
Fastram	512-2MB BD ..289.00
FastramKit	512 Upg. 55.00
Premium	1MB Kit 59.00
386	4MB Kit 249.00

COMPAGQ

Memory	Price
DP 386/33,486/25,33 & Systemp	8MB MD 395.00
DP 386/20e,20 & 25e,25	1MB BD 139.00
	4MB BD 299.00
	1MB MD 89.00
	4MB MD 209.00
DP-386 S/16	1MB BD 119.00
	4MB BD 299.00
	1MB MD 89.00
	4MB MD 209.00
DP 286N, 386N, & 386SX/20	1MB MD 69.00
	2MB MD 109.00
	4MB MD 249.00
	OK BD 99.00
DP 386/16	1 MB BD 279.00
	4 MB BD 599.00
	8 MB BD 899.00

NEC

Memory	Price
P.M SX+	1MB BD \$189.00
	4MB BD 579.00
	8MB BD 1,099.00
P.M SX/20	2MB CPU 189.00
	UPG.
	2MB 269.00
	UPG. & Exp.
	2MB 119.00
	UPG. Kit 149.00
P.M SX/16	2-8 MB 249.00
	Exp.
	2MB 149.00
	UPG. Kit 149.00
P.M 386/20	2MB MD 349.00
	8MB MD 999.00

P.M 386/25S

Memory	Price
2MB Kit 199.00
8MB Kit 659.00

P.M 386/25

Memory	Price
2MB MD 349.00
8MB MD 859.00
8MB 1,199.00
Repl BD

P.M 386/33E&486/25E

Memory	Price
2MB MD 279.00

ZENITH

Memory	Price
Z-386/20,	1MB SM \$ 69.00
25,33,33e	2MB SM 129.00
	4MB SM 259.00
Z-386SX,	2MB SM 119.00
286-LP+, Z-L5	
Mastersport SL	
	2MB MD 199.00

CALL FOR RISC SYSTEM 6000 MEMORY!!

AST

Memory	Price
2MB Kit \$119.00
8MB Kit 409.00

COMPAGQ

Memory	Price
DP 386/16	1 MB BD 279.00
	4 MB BD 599.00
	8 MB BD 899.00

ZENITH

Memory	Price
Z-386/20,	1MB SM \$ 69.00
25,33,33e	2MB SM 129.00
	4MB SM 259.00
Z-386SX,	2MB SM 119.00
286-LP+, Z-L5	
Mastersport SL	
	2MB MD 199.00

CALL FOR RISC SYSTEM 6000 MEMORY!!

AST

Memory	Price
2MB Kit \$119.00
8MB Kit 409.00

COMPAGQ

Memory	Price
DP 386/16	1 MB BD 279.00
	4 MB BD 599.00
	8 MB BD 899.00

ZENITH

Memory	Price
Z-386/20,	1MB SM \$ 69.00
25,33,33e	2MB SM 129.00
	4MB SM 259.00
Z-386SX,	2MB SM 119.00
286-LP+, Z-L5	
Mastersport SL	
	2MB MD 199.00

CALL FOR RISC SYSTEM 6000 MEMORY!!

AST

Memory	Price
2MB Kit \$119.00
8MB Kit 409.00

COMPAGQ

Memory	Price
DP 386/16	1 MB BD 279.00
	4 MB BD 599.00
	8 MB BD 899.00

ZENITH

Memory	Price
Z-386/20,	1MB SM \$ 69.00
25,33,33e	2MB SM 129.00
	4MB SM 259.00
Z-386SX,	2MB SM 119.00
286-LP+, Z-L5	
Mastersport SL	
	2MB MD 199.00

Laser Printer Memory

Model	Memory Added	PRICE
H.P.Laserjet IIP, III,IIID,IIIP	1MB Module	\$ 85.00
	2MB Module	119.00
	3MB Module	179.00
	4MB Module	209.00
H.P.Laserjet II,IIID	1MB Module	85.00
	2MB Module	119.00
	4MB Module	209.00
H.P.Laserjet IIIsi	1MB Module	69.00
	4MB Module	189.00
H.P.Deskjet	256K Module	109.00
IBM 4019,4019e	1MB Module	99.00
	2MB Module	139.00
	3.5MB Module	219.00
OKI Laser 400	1MB Module	109.00
	2MB Module	149.00
OKI Laser 800,820	1MB Module	109.00
	2MB Module	149.00
	4MB Module	199.00
Panasonic 4450	1MB Module	160.00
Panasonic 4420, 4450i	1MB Module	99.00
	2MB Module	149.00
	4MB Module	249.00

Chips/SIMMs

STANDARD SIMMS		DRAM	
PART#	PRICE	PART#	PRICE
256X8-10\$17.00	1X1-80\$4.95
256X9-8015.00	256-801.80
1X8-8043.00	256-702.00
1X9-8043.00	256X4-805.00
1X9-7045.00	4464-802.50
4X9-80169.00	4464-102.00
4X8-80159.00		

KINGSTON

Convert your 286 to a 386
The SX/NOW Works with most:

IBM, AST, Compaq, Epson, HP, NEC, AGI

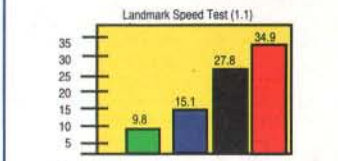

PS/2 Model 50/60
PS/2 Model 65SX
PS/2 Model 50/60 + 20MHz SX Now!
PS/2 Model 50/60 + 25MHz SX Now!

KINGSTON SX/NOW CPU Upgrades

Configuration	Price
20 Mhz \$345.00
25 Mhz 395.00

All Products
100%
Guaranteed!

PURCHASE ORDERS ACCEPTED
from universities, government & qualified firms!
International orders & FAX orders accepted

H.Co.
Computer Products
17922 Sky Park Circle #F
Irvine, CA 92714

Orders 1-800-726-2477
Tech Support 1-714-833-3364
Information 1-714-833-3222
FAX 1-714-833-3389

Germany Office: ThomasBohlmann
Charlottenburgerufer 18, 1000 Berlin 10
TEL: 030/3410478 FAX: 030/3426310

OPEN WEEKENDS



* H.Co. will meet any U.S.A. legitimately advertised price on MEMORY products only from companies with new merchandise actually in stock. Offer excludes Chips and SIMMS. Trademarks are the property of their respective companies. Prices are subject to change. 1992 H.Co. Computer Products.

Circle 210 on Inquiry Card (RESELLERS: 211).

POWER to SHARE

with Printer Sharing Solutions from Buffalo Products

Now your work group can share expensive printing equipment. Each member of your team can have access to the maximum printing power of the whole group. Using Buffalo Products peripheral sharing devices, each PC can be connected to all of your output devices. Expensive, high-powered peripherals (like high performance laser printers and plotters) can be shared by everyone.



Advanced Features + High Quality + Low Cost = Industry Leader

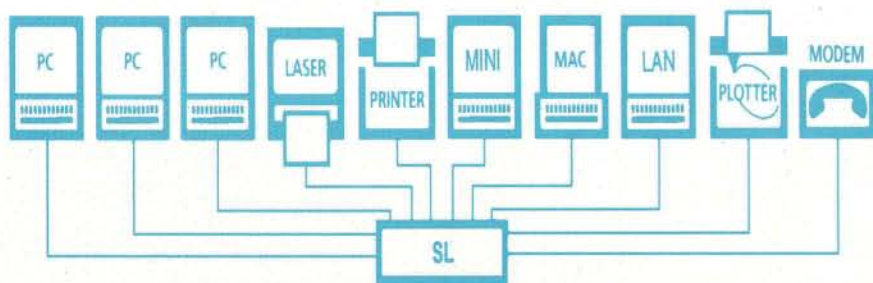

Buffalo Box Features:

- Pop-up Menu & Windows Option
- Easy Installation & Use
- Rapid Data Transfer
- User Upgradable Memory
- Reliable Automatic Switching
- No PC RAM Memory Required
- Toll-Free Application Consulting
- Toll-Free Technical Support
- 45-Day Money-Back Guarantee

Model	Ports	PCs/ Printers	Memory Available	Priced From
SL	6 Ser/4Par	Any Combination	256KB-4MB	\$495
SLP	8 Par/2 Ser	Any Combination	256KB-4MB	\$495
HXS	4 Serial	Any Combination	256KB-16MB	\$295
HXM	2 Ser/ 2 Par	Any Combination	256KB-16MB	\$295
HWP	5 Parallel	3/2, 4/1	256KB-16MB	\$295
HXP	4 Parallel	2/2, 3/1	256KB-16MB	\$245
HCP	2 Parallel	1/1	256KB-16MB	\$225
AS31	4 Parallel	3/1	None	\$175
AS41	5 Parallel	4/1	None	\$195
AS81S	9 Ser/ 1 Par	8/1	None	\$79

BUFFALO

**US and Canada Toll-Free
(800) 345-2356**

FAX (503) 585-4505
Buffalo Products, Inc.

2805 19th St. SE, Salem, OR 97302-1520

NO WILD, NO WILDLIFE.

PHOTO: TOM & PAT LEESON

Life in the wild can be pretty tough these days. Without the necessary ancient-forest habitat to live in, some species like the northern spotted owl of the Pacific Northwest are severely threatened.

At the Sierra Club, we believe that these owls and the ancient forest ecosystems they depend on need our help. The Sierra Club's work to permanently protect our ancient forests also helps preserve the habitat of the northern spotted owl, giving

them the range they need to help their population grow.

To learn more about our work protecting the forest habitats of endangered species such as the northern spotted owl, please write us at:



Sierra Club
Dept. PB
730 Polk Street
San Francisco, CA 94109
(415) 776-2211

CyberResearch June Product Showcase

VGA to your VCR



Tape VGA Animation

Redlake TapeCaster VGA to Video Converter

Redlake's **TapeCaster** converts VGA screen output to video for applications such as animation and creating training tapes. The TapeCaster is extremely easy to use: no base addresses, no interrupts, no software — just plug and play.

- True, precise NTSC or PAL video timing.
- Simultaneous VGA and video display.
- Composite Video & Y-C (SuperVHS) output for use with equipment ranging from an inexpensive VCR to broadcast-quality professional video.

- #NTSC 200 TapeCaster – NTSC Video Output.....\$750
- #PAL 200 TapeCaster – PAL (Europe) Video Out. ...\$750
- #NTSC 100 NTSC Video Digitizer w/software\$1650

Circle 229 on Inquiry Card.

DAC 812: Eight Precision D/A's

Brand new from **Analog Corp.**, the **DAC 812** is a low-cost D/A (Analog Output) board designed for use in many different applications. Each of the 8 D/A channels



can be independently configured for one of 5 jumper-selectable ranges or for 4-20mA current-loop output. Channels may be sequentially or simultaneously updated, with all channels resetting to 0V (or 4mA) on power up.

24 Digital I/O lines are built into the **DAC 812** which may be used for TTL-level applications.

Software driver libraries in Microsoft C & Turbo C and a calibration utility are provided with the board, along with a user-friendly setup program to make getting started with the **DAC 812** easy.

An optional Screw Terminal Panel in a rugged RFI-Shielded hard plastic box is available as an accessory, complete with 2-meter shielded cables.

- #DAC 812 8-Channel 12-Bit Analog Output Bd.....\$599
- #DAC 812B Rugged, RFI Terminal Box w/Cables\$400

Circle 230 on Inquiry Card.

New Compression, Conversion and Communications Package

Lead Technologies' **LEADVIEW** combines image compression, file conversion, and communication in an easy-to-use hardware & software package.

- Extended Compression Ratios of up to 255:1
- Supports JPEG compression, JFIF, and JTIFF
- Uses C-Cube CL550B Image Compression Chip
- You can compress, convert, scale, and resize TGA, GIF, TIFF, PCX, BIN, and BMP files

#LTI 255 **LEADVIEW 255™**— Image Compression S/W & Real-Time Processing Board\$1995

(Compr. or Decmpr. 1 MB Targa file to 6KB in 1 Sec)

#LTI 200 **LEADVIEW™**— Turbo Software\$785

(1 MB Targa32 file to 6KB in 8 to 10 Seconds)

#LTI 100 **LEADVIEW™**— Software only.....\$129

(1 MB Targa32 file to 6KB in < 30 Seconds)

#LTI 110 **LEADVIEW™**— 30-Day Demo Version\$10

Circle 231 on Inquiry Card.

IEEE-488 Controllers from Keithley/Metrabyte

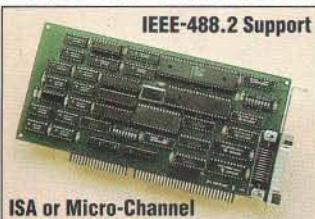

IEEE-488.2 Support

The **KPC 488AT** GPIB Controller card can be used to control and acquire data from up to 15 devices with IEEE-488 interfaces. (Up to 4 cards per PC, to control & monitor up to 60 devices from one computer.)

The **KPC** series boards support the new IEEE-488.2 extended protocol to make programming easier, while maintaining full compatibility with the older IEEE-488.1 standard.

- Data Transfer Rates to 1.5 MB/sec.
- DMA for High-Speed Data Transfers
- ISA, EISA, or Micro-Channel Bus
- Call Driver Software included FREE
- #KPC 488AT GPIB (IEEE-488.2) Interface for ISA/AT or EISA Computers.....\$495
- #KPC 488MC GPIB (IEEE-488.2) Interface for Micro-Channel PS/2 PC's\$450
- #KPC 488SW Co-Operator Software Developer Toolkit & Instrument Library. \$249

Circle 232 on Inquiry Card.

Elma Rack-Mount Keyboards

If you use a standard keyboard with your rack-mount system, you know what a nuisance and a hazard it can be. These industrial keyboards are designed to fit easily into any EIA 19" rack. Rugged and reliable, these keyboards are made in the U.S.A. by a Swiss electronics company & demonstrate classic Swiss craftsmanship.



OIX 6010

- 101-key layout & full-travel construction with tactile feel for touch-typing
- #OIX 3010 drawer-mounted / #OIX 6010 (shown) slides out with locking door
- Occupies only 1 rack space (1.75" high)

#OIX 3010 Low-cost, Drawer-Mounted Rack-Mount Keyboard.....\$295

#OIX 6010 Slide-out, Rack-Mount Keyboard w/locking drawer.....\$395

Circle 233 on Inquiry Card.

Your One-Stop Source for Rack-Mount PC's

CyberResearch carries the broadest line of rack-mount and industrial computers. Now we've added new models with built-in VGA monitors. You get a compact unit with '386 or '486 power and a color display.



Optional Rack-Mount Keyboards Also Available

- Built-In 10" VGA Color Monitor & VGA Card
- 4 Megabytes of RAM (2MB for VRC 386-16S)
- Enhanced 101-Key Keyboard
- 1.2MB Floppy Drive (or 1.44/3.5" if preferred)
- 2 Serial RS-232 Ports & 1 Parallel Port
- DOS 3.3 Software (or DOS 5.0, if preferred)

#VRC 386-16S VGA Rack-Mount PC, 80386sx, 16MHz, 2MB RAM\$2995

#VRC 386-33 VGA Rack-Mount PC, 80386, 33MHz, 4MB RAM.....\$3695

#VRC 486-33E VGA Rack-Mount EISA PC, 80486, 33MHz, 4MB RAM\$5595

#VRC 486-50E VGA Rack-Mount EISA PC, 80486, 50MHz, 16MB RAM\$Call

Circle 234 on Inquiry Card.

FREE PC Systems Handbook for Scientists & Engineers

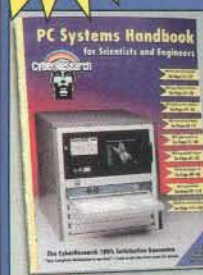

This Combination Tutorial/Catalog Includes Many Examples of PC-based Systems

The CyberResearch *PC Systems Handbook for Scientists & Engineers* describes over 1400 unique and hard to find items for PC-based engineering. Packed with useful technical information and easy-to-read diagrams, this invaluable reference should be part of every engineer's library.

Fax, Call, or Write for a complimentary copy.

Circle 234 on Inquiry Card.

The CyberResearch Advantage:

- ✓ FREE Application Engineering
- ✓ Everyday Low Prices
- ✓ Broadest Product Selection
- ✓ 100% Satisfaction Guarantee



Mailing Address:
P. O. Box 9565
New Haven, CT 06535

Worldwide
(203) 483-8815
Fax: (203) 483-9024

TOLL-FREE (800) 394-3300



Notice to International Customers

You can buy direct from CyberResearch and **save 50% or more!** A majority of the leading brands of PC-based engineering products are available for export from CyberResearch at the same low prices as those enjoyed by our customers in the United States.

Due to contractual restrictions, products from some manufacturers are not available for export to certain countries.

Please fax a request for quotation listing brand and/or performance requirements, and we'll fax back a prompt response.

Circle 234 on Inquiry Card.

SAVE BIG ON COMPUTER PRODUCTS

EXTRA CHARGE for credit cards

DRIVES AND BACKUPS

Conner Hard Drives			
3000	42MB	3.5" IDE 28ms	\$209
30104H	120MB	3.5" IDE 19ms	399
3204F	212MB	3.5" IDE 16ms	599
Seagate Hard Drives			
ST351AX	40MB	IDE 3.5"	199
ST238 RLL	30MB	RLL XT w/Cont.	239
ST251-1	40MB	28ms 1/2 HT	249
ST3096A	89MB	IDE 3.5" 14ms	319
ST3120A	100MB	3.5" IDE	349
ST3144A	130MB	IDE 3.5" 16ms	399

Micropolis			
1355	159MB	ESDI FH 23ms	469
1664	345MB	ESDI HH 18ms	999

Plus Development Hard Drive Cards			
Hard Card IXL	50MB / 105MB		CALL

Mountain Tape Backups			
FS4000 40/120MB AT Int.			\$249
FS4000 40/120MB AT Ext.			499
FS8000 80/250MB AT Int.			499
FS8500 80/304MB AT IDE Int.			569

Irwin Tape Back-Up			
Accutrak 120MB Internal Drive			179
Accutrak+ 120MB External Drive			309
Accutrak+ 120MB Internal Drive			239
Accutrak+ 250MB Internal Drive			299
Sony CD-ROM			
7205 XT. AT w/Laser Library			569

Includes: Compton's Family Encyclopedia, Languages of the World, Toolworks, World Atlas and more...

FLOPPY DRIVES			
Toshiba Disk Drive Kits			
ND 04D 5.25" 1/2 HT 360K (PC/XT)			\$59
ND 08DEG 5.25" 1.2MB (PC/AT)			69
ND 356T 3.5" 1.44MB AT Kit			69
Sony Disk Drives			
3.5" 720K (PC/XT/AT)			59
3.5" 1.44MB Slimline Bare			59
3.5" 1.44MB			59

MONITORS			
Panasonic 14" Color	1024 x 768		
C1381i (.28mm)			\$349
Packard Bell 14" Color			
8551VG VGA	640 x 480 (.51mm)		199
8539VG VGA	640 x 480 (.39mm)		245
8528SVGL EVGA	1024 x 768 (.28mm)		349
8548SVGL EVGA	1024 x 768 (.28mm)		369
Packard Bell Multisync Color (31mm)			
8517 SVGL 17"	1280 x 1024		999
8520 SVGL 20"	1280 x 1024		1499
NEC Multisync Color			
2A 14" 800 x 600			399
3FG 15" 1024 x 768			659
4FG 15" 1024 x 768			775
5FG 17" 1280 x 1024			1499
5D 20" 1280 x 1024			1699
6FG 21" 1280 x 1024			2999
Sony 14" Color			
1304HG 1024 x 768 Multisync			CALL
1320 640 x 480 VGA			349

JOYSTICKS			
Etronics Super Shooter Joystick			\$10.99
Etronics Wotta-Shootat Joystick			10.99
Gravis Analog Joystick			31.99
Gravis Eliminator Game Card			24.99

MICE			
Etronics Smartee Mouse			\$25.00
IMS1 Pet Mouse			19.99
Logitech Mouseman Combo			69.99
Logitech Dextra Mouse			19.99
Logitech First Mouse Serial			39.99
Logitech Trackman Serial			69.99
Logitech Portable Trackman			99.00
Microsoft Ballpoint for Laptops			119.99
Microsoft Serial Mouse w/Wind.			149.99
Microsoft Mouse Serial/Bus			79.99
Mouse System Omnimouse II w/Print Bus/Serial			49.99/35.99

DIGITIZERS			
Summagraphics SummaSketch II			\$299.99
Summagraphics SummaSketch Professional 18 x 12			599.00
Kurta 12 x 12 XLP Digitizer			249.99
Kurta IS/One 12 x 12 corded or cordless			359.99

SCANNERS			
Logitech Scanman 256			\$279.99
Panasonic Flatbed I, II, and III			CALL
Epson Desktop Color Scanner			899.00

CORPORATE CUSTOMERS INVITED
 We offer large bid opportunities. DUNS # 09-718-0517
OPEN ACCOUNTS-Net 30 terms available to D&B accounts rated 2A1 or better. Actual freight charges FOB Skokie, IL. Phone (as indicated) or fax orders to: Corporate Accounts, 708-677-7168. Mail P.O.'s (as indicated) to Dept. C1132.
PREPAID ACCOUNTS-Use Visa, MasterCard, check or money order (no cash or c.o.d.'s please). When ordering by mail please call in advance for shipping and handling charges. Shipments to IL add 7.75% tax. Minimum order \$15.00. 6/92 Write for FREE catalog.

PACKARD BELL COMPUTERS

THESE PACKARD BELL SYSTEMS INCLUDE:
 • 2 Floppy Drives • Enhanced 101 Keyboard
 • 2-Button Mouse • Tutorial • DOS 5.0 • QBasic

Monitor not included

1 Year Warranty
 * Carry-In
 ** On-Site

PACKARD BELL America grew up listening to us. It still does. Not affiliated with any former Bell System entity.				
FORCE	\$16K	\$20K	\$20XH	486SX
Processor	80386SX-16	80386SX-20	80386SX-20	80486SX-20
Hard Drive	85MB	107MB	130MB	105MB
Stand. RAM	2MB	4MB	4MB	4MB (8K Cache)
Max RAM	4MB	4MB	4MB	32MB (128K Cache)
Expansion Slots	3 16-BIT			4 16-BIT
Video Support	800 X 600 (256K) Memory			1024 X 768 (512K)
I/O Ports	1S, 1P, 1M, 1G, 1VGA, 1KB			2S, 1P, 1M, 1VGA, 1KB
ELEK-TEK Price	\$899	\$1099	\$1299	\$1675

2400B Internal Modem with S20X, S20XH & 486SX. Windows with S20X, S20XH & 486SX

Packard Bell 14" Color Monitors			
8551VG	8539VG	8528SVGL	PB Monitors Warranty: 1 year on-site when purchased with a PB force system (limit 1 per system) Purchased separately: carry-in or mail-in 1 year warranty.
640x480 (.51mm)	640x480 (.39mm)	1024x768 (.28mm)	
\$199	\$245	\$349	

386SX-20MHz	• 80C386SX/20MHz	• 640 x 480 VGA	• MS Windows
NOTEBOOK COMPUTER	• 60MB Hard Drive	• Ports: 1S, 1P, 1M, 1VGA, 1 Ext. FDD	• 1 Year Depot Warr.
	• 2MB RAM exp. 8MB	• MS-DOS 5.0 w/QBasic	\$1499

MATH COPROCESSORS

Intel Math CoProcessors			
80387	(5MHz)		\$85.00
80872	(6/8 MHz)		119.00
80871	(10MHz)		159.00
80287XL	(6,8,10MHz)		
and 80C287 (12MHz)			79.99
80287XLT Compaq LTE/286, and Tandy 2800			79.99
80387SL	(16/20/25MHz)		119.99
80387SX	(16MHz)		119.99
80387SX	(20MHz)		119.99
80387SX-25(25MHz)			119.99
80387	(16/20/25/33MHz)		199.00
80487SX	(20/25MHz)		459.00
Cyrix Math CoProcessors			
82587	(8-20MHz 80286)		75.00
83D87-25	(16/20/25MHz)		155.00
83D87-33	(33MHz 80386)		165.00
83D87-40	(40MHz 80386)		199.00
83587-16	(16MHz 80386SX)		95.00
83587-20	(20MHz 80386SX)		109.00
83587-25	(25MHz 80386SX)		119.00

CHIPS AND SIMMS

256K (all speeds)	CALL
1MB (all speeds)	CALL
Simms Modules (all speeds)	CALL
Sipps (all speeds)	CALL

ACCELERATOR/UPGRADE BOARDS

Solo	
286i/386i Accelerator	\$175/249
Express 386SX 16MHz Upgrade	259
Express 386SX 20MHz Upgrade	279
Express 386SX 25MHz Upgrade	325
I/O - II Drive Controller	89

TRONICS	
2400 Baud Internal w/software	\$49
2400 Baud Internal w/V.42 & software	95
2400 Baud External no software	69
2400 Baud External w/V.42 no software	119
NEW 9600 Baud Internal w/V.42 & software	249
NEW 9600 Baud External w/V.42 no software	259

DISKETTES					
	ELEK-TEK	MAXELL	SONY	3M	Verbatim
3 1/2" DSDD	\$6.50	\$7.99	\$7.99	\$8.50	\$7.99
3 1/2" DSHD	10.99	12.99	12.50	13.99	11.99
5 1/4" DSDD	3.99	5.99	4.99	5.99	5.50
5 1/4" DSHD (IBM AT)	6.99	8.50	8.99	9.50	8.99

In addition to the above, we stock preformatted & color diskettes.					
3M DATA CARTRIDGES					
Regular					
DC100A(Mini)	\$14.99	DC1000(Mini)	\$14.50	DC600 HC/lotomat™	\$25.50
DC300XL/P	20.00	DC2000(Mini)	14.99	DC6150/Zetamat™	28.00
DC600A	21.00	DC2080 (Mini)	19.50	DC2000/Koppamat™	19.00
DC6150	22.00	DC2120 (Mini)	20.99	DC2000/Thematat™	19.00
DC6250	26.99	DC21 35G Magnus	36.99	DC2080/Rhomat™	20.99
DC6320	29.00	2000 Tape		DC2120/Rhomat™	25.50
DC6525	34.00	Drive Cleaner	19.99	DC2120/Ximat™	25.50

Call for Large Quantity Pricing. Call for Wholesale Pricing on 3M Computer Tape.

SOFTWARE

386 Max	\$59.99	Fox Grabber	\$104.99
Adobe Type Manager V2.0	59.99	Letter Perfect	94.99
After Dark for Windows V2.0	26.99	Make Up for Windows	69.99
Bodyworks	39.99	Mavis Beacon Teaches Typing	30.99
Carbon Copy Plus 1	19.99	PC Anywhere V4.5	124.99
Central Point Antivirus	57.99	Force	124.99
Central Point Backup V7.1	59.99	ProCom Plus Q&A V4.0	63.99
Close Up Dual Back (Cast/Support)	129.99	Quatro Pro V4.0	329.99
The FarSide Computer Calendar for DOS	49.99	QEMM 386 V6	58.99
Fastback for Windows	89.99	WinFax Pro	74.99
		WordPerfect for Windows	279.99
		XTREE Gold	93.99

We Stock 2500 Other Software Titles

"Complete Line Of"
EPSON Panasonic
 Office Automation
 & **OKIDATA**
 Dot Matrix & Laser Printers
 Call For Our Low, Low Prices.™

Genuine Laser Toner Cartridges

HP92275 - LaserJet IIP/II/III	\$59.99
HP92285 - LJ/LJ+/LJ 500+	81.99†
HP92295 - LaserJet II/IIID/III/IIID	79.99†
HP92291 - LaserJet IIISI	107.99†
† Quantity Discounts Available	
Trays	
Lower Cassette IIP/II+/III/IIID	\$135
Letter†† / Legal Size†† IIP/II+/III/IIID	49 / 59
Envelope Tray†† IIP/II+/III/IIID	65
Letter / Legal Size II/IIID/III/IIID	52 / 60
Envelope Tray II/IIID/III/IIID	70
Letter Size IIISI / Legal Size IIISI	95 / 95
Executive Size IIISI	95
†† Requires Lower Cassette	
Memory Boards	
1MB Memory IIP/II+/III/IIID	149.00
2MB Memory LJ IIP/II+/III/IIID	249.00
1.5MB Memory LaserJet IIISI	115.00
256K DeskJet Plus / DeskJet 500	129.00
DeskJet / DeskJet Plus Ink Cartridges	14.50
DeskJet High Capacity Cartridge	23.99

HP LASERJET ENHANCEMENTS

25-IN-1 Font Cart. II/IIP/II+/III/IIID	CALL
25-IN-1 Font Cart. DeskJet 500/Plus	\$99
1MB Memory Board IIP/II+/III/IIID	99
2MB Memory Board IIP/II+/III/IIID	149
Postscript Cart. for IIP/II+/III/IIID	299

MODEMS AND FAX BOARDS

Internal Hayes	
2400 Baud with Software	\$239
9600 Baud V.42 w/Software	499
External Hayes (with software)	
2400 Baud Smartmodem	279
2400 Baud Pocket Edition	119
9600 Baud V.42/Ultra 96	499/649
Hayes Optima 2400/9600 Ext.	145/354.99
Internal Hayes Compatibles (with software)	
Practical Peripherals 2400 / 2400 V.42	75 / 115
2400 IBM PS/2	199
9600 V.42	269
External Hayes Compatibles	
Practical Peripherals 2400SA / 2400SA V.42	99 / 125
2400 Mac	135
9600SA V.42 bis	279.99
2400 Pocket Modem	99
2400V 42 Pocket Modem w/Send Fax	159
Other Hayes Compatibles	
Intel 9600 Baud with Software	440
Intel 9600 V.32bis with Software	499
All U.S. Robotics High Speed Models	CALL
Fax Boards	
Freecom Fax 96 Board	99
Freecom Fax / Modem	119
Intel SatisFAXtion Fax Board	CALL
Practical Peripherals Fax Modems	
2400 Baud Int. w/9600 Send/Recv. Fax	99
2400 Baud Ext. w/9600 Send/Recv. Fax	109
14400 V.32 Int. w/9600 Send/Recv. Fax	375
14400 V.32 Ext. w/9600 Send/Recv. Fax	399
Etronics Fax Modems	
2400 Baud Int. w/9600 Send/Recv. Fax	85
2400 Baud Ext. w/9600 Send/Recv. Fax	99

Prices subject to change; products subject to availability while quantities last. ELEK-TEK is not responsible for printing or typesetting errors.

RETURN POLICY-All sales are final except defective which will be replaced with identical merchandise only. Computers and large peripherals - 3 work days after delivery; most small items, 30 calendar days, after which manufacturer's warranty applies. No returns will be accepted without an RMA number. Unauthorized returns and refused shipments subject to 15% restocking charge. ALL ELEK-TEK MERCHANDISE IS BRAND NEW, FIRST QUALITY AND COMPLETE.
 In no event will ELEK-TEK be liable for any damages whether incidental, consequential or otherwise. Except as stated herein, no warranties (including fitness for a particular purpose or merchantability) shall apply. This does not reduce the benefit of any manufacturer's warranty. BY0421L

ET VALUELINE
 WHERE MORE THAN JUST THE PRICE IS RIGHT
 7350 North Linden Avenue, Skokie, Illinois 60077
800-395-1000 In IL: 708-677-7660
 ET Valueline is the telemarketing and mail order department of ELEK-TEK, Inc.

Become a legend before your own time.

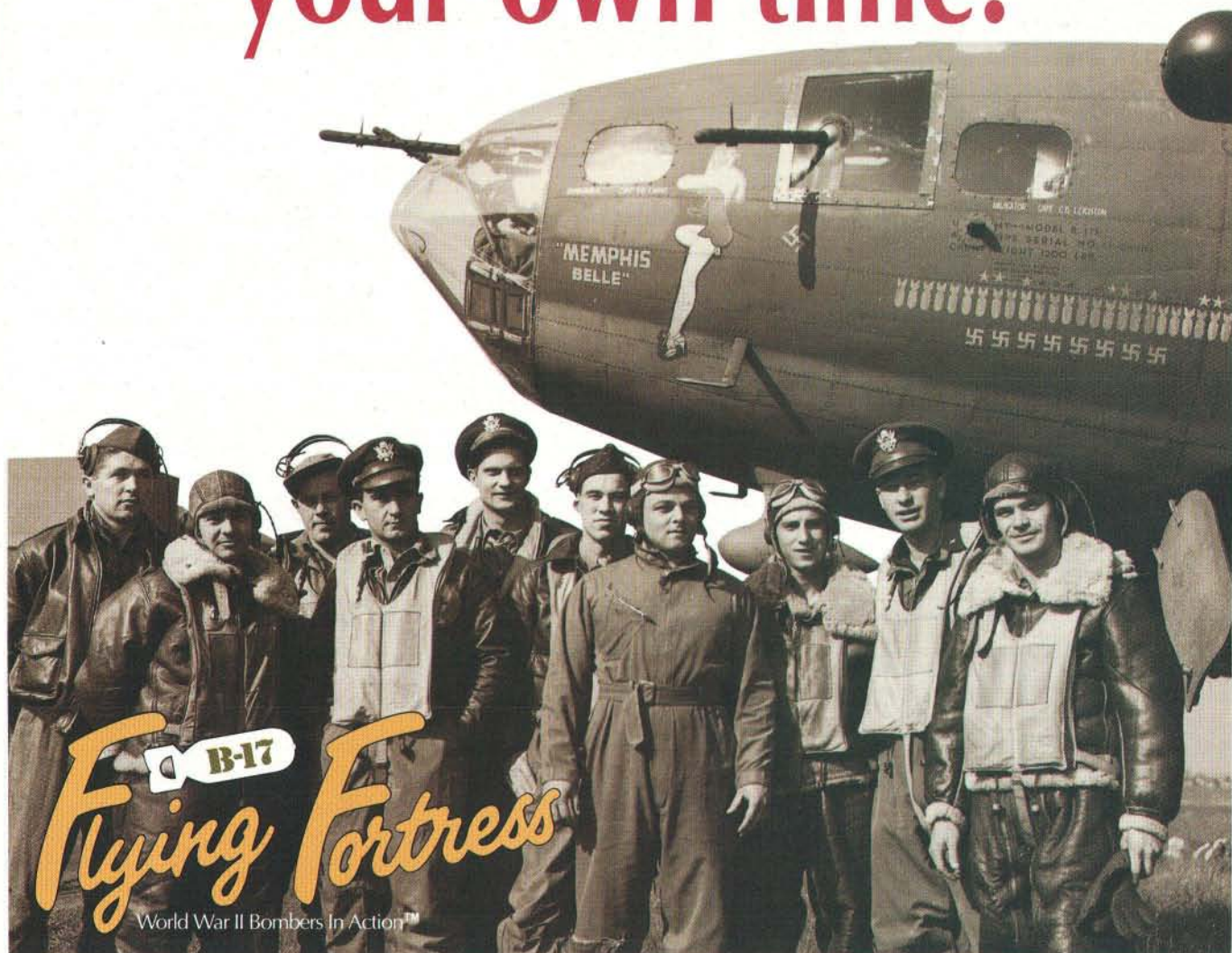

What becomes a legend most? Find out for yourself as you pilot the legendary **B-17 Flying Fortress** and lead a 10-man crew through the same flak-infested skies that menaced the legendary flyboys of the *Memphis Belle*.

The most complete and accurate bomber simulation ever produced, the **B-17 Flying Fortress** will have you negotiating 25 perilous daylight missions over Nazi-occupied Europe.

You'll allocate crew members to their specific tasks. You'll devastate strategic targets in dangerous bombing runs. You'll take control of crew positions from pilot to bombardier. And you'll even customize your own Flying Fortress with historically accurate nose art.

So pick up your copy of **B-17 Flying Fortress** today. And experience a flight simulation of legendary proportions.

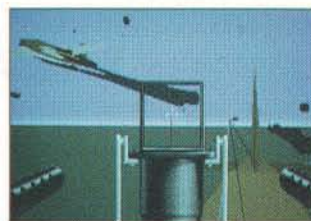

Actual screens may vary.

MICRO PROSETM
ENTERTAINMENT • SOFTWARE

For IBM PC compatibles!

For more information about exciting MicroProse products,
call **1-800-879-PLAY**

© 1992 MicroProse Software, Inc. ALL RIGHTS RESERVED.

Open Your Eyes and See the Value



\$995

Featuring the new Profex 386SX-25MHz. It's going to save your valuable desk space and of course your money too.

- 80386SX-25MHz CPU
- Optional 80387SX math co-processor
- 2MB memory on board
- 1.44MB 3.5" and 1.2MB 5.25" floppy drive
- 40MB 3.5" IDE hard drive
- 2 serial, 1 parallel, 1 game ports
- 512KB VGA controller on-board, expandable to 1MB, resolution 1024 x 768
- Super VGA monitor, 1024 x 768, dot pitch .28
- 101-key enhanced keyboard
- MS DOS 5.0
- One year on-site warranty

80386SX-16 \$965

BEST COMPONENTS

Only the finest, proven and tested components are used to build the Profex system.

TESTED, TESTED AND TESTED

We build our own computer systems, and we are more than glad to customize your specific needs. To maintain exceptionally high standards, all systems are burnt-in for 48 hours, every single details are carefully monitored.

COMMITTED TO SERVE YOU

Our commitment to you doesn't end with a sale. At all times, we are here to support you. Just call our toll free line, and professional technicians are here to help. All Profex system is backed by one year manufacturer warranty and free first year on-site warranty service.

YOUR SATISFACTION IS GUARANTEED

To further our commitment to customer satisfaction, Profex offers a 30-day money back guarantee. If you are not satisfied with the product for any reason within 30 days, just return it to us for a full refund on the system price.



LANWISE INC.

736 STIMSON AVENUE, INDUSTRY, CA 91745
TEL: 818-369-2288 FAX: 818-968-1388

All brand & product names are trademarks or registered trademarks of their respective owners. Price and spec subject to change without notice.



PROFEX 486-33 \$2290

- 80486-33MHz CPU
- Built-in 80387 math co-processor
- 64K cache memory
- 4MB memory on board, expandable to 32MB
- 1.44MB 3.5" and 1.2MB 5.25" floppy drive
- 210MB 3.5" IDE hard drive
- 2 serial, 1 parallel, 1 game ports
- Super VGA controller with 1MB RAM, resolution 1024 x 768
- Non-Interlaced Super VGA monitor, 1024 x 768, dot pitch .28
- Standard tower case with 250W power supply
- 101-key enhanced keyboard
- MS DOS, MS Windows with Mouse
- One year on-site warranty



PROFEX 386-33 \$1669

- 80386-33MHz CPU
- Optional 80387 math co-processor
- 64K cache memory
- 4MB memory on board, expandable to 32MB.
- 1.44MB 3.5" and 1.2MB 5.25" floppy drive
- 124MB 3.5" IDE hard drive
- 2 serial, 1 parallel, 1 game ports
- Super VGA controller with 1MB RAM, resolution 1024 x 768
- Non-Interlaced Super VGA monitor, 1024 x 768, dot pitch .28
- Mid tower or Desktop case with 220W power supply
- 101-key enhanced keyboard
- MS DOS, MS Windows with Mouse
- One year on-site warranty

80386-25 \$1580

80386-40 \$1699

ORDERING HOTLINE:

1-800-969-6688

Hours: Mon.-Fri. 8:30 a.m. - 6:30 p.m. Pacific Time



No Surcharge
on Credit
Cards

Circle 241 on Inquiry Card.

Printer Sharing That Maximizes Your High Speed PCs And Printers

HIGH SPEED PRINTER SHARING				
486 PC running at 33MHz into the Model 24SII DES 4 Page CAD file: 2.38MB	Model 24SII 2.38MB file Input Time min:sec	Print Time per Page* min:sec		
		HP III Si	HP III	HP II
PC Parallel Output	0:40	:14	:27	1:10
Parallel Output via Tran-x LPT-460 Parallel Extender at 460k baud	0:52	:14	:27	1:10
PC Serial Output at 115.2k baud	3:26	:52	:52	1:10

These results were obtained in lab tests using BayTech F-Print and with LS-1C installed in the HP III. Speeds will vary depending upon the application program being used.

*Time between pages in multiple page print jobs, first page print time may be slightly longer.

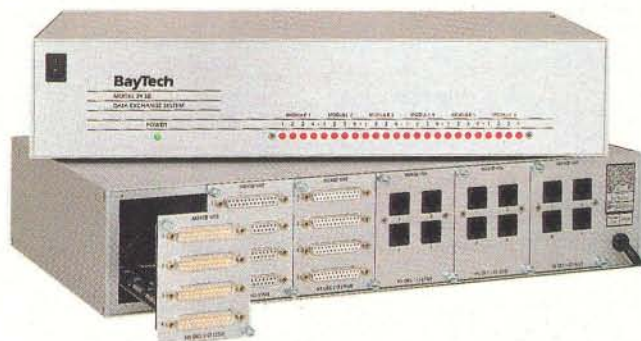

Outstanding Features:

- 5.5M bps total throughput speeds
- Up to 60,000 character per second parallel communications
- 46,000 character per second serial communications (printer sharing)
- Use with BayTech Tran-x parallel extension products for data transmission to 46,000 characters per second over 1000+ feet
- Expandable up to 24 ports
- Up to 8MB dynamically allocated buffer
- Full duplex communication at 115.2k baud for high speed file transfer
- Device selection while in Windows® or graphics programs

All product or company names are trademarks of their respective holders.

The Model 24SII DES Data Exchange System, with total throughput speed exceeding 5.5M bits per second, is the answer to your need for the fastest, cost effective peripheral sharing available.

These high speeds allow computers and file servers to off-load large text and graphic files to plotters, modems, printers, and other computers at extremely fast rates.

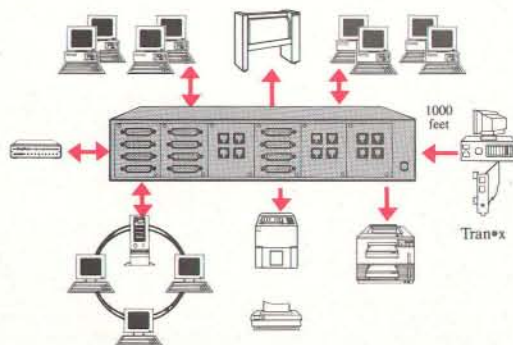

With more than 1.5 million connections, BayTech has been serving customers worldwide for over 16 years. For high speed data communications, contact a BayTech representative *today!*

Because Resources Should Be Shared

BayTech

Data Communications Products Division
200 N. Second Street, P.O. Box 387
Bay St. Louis, MS 39520

Fax: 601-467-4551 Phone: 601-467-8231 or toll-free

800-523-2702

High Speed Printer Sharing • Parallel Extension • Statistical Multiplexers • Data Acquisition Controllers



MEMO

WE WILL BEAT ANY ADVERTISED PRICE



SIMM-SIPP MODULES

4MB X 9-80NS SIMM-PC	149.00	256K X 9-80NS SIMM-PC	12.65	1MB X 9-80NS SIPP-PC	44.00
4MB X 9-70NS SIMM-PC	149.00	256K X 9-70NS SIMM-PC	13.00	1MB X 9-70NS SIPP-PC	44.00
4MB X 9-60NS SIMM-PC	165.00	256K X 9-60NS SIMM-PC	13.65	1MB X 9-60NS SIPP-PC	48.00
1MB X 9-100NS SIMM-PC	40.00	1MB X 9-100NS SIMM-MAC	40.00	256K X 9-100NS SIPP-PC	11.75
1MB X 9-80NS SIMM-PC	42.00	1MB X 9-80NS SIMM-MAC	42.00	256K X 9-80NS SIPP-PC	14.85
1MB X 9-70NS SIMM-PC	46.00	1MB X 9-70NS SIMM-MAC	45.00	256K X 9-70NS SIPP-PC	15.00
1MB X 9-60NS SIMM-PC	46.00	1MB X 9-60NS SIMM-MAC	45.00	256K X 9-60NS SIPP-PC	16.00
256K X 9-100NS SIMM-PC	9.75	1MB X 9-100NS SIPP-PC	42.50		

DYNAMIC RAMS

1MB X 1-100NS	4.40	256 X 1-80NS	1.80	64K X 4-120NS	1.75
1MB X 1-80NS	5.20	256K X 1-70NS	1.90	64K X 4-100NS	2.10
1MB X 1-70NS	5.25	256K X 1-60 NS	2.20	64K X 4-80NS	2.25
1MB X 1-60NS	5.30	256K X 4-100NS	4.75	64K X 1-150NS	1.50
256K X 1-150NS	1.50	256K X 4-80NS	2.20	64K X 1-120NS	1.75
256K X 1-120NS	1.55	256K X 4-70NS	5.35	64K X 1-100NS	1.95
256K X 1-100NS	1.70	256K X 4-60NS	5.40	256K X 1-STATIC RAM	
1 X 4-80NS	21.00	AAAZ800P-07 (256K)	2.85	AAAZ800P-07 (256K)	2.85
1 X 4-80NS	21.00	STATIC ZIPP		AAAZ800P-06 (256K)	3.05
1 X 4-80NS	21.00	ZIPP			

CACHE MEMORY

8 X 8-15	10.00
32 X 8-15	25.00
8 X 8-25	7.00
32 X 8-25	16.00
64 X 8-25	21.00
16 X 8-25	17.00
8 X 8-20	8.00
16 X 8-20	17.50
32 X 8-20	22.50
16 X 4-20	8.00

IBM MEMORY

LASER PRINTER	1MB BOARD	108136	\$ 83
MODEL 4014	2MB BOARD	108137	140
4016	3MB BOARD	108138	226
LASER PRINTER	1MB BOARD	118233	115
MODEL 4025	2MB BOARD	118234	185
4026	4MB BOARD	118235	290
PS/1 & 386SX	512K MODULE	152530	35
	2MB MODULE	329935	170
	4MB MODULE	329936	200
PS/2 286	128K KIT	706865	28
PS/2 2586	512K KIT	293548	85
30-286	512K KIT	293550	115

APPLE MEMORY

POWERBOOK 100	2MB MCL	MI0231A	\$100
	4MB MCL	MI0231B	200
	8MB MCL	MI0231C	300
POWERBOOK 140/170	2MB MCL	MI0231A	100
	4MB MCL	MI0231B	200
	8MB MCL	MI0231C	300
QUADRA 700	4MB KIT	MI0231A	100
	8MB KIT	MI0231B	200
	16MB KIT	MI0231C	300
QUADRA 600	4MB KIT	MI0231A	100
	8MB KIT	MI0231B	200
	16MB KIT	MI0231C	300

EVEREX MEMORY

TEMPO LX	2MB MODULE	PCA-00063-00	\$ 100
TEMPO LX20	2MB MODULE	PCA-00064-00	200
TEMPO 286	128K KIT	NA	40
	256K KIT	NA	125
TEMPO 386SX	1MB KIT	NA	60
	2MB KIT	NA	100
	4MB KIT	NA	225
	8MB KIT	NA	350
286 STEP 12, 18	1MB KIT	NA	60
	2MB KIT	NA	100
	4MB KIT	NA	225
286 STEP 230	1MB KIT	NA	60
	2MB KIT	NA	100
	4MB KIT	NA	225
386 STEP	1MB KIT	NA	60
16, 20, 25	2MB KIT	NA	100
	4MB KIT	NA	225
STEP 386SX	4MB KIT	NA	225
	8MB KIT	NA	350

NEC MEMORY

POWERMATE SX	1-4MB BOARD	APC-885E	\$218
	1-4MB BOARD	APC-885E	258
	4-4MB BOARD	APC-885E	415
	8-4MB BOARD	APC-885E	772
POWERMATE 386/16	4-4MB BOARD	NA	750
	8-4MB BOARD	NA	988
	16-4MB BOARD	NA	1322
POWERMATE BUSINESS 386/25	4-4MB BOARD	NA	537
	8-4MB BOARD	NA	772
	16-4MB BOARD	NA	1250
POWERMATE BUSINESS 386/25	2MB KIT (PC-410-010)	\$160	
	4MB KIT (PC-410-010)	212	
POWERMATE SVX20	2MB MODULE	PC-410-010	212
	4MB MODULE	PC-410-010	212
POWERMATE SVX16	2MB MODULE	PC-410-010	212
	4MB MODULE	PC-410-010	212
POWERMATE SX	4-4MB BOARD	APC-885E	744
	8-4MB BOARD	APC-885E	1322

LASER PRINTER

SUPERSPOT	1MB MODULE	Z410-81	\$120
BROTHER-H4	2MB MODULE	Z410-84	185
386 ONLY	2MB MODULE	Z410-85	185
386 ONLY	4MB MODULE	Z410-87	CALL
BLISSPLOT	1MB MODULE	Z410-85	185
	2MB MODULE	Z410-86	185
	4MB MODULE	Z410-87	390
MASTERPOST	1MB MODULE	Z410-81	145
MASTERPOST SLK 386C	2MB MODULE	Z4-4-1	215
	4MB MODULE	Z4-4-1	215

TOSHIBA MEMORY

PORTABLE 11000	1MB CARD	PC-F43110	\$ 100
11000SX	2MB CARD	PC-F43110	100
PORTABLE T2000SX	1MB CARD	PC-F43110	100
T2000SX	2MB CARD	PC-F43110	100
PORTABLE T1000SX	1MB CARD	PC-F43110	100
T1000SX	2MB CARD	PC-F43110	100
PORTABLE T1000SX	1MB CARD	PC-F43110	100
T1000SX	2MB CARD	PC-F43110	100

HP VECTRA MEMORY

88PC, 88372SET	1MB SIMM	DT135A	\$70
88PC, 88372SET	2MB SIMM	DT135A	120
88PC, 88372SET	4MB SIMM	DT135A	200
88PC, 88372SET	8MB SIMM	DT135A	350
88PC, 88372SET	16MB SIMM	DT135A	600
88PC, 88372SET	32MB SIMM	DT135A	1000
88PC, 88372SET	64MB SIMM	DT135A	1800
88PC, 88372SET	128MB SIMM	DT135A	3200
88PC, 88372SET	256MB SIMM	DT135A	5800

ALR MEMORY

VENTURA	1MB MODULE	1247010	\$225
NOTEBOOK 180	4MB MODULE	1407180	1200
POWERLEX 4300SX	1MB KIT	1290010	70
	2MB KIT	1290020	140
	4MB KIT	1290030	210
	8MB KIT	1290040	380
	16MB KIT	1290050	700
POWERPRO	4MB KIT	1290060	210
	8MB KIT	1290070	380
	16MB KIT	1290080	700
	32MB KIT	1290090	1400

LAPTOP MEMORY

BONDWELL	2MB MODULE	2359-0100	\$150
BONDWELL	4MB MODULE	2359-0100	150
BONDWELL	8MB MODULE	2359-0100	150
BONDWELL	16MB MODULE	2359-0100	150
BONDWELL	32MB MODULE	2359-0100	150
BONDWELL	64MB MODULE	2359-0100	150
BONDWELL	128MB MODULE	2359-0100	150
BONDWELL	256MB MODULE	2359-0100	150

NCR MEMORY

PC286 EPC386SX	2MB KIT	3354-1012	\$162
PC286 EPC386SX	4MB KIT	3354-1012	162
PC286 EPC386SX	8MB KIT	3354-1012	162
PC286 EPC386SX	16MB KIT	3354-1012	162
PC286 EPC386SX	32MB KIT	3354-1012	162
PC286 EPC386SX	64MB KIT	3354-1012	162
PC286 EPC386SX	128MB KIT	3354-1012	162
PC286 EPC386SX	256MB KIT	3354-1012	162

ZENITH MEMORY

Z48038ET	4MB MODULE	Z48038-00	\$225
Z48038ET	8MB MODULE	Z48038-00	225
Z48038ET	16MB MODULE	Z48038-00	225
Z48038ET	32MB MODULE	Z48038-00	225
Z48038ET	64MB MODULE	Z48038-00	225
Z48038ET	128MB MODULE	Z48038-00	225
Z48038ET	256MB MODULE	Z48038-00	225

COMPAG MEMORY

DESKPRO 286	512K KIT	11307-001	\$ 45
DESKPRO 386	1024K KIT	11311-001	85
DESKPRO 386	2048K KIT	11312-001	125
DESKPRO 386	EXP BOARD	11310-001	80
DESKPRO 386	1MB SIMM	11868-001	70
DESKPRO 386	2MB SIMM	11869-001	110
DESKPRO 386	4MB SIMM	11870-001	150
DESKPRO 386	8MB SIMM	11871-001	210
DESKPRO 386	16MB SIMM	11872-001	280
DESKPRO 386	32MB SIMM	11873-001	410
DESKPRO 386	64MB SIMM	11874-001	610
DESKPRO 386	128MB SIMM	11875-001	880
DESKPRO 386	256MB SIMM	11876-001	1280
DESKPRO 386	512MB SIMM	11877-001	1920
DESKPRO 386	1024MB SIMM	11878-001	2880
DESKPRO 386	2048MB SIMM	11879-001	4320
DESKPRO 386	4096MB SIMM	11880-001	6480
DESKPRO 386	8192MB SIMM	11881-001	9720
DESKPRO 386	16384MB SIMM	11882-001	14580
DESKPRO 386	32768MB SIMM	11883-001	21870
DESKPRO 386	65536MB SIMM	11884-001	32805
DESKPRO 386	131072MB SIMM	11885-001	49215
DESKPRO 386	262144MB SIMM	11886-001	73620
DESKPRO 386	524288MB SIMM	11887-001	109470
DESKPRO 386	1048576MB SIMM	11888-001	164205
DESKPRO 386	2097152MB SIMM	11889-001	246300
DESKPRO 386	4194304MB SIMM	11890-001	369405
DESKPRO 386	8388608MB SIMM	11891-001	544200
DESKPRO 386	16777216MB SIMM	11892-001	801300
DESKPRO 386	33554432MB SIMM	11893-001	1181850
DESKPRO 386	67108864MB SIMM	11894-001	1722705
DESKPRO 386	134217728MB SIMM	11895-001	2523960
DESKPRO 386	268435456MB SIMM	11896-001	3635715
DESKPRO 386	536870912MB SIMM	11897-001	5251020
DESKPRO 386	1073741824MB SIMM	11898-001	7576325
DESKPRO 386	2147483648MB SIMM	11899-001	10911630
DESKPRO 386	4294967296MB SIMM	11900-001	15766335
DESKPRO 386	8589934592MB SIMM	11901-001	22819040
DESKPRO 386	17179869184MB SIMM	11902-001	33227145
DESKPRO 386	34359738368MB SIMM	11903-001	48189250
DESKPRO 386	68719476736MB SIMM	11904-001	69466355
DESKPRO 386	137438953472MB SIMM	11905-001	100000000
DESKPRO 386	274877906944MB SIMM	11906-001	144000000
DESKPRO 386	549755813888MB SIMM	11907-001	207000000
DESKPRO 386	1099511627776MB SIMM	11908-001	297000000
DESKPRO 386	2199023255552MB SIMM	11909-001	420000000
DESKPRO 386	4398046511104MB SIMM	11910-001	597000000
DESKPRO 386	8796093022208MB SIMM	11911-001	840000000
DESKPRO 386	17592186444416MB SIMM	11912-001	1170000000
DESKPRO 386	35184372888832MB SIMM	11913-001	1620000000
DESKPRO 386	70368745777664MB SIMM	11914-001	2250000000
DESKPRO 386	14073749155328MB SIMM	11915-001	3150000000
DESKPRO 386	28147498310656MB SIMM	11916-001	4350000000
DESKPRO 386	56294996621312MB SIMM	11917-001	5925000000
DESKPRO 386	112589993242624MB SIMM	11918-001	8025000000
DESKPRO 386	225179986485248MB SIMM	11919-001	10950000000
DESKPRO 386	450359972970496MB SIMM	11920-001	14850000000
DESKPRO 386	900719945940992MB SIMM	11921-001	20250000000
DESKPRO 386	1801439891881984MB SIMM	11922-001	27750000000
DESKPRO 386	3602879783763968MB SIMM	11923-001	37500000000
DESKPRO 386	7205759567527936MB SIMM	11924-001	50750000000
DESKPRO 386	14411519130554772MB SIMM	11925-001	69000000000
DESKPRO 386	28823038261109544MB SIMM	11926-001	92250000000
DESKPRO 386	57646076522219088MB SIMM	11927-001	123000000000
DESKPRO 386	11529215304438176MB SIMM	11928-001	165000000000
DESKPRO 386	23058430608876352MB SIMM	11929-001	220000000000
DESKPRO 386	46116861217752704MB SIMM	11930-001	295000000000
DESKPRO 386	92233722435505408MB SIMM	11931-001	395000000000
DESKPRO 386	18446744887100896MB SIMM	11932-001	530000000000
DESKPRO 386			

Remote connectivity

up to
57.6K bps*

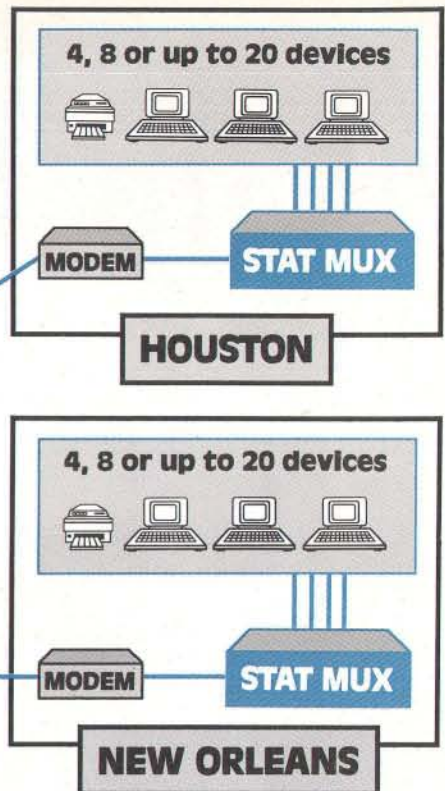
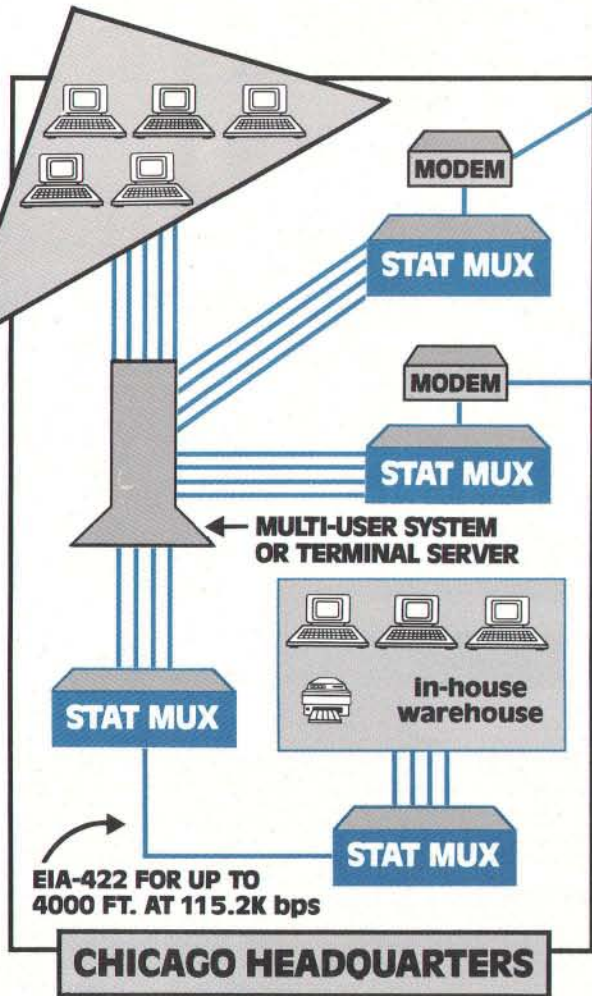

The Telpex® line of asynchronous statistical multiplexers by BayTech are designed to provide user flexibility and to maximize speed by effective utilization of high speed modem technology. Telpex stat muxes support hardwire connectivity for distances to 4000 feet.

- Approaches ISDN throughput speeds
- Affordable prices
- 4, 8 or up to 20 channels
- Composite port speeds selectable from 50 bps to 115.2K bps
- Remote configuration and diagnostics
- Internal dial up or lease line modems available
- Unlimited toll-free technical support

BayTech gives you 15 years of data communications experience. Call now for affordable, high performance multiplexers, modems, peripheral sharing, and data acquisition/control devices.

Because Resources Should Be Shared

BayTech



Data Communications Products Division
200 N. 2nd St., P.O. Box 387, Bay Saint Louis, MS 39520
Fax: 601-467-4551 Phone: 601-467-8231 or toll-free

800-523-2702

All product or company names are trademarks of their respective holders.
*Over dial up line using a V.32bis/V.42bis modem.

INTERNATIONAL DISTRIBUTORS

Australia
Shuttle Computer Systems
(03) 596 8888

Belgium
Multiway Data Belgium
03-666-3854

Denmark
Trend Communications
A/S
53 65 23 45

Finland
Genine Oy Impdata
(921) 547200

France
Gradeo France
(1) 42 94 99 69

Germany
Munich
AMS Computech GmbH
(089) 126806-0

Düsseldorf
Multiway Data Germany
211-251875

Italy
Torino
BRM Italiani
(011) 771.00.10

Milano
I.T.D.
(02) 749.0749

Mexico
Intertec
(52-83) 33-6622

Netherlands
Multiway Data
Netherlands
079-424 111

Norway
A/S Kjell-Bakke
47-6-832000

Singapore
Mark Systems (FE)
Pte., Limited
65-2261877

Spain
Vidmar Control
(93)2454803

Sweden
Maldata Teknik AB
46-8-705 36 00

Switzerland
Sengstag Computers AG
0041.1.950.54.44

United Kingdom
A-Line Dataspeed
Devices Ltd.
(0533) 778899

Trend Communications
Limited
(0628) 530611

16MB TECHNOLOGY NOW!!!

ACER 486sx - 16MB SIMM (4 X 36)	\$ 599.00
32MB SIMM (8 X 36)	\$ 1999.00
COMPAQ SystemPro - 32MB MODULE	\$ 1599.00
DELL 486's - 16MB KIT (2 SIMMS)	\$ 699.00
32MB KIT (2 SIMMS)	\$ 1199.00
MAC IIfx - 64MB KIT (4 SIMMS)	\$ 2396.00
MAC IIfci,IIfcx,QUADRA 900 - 64MB KIT (4 SIMMS)	\$ 2396.00
MAC QUADRA 700 - 64MB KIT (4 SIMMS)	\$ 2436.00
SUN IPX,ELC - 16MB SIMM	\$ 499.00

OTHER MEMORIES AVAILABLE...

IBM

PS/1 - 2MB	\$ 109
4MB	\$ 179
M30 - 2MB	\$ 105
M50Z,55sx,65sx,70 - 1MB	\$ 52
2MB	\$ 109
4MB	\$ 179
M70-A21,A61,121 - 2MB	\$ 109
M40sx,35sx - 8MB	\$ 389
M57sx,90,95 - 4MB	\$ 189
8MB	\$ 389
M80-041 - 1MB	\$ 85
M80-111,121,311 - 2MB	\$ 135
M80-A21,A31 - 4MB	\$ 238
16-BIT OK Exp Board	\$ 169
32-BIT OK Exp Board	\$ 189

AST

PREM. 386/20C - 1MB KIT	\$ 69
PREM. 386/25 - 1MB	\$ 59
PREM. 486/25 - 1MB	\$ 59
PREM. II 486 - 1MB	\$ 59
4MB	\$ 189
8MB KIT	\$ 389
PREM. II 1MB Exp Board	\$ 479

COMPAQ

DP 386/20,20E,25 - 1MB	\$ 79
4MB	\$ 189
DP 386S/16 - 1MB	\$ 79
4MB	\$ 189
DP 286N,386N,S/20 - 4MB	\$ 179
M-SYSTEMS - 2MB	\$ 105
4MB	\$ 179
8MB	\$ 389
DP 386/33,486/25 - 2MB	\$ 119
SystemPro - 8MB	\$ 399
OK Exp Brd	\$ 349
DP 386S/16 1MB Exp Brd	\$ 139
DP 386/20,20E,25,25E	
1MB Exp. Board	\$ 139

DELL

325D,P;333D,P - 1MB	\$ 52
4MB	\$ 179
420,425,433 - 2MB KIT	\$ 104
4MB KIT	\$ 209
8MB KIT	\$ 359
450DE,450SE - 2MB KIT	\$ 104
4MB KIT	\$ 209
8MB KIT	\$ 359

HP

Vectra QS-16 - 2MB KIT	\$ 129
4MB KIT	\$ 229
Vectra 486 - 2MB	\$ 105
4MB	\$ 179
8MB	\$ 389
X-Station 700 Ser. - 2MB	\$ 105
4MB	\$ 179
8MB	\$ 389
9000/400t,425t - 8MB KIT	\$ 699
16MB KIT	\$ 1599
32MB KIT	\$ 2899
9000/425e - 8MB KIT	\$ 469
16MB KIT	\$ 899

APPLE

II,SE,SE/30 - 1MB	\$ 37
Classic - 1MB Exp. Board	\$ 59
SE/30,IIfci,IIfcx,IIfsi,LC &	
Quad. 700,900 - 4MB	\$ 129
Quad. 700,900 - 32MB KIT	\$ 1499
IIfx - 16MB KIT	\$ 499
IIfx - 32MB KIT	\$ 1499
Quadra 256K V-RAM	\$ 45
LC 512K V-RAM	\$ 69

LAPTOPS

AST EXEC. NB - 4MB	\$ 169
COMPAQ LTE386 - 4MB	\$ 278
SLT386 - 4MB	\$ 249
DELL 316,320 LT - 2MB	\$ 119
EVEREX TEMPO - 2MB	\$ 95
IBM L40sx - 4MB	\$ 209
MAC POWERBOOK - 2MB	\$ 179
NEC P.S. 286,386sx - 4MB	\$ 269
P.S. 386 - 8MB	\$ 519
P.S. SX/20 - 4MB	\$ 259
PANASONIC CF170 - 1MB	\$ 65
T.I. TRVL-MT 3000 - 2MB	\$ 99
TOSHIBA 1000 - 2MB	\$ 159
2000SX - 8MB	\$ 539
3200SXC - 4MB	\$ 188
5200 - 8MB	\$ 379

PRINTERS

EPSON 6000 - 4MB	\$ 248
HP IIP,IIID,P - 2MB	\$ 119
IIfsi - 4MB	\$ 189
IBM 4019,4029e - 3.5MB	\$ 198
4029 - 4MB	\$ 269
OKIDATA 400 - 2MB	\$ 149

PRICES SUBJECT TO CHANGE WITHOUT NOTICE

OTHER MEMORIES FOR:

ACER, ALTIMA, APPLE, AST, CHAPLET, COMPAQ, DELL, EPSON, EVEREX, HP, LEADING EDGE, IBM, NEC, NCR, OKIDATA, PACKARD-BELL, PANASONIC, PHILIP, SAMPO, SHARP, SILICON GRAPHICS, SUN MICROSYSTEMS, TANDON, TI, TOSHIBA, TULIP AND ZENITH.

CALL FOR OUR COMPLETE CATALOG

TERMS: C.O.D. CASH, VISA OR MASTERCARD.
COMPANY AND UNIVERSITY P.O.'S ACCEPTED UPON CREDIT APPROVAL.

414 CLOVERLEAF DR., UNIT B, BALDWIN PARK, CA 91706
TEL. (818)855-5688 FAX (818)855-5687



Windows Up to 50x Faster.



33MHz 486 32-Bit Local Bus

- 64K Super Fast Write-Back Cache RAM
- 4MB RAM (70ns) & Built-in 487 Math Coprocessor
- 1.2MB 5.25" & 1.44MB 3.5" Floppy Drives
- 130MB 15ms IDE Drive with 64K Cache
- 32-Bit Local Bus **TURBO SVGA** Card with 1MB RAM (Up to 1280x1024 & up to 32,768 Colors) (5 times faster than standard super VGA)
- 14" Non-Interlaced .28mm SVGA Color Monitor (VESA Standard for 72Hz Flicker-free Display)
 - 2 Serial, 1 Parallel, & 1 Game Ports
 - Quality 101-key Keyboard
 - Hi-Resolution 400DPI Serial Mouse
 - Microsoft DOS 5.0 & Windows 3.1

\$1995

- Above System with 8MB RAM & 210MB Drive \$2395
- 486DX2-50MHz Local Bus System add \$280
- 32-Bit Local Bus IDE Hard Disk Controller add \$100

33MHz 486 32-Bit Win-Station

- 64K Super Fast Write-Back Cache RAM
- 4MB RAM (70ns) & Built-in 487 Math Coprocessor
- 1.2MB 5.25" & 1.44MB 3.5" Floppy Drives
- 130MB 15ms IDE Drive with 64K Cache
- 32-Bit **TARGA S3** Local Bus & Graphics Accelerator with 1MB VRAM (Up to 1280x1024 & up to 32,768 Colors) (Up to 50 times faster than standard super VGA)
- 14" Non-Interlaced .28mm SVGA Color Monitor (VESA Standard for 72Hz Flicker-free Display)
 - 2 Serial, 1 Parallel, & 1 Game Ports
 - Quality 101-key Keyboard
 - Hi-Resolution 400DPI Serial Mouse
 - Microsoft DOS 5.0 & Windows 3.1

\$2155

- Above System with 8MB RAM & 210MB Drive \$2555
- 486DX2-50MHz Win-Station System add \$280
- 32-Bit Local Bus IDE Hard Disk Controller add \$100

Super Cache Systems

- 64K Super Fast Write-Back Cache RAM
 - 4MB RAM (70ns)
- 1.2MB 5.25" & 1.44MB 3.5" Floppy Drives
- 130MB 15ms IDE Drive with 64K Cache
 - 16-Bit Super VGA with 1MB RAM
- 14" Non-Interlaced .28mm SVGA Color Monitor (VESA Standard for 72Hz Flicker-free Display)
 - 2 Serial, 1 Parallel, & 1 Game Ports
 - Quality 101-key Keyboard
 - Hi-Resolution 400DPI Serial Mouse
 - Microsoft DOS 5.0 & Windows 3.1

486/50MHz \$2245 386/40MHz \$1575

486/33MHz \$1895 386/33MHz \$1575

486/20MHz \$1775 Above System with 8MB RAM & 210MB Drive Add \$420

1.800.969.2123

International 818.961.6688
 FAX 818.369.1479
 Hours: 7:00-7:30 Pacific Mon-Fri
 9:00-6:00 Pacific Sat
 15314 East Valley Boulevard
 City of Industry, California 91746



"Where Quality is Everything"

THAT'S RIGHT! • PC MAGAZINE
 WINDOWS BENCHMARK TESTS INDICATED

SPEED INCREASES AS HIGH AS 50 TIMES FASTER THAN THE STANDARD SVGA. WHILE MANY COMPUTERS HAVE ADDED 32-BIT GRAPHICS ACCELERATORS, THEIR REAL-TIME SPEEDS ARE STILL LIMITED BY A 16-BIT AT BUS.

BUT COMTRADE'S 33/486 WIN-STATIONS USE A REAL 32-BIT LOCAL-BUS VIDEO SLOT TO BYPASS THE AT BUS BOTTLENECK. THIS ENABLES THE 32-BIT BUS TO CONNECT DIRECTLY TO THE 32-BIT 486 CPU AND RUN AT THE TRUE CPU CLOCK SPEED OF 33MHZ. ALTHOUGH OTHER COMPUTERS CLAIM TO HAVE A 32-BIT LOCAL BUS, MOST ARE ACTUALLY MADE OF TWO 16-BIT ISA BUSES WHICH LIMIT SPEED TO 8 MHZ REGARDLESS OF CPU SPEED. BUT BECAUSE COMTRADE'S REAL 32-BIT BUS CONNECTS DIRECTLY, IT DOES NOT LIMIT SPEED, AND THROUGHPUT IS MAXIMIZED AT THE ACTUAL CPU SPEED OF 33 MHZ.

NEEDLESS TO SAY, THIS TRANSLATES INTO A SYSTEM SO FAST AND SO POWERFUL THAT WE INVITE COMPARISON! (SEE CHART #1 AND CHART #2) • SO STOP WINDOW SHOPPING. IT'S TIME TO BUY A COMTRADE 486 32-BIT WORKSTATION.

NEEDLESS TO SAY, THIS TRANSLATES INTO A SYSTEM SO FAST AND SO POWERFUL THAT WE INVITE COMPARISON! (SEE CHART #1 AND CHART #2) • SO STOP WINDOW SHOPPING. IT'S TIME TO BUY A COMTRADE 486 32-BIT WORKSTATION.

NEEDLESS TO SAY, THIS TRANSLATES INTO A SYSTEM SO FAST AND SO POWERFUL THAT WE INVITE COMPARISON! (SEE CHART #1 AND CHART #2) • SO STOP WINDOW SHOPPING. IT'S TIME TO BUY A COMTRADE 486 32-BIT WORKSTATION.

NEEDLESS TO SAY, THIS TRANSLATES INTO A SYSTEM SO FAST AND SO POWERFUL THAT WE INVITE COMPARISON! (SEE CHART #1 AND CHART #2) • SO STOP WINDOW SHOPPING. IT'S TIME TO BUY A COMTRADE 486 32-BIT WORKSTATION.

Circle 227 on Inquiry Card (RESELLERS: 228).

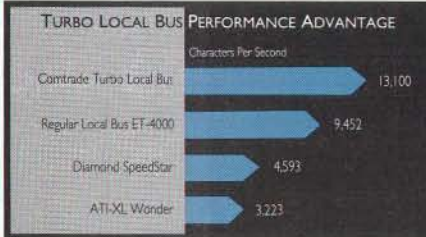

Source: Landmark Speed v.2.0 Video benchmark test

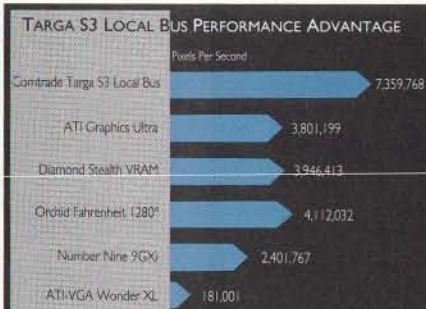

Source: PC Magazine's WINBENCH test (March 17, 1992)

Get your copy of Computer Hotline!

ACP-The Superstore that sells Direct

ALL USA ORDER 1-800-FONE-ACP

Hard Drives

Western Digital

High performance "Caviar" series with 1" height, Cache Flow™ and 32K buffer.
 AC280 80Mb 1" 3.5" 14ms IDE299
 AC2120 125Mb 1" 3.5" 14ms IDE375
 AC2200 200Mb 1" 3.5" 14ms IDE589

Maxtor

7080A 80Mb 1" 3.5" 15ms IDE279
 7120A 120Mb 1" 3.5" 15ms IDE388
 LX1213A 213Mb 1" 3.5" 15ms IDE699
 MX1240 1.2Gb 1" 3.5" 15ms IDE1995
 Panther 1.2Gb\$1995 Panther 1.7Gb 2595

Conner Peripherals

30104 120Mb 3.5" 19ms IDE389
 3204 200Mb 3.5" 16ms IDE589
Call for Quantum, Micropolis, Seagate. Also controllers from Ultrastor, Always, WD etc.

Hard Drive Cards

Plus Development

Hard Card IXL 50Mb 16bit 9ms298
 Hard Card IXL 105Mb 16bit 9ms448

Backups

Colorado

DJ10 120Mb Tape Drive internal ...235
 DJ20 250Mb Tape Drive internal ...319
 QFA700 700Mb Tape Drive internal ...779

Syquest

44Mb Removable 5.25" Drive int.308
 88Mb Removable 5.25" Drive Int.469
 Dual drive case with power supply169

SyDOS

SyDOS 44Mb external (8-bit)649
 Syquest 88Mb external (8-bit)749
 Includes caching software, manual, SCSI card and SyDOS BIOS.

Floppy Disk Drives

Toshiba

ND04DG 360K 5.25" HH PC/XT59
 ND08DE 1.2Mb 5.25" HH PC/AT72
 ND3561GR1.44Mb 3.5" HH w/AT Kit ..72

ACP

360K 5.25"HH55 1.2Mb 5.25"HH...66
 720K 3.5" HH59 1.44Mb 3.5" HH...67
 2.88Mb3.5"HH .Call **Call for 5.25" Mtg. Kit**

Pacific Rim

1.2Mb External for any parallel port ..235
 1.44Mb External for any parallel port ..235

Multimedia

Sony

7205 CD Laser Library w/six CD's549

Brown-Wagh • Creative Labs

Complete all-in-one MPC compatible upgrade kit includes: Panasonic CD Drive, Sound Blaster Pro, five CD's, Microsoft Multimedia Windows, Bookshelf, Hyperglide, Games, drivers, cables, connectors and more. Multimedia Kit internal579
 Sound Blaster /Pro129/229

MediaVision

PC Multimedia Kit int/ext799/1049
 Pro Spectrum Plus/16239/299

NEC Technologies

CDR-36 Portable CD ROM395
 CDR-36 w/CD Gallery/PC575

Input Devices

ACP 3-button Mouse (limited supply) 14 95
 CH Products Flightstick49
 Mouseman Combo/ Cordless75/88
 Logitech Trackman serial/bus69/72
 Logitech Trackman Portable104
 Logitech Fotoman599
 Microspeed PC-Trac ser/bus79/89

Michaelangelo, Friday the 13th PLUS over 1000 other Viruses!!!

7777

SYMANTEC Norton AntiVirus v2.0



The perfect antidote for virus infected systems plus on-going preventative care. Includes Norton's 24-hour Virus FAX-Line for updates when new viruses appear.

Chips and SIMM's

RAM Chips

41256-100 256K RAM 100ns DIP ...1.99
 41256-80 256K RAM 80ns DIP ...2.19
 414256-80 256Kx4 RAM 80ns DIP ...7.95
 1Mb-100 1Mb RAM 100ns DIP ...5.49
 1Mb-80 1Mb RAM 80ns DIP ...5.99

Over 200,000 IC's in-stock including 7400, LS, ALS, CMOS, linear all types! Plus Sockets, Crystals, Connectors and more

SIMM Modules

421000A9B-10 1Mbx9 100ns SIMM .38.95
 421000A9B-80 1Mbx9 80ns SIMM .39.95
 421000A9B-70 1Mbx9 70ns SIMM .54.95
 424000A9B-80 4Mbx9 80ns SIMM149
 424000A9B-70 4Mbx9 70ns SIMM159
 41256A9B-80 256Kx9 80ns SIMM .19.95
 A21000A3B-80 1Mbx9 (3 CHIP)36.95

Math Coprocessors

AMD

Increase the performance of your 286 powered PC/AT
 80C287-10 Coprocessor 10MHz49.95

Intel

8087 5MHz79 80387DXP 16/33 ...199
 8087-2 8MHz89 80387SX-16128
 8087-1 10MHz89 80387SX-20144
 80287XL all 286 ...89 80487SX-20499

Cyrix

83D87-1616MHz169 83D87-40 40MHz239
 83D87-2020MHz175 83S87-SX16114
 83D87-2525MHz175 83S87-SX20129
 83D87-3333MHz189 83S87-SX25149

IIT

2C87-8 8MHz79 2C87-12 12MHz ..85
 2C87-10 10MHz .85 2C87-20 20MHz ..99

Memory Upgrades

Laser Printer Upgrades

HP IIP+/IIP+/IIP/IIIP 2Mb124
 Okidata OL400 2Mb148
 Okidata OL800/820 2Mb148
 Panasonic 4420/4450 2Mb148

Call for other models plus we stock most Laser memory upgrades with OK RAM

Laptop Upgrades

Apple Powerbook 2Mb127
 AST Executive 1Mb78
 Compaq LTE386s/20 2Mb178
 Everex Tempo/LX/16 2Mb147
 IBM L40SX 2Mb127
 Toshiba T1000SE/LE/XE/2000 2Mb228
 Toshiba T2000SXe 2Mb228
 Toshiba T3300SL/4400SX 2MbCall
Call for NEC, HP, Zenith, Leading Edge.

Palmtop Upgrades

HP 95LX 2Mb ...Call Poquet 1Mb ...327

Computer Upgrades

AST Premium 386/25.33, SX16/20 1Mb 68
 Compaq DP386/33.486/33.SysPro 2Mb 128
 IBM 30-286 #30F5360 2Mb 108
 IBM 35.40.55sx.65.70 #6450604 2Mb 118
 IBM 90.95.P75 #6450902 2Mb 118
Call for NEC, HP, Zenith, Leading Edge.

Micronics Gemini DX2 486DX/50

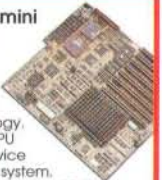

Supports Intel 486™ DX2 clock doubler technology. Allows internal CPU function to run twice the speed of the system. Has baby AT form factor, 256k direct mapped cache and RAM expandable to 64Mb.
 486DX2/50MHz ISA baby) \$1399
 486DX/33MHz (ISA) \$ 999
 486DX/33MHz (EISA) \$1199
 486DX/33MHz (ISA baby) \$ 849

Motherboards

ACP 286-12 half-size board w/OK89
 ACP 386SX-20/25 w/OK226/269
 ACP 386DX-33 64K cache w/OK399
 ACP 386DX-40 64K cache w/OK419
 ACP 486DX-33 256K cache w/OK799
 Orchid 386/40 128K cache w/OK599
 Orchid 486/50DX 256K cache1799

Processor Upgrades

Kingston

SX/Now 20MHz SX upgrade module ...349
 SX/Now 25MHz SX upgrade module ...419
Specify for IBM PS/2 or AT, AST, HP ES286/12

Leading Edge Computers

These Leading Edge Systems include...

- Enhanced 101 Keyboard • High Performance Hard Drives
- 20 Months Warranty • Mouse • Free MS-DOS
- MS Works for Windows • MS Windows • Virus Scan

COMPUTER	SX PLUS 20	Minitower 33	486SX/20*	486DX/33*
Model #	D3SP2131	D3MT2131	D4S2131	D4D2131
MRP\$	1499.00	2299.00	2299.00	2499.00
CPU	386SX/20	386DX/33	486SX/20	486DX/33
Hard Drive	130 Mb	130 Mb	130 Mb	130 Mb
RAM	2 MB	4 MB	4 MB	4 MB
Max. RAM	16 Mb	64 Mb	64 Mb	64 Mb
Cache RAM	-----	16K	64K	64K
Exp. Slots	4	6	8	8
Video/SVGA	800x600/256K	1024x768/512K	1024x768/512K	1024x768/512K
I/O	2 ser.par,mse	2 ser.par,mse	2 ser.par,mse	2 ser.par,mse
ACP Price	1049.	1599.	1699.	1999.

*486SX supports CPU card upgrades



New! 386SL-25 MHz Notebooks

- Low Power Design plus SCSI-2
 - 2Mb RAM expand up to 10Mb
 - VGA-64 shades • Mouse "J"
 - 32k Cache • **60Mb...\$1999.**
- NEW! Color 386SL Notebooks**
60Mb...\$2799. 80Mb...\$2999.

Leading Edge Monitors

CMON.42 640 X 480 .42 dot
 CMON.39AD 1024 X 768 .39 dot
 CMON.28AD 1024 X 768 .28 dot

199.* 229.* 269.*
 *(w/CPU Purchase) A word about High Resolution... all our ACP Leading Edge CPU's with SVGA (1024x768) card and the New AD type monitors give you High Res (1024x768) at a Low Res price!

Expansion Boards

Orchid Technology

RamQuest 16/32 w/OK228
 RamQuest 8/16 w/OK148

AST Research

SixPak 286 w/OK108
 Cupid 32 w/OK249

Boca Research

BocaRAM AT Plus w/OK (uses SIMM's) ...119
 BocaRAM AT Plus I/O w/OK149

Intel

Above Board 2 Plus w/2Mb435
 Above Board Plus 8 w/2Mb449

ACP

IDE Interface with I/O59.95
 (4)Floppy(2.88Mb) w/IDE adapter ...79.95
 IDE Interface with BIOS ROM65
 Serial interface card39.95
 Serial, parallel, game interface49.95
 2Mb EEMS AT memory board w/OK ...99.95

US Robotics Free Offer...

The Sierra Network startup kit: It's like cable TV for your PC, only better. You'll play games & have real conversations with other Sierra subscribers, with software, manual, list of sign-up numbers and usage credit, ...and includes the **Sportster Modem**. Sierra's standardized on the US Robotics modem from their end, we will send the start up kit FREE! with your purchase of the Sportster 2400 bps external or internal modem (compare to the ACP everyday low price of \$159 for just the Sportster)
Sportster bundled w/TSN kit\$129



Video Graphics Cards

ATI

Graphics Ultra w/512K & Mouse439
 Graphics Vantage w/512K & Mouse ...349
 VGA Stereo FX XL w/1Mb369
 VGA Wonder XL w/1Mb & Mouse238

Orchid Technology

ProDesigner IIs w/1Mb and RAMDAC .248
 Fahrenheit 1280 w/1Mb365

Unified Solutions

Image 800/16bit 256K 800x60069
 Image 1024 w/512K 1024x76889
 Image Ultra w/1Mb 1024 256 colors ...139
 Image HiColor w/1Mb 1280x1024159

Computer Hotline Hits

Specials are subject to prior sale...
 Magnavox 386SX/16 40Mb Bundle .795
 Magnavox Metalls Notebook1399
 •2 Mb•40Mb•Mousepen•Case•386sx•Stiffwe
 IBM OS/2 Extended v1.2 (3.5")99
 IBM OS/2 DisplayWrite 5/2. (5.25") ...149
 J. K. Lassers 1991 Tax plus Book9.95
Call for your copy of our quarterly tabloid "the ACP Computer Hotline"

Notebooks

Everex

The all new Tempo™ Carrier™ Notebook with 20 or 25MHz 386SX CPU,40or 80Mb hard drive.**Prices Slashed!**



I.Q. Engineering

2 Great Products!
Super Cartridge 3 Professional Edition
 72 scalable fonts and typefaces for HP LJ III. The only cartridge that prints **FASTER** than resident fonts
Professional Edition\$279

Creative Edition

31 typeface families and 66 scalable fonts. Type 1 compatible for your HP LJ III.
Creative Edition\$279

FAX Boards

Frecom

1-Liner Fax/Modem159
 1-Liner Fax/Modem for Windows199
 FAX96/Modem for Windows149

Diskettes

Fuji

ACP stocks complete Fuji Diskette line. All with Lifetime guarantee. Box (10) Call for color 5.25" HD Disks8.95 DS/DD Disks 5.50 3.5" HD Disks14.89 DS Disks7.99

Hayes

Optima Modem

New from Hayes, an affordable high performance modem with V.42 speed and throughput up to 9600 Baud. Includes SmartCom EZ.
Optima 24, 2400 Baud\$ 149
Optima 96, 9600 Baud\$ 369
Optima 96, for Mac\$ 369

New! 15,000 Software Titles

Call 900 "RUN THE BEST"
 (900-786-8432, set modem \$8.1) (98¢/minute, \$2.50 1st minute)
 •15,000 Downloadable Public Domain and Shareware Programs
 •Menu Driven •1200/2400 Baud
Try for FREE! 714-558-9423
 •Download Program of the Month FREE!
 •View and Download Catalog (24 hrs.)

Advanced Computer Products, Inc.

1310 E. Edinger, Santa Ana, CA 92705 • FAX 714-558-8849 • Toll-Free 1-800-FONE ACP • Sales 714-558-8813

No surcharge on credit card. Credit cards not charged until we ship. 100% risk free return guarantee! If you are not 100% satisfied just return insured within 15 days complete with all materials in new resalable condition with original invoice. ACP will immediately exchange product or issue ACP credit less shipping for future purchase. We ship UPS Ground. Next Day Air and FedEx available.

Circle 197 on Inquiry Card.



First Source will give you great memories!

IBM MEMORY

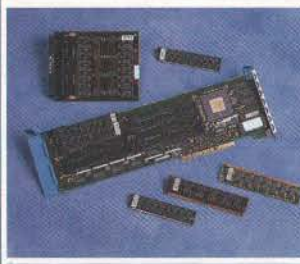

PS/1		
2MB	92F9935	\$104
PS/2 30/286, 1497259		
2MB Kit	30F5360	\$99
PS/2 35SX;LS,40SX,50Z,55SX;LS,65SX;LS,70		
1MB	6450603	\$51
2MB	6450604	\$95
PS/2 70-A21;A61;B21;B61		
2MB	6450608	\$95
PS/2 35SX;LS,40SX,55SX;LS,65SX;LS,34F30XX		
4MB	34F2933	\$169
PS/2 35SX;LS, 40SX		
8MB	6450129	\$369
PS/2 57SX, 90, 95		
8MB	6450130	\$369
PS/2 90, 95 and P75 (Install in pairs)		
4MB	6450128	\$169
Expansion boards for 50, 50Z, 55SX, 60, 65SX		
2-8MB w/2M	1497259	\$279
2-8MB w/4M	1497259	\$379
2-8MB w/6M	1497259	\$479
2-16MB w/2M	6450609	\$319
Expansion boards for all models 70 and 80		
2-14MB w/2M	34F3077	\$329
4-16MB w/4M	34F3011	\$429

SX/NOW! PROCESSOR UPGRADE

Kingston Technology Corp.'s SX-Now!
is the undisputed performance champ.

-PC Magazine October 29, 1991



Landmark Speed Test (1.1)

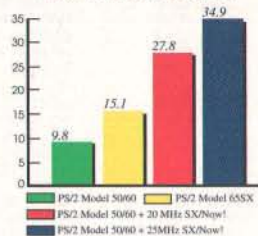

Don't replace your system...

Upgrade your 286 to a 386SX with Kingston's SX/Now!

SX/Now! 80386SX Processor features:

- ✓ Available in 20 or 25MHz
- ✓ 16K bytes of Cache Memory
- ✓ Onboard High Speed Clock
- ✓ Requires No Expansion Slot
- ✓ 80387SX Co-Processor Socket
- ✓ 5-Year Warranty

Now available for:

- ✓ IBM PS/2 25/286, 30/286, 50, 50Z, 60
- ✓ IBM Original AT & XT/286
- ✓ AST Premium 286 and Bravo 286
- ✓ Hewlett-Packard ES286/12 & ES/8
- ✓ Epson Equity Iie and II Plus
- ✓ NEC P.M. 286 Plus & Port. Plus
- ✓ AGI 1800A, 1800B, & 1800C
- ✓ Compaq Portable III, DeskPro 286



SX/Now! provides true multitasking and background operation for Windows 3.0, OS/2, and 386 specific software. Improves system performance up to 350%!

SX/Now! 20MHz Accelerator\$359
SX/Now! 25MHz Accelerator\$419

LAPTOP MEMORY



APPLE		
Powerbook 100, 140, 170	CALL	\$\$\$\$
AST		
Executive Notebook	4MB	\$169
COMPAQ		
Portable LTE386S/20	1MB	\$129
	4MB	\$289
Portable LTE 286	2MB	\$109
	4MB	\$209
SLT-286	1MB	\$99
	4MB	\$339
SLT-386	4MB	\$249
LTE Lite/20, 25	4MB	\$489
GRID		
1500 Series	4MB	\$249
IBM		
L40SX, N33SX Laptop	4MB	\$169
	8MB	\$369
MAGNAVOX		
Metalis	4MB	\$279
NEC		
UltraLite III	2MB	\$209
	4MB	\$459
	8MB	\$899
UltraLite SX/20	2MB	\$259
	8MB	\$789
UltraLite SL/20	2MB	\$229
	4MB	\$659
PANASONIC		
CF170/270/370	1MB	\$79
SANYO, EVEREX and ZEOS		
Notebook Memory	2MB	\$109
TOSHIBA		
T1000SE/LE/XE, T2000SX &	2MB	\$119
T1000LE, T2000SX, T2000SX	4MB	\$279
	8MB	\$549
T1200XE, T1600, T3100E	2MB	\$105
T3100SX, T3200SX, SXC	2MB	\$105
	4MB	\$169
T3200	3MB	\$179
T4400, T6400	2MB	\$229
	4MB	\$349
	8MB	\$789
T5100	2MB	\$115
T5200, T5200C, T6500	2MB	\$115
	8MB	\$369
ZENITH		
MastersPort 386SL	2MB	\$159
MastersPort 386SX	2MB	\$169
S.S. SX, 286E, SlimsPort	2MB	\$149
SupersPort SX	2MB	\$149
SupersPort 286, 286E	1MB kit	\$109
SupersPort 286E, SlimsPort	4MB	\$439
TurbosPort 386, 386E	1MB	\$159

NEC MEMORY

Powermate SX Plus		
1-2MB Brd	APC-H850E	\$179
4-8MB Brd	APC-852E	\$559
Powermate SX/20		
2MB CPU	OP-410-8101	\$189
2MB Brd	OP-410-8102	\$209
Powermate 386/20, 25		
8MB	APC-H655	\$899
Powermate 386/33; 486SX/C,		
T Express Series (Install in Pairs)		
1MB	OP-410-6204	\$99
4MB	OP-410-6205	\$279
16MB	OP-410-6206	\$999

PRINTER MEMORY

Hewlett-Packard LaserJet IIF, III, IIIP, IIID		
2MB	33475B	\$119
4MB	33477B	\$189
Hewlett-Packard LaserJet II and IID		
2MB	33444B	\$125
4MB	33445B	\$195
Hewlett-Packard DeskJet 500 and Plus		
256K	22707B	\$59
IBM Laser 4019 and 4019e		
2MB	1039137	\$129
3.5MB	1038675	\$189
IBM Laser 4029 All Models		
2MB	1183334	\$159
4MB	1183335	\$219
Canon LBP-4		
2MB	PN N/A	\$229
Brother HL-8, 8E, 8D, 8V		
2MB	MB-820	\$169
Panasonic 4450I and 4420		
2MB	KX-P441	\$129
4MB	PN N/A	\$219
Toshiba Page Laser 6		
4MB	LS6-NB0100	\$199
Okilaser 400		
2MB	OKI PN N/A	\$129
Texas Instruments MicroLaser and XL		
1MB	2555739-0001	\$69
Epson EPL 6000		
2MB	IBS401	\$129
Epson Action Laser II		
2MB	PN N/A	\$279

COMPAQ MEMORY

DeskPro 386-20, 20E and 25		
4MB	113132-001	\$179
DeskPro 386S/16		
4MB	112534-001	\$179
DeskPro 286N, 386N		
DK Board	118700-001	\$89
DeskPro 286N, 386N, 386SX/20, 386/25M,		
486/33M, 486S/25M, 486S/16M; SystemPro LT,		
486SX/25S; 386/25S; Portable 486c		
1MB	118588-001	\$59
2MB	118689-001	\$99
4MB	118690-001	\$179
DeskPro 386-33, 486-33 and SystemPro		
2MB	115144-001	\$129
8MB	116561-001	\$329
DeskPro 386-20e and 25e		
4MB Board	113645-001	\$249
DeskPro 386S		
4MB Board	113634-001	\$279
DeskPro 386M, 486M, SystemPro LT		
32-Bit, 8-Slot Expansion Board		
2-64MB w/2M	129160-001	\$379
4-64MB w/4M	129160-001	\$469
8-64MB w/6M	129160-001	\$559

HP MEMORY

Vectra QS/16S; 20PC, RS/20PC; 25PC, 20C		
4MB Kit	D1542/1642A	\$199
Vectra 386/16N, 386/20N		
2MB	D2406A	\$139
8MB	D2404A	\$339
Vectra 486 PC (Install in Pairs)		
4MB	D2151A	\$179
Vectra 386/25, 486/25T, 33T (Install in Pairs)		
2MB	D2381A	\$99

ZENITH MEMORY

Zenith Z-386/20/25/33 and 33E		
1MB	ZA-36/3800-ME	\$59
4MB	ZA-3800-MK	\$179
Zenith Z-386SX, 286PL+, Z-LS		
2MB	Z-605-1	\$99
Zenith 486/25E		
4MB	ZA-4100-ME	\$219

SIMM / DRAM

SIMMS AND SIPPS		DRAM CHIPS	
4MX9-80	\$138	1X1-80	\$4.50
1MX9-80	\$40	256X4-80	\$5.00
256X9-80	\$15	256X1-80	\$1.80

AST MEMORY

Premium 386, 386-20		
4MB Kit	500510-004	\$239
Bravo 386-SX, WS/286, 386		
2MB Kit	500510-002	\$99
4MB Kit	500510-008	\$189
Premium 386/25;33, Premium II 386SX/16;20		
1MB w/WPB	500780-003	\$69
All Premium and Bravo 486 Models		
8MB w/WPB	500780-001	\$339
Premium II 386SX/20 and 386SX/16		
4MB w/WPB	500780-004	\$169

EXPANSION BOARDS

BocaRam/AT Plus	
Up to 8MB for AT or 16-bit compatibles running up to 33MHz. Provides Conv., Expanded and/or Extended LIM/EMS 4.0.	
2MB with DRAM\$185	

Please call for any item not listed.

We also stock memory for Acer, ALR, Apple, Arche Technologies, AT&T, Austin, Bondwell, Chinon, Clitzon, Commodore, CompuAdd, Data World, Dell, DTK, Everex, Gateway, GRID, Hyundai, Intel, Leading Edge, Magnavox, Micro Express, Midem, Mips, Mitsubishi, NCR, NeXT, Northgate, Olivetti, Packard Bell, PC Brand, Poaget, Samsung, Silicon Graphics, Smith Corona, Swan, Tandy, Unisys, Wang, Wyse, Zeos and Others.

Outside the U.S.

1-714-588-9866

Business hours: Monday-Friday 8AM - 5PM

Mail orders to: 36 Argonaut, Suite 140 Aliso Viejo, CA 92656 USA

Price, Quality, and Support

- Same Day Shipping • Overnight and Saturday Delivery Available •
- All Products User Installable • Free Technical Support • No Surcharge on Visa, Mastercard, or Discover • APO/FPO/International Orders Welcome • Purchase Orders Accepted from Gov't, Universities, and Qualified Firms •



"The Only Source for Computer Memory!"

Order Toll Free from anywhere in the U.S. or Canada

1-800-535-5892



Fax Line

1-714-588-9872

Fax your orders 24 hours a day, 7 days a week!
Call or fax for a FREE catalog.

Delivery Guaranteed

Follow your package every step of the way with 3 day international delivery via Federal Express, UPS, or DHL. Fast, inexpensive, dependable delivery anywhere in the world! Information on tracking shipments is available at your request.



Terms and Conditions: All products are third party and manufacturer's part numbers are for your convenience. All products carry a full manufacturer's warranty. All products are guaranteed 100% compatible or your money back. All freight charges are non-refundable. A 20% restocking fee will be charged on all non-defective returns, unopened, and resold or cancelled orders. All items must be returned within 15 days with original documentation and packaging. Returned Merchandise Authorization number is required. Prices and availability are subject to change without notice. Minimum order of \$50. All purchase prices at the time of order are final. First Source International cannot be responsible for errors in typographic or photography. We will beat any advertised price paid only on identical brands, offer not good for SIMMs or DRAM. All trademarks and registered trademarks are of their respective companies.

Monthly Specials!!

MICRO-L™ ISA 486-50 CACHE (Symphony) \$2,895

- Intel 80486-50MHz Processor
- AMI BIOS, Symphony™ Chipset, Dallas DS1287 real-time clock (w/10-year warranty) • 256K Cache SRAM exp. to 1MB
- 8MB RAM 60ns expandable to 32MB onboard
- 1 2MB & 1 44MB Floppy Disk Drives (TEAC)
- 210MB, 15ms, 64K Cache IDE HDD • IDE HD/FD Controller
- Diamond Stealth1280 Card, 1MB VRAM, 16-bit VGA card, Hi Sierra color (up to 25 times faster than standard VGA)
- 14" Super Multiscan, 1024x768, non-int., 0.28dp. (Relisys-1422)
- 1 Parallel / 2 Serial Ports • Keytronics 101 Keyboard (USA)
- Mid Tower case (Heavy duty), 230W UL P/S & digital display
- MS-DOS 5.0 • MS-Windows 3.1 and MS compatible mouse
- OPTION: Sony CPD 1304S/1604 monitor - add \$265/675
- OPTION: Nanao 90801/T5601 monitor - add \$735/1595
- OPTION: Full Tower - 10-bays, 275W P/S - add \$75

MICRO-L™ ISA 486-33 CACHE (Symphony) \$2,035

- Intel 80486-33MHz Processor - Upgradable to 50MHz; Socket for removable crystal allows for CPU changes
- AMI BIOS, Symphony™ Chipset, Dallas DS1287 real-time clock (10yr warranty) • 4MB RAM 70ns exp. to 32MB onboard
- 256K Cache SRAM expandable to 1MB • 1.2MB and 1.44MB Floppy Disk Drives (TEAC)
- 130MB, 15ms, 64K Cache IDE HDD • IDE HD/FD Controller
- SpeedStarPlus, 1MB, 16-bit VGA card, Hi Sierra color
- 14" Super Multiscan, 1024x768, non-int., 0.28dp. (Relisys-1422)
- 1 Parallel / 2 Serial ports • Keytronics 101 Keyboard (USA)
- Mid Tower case (Heavy duty), 230W UL P/S & digital display
- MS-DOS 5.0 • MS-Windows 3.1 and MS compatible mouse
- OPTION: 210MB IDE HDD - add \$235
- OPTION: Sony CPD-1304 monitor add - \$265

MICRO-L™ 386-33 CACHE (Symphony) \$1,595

- Intel 80386-33MHz CPU - Upgradable to 40MHz; Socket for removable crystal allows for CPU changes
- AMI BIOS, Symphony™ Chipset, Dallas DS1287 real-time clock (w/10 year warranty)
- 64K Cache SRAM exp. to 1MB onboard (Option: 256K Cache - add \$65) • 4MB RAM 70ns exp. to 32MB onboard
- 130MB, 15ms IDE Hard Disk Drive • HDD/FDD controller
- 1.2 & 1.44MB FDDs (TEAC) • 1 Parallel / 2 Serial / 1 Game ports
- 14" Super Multi-scan, non-int., 1024 x 768, 0.28dp (Relisys RE-1422) • 16-bit VGA Card with 1MB onboard
- Deluxe Baby Case with 200W UL power supply, 6-bays
- Keytronics 101 Keybd (USA) • MS-DOS 5.0
- MS-Windows 3.1 and MS compatible mouse
- OPTION: 386-40 SVGA system - add \$45
- OPTION: Mid-Tower - add \$60

MICRO-L™ 386-25 (Symphony) \$1,395

- Intel 80386-25MHz Processor - Upgrades to 33MHz/40MHz; Socket for removable crystal allows for CPU changes
- AMI BIOS, Symphony™ Chipset, Dallas DS1287 real-time clock (10yr warranty) • 4MB RAM 70ns exp. to 32MB onboard
- 80MB, 17ms IDE Hard Disk Drive • HDD/FDD controller
- 1.2 & 1.44MB FDDs (TEAC) • 1 Parallel / 2 Serial / 1 Game ports
- 16-bit VGA Card with 1MB onboard (Trident)
- 14" Super VGA, 1024 x 768, 0.28dp (Relisys-1420)
- Deluxe Baby Case with 200W UL power supply, 6-bays
- Keytronics 101 Keybd (USA) • MS-DOS 5.0
- MS-Windows 3.1 and MS compatible mouse
- OPTION: 386-33 SVGA system - add \$35
- OPTION: 386-40 SVGA system - add \$65
- OPTION: Mid-Tower - add \$60

MICRO-L™ 386-SX/20 SVGA \$1,195

- Intel 80386-SX/20MHz Processor • AMI BIOS
- 2MB RAM expandable to 8MB onboard
- 1.2 & 1.44MB FDDs (TEAC) • 1 Parallel / 2 Serial / 1 Game ports
- 40MB IDE Hard Disk Drive • HDD/FDD controller
- 16-bit VGA card with 512K onboard (Flicker Free)
- 14" SVGA Monitor, 1024 x 768, 0.28dp. (Relisys RE-1420)
- Keytronics 101 Keyboard (USA) • MS-DOS 5.0
- MS Window 3.1 and MS compatible mouse
- Deluxe Baby Case with 200W UL power supply, 6-bays
- OPTION: 386SX-25 64K Cache, SVGA system - add \$60
- OPTION: 386SX-25 SVGA system - add \$60
- OPTION: 80MB IDE HDD - add \$95

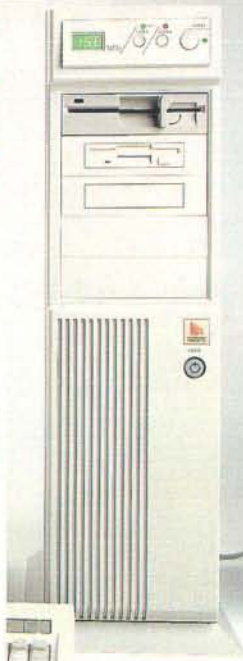

* The Intel Inside Logo is a trademark of Intel Corporation.

Standard System Features:

- (Unless specified differently in Specials)
- Motherboard - Intel CPU
- 4MB 70ns RAM on-board
- Math co-processor socket
- 1.2MB and 1.44MB FDDs (Teac)
- Dual IDE HDD/FDD controller
- 2 serial/1 parallel/1 game ports
- 101 Keytronics keyboard
- Desktop case w 200W UL / PS

- OPTIONS:Mid-Tower add-\$60
- Full-Tower add-\$100

We offer superior products, and the best values in the industry at unbeatable prices!

Intelligent Choices



You May Recognize Some of Our Customers...

- | | | | |
|------------------------------------|-------------------------|------------------------------------|-----------------|
| Intel Corporation | U.C. Berkeley | U.S. Naval Department | S.W. Bell |
| M.I.T. | Procter & Gamble | U.S. Marine Corps | DuPont Exxon |
| PG & E | Digital Equipment Corp. | U.S. Army | Washington Post |
| AT & T | Clemson University | U.S. Veterans Hospital Admin. Ctr. | |
| N.A.S.A. | Xerox Eastman Kodak | Lawrence Livermore Laboratories | |
| Lockheed Missile Space Engineering | | ...and the list goes on and on... | |

MICRO-L™ SYSTEMS: (Prices below do not include HDD, monitor / card)

- 486-33 EISA w/256K cache (Micronics MB) \$1,745
- 486-50 ISA w/256K cache (MCI/Symphony) \$1,295
- 486-33 ISA w/256K cache (MCI/Symphony) upgradable to 50MHz \$1,065
- 486SX/20 w/64K cache (Symphony) upgradable to 33MHz/50MHz \$795
- 386-33 w/64K cache, (Symphony) upgradable to 40MHz \$695
- 386-25 (Symphony) upgradable to 33MHz/40MHz \$635
- 386-SX20 or 386-SX16 \$595/\$575
- MICRO-L Notebook 386-SX-V20 Vanda, 2MB RAM, 40MB HDD, 1.44 FDD, 1P & 1S ports, 32 Grey scale VGA, 6.2lbs..... \$1,435

MOTHERBOARDS

- 486-33 EISA 256K cache/Micronics \$1350
- 486-33/50 & 486SX-20

MICRO-L™ Symphony Spec:

- Symphony Chipset - CPU socket accepts 486-33/50 & 486SX-20
- AMI BIOS & Weitek 4167 math-co-processor
- Up to 32MB SMM RAM on board
- Removable crystal allows for CPU changes
- UP to 1MB direct map cache
- Dallas DS1287 real-time clock (10yr warranty)
- Seven 16-bit and One 8-bit expansion slots
- Baby size board: 8.5in x 13.1in
- 486-50 ISA 256K cache, Symphony \$895
- 486-33 AT 256K cache, Symphony \$645
- 486-SX/20 64K cache, Symphony \$385
- 386-33/40 64K cache, Symphony \$315/345
- 386-25/33 Symphony \$245/265
- 386-SX25 64K cache \$245
- 386-SX20 /16 \$179/159
- 286-16 \$85

MONITORS

- Hitachi CM-2085, VGA, 20" \$1625
- IDEK VGA 5217(17")/5221(21") \$985/2395
- Nanao 16" VGA 1024x768 90801 \$1065
- Nanao 20" VGA 1024x768 T5601 \$1865
- Nanao 20" VGA 1280x1024 94001 \$2065
- NEC 3FGX/4FG/5FG \$695/805/1435
- Relisys S Multiscan, 1024x768 RE-1420 \$295
- Relisys S Multiscan, NI, 1024x768 RE-1422 \$360
- Sony 16" SMultiscan, CPD 1604S \$995
- ViewSonic Ve/V7 VGA \$375/1245
- ATI UltraGraphic VGA 1MB \$535
- Diamond Stealth 1280, 1MB VRAM \$290
- Orchid ProD IIs 1MB, w/Hi Sierra \$178
- Orchid Fahrenheit 1280, 1MB \$280
- SpeedStar+ VGA 1MB, w/Hi Sierra \$178
- Vermont Dynamaster VGA 1MB \$345

HARD DRIVES

- Maxtor MXT-7080A 81MB IDE \$295

- Maxtor MXT-7120A/S 130MB \$365
- Maxtor LXT-340A 340MB IDE \$595
- Maxtor LXT-340A 340MB IDE \$885
- Maxtor XT-8380SH 380MB SCSI \$1075
- Maxtor XT-8760SH 768MB \$1345
- Maxtor 102 GB/1 47GB SCSI \$1895/2295
- Conner CP-3204 200MB \$590
- Quantum ProDr120AT 120MB, 15ms \$375
- Quantum ProDr240A/S 210MB, 14ms \$615
- Adaptec 1542B - Kit SCSI Ctrlr FD/HDD \$260

MISCELLANEOUS

- 3-COM 3C503 Etherlink \$185
- Colorado DJ-10/DJ-20 Tape BK \$230/285
- American Smart UPS 600LS/400LS \$415/335
- Summa Sketch II+ 12"x12" Digitizer \$325
- Kurta IS1212 ADB 12" x 12" tablet \$345
- US Robotics Sport 9600 int./ext. \$345/375
- US Robotics 9600 Courier HST ext. \$555
- FAX modem 9600 send/recv/software \$95

- We offer competitive prices, superior products, customer support, and the best values in the mail order industry. In addition, we offer:
- 30-day money-back guarantee for defective items.
- One-year Warranty (Labor & Parts)
- Prices reflect 3% cash discount.
- Shipping non-refundable on returned items. RMA # is required.
- California residents add 8 1/2% sales tax.
- Allow 10 working days for checks to clear.
- 15% re-stocking fee on non-defective returns.
- Government, University & Fortune 1000 P.O. s- Net 30 add 3%.
- Opened software is not returnable.
- We welcome international accounts, minimum order: \$250.
- ARO's, FPO's, & Overseas orders welcome.
- Prices subject to change without notice.
- All trademarks belong to their respective companies.
- We are not responsible for typographical errors.

Hours: Mon thru Fri - 7:30 to 6:00pm (PST)
Sat - 10:00 to 4:00pm (PST)

Formerly known as
MICROLINE Computers
MICROLANE COMPUTERS
INCORPORATED
46757 Fremont Blvd., Fremont, CA 94538

Orders Only **1-800-777-2219**

Info/CA Orders: (510) 770-1900
Fax: (510) 770-1912

Dealer Inquiries Welcome.

Government, Corporate & University P.O.'s Welcome!



For your protection, we check thoroughly for stolen credit cards.

Microlane Computers - Taiwan

Phone: 011-886-7-345-0025
Fax: 011-886-7-345-0060

PCI Means Smart Buy!



PCI Desktop systems are powerful and affordable. You will find a wide range of systems from 386SX to 486DX-33 to suit your business need.

- PCI 386SX-25Mhz**
- 4MB RAM
 - 1.2 & 1.44MB FD
 - 85MB IDE Hard Drive
 - SVGA Card w/ 1MB RA
 - 14" Non-interlaced SVG Color Monitor
 - 2 Serial/1 Parallel/1 Gan
 - 101 Key Keyboard

\$1345

FREE DOS 5.0 and Microsoft Window 3.0 and Mouse with Each System

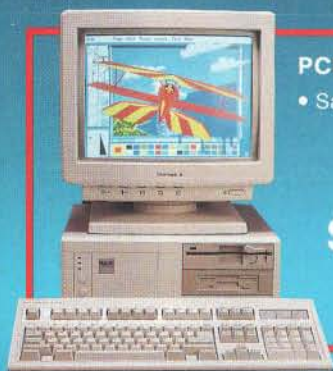

- PCI 386-25Mhz**
- Same as above

\$1445



- PCI 386-33Mhz**
- 4MB RAM
 - 64K Cache
 - 120MB Hard Disk

\$1695



- PCI 486-33Mhz**
- 256K Cache
 - 210MB Hard Disk

\$2295

If you want a good quality computer system with the best price, PCI is definitely the one to go. We stand behind every system that we sell with unbeatable service. With the 30-day money back guarantee and the on-site service by **Nationwide**, you as a customer are safely protected.

Presenting PCI Portable Computer Systems — Desktop power on the road. It comes with both LCD and Gas Plasma Screen. With its vivid VGA resolution and 4 1/2 expansion slots in each system, you are working with power!

PCI LCD VGA Portable

- 386SX-25Mhz
- 2MB RAM
- 1.2 & 1.44MB FD
- 85MB Hard Drive
- LCD 640 x 480 Screen
- LCD VGA Display
- Serial and Parallel
- 86 Key Detachable Keyboard
- 200W Power Supply
- Free Carrying Bag



\$1495

Call for Price on Other 486s, 386s, and Gas Plasma Models

**CALL TOLL FREE
800-346-7207**

- Free 1 Year On-site Service
- Lifetime Toll Free Technical Support
- 30 Days Money Back Guarantee
- 2 Years Labor and 1 Year Parts Warranty

- Build Quality Computers Since 1983
 - Fortune 1000 Companies, Universities and Government Purchase Orders Welcome
- Circle 242 on Inquiry Card.**

OFFICE HOURS: MON-SAT 8:30 AM - 5:30 PM PST

Price Subject to Change without Notice

COMPUTER WAREHOUSE



9945 Lower Azusa, Temple City
CA 91780 / Fax: 818-442-9112

TWO COMPUTERS CAN SHARE ONE BACKPACK.

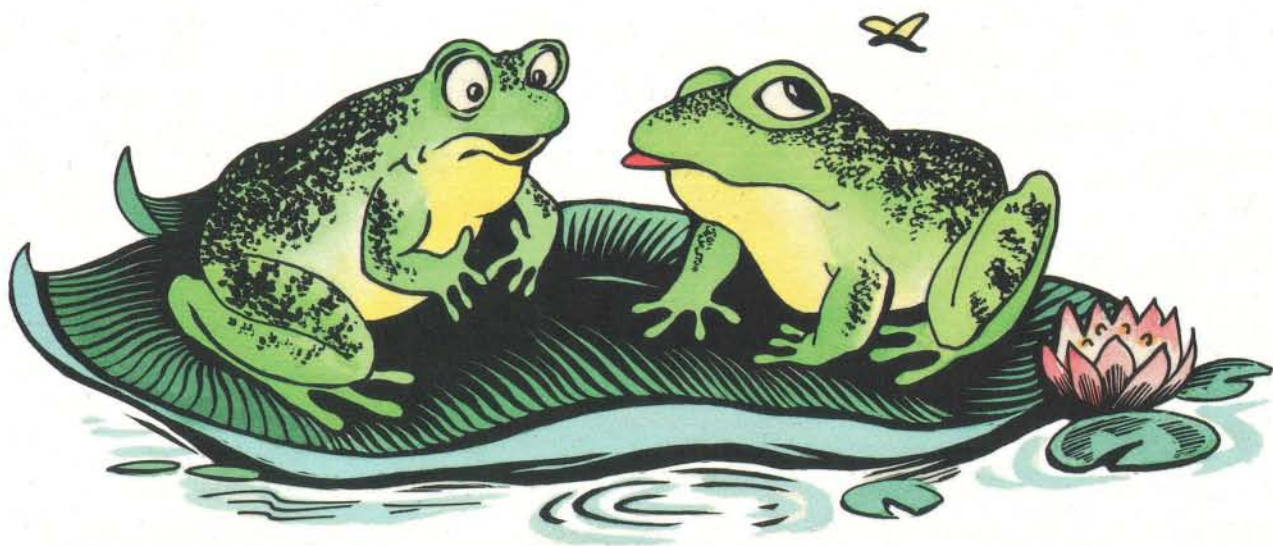

With Backpack, several computers can share a single tape drive. Backpack connects quickly and easily to the parallel printer port of any PC compatible or portable—without interface cards or tools! The Backpack tape drive is also easy to transport, making it ideal for trans-

ferring data from one computer to another. QIC 40 (40/120MB) and QIC 80 (80/250) tape, diskette and hard drive models are available. So share and share alike! Call today for more information.



backpack

MicroSolutions
Computer Products

132 W. Lincoln Hwy., DeKalb, IL 60115 815-756-3411 Fax 815-756-2928



SPRING CLEARANCE (Thru 7-15-92)



2MB MODULES

for model 50, 50Z, 555X, 60, 655X, 70, 355X, LS, 405X. Specify Equivalent part # 6450604, 6450608, 30F5360. We guarantee compatible to part #'s. 1 year warranty

\$94 each



4 MEG MODULES

For 386SX, 386S, 386-20, 25, 286E. Specify Equivalent part # 113132-001, 118690-001, 112534-001. We guarantee compatible to part #'s. 1 year warranty.

\$198 each

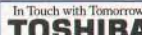

2 MEG MODULES

In Touch with Tomorrow
2 MEG modules for 1200XE, 1600, 3100E, 3100SX, 3200SX, 3200SX, 5100, 5200, 8500. Specify machine. 1 year warranty.

\$109

SIMM MODULE BLOWOUT

QTY	1-32	39.00	1 MEG X 9 80NS SIMM MODULE.
	32-128	38.00	
	128-256	37.00	
	256+	36.00	



LASERJET 2MB

MEMORY BOARD 2MB for II & IID & Cannon LPBIII, IIR, IIT. **\$79**



Advantage/2 for PS2, 50 or 60. 2-MEG, Super Pack Utility Software. 2Meg **\$149** 4MEG **\$199** 8MEG **\$399**

COMPUTER PERIPHERALS INC. 2MEG exp 4MB

16 Bit. 2MB expandable to 4MB. (Uses 1MB x 1 Dips) Works with IBM PCXT, AT, 386 and compatibles. Expanded, Extended, 4.0 Lim compatible. **2MEG \$89** **4MEG \$159**

WE SPECIALIZE IN CLOSEOUTS & LIQUIDATIONS OF CURRENT PRODUCTS BELOW DEALER COST

SOFTWARE

WORDSTAR 6.0 or 2000 REL. 3.5

This is not a misprint! These are the exact same ones selling for over \$300.00 from our competitors. We have thousands in stock FOR SALE BELOW DISTRIBUTOR COST! LIST \$495.00 ea DEALERS WELCOME

\$99 CURRENT VERSIONS \$99

MONITORS

12" GREEN MONOCHROME Tilt & Swivel Base.....	
14" MONO/TTL AMBER FLAT SCREEN.....	\$99.00
14" VGA..... 640X480..... [41 Dot].....	\$229.00
14" VGA..... 1024X768..... [28 Dot].....	\$289.00
14" VGA..... 1024X768..... [Non Interlaced].....	\$349.00
VGA CARD..... 256K Exp 1MEG.....	\$79.00

HAND SCANNER

Marstek info 5" 400 DPI. La Palette software for scanning, drawing, editing, painting, and printing. FREE OCR INCLUDED! **YOUR COST \$89**

HARD DRIVES

PART#	SIZE	ACCESS TIME	INTERFACE	YOUR COST
8087-20MB	20MB	65MSec	MFM	99.00
8087-20MBI	21MB	65MSec	IDE	129.00
8087-40MB	44MB	28MSec	IDE	209.00
8087-40MBI	40MB	28MSec	MFM	229.00
8087-80MB	80MB	18MSec	IDE	269.00
8087-80MBI	80MB	28MSec	MFM	339.00
8087-105MBI	105MB	22MSec	IDE	299.00
8087-120MB	120MB	18MSec	IDE	399.00
8087-210MBI	200MB	18MSec	IDE	649.00
8087-330MBI	330MB	18MSec	IDE	1,195.00

(All Hard Drives have a 1 Year Warranty)

CONTROLLERS

IDE HD/Floppy **39.00**, 16 Bit HD & FLOPPY 1:1 **39.00**, 8 Bit HD only **49.00**
FOR FLOPPYS: Super Floppy Controls 1, 2, 360K, 720K & 1.44 Drives **49.00**

COPROCESSORS

8088 BASED MACHINES:	8087-6MHz 54.00	8087-8MHz 79.00	8087-10MHz 129.00	8087-10MHz 129.00
8086 BASED MACHINES:	80387-16 16MHz 149.00	80387-20 20MHz 179.00	80387-25 25MHz 189.00	80387-33 33MHz 199.00
	80387-5X16 124.00	80387-SX20 144.00	80487-SX20 549.00	

5 Year Warranty MODEMS 5 Year Warranty

BOCA RESEARCH INC. Boca Modem 2400 Baud Hayes compatible; supports extended AT Command Set. Comm 1-4 & IRQ 3-5 & 7. On board speaker, software & telephone cord. **Internal \$49 External \$79** V.42 BIS MNP5 Hardware add \$30

BOCA RESEARCH INC. Boca Fax Modem Send & receive 9600 BPS fax & 2400 BPS Modem. Hayes compatible. On board speaker. Mirror fax software. Part address Com 1-4. **\$88** 14.4 Baud V.32 Bis Add \$200

TAPE BACKUPS

WANGTEK Wangtek 5099EN24 drive, 6.5MB per minute, PC 36 Controller, Menue Driven Software, Easy installation, DC 600 cartridge List \$999.00 **YOUR COST \$379**

3M DC 2000 (40MB) **13.00** DC 300XP (45MB) **17.00** DC 6150 **20.00**

FLOPPY DRIVES

MITSUBISHI	360K Full HT 5 1/4 "	\$19
EPSON	360K 1/2 HT 5 1/4 "	\$39
	720K 3 1/2 "	\$29
	1.2MB 3 1/2 "	\$58
	1.44MB 3 1/2 "	\$59
	5 1/4 " Brackets	\$5

NEW REDUCED PRICING ON OUR LARGE SELECTION OF MEMORY PRODUCTS

MODEL	MEMORY ADDED	COMPAQ EQUIV. PART#	YOUR COST
DESKPRO 286	1MB MODULE	118688-001	59.00
286N, 386N, 386SX/20	2MB MODULE	118689-001	109.00
	OK BOARD	118700-001	98.00
	4MB MODULE	118690-001	199.00
DESKPRO 386/16	1MB-2MB BOARD	108069-001	299.00
	2MB BOARD	108069W71	348.00
	1MB KIT	108071-001	114.00
	4MB-8MB BOARD	108070-001	545.00
	4MB KIT	108072-001	259.00
DESKPRO 386S	1MB BOARD	113633-001	120.00
	4MB BOARD	113634-001	269.00
	1MB MODULE	113646-001	79.00
	4MB MODULE	112534-001	209.00
DESKPRO 386/20, 25, 286E	1MB MODULE	113131-001	59.00
	4MB MODULE	113132-001	199.00
DESKPRO 386/20E/25E	1MB BOARD	113644-001	129.00
	4MB BOARD	113645-001	279.00
DESKPRO 386/33, 486/25/33/33L	2MB MODULE	115144-001	128.00
	8MB MODULE	116561-001	389.00
SYSTEMPRO 32MB MODULE	116568-001		2950.00

TOSHIBA MODEL	MEMORY ADDED	TOSHIBA EQUIV. PART #	YOUR COST
T1000SE & XE/IE	1MEG	PC14-PA8311U	119.00
T1000SE & XE/IE	2MEG	PC14-PA8312U	169.00
T2000SX	1MEG	PC18-PA8314U	114.00
T2000SX	2MEG	PC18-PA8317U	179.00
T2000SX/T1000E	4MEG	PC-PAB314U	309.00
T2000SX/T1000E	8MEG	PC-PAB315U	609.00
T2000SX/2200SX	2MEG	PC-PA2000U	179.00
T2000SX/2200SX	4MEG	PC-PA2001U	309.00
T2000SX/2200SX	8MEG	PC-PA2002U	619.00
T1200XE	2MEG	PC13-PA8306U	109.00
T1600	2MEG	PC8-PA8302U	109.00
T3100E	2MEG	PC9-PA83401U	109.00
T3100SX	2MEG	PC15-PA8308U	109.00
T3100SX	4MEG	PC15-PA8310U	195.00
T3200	3MEG	PC4-PA7137U	195.00
T3200SX	2MEG	PC12-PA8307U	109.00
T3200SX	4MEG	PC12-PA8309U	195.00
T3200SX/C	2MEG	PC19-PA8318U	109.00
T3200SX/C	4MEG	PC19-PA8319U	209.00
T5100	2MEG	PC7-PA8301U	109.00
T8500 or T5200 & T5200C	2MEG	PC10-PA8304U	109.00
	8MEG	PC10-PA8313U	419.00

IBM PS/2 MEMORY	MEMORY ADDED	IBM EQUIV. PART#	YOUR COST
IBM PS/2 MODEL # PS/1, 386SX	2MB	9297935	119.00
30-286	512K KIT	30F5348	38.00
	2MB KIT	30F5360	94.00
140SX & N33SX LAPTOP	2MEG	79F0999	108.00
	4MEG	79F0900	208.00
	8MEG	79F0901	418.00
50Z & 555X, 655X	1MB SIMM	6450603	179.00
	2MB SIMM	6450604	94.00
405X, 555X, 655X, 355X, 3515	4MB MODULE	34F2933/87F9977	189.00
50, 50Z, 555X 860, 655X	2-8MB BOARD	1497259/6450609	349.00
355X, LS, 405X	1MB SIMM	6450603	59.00
70-E61, 061, 121, P70	2MB SIMM	6450604	94.00
70-A21 A61, B21, B61	2MB SIMM	6450608	109.00
80-041	1MB MODULE	6450375	98.00
80-111, 121, 311, 321	2MB MODULE	6450379	129.00
80-A21, A31	4MB MODULE	6451060	229.00
355X, LS & 405X	8MB	6450129	468.00
ALL 70s & 80s	2-14MB BOARD	34F3077	358.00
	4-16MB BOARD	34F3011	488.00
575X, 90, 95, P75	2MB	6450902	115.00
	4MB	6450128	199.00
	8MB	6450130	469.00

PORTABLE III	512K KIT	107331-001	38.00
	INTFC BD <td>107808-001</td> <td>149.00</td>	107808-001	149.00
	EXP BD <td>107811-001</td> <td>249.00</td>	107811-001	249.00
	2MB KIT <td>107332-001</td> <td>119.00</td>	107332-001	119.00
SLT/286	1MB MODULE <td>110235-001</td> <td>119.00</td>	110235-001	119.00
	4MB MODULE <td>110237-001</td> <td>409.00</td>	110237-001	409.00
LTE/386	512K KIT <td>110707-001</td> <td>149.00</td>	110707-001	149.00
	1MB	121125-001	149.00
	4MB	121125-002	339.00
LTE/286	1MB BOARD <td>117081-001</td> <td>79.00</td>	117081-001	79.00
	4MB BOARD <td>117081-003</td> <td>318.00</td>	117081-003	318.00
PORTABLE 386	1MB KIT <td>107651-001</td> <td>169.00</td>	107651-001	169.00
	INTFC BD <td>107707-001</td> <td>129.00</td>	107707-001	129.00
	4MB BOARD <td>107653-001</td> <td>469.00</td>	107653-001	469.00
	4MB EXT BRD <td>107654-001</td> <td>469.00</td>	107654-001	469.00
SLT/386	1MB MODULE <td>118303-001</td> <td>129.00</td>	118303-001	129.00
	2MB MODULE <td>118304-001</td> <td>179.00</td>	118304-001	179.00
	4MB MODULE <td>118305-001</td> <td>349.00</td>	118305-001	349.00

BOCA MEMORY BOARDS
5 YEAR WARRANTY
80286 & 386 AT MACHINES - BOCA AT PLUS (BRAT 80) OK-8MEG BD. 4.0 LIM COMPATIBLE. CONVENTIONAL, EXPANDED & EXTENDED MEMORY. SUPPORTS DOS, OS/2, LIM, EMS & EEMS.
OK-99.00 2MEG-169.00 4MEG-249.00 8MEG-389.00
BRAT 90 - SAME EXCEPT USES SIMMS ADD 20.00.
BOCARAM/2 PLUS
16 BIT MEMORY FOR ALL IBM MCA SYSTEMS. DOS & OS/2 LIM EMS 4.0 SUPPORT. 2-8MB USES 1 MB SIMMS. 2MB \$194 4MB \$279 8MB \$449

DESCRIPTION	150NS	120NS	100NS	80NS	70NS	60NS
64X1	1.20	1.45	1.65			
64X4	1.95	2.25	2.45	2.95		
256X1	.05	1.05	1.10	1.15	1.45	
256X4		3.95	4.45	4.95	5.45	5.95
1MEGX1		3.50	3.85	4.10	4.45	4.95

MODEL	MEMORY ADDED	H.P. EQUIV. PART#	YOUR COST
HP II & III	2MB MODULE	334448	99.00
	4MB MODULE	334458	149.00
HP II	2MB MODULE	33475A/B	109.00
	4MB MODULE	N/A	169.00
HP III	1MB MODULE	N/A	79.00
	4MB MODULE	N/A	229.00

ORDERS ONLY
800-654-7762
You can Fax orders over also
TECHNICAL/CUSTOMER SERVICE/ORDER STATUS:
(702) 294-0204 FAX (702) 294-1168
HOURS: M-F 7:00-6:00 PST, SAT 10:00-3:00 PST

Mfg. part #'s for convenience only. Most memory products 3rd party.
WE ACCEPT INTERNATIONAL ORDERS
International orders shipped DHL or Air Mail
WE ALSO PURCHASE EXCESS INVENTORY! FAX OR CALL.
ALL PRICES FINAL. Trademarks are registered with their respective Co.'s. 386, 387, 287, 5X, are trademarks of Intel Corp.
NEVADA COMPUTER

TERMS:
NO SURCHARGE FOR MC/VISA
MC, VISA, AE, COD CASH, NET
Purchase orders from Universities
Fortune 1000 & Government Agencies
Personal Checks, COD add \$5.00
20% Restocking Fee on refunds within 30 days
No refunds or exchanges after 30 days - WARRANTY REPLACEMENT ONLY
AD # B692
PRICES SUBJECT TO CHANGE
SHIPPING: UPS (Min. \$8.25)
684 Wells Road, Boulder City, Nevada 89005

SmartCache™ Plus: the grow-as-you-go approach to SCSI controllers

START WITH THE BEST ...

DPT's entry level SmartCache Plus board offers unrivaled price/performance for single-user systems. It features ISA or EISA bus mastering, and universal SCSI disk compatibility for all PC operating systems. SmartDriver software supports SCSI-2 peripherals like tape and optical drives.

NOW ADD CACHING!

Get DPT's award-winning caching technology in a plug-in module! Move up to disk caching speed without investing in a new controller. With an integral 512K cache, the module provides up to 5X performance gains for workstations, power users, and small multiuser systems.

ADD MORE USERS, ADD MORE CACHE!

Plug in a 2 MB or 4 MB memory module and accommodate up to 18 users from a single card slot. Ideal for medium-sized networks or multiuser systems.

HOW ABOUT DISK MIRRORING?

DPT's SmartCache mirroring module provides 100% disk fault tolerance by simultaneously writing all data to a second "mirrored" drive. No more data loss or costly system down-time due to disk failures. And unlike software mirroring schemes, fault tolerance is achieved with no performance penalties.

PLUS STILL MORE CACHE, AND THEN SOME...

Cable over to DPT's 4 MB Cache Expansion Card, then grow your system to 16 MB by adding more plug-in memory modules—enough power for 64-plus users!

DPT has your solution—no matter how you grow. Performance, compatibility and upgradability make SmartCache Plus the only SCSI controller you'll ever need. For details, contact Distributed Processing Technology, 140 Candace Drive, Maitland, FL 32751. Phone (407) 830-5522; FAX (407) 260-5366.

See us at PC EXPO, Booth #4081

The logo for Distributed Processing Technology (DPT) features a stylized blue graphic of vertical bars of varying heights to the left of the letters "DPT" in a bold, black, sans-serif font.

Circle 205 on Inquiry Card (RESELLERS: 206).



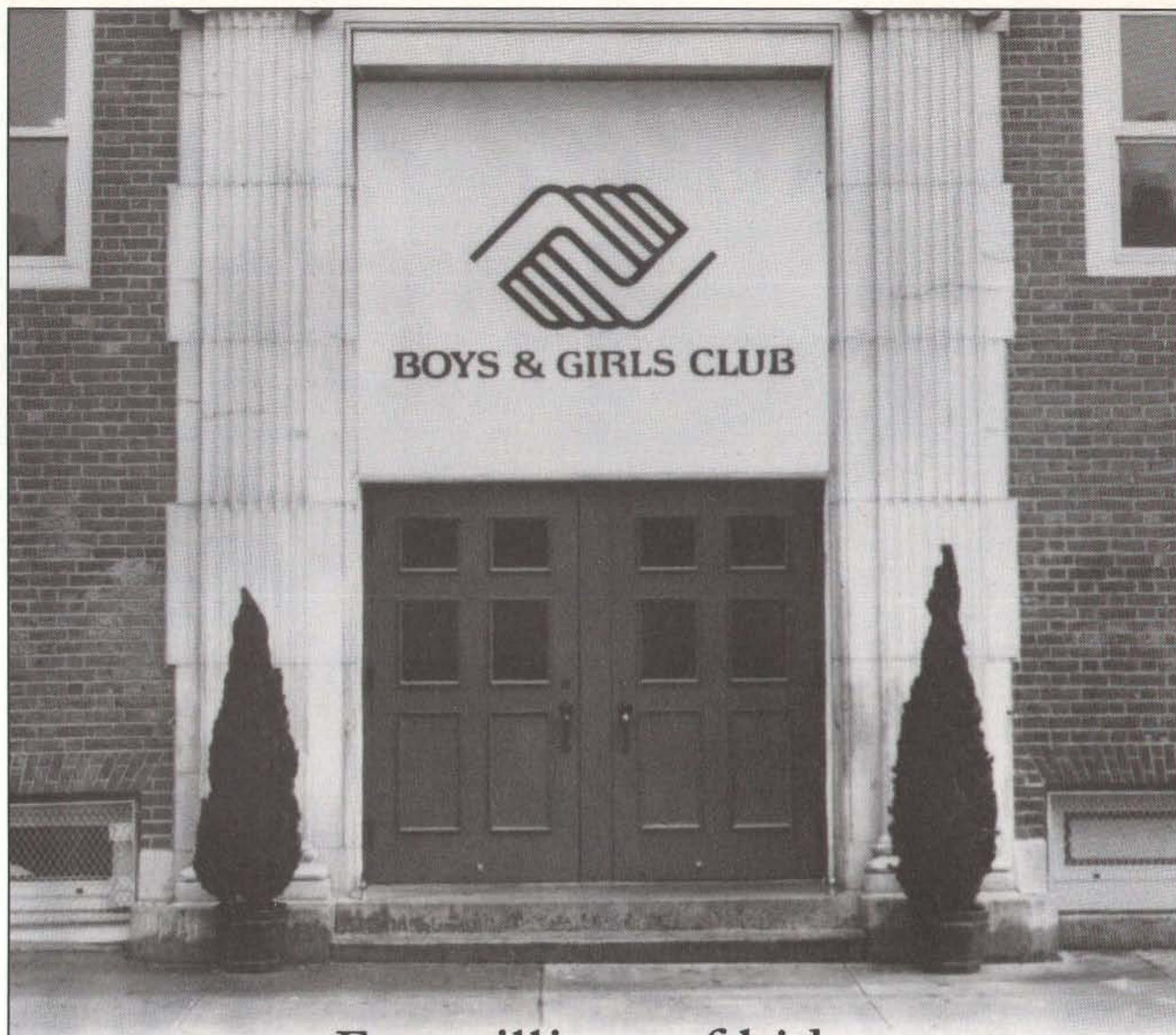

For millions of kids, doors opened when this one did.

When kids walk into a Boys & Girls Club they enter a safe, nurturing environment. One where a trained, professional staff and enriching activities help to instill the knowledge, skills and confidence needed to succeed in life.

Over the years millions of kids have come through our doors. Your contribution helps assure those doors will continue to offer access to opportunity.

Please open your heart and give generously.



BOYS & GIRLS CLUB

SUPPORT THE CLUB THAT BEATS THE STREETS

intersys...The Towering Presence

High Performance 486, 386, and 286 Computer Systems

The Intersys family of computer system embodies an impressive combination of state-of-the-art design, superb engineering and unparalleled value. The result is the flexibility, compatibility and reliability you expect from a leader in the field.

Whether you need a sophisticated high-end 486 or an entry-level 286 system, there's an Intersys out there to suit your needs. Full software compatibility gives you a rich variety of options and ease of network interaction.

Made with pride in the U.S.A., each and every Intersys product is backed by a unique 5-year warranty, as well as outstanding field support, both domestically and internationally.

When you demand superior value, when you want built-in American quality...**think Intersys.**



For more information, or to order call: **(800) 969-COMP**

ISS-1000 The Basic Performer
286/20Mhz, 1Mb RAM,
1.44Mb FDD, 40Mb HDD, 14"
SVGA Mono Monitor
\$845.00

ISS-2000 The Enhanced Performer
386SX/25Mhz, 2Mb RAM, 1.2Mb
& 1.44Mb FDD, 100Mb HDD, 14"
SVGA Color Multisync Monitor
\$1,495.00

ISS-3000 The Optimal Performer
386/40Mhz/64K, 4Mb RAM,
1.2Mb & 1.44Mb FDD, 125Mb
HDD, 14" SVGA Multisync Monitor
\$1,795.00

ISS-4000 The Premier Performer
486SX/20Mhz/64K, 4Mb RAM
1.2Mb & 1.44Mb FDD, 200Mb
HDD, 14" SVGA Multisync Monitor
\$2,295.00

ISS-5000 The Ultimate Performer
486/50Mhz/64K, 8Mb RAM
1.2 Mb & 1.44Mb FDD, 200Mb
HDD, 14" SVGA Multisync Monitor
\$2,495.00

The Intersys Warranty Seal is your assurance of American quality, backed by a unique five-year guarantee!

 intersys inc. 2461 W. 205th St., B103, Torrance, CA 90501, USA TEL: (310) 782-9731, FAX: (310) 782-9815

Circle 212 on Inquiry Card (RESELLERS: 213).

JUNE 1992 • BYTE 395

ALL IN ONE

Fax, Scanner, Printer, Copier

\$595

WHAT-YOU-PRINT-WHAT-YOU-FAX

SEND faxes directly from any Windows application in the same format as if you would print it to LaserJet printer.

RECEIVE faxes as files and print them to your LaserJet printer.

SCAN full page documents, and save them as PCX, TIFF, MSP or DCX files.

COPY documents on plain paper via LaserJet or directly on fax paper.

Or turn off your PC and use ETFA7 as a **STAND-ALONE FAX MACHINE**



COMPEX INTERNATIONAL INC.

312 Broadway Street Cambridge, MA 02139 USA
(617)354-5045, FAX (617)864-9516
AMEX, VISA, MASTER CARD, DINERS

1-800-626-8112

Or call Get-a-Fax at 617-354-1133 from your fax machine, and ask for document # 3011

AMT INTERNATIONAL (COMPUTERS & PERIPHERALS)

3074 LANDESS AVENUE · SAN JOSE, CA 95132
TEL: (408) 942-9695 · FAX: (408) 942-5509



**LOWEST PRICES
SAME DAY SHIPPING**

COMPAQ MEMORY

DeskPro 286-E, 386-20/20E/25	
1MB 113131-001	\$99.00
4MB 113132-001	\$225.00
DeskPro 286N, 386N and 386SX	
2MB 118689-001	\$135.00
4MB 118690-001	\$230.00
DeskPro 388S	
1MB 113646-001	\$99.00
4MB 112534-001	\$220.00
DeskPro 386-33, 486-33 & SystemPro	
2MB 115444-001	\$185.00

AST MEMORY

Bravo-286, Workstation	
512K Kit 500510-010	\$59.00
2MB Kit 500510-002	\$150.00
Premium 386-16/20C	
1MB Kit 500510-007	\$95.00
4MB Kit 500510-008	\$220.00
Premium 386-20	
1MB Kit 500510-003	\$99.00
4MB Kit 500510-004	\$230.00
Bravo-386SX	
4MB Kit 500510-008	\$220.00
Premium 386-SX/25/33 & 486-25	
1MB 500718-002	\$75.00

HEWLETT-PACKARD MEMORY

Vectra QS/16S	
1MB D1540A	\$112.00
4MB D1542A	\$325.00
Vectra QS/20PC, RS/25PC and 20C	
1MB D1640A	\$120.00
4MB D1642A	\$250.00
Vectra 486PC	
1MB D2150A	\$99.00
4MB D2151A	\$390.00

IBM PS/2 MEMORY

Models 30-286, Exp. Board 1497259	
512K Kit 30F5348	\$54.00
2MB Kit 30F5360	\$125.00

Models 70-E61/121, 55SX, 65SX

1MB 6450603	\$85.00
Models 70-E61/121, 50Z, 55SX, 65SX	
2MB 6450604	\$125.00
Models 55SX, 65SX, 34F3077 & 34F3011	
4MB 34F2933	\$210.00

Models 70-A21

2MB 6450608	\$125.00
-------------	----------

Models 80-141

1MB 6450375	\$99.00
-------------	---------

Models 80-111/311

2MB 6450379	\$135.00
-------------	----------

All Models 70 and 80

2-8MB w/2M 6450505	\$275.00
2-14MB w/2M 34F3077	\$350.00
4-16MB w/4M34F3011	\$450.00

Models 50, 90Z, 55SX & 80

2-8MB 1497259	\$599.00
---------------	----------

LASER PRINTER MEMORY

Hewlett-Packard Laser Jet IIP, III & IID	
1MB 334749	\$110.00
2MB 334758	\$150.00
4MB 34477B	\$215.00

Hewlett-Packard Laser Jet IIP & IID

1MB 33443B	\$110.00
2MB 33444B	\$150.00
4MB 33445B	\$215.00

IBM Laser 4019 and 4019e

1MB 1039137	\$175.00
3.5MB 1038675	\$225.00

Canon LBP-811, 811R, 811T

2MB 583-1880	\$199.00
--------------	----------

LAPTOP AND PORTABLE MEMORY

TOSHIBA MEMORY	
1MB Model 1000SE/KE	\$125.00
2MB Model 1000SE/KE	\$180.00
2MB Model T1200XE	\$125.00
2MB Model T1600	\$125.00
2MB Model T3100E	\$125.00
2MB Model T3100SX	\$125.00
4MB Model T3100SX	\$225.00
2MB Model T3200SX	\$125.00
4MB Model T3200SX	\$225.00
2MB Model 5100	\$125.00

2MB Model T5200, T8500

8MB Model T5200, T8500	\$450.00
------------------------	----------

ZENITH MEMORY

1MB SuperSport 286 & 286ES165.00	
2MB SuperSport 286 & 286ES199.00	
2MB SuperSport SX/Alpha	\$199.00

2MB SuperSport SX/Beta

2MB SuperSport SX/Beta	\$199.00
------------------------	----------

COMPAQ MEMORY

1MB Portable LTE 286	\$150.00
2MB Portable LTE 286	\$175.00
1MB SLT-286	\$150.00
4MB SLT-286	\$399.00

NEC MEMORY

1MB Prospeed 286	\$185.00
2MB Prospeed 386	\$250.00

ZENITH MEMORY

Zenith Z-386/20/25/33 & 33E	
1MB ZA36/3800ME	\$99.00
2MB ZA3600MG	\$150.00
4MB ZA3800MK	\$215.00

Zenith Z-386 SX

2MB Z-605-1	\$145.00
-------------	----------

MATH COPROCESSORS

INTEL	
8087-5 MHz	\$70.00
8087-2 8MHz	\$70.00
8087-1 10MHz	\$135.00
80287-6 6MHz	\$79.00
80287-8 8MHz	\$79.00
80287X-8 8MHz	\$89.00
80287XL 8/10MHz	\$89.00
80287XTL 12MHz (Laptop)	\$99.00
80287-10 10MHz	\$89.00
80C287-12 12MHz	\$109.00
80387SX-16	\$129.00
80387SX-20	\$135.00
80387DX-20	\$140.00
80387DX-25	\$185.00
80387DX-33	\$195.00
80487SX-20	\$435.00

WEITEK

3167-20 20MHz	\$300.00
3167-25 25MHz	\$375.00
3167-33 33MHz	\$475.00
4167-25MHz	\$575.00
4167-33MHz	\$700.00

CYRIX

8C87-8	\$59.00
8C287-10	\$75.00
8C287-12	\$85.00
8C287-20	\$85.00
8C387-20	\$155.00
8C387-25	\$158.00
8C387-33	\$175.00

IT

8C87-8	\$69.00
8C287-10	\$79.00
8C287-12	\$89.00
8C287-20	\$99.00
8C387-20	\$175.00
8C387-25	\$175.00
8C387-33	\$200.00

AMD

80C287-10	\$89.00
80C287-12	\$110.00

SIMM MODULES

IBM TYPE	
ADD \$2.00 FOR SIPPS	
4Mx9-80	\$145.00
4Mx9-70	\$145.00
1Mx9-60	\$40.00
1Mx9-10	\$40.00
2Mx9-30	\$40.00
1Mx9-70	\$40.00
256x9-70	\$12.00
256x9-10	\$10.00
256x9-80	\$11.00
256x9-60	\$12.00

APPLE-MAC

1Mx8-70	\$38.00
1Mx8-10	\$37.00
1Mx8-00	\$45.00
4x8-80	\$190.00

DRAM

DRAM IMGX1	
1 MGX1-120NS	\$5.00
1 MGX1-100NX	\$5.25
1 MGX1-80NX	\$5.50
1 MGX1-70NX	\$5.75
1 MGX1-60NX	\$7.50
DRAM 64X1	
4184-150	\$2.00

4184-120

4184-120	\$2.50
4184-100	\$2.75
4184-80	\$3.00

DRAM 64X4

4464-15	\$1.50
4464-12	\$1.99
4464-10	\$2.50

DRAM 256X1

256X1-150NS	\$1.79
256X1-120NS	\$1.99
256X1-100NS	\$2.00
256X1-80NS	\$2.25
256X1-70NS	\$2.35
256X1-60NS	\$3.99

DRAM 256X4

256X4-120NS	\$5.00
256X4-100NS	\$5.50
256X4-80NS	\$5.75

256X1-STATIC COL

51258P-10	\$2.99
AAA 2800-08	\$3.00
AAA 2800-07	\$3.25
AAA 2800-80	\$4.50
1X4-80 ZIPP	\$35.00
1X4-80STT ZIPP	\$39.00
1X4-70STT ZIPP	\$39.00

SYSTEM

486-33 w/ 64k cache	
• 4MB RAM • 1.2 & 1.44 • 130 HD	
• VGA • SVGA 28 Monitor • 101 KB	
• Mini-Tower Case • DOS 5.0	
\$1599	

MONITORS

VGA 41 14"	\$229.00
SVGA 28 14" Int	\$285.00
SVGA 28 14" Non-Int	\$349.00
SVGA 25 14" Non-Int	\$510.00
SVGA 28 17"	\$850.00

MOTHER BOARDS OK

486-33 w/ 256k cache	\$899.00
486-33 w/ 64k cache	\$575.00
486SX	\$425.00
386-33 w/ 64k cache	\$275.00

386-25 Non-cache

386SX-20	\$225.00
	\$185.00

MEMORY BOARDS OK

Boca AT+	\$115.00
Boca XT or 30	\$115.00
Orchid 8/16	\$289.00
Orchid R/16	\$159.00
Rampart	\$95.00
Simply Ram	\$189.00
TI Ram PS/2	\$199.00

1X4 4X1 STATIC

514402-80 (1x4) STT, ZIPP	CALL
514400-80 (1x4) ZIPP	CALL
514400-80 (1x4) DIPP	CALL
514400-80 (1x4) SOJ	CALL
514100-80 (4x1) SOJ	CALL

CASES

Mini-Tower	\$79.00
Mid-Tower	\$95.00
Full-Tower	\$125.00
Desktop	\$95.00

HARD DRIVES

44MB, 28ms, IDE	\$195.00
89MB, 14ms, IDE	\$279.00
130MB, 15ms, IDE	\$339.00
210MB, 15ms, IDE	\$585.00

FLOPPY DRIVES

1.2MB, 5.25"	\$58.00
1.44MB, 3.5"	\$58.00

MODEMS

2400bps Internal	\$49.00
9600bps Internal	\$299.00

FAX/MODEM

9600bps Int S/R Fax	\$85.00
2400bps Modem	\$99.00

APS Technologies

...from the SCSI Drive Specialists

Why Choose SCSI?

5 Good Reasons

- Handles up to 7 devices (& floppy) w/one controller
- Supports CD-ROMs, Tape, DATs, Scanners and more
- Bus Mastering I/O
- Use "Workstation" Quality (and Performance) Peripherals
- Works w/MFM, ST-506, ESDI Drive Controllers and IDE Controllers



Quantum

MB	INTL	EXTL
52	\$239	\$299
105	359	449
120	429	519
240	699	789
425	1149	1249

SyQuest

Model	Bare
SQ-555	\$399
SQ-5110	599
Dual (ext. 44)	899
Dual (ext. 88)	1249

2.6-4^{GB} DAT

APS Archive	\$1699
<i>2.6 - 4 GB Compression DAT</i>	
APS Archive	1499
<i>Desktop and Portable Units</i>	
TEAC 155	599
<i>Above include Sytos Plus</i>	

Maxtor

MB	Intl	Extl
120	\$359	\$439
213	599	699
340	979	1079
535	1349	1449
760	1399	1549

Micronics

386SX	ISA 25	\$259
386DX	ISA 25	399
386DX	ISA/33/Cache	449
486DX	ISA/33/Cache	859
486DX	EISA/33/Cache	1199
486DX	ISA/50/Cache	1449

Toshiba

CD ROM	
3301B	\$579

*We Recommend
Adaptec® Controllers!*

SCSI Kits available ONLY w/Drive Purchase

Please Call for Prices

Some Kits may not be available with all models

- **30-Day Money-Back Guarantee** • All products carry a 30-day money-back guarantee. Your risk in the transaction is the cost of shipping.
- **Disk-for-Disk Replacement Warranty** • Quantum, Maxtor, Syquest and Archive drives carry a two-year "parts & labor" disk-for-disk replacement warranty. WREN, Teac, WangDAT, Micronics products and Syquest Cartridges carry a one-year "parts & labor" disk-for-disk (board-for-board) replacement warranty.

- **Mounting Hardware & Cables Included** • All Hard Drives include rails, extenders and data cables required for standard operation. Board products are populated but without RAM.
- **Toll-Free Technical Support** • Toll-Free Technical Support, 9am to 7pm Monday thru Friday, Central Standard Time. As often or for as long as you need.
- **Prices & Specifications Subject to Change Without Notice** •



M-F 7AM—9PM CST SAT 10AM—4PM CST

Visa/MC, Discover No Surcharge AMEX Accepted

International: 1-816 478-8300 FAX: 1-816 478-4596 (24 Hrs) Toll Free UK: 0800-897-545 Toll Free Australia: 0014-800-125-875

Alliance Peripheral Systems, 2900 S. 291 Hwy., Independence, MO 64057

1-800 235-3707

Get the latest technology. Anything else is obsolete. CALL:

1-800-UP-I-JUMP

and Jump up to a 14,400 baud Data Modem/14,400 baud Fax Modem!

Automatically falls back for slower fax machines or slower modems, but when you connect to a fast one, you fly!

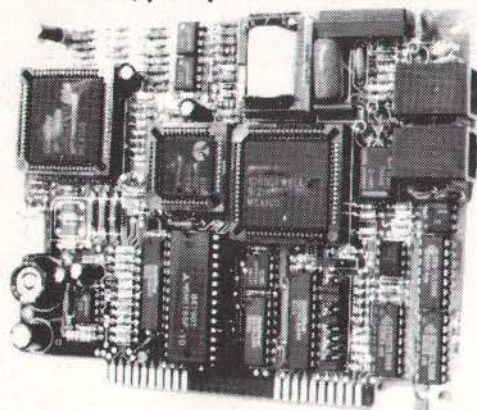

*Half-card,
installs in
any open
slot!*

You'll pay for the jump up in speed with the savings from just a few long distance phone bills using a 2400, 4800, or even 9600 baud modem.

No Risk - Satisfaction Guaranteed

\$399 14.4/14.4
Data/Fax Modem

- YES 14,400 V.17 Fax, V.32 BIS/V.42 BIS 57,600 bbs throughput modem
- YES CAS implementation - full network, windows 3.0 etc., compatibility
- YES Background send & receive
- YES Uses single COM port (1-4)
- YES Automatically falls back through 5 baud rates
- YES MNP 2 - 4 & 5 data compression & error correction
- YES To and from any group 3 fax or any dial up modems
- YES Super software included - FAX & modem in one program
- YES Five year warranty
- YES Every board fully tested in actual use before shipping
- YES Reliable error-free connectivity

Business Instruments
Computer innovations Since 1978
Order 1-800-UP-I-JUMP

AMEX, MC, VISA, Company Check, COD
Tech (214) 980-9990
FAX (214) 980-7030
13410 Preston Rd., Dallas, TX 75240



Computex
booth no. B226-232

ARTEC PRODUCT LINE

- Flat-bed Color Scanner A4000C
- Handy Color Scanner A256S, A1000C
- Handy B/W OCR Scanner A400Z, A400NB
- Serial Mouse AM22S, AM24S, AM25, AM28, AM30
- Bus Mouse: ATARI, COMMODORE/
AMIGA, NEC/EPSON, MICROSOFT
Mouse Compatible AM29
- PS/2 Mouse AM27, AM30

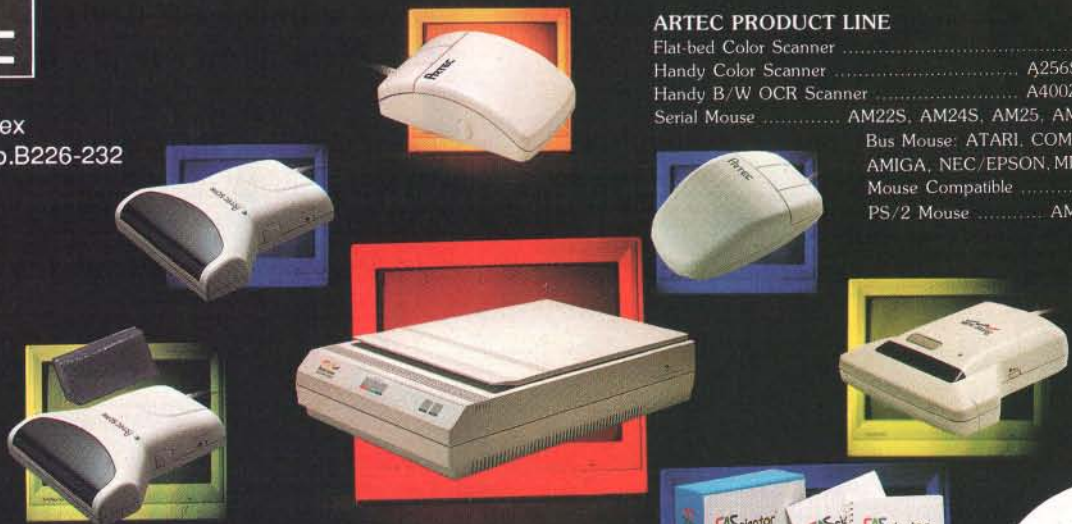

ARTEC treasures your creations

ARTEC SCANNER can offer to project the best image from paper into your PC.

New! ARTEC SCANNER A400NB

for Notebook computer now you may scan text or graphic file anytime and everywhere.



ULTIMA ELECTRONICS CORP.

MAIN OFFICE
9F, NO. 18, ALLEY 1, LANE 768, SEC. 4, PA TE ROAD,
TAIPEI, TAIWAN, R.O.C. TEL: 886-2-7885470 (REP.)
FAX: 886-2-7885657, 7885655
USA BRANCH
1156 ASTER AVENUE, SUITE A, SUNNYVALE,
CA 94087, U.S.A.
TEL: 408-246-9208 FAX: 408-246-9207

Circle 223 on Inquiry Card (RESELLERS: 224).

DENMARK
UNIPRO A/S
TEL: 4586286366 FAX: 4586286870
HOLLAND
SOECOMA COMPUTERS NED BV
TEL: 31-40-533515 FAX: 31-40-544535

HUNGARY
HUMANSOFT ELECTRONICS LTD.
TEL: 361-1833930 FAX: 361-18311789

CZECHOSLOVAK
COVER s.r.l.
TEL: 0444/491000 FAX: 0444/491010

GERMANY
ELITO ELECTRONIC GMBH
TEL: 09241/5065 FAX: 09241/1508
R+P SUPERWAVE ELECTRONIC GMBH M.
TEL: 030-788-040 FAX: 030-786-4147
TLX: 18419 BURYA
R+P COMPUTER GMBH QUERSTUCKEN
TEL: 040-524-50-38 FAX: 040-524-29-01

Although We Carry A Variety Of Products, We Only Offer Quality.

No matter what you buy from us, you won't have to worry. Because at Universal, we only stock the most reliable products in the industry.

That's why, we can offer a 5 year warranty with a 30 day, money back guarantee on every product.

Plus, everything you buy is guaranteed to be compatible with your computer. Because when you call to order, our sales service department will help you figure out exactly what you need. They're knowledgeable about every product. So they'll be there for you every step of the way.

And just to make sure nothing is overlooked, we also check every product for quality before it's shipped. After that, it's sent to you anyway you like.

So if you want to upgrade your computer, use Universal. Because everyone who orders a product from us, gets the same thing.



EXPANSION BOARDS

Orchid Technology

Ramquest 16/32
OK \$229 2MB \$329
2-8MB for PS/2 50/55/60/70/80
Ramquest 8/16 OK \$149 2MB \$245

BOCA Research

Bocaram At Plus
OK \$119 2MB \$199 2-8MB LIM 4.0 AT's
Bocaram 2 for PS/2's OK \$159 2MB \$219
Bocaram XT-PS/2 30 1MB \$159

AST Research

Rampage Plus 286 OK \$189 2MB \$289
up to 8MB for AT UM 4.0
Fastram 286 1MB \$279
Cupid 32 OK \$250

VIDEO GRAPHICS CARDS

ATI

8514 Ultra 1MB PS/2 or ISA BUS \$449
Graphics Ultra 1MB & mouse \$549
Graphics Vantage w/1MB \$389
NEW!!! VGA Stereo XL w/1MB \$375
VGA Wonder XL 1MB w/mouse \$239

Orchid Technology

Fahrenheit 1280 w/1MB & Sierra \$379
Prodesigner IIS 512K \$199 1MB \$219
Prodesigner IIMC for PS/2 1MB \$399

BOCA Research

BOCA Super VGA 512K \$139 1MB \$179

PRINTER UPGRADES

Hewlett Packard

Laserjet IIP, III, IIID, IIIP
1MB \$69 2MB \$119 4MB \$199
Laserjet II, IID
1MB \$89 2MB \$119 4MB \$199

Panasonic 4420 & 4450I

1MB \$109 2MB \$129 4MB \$229
4450 1MB \$179 4455 2MB \$269

Epson EPL 6000 & EPL 7000

1MB \$129 2MB \$145 4MB \$235

IBM 4019 & 4019E

1MB \$115 2MB \$139 3.5MB \$199

OKI 400, 800, 820, 830, 840

1MB \$119 2MB \$169 4MB \$199

Canon

LBP 4 2MB \$209 LBP 8 2MB \$119

MEMORY CHIPS & MODULES

DRAM

1X1-70NS \$4.95 256X4-80NS \$4.99
1X1-80NS \$4.50 256X4-100NS \$4.95
256X1-80NS \$1.99 256X1-120NS \$1.75
256X1-100NS \$1.85 256X1-150NS \$1.50
64X4-80NS \$3.00 64X1-100NS \$1.75
64X4-100NS \$2.75 64X1-120NS \$1.60

SIMM/SIPP Modules

4X9-70NS \$169 4X9-80NS \$159
1X9-70NS \$42 1X9-80 \$41
1X9-100NS \$40

MATH CO-PROCESSORS

IIT

US83C87-16, -25, -20 & -33 \$169
US83C87-16SX \$115 -20SX \$129
New US83C87-40 \$199

Intel

80387-16, -20, -25 & -33 \$239
80387-16SX \$139 -20SX \$189
80287-10 \$75 80287XL \$90

IBM PS/2 UPGRADES

IBM PS/2 Memory

6450604 2MB MOD 50Z, 55SX, 70 \$99
6450608 2MB MOD 70A21 \$119
34F2933 & 77 4MB PS/2 SIMM \$199
6450129 8MB SIMM \$564
30P5360 2MB for 30-286 \$99
6450128 4MB MOD 90 & 95 \$219
6450902 2MB MOD 90 & 95 \$129
6450609 2-8MB MOD 50, 50Z, 60 \$298
6450605 2-8MB MOD 70 & 80 \$350
34F3077 2-14MB MOD 70 & 80
w/2MB \$298
34F3011 4-16MB MOD 70 & 80
w/4MB \$429

PS/2 Hard Drives

Zero Slot for 50, 50Z
52MB \$395 80MB \$495 105MB \$599
124MB for 55SX, 70 \$740 240MB \$999
200MB \$1065
124MB MDL 55SX, 70 \$740 200MB \$1065

Processor Upgrades by Kingston

IBM PS/2 50, 60, 50Z, 30/286, 25/286,
AT, XT/286, AST Premium/Bravo 286,
Compaq Deskpro 286, Portable III, HP
Vectra ES/12, ES/8, NEC PowerMate
286+, Portable +, Epson 286: 20MHZ for
\$341 25MHZ for \$419

COMPAQ UPGRADES

Compaq Deskpro

Deskpro 386/20, 25, 20E, 25E & 386S
4MB Module \$229 4MB expboard \$327
Deskpro 386/33 486/25 Systempro
2MB Module \$149 6 socket exp. brd.
w/2MB \$395

1/3 height floppy disk drives

1.44MB \$129 1.2MB \$139

Portables

LITE 286 1MB \$99 2MB \$169 4MB \$449
LITE 386S/20 1MB \$209 4MB \$399
386/20 1MB Upgrade kit \$145
4MB exp/ext brd \$375
SLT 286 1MB \$119 4MB \$429
SLT 386 1MB \$129 2MB \$255
4MB \$435

LAPTOP UPGRADES

Toshiba

T1200XE/SE, T1600, T3100E, T3100SX,
T3200SX, T5100, T5200, 2MB \$112
T3200SXC 2MB \$159 4MB \$329
T1000SE/XE/LE & T2000SX 1MB \$119
2MB \$229
T1000LE & T2000SX 4MB \$419
T3100SX, T3200SX 4MB \$229
T3200 3MB \$254

Megahertz Laptop Modems

2400 BD internal \$149 w/MNP5 \$210
2400/9600 FAX/Modem w/MNP5 \$319

NEC UPGRADES

Powermate SX 2MB \$395 4MB \$575
Powermate SX Plus 2MB \$299 4MB \$525
Powermate SX/20
2MB CPU \$189
2MB EXP \$235
Powermate 386/
20/25 2MB \$325
8MB \$799

ZENITH UPGRADES

Z-386/20/25/33
and 33E 1MB \$64
4 MB \$219

MastersPort SL

386SX 2MB \$199

SlimsPort/

SuperSport, SX,
286E \$159

TurboSport 386,

386E 1MB \$149
4MB \$495

Same day shipping by UPS, Federal Express or DHL. Order worldwide by PO, C.O.D., APO, FPO & credit card with no surcharge added. 20% restocking fee on all non-defective returns.

UNIVERSAL MEMORY PRODUCTS 15451 Redhill, Suite E,
Tustin, CA 92680 ☐ Phone: 714/258-2018 Fax: 714/258-2818
Hours M - F 6:30 - 5:00 SAT 8:00 - 2:00 PST



800/899-8518

UNIVERSAL
MEMORY PRODUCTS

RIGHTON® COMPUTER SECURITY

AFFORDABLE • EFFECTIVE • MOBILE

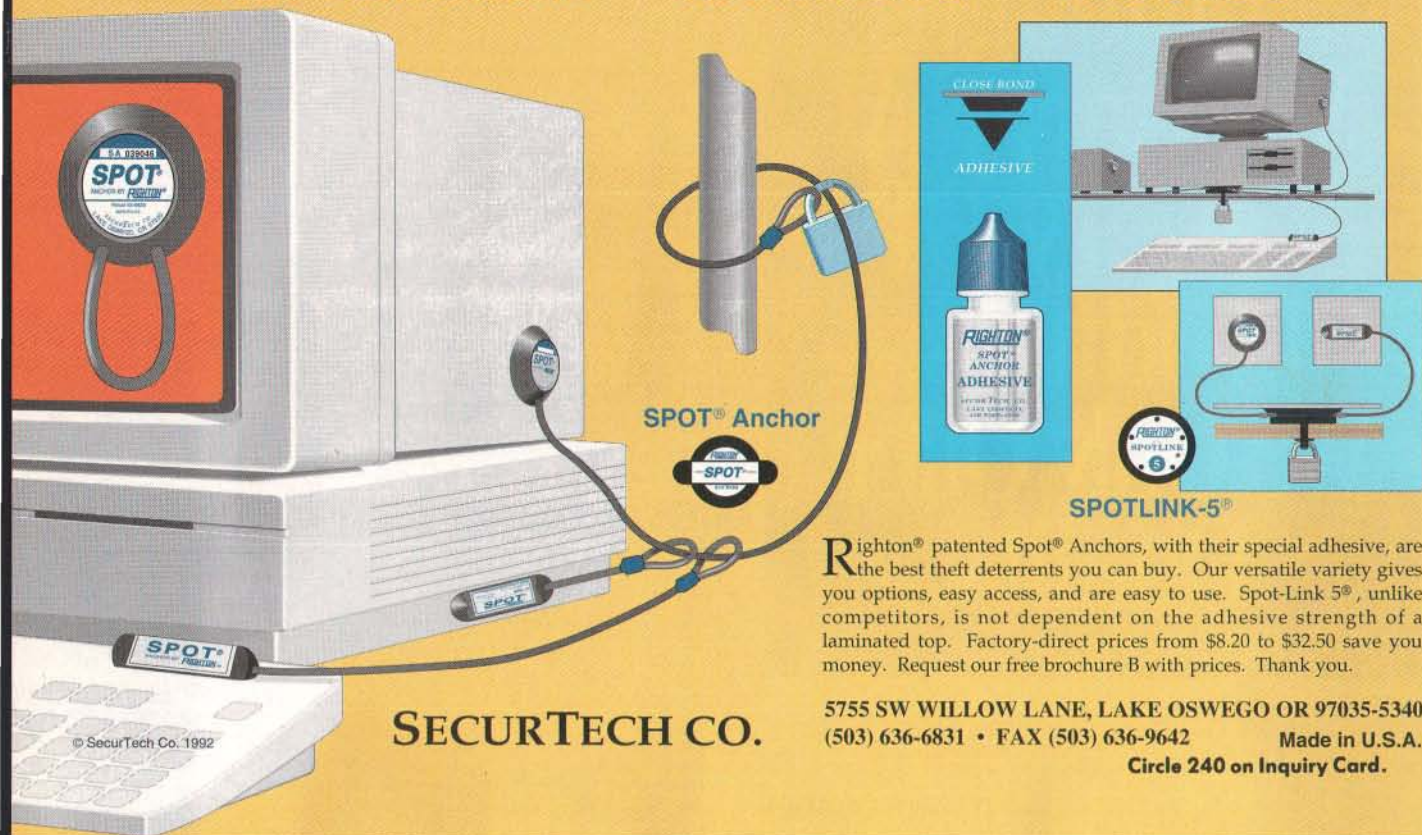

SPOT Anchor

SPOTLINK-5®

RIGHTON® SPOT-ANCHORE ADHESIVE

RIGHTON® SPOTLINK-5

© SecurTech Co. 1992

SECURTECH CO.

Righton® patented Spot® Anchors, with their special adhesive, are the best theft deterrents you can buy. Our versatile variety gives you options, easy access, and are easy to use. Spot-Link 5®, unlike competitors, is not dependent on the adhesive strength of a laminated top. Factory-direct prices from \$8.20 to \$32.50 save you money. Request our free brochure B with prices. Thank you.

5755 SW WILLOW LANE, LAKE OSWEGO OR 97035-5340
(503) 636-6831 • FAX (503) 636-9642 Made in U.S.A.
Circle 240 on Inquiry Card.

❖ ADVERTISERS ❖

Run a full- or half-page 4-color ad
reaching a portion of **BYTE's U.S.** readers
at unbelievably low rates — right here in this section!

Call today to learn more about **BYTE's** unique *Regional Advertising Section*, located in our prominent *Buyer's Guide*.



(603) 924-2651 or (603) 924-2637

The Cream.

The Crop.



There are plenty of places to get information in this industry. Too many. But if you want the best quality information, there's only one that rises to the top: **BYTEWEEK**.

BYTEWEEK is a weekly newsletter from the same professionals who produce **BYTE Magazine**. Each week, the most important news and information from the previous week is presented in a readable and concise manner. **BYTEWEEK** offers you what no other publication can: timely news on the rapidly-evolving computer industry as it happens with the interpretation and evaluation that only **BYTE's** experienced editorial staff can provide.

Subscribe now and take advantage of a special subscription rate of \$395 (\$495 outside the U.S. and Canada). *Don't miss this opportunity!*

For fastest service, call toll-free 1-800-258-5485 (in N.H., call 603-924-9281) and charge to a major credit card or we'll bill you.

BYTEWEEK

One Phoenix Mill Lane, Peterborough, NH 03458.

BYTEWEEK offers a money-back guarantee if you are not completely satisfied.

Clip Coupon Here



YES! Sign me up as a subscriber to the Cream of the Crop, **BYTEWEEK** at the special subscription rate of \$395 a year for 50 issues (\$495 a year outside the U.S. and Canada).

Name _____
 Title _____
 Company _____
 Mail Address _____
 City/State/Zip _____
 Business Phone _____

MasterCard VISA
 Check enclosed Bill me

Card # _____
 Exp. _____
 Signature _____

BYTEWEEK 

One Phoenix Mill Lane
 Peterborough, NH 03458

Circle 334 on Inquiry Card.

JUNE 1992 • BYTE 401

Add-In Boards

Industrial PCs and Data Acquisition



- Industrial Workstation and Monitor
- Industrial Computer Chassis
- All-in-one Plug-in CPU Card
- RAM/ROM Disk Card
- Data Acquisition & Control Series
- Industrial I/O Series
- IEEE-488 Interface Card
- 8/16 Port RS232 Interface Card
- Application Software Package



AXIOM TECHNOLOGY CO., LTD.
20418 East Walnut Drive Unit H Walnut, CA 91789, U.S.A.
TEL: 714-598-9495 FAX: 714-598-9975

Circle 292 (RESELLERS: 293) on Inquiry Card.

Add-In Boards

ROMDISK™
New PCE/2-SR SRAM Emulator

Disk and Drive Emulators



- Multiple models, EPROM, Flash, battery backed SRAM technologies
- Capacities from 180K to 14MB, Single and Dual disk emulation under MS DOS
- Autobooting—on-board programming

418 West County Road D
St. Paul, MN 55112

CURTIS, INC.
MS DOS is a trademark of Microsoft

612/631-9512
FAX 612/631-9508

Circle 250 on Inquiry Card.

486 SINGLE BOARD COMPUTER CARDS

- BSBC486 including:
- Up to 32 MB DRAM on board
 - INTEL 486DX or SX support
 - IDE hard disk interface
 - Floppy controller
 - 2 serial ports
 - 1 parallel port
 - Keyboard port, clock
 - Optional thermal sensor
 - UNIX and DOS verified
 - Available 64 MB option
 - AT form factor
 - 2-year warranty

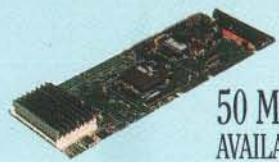

50 MHz AVAILABLE

- Also available:
- Workstation computer card (486 CPU, 32 MB DRAM, IDE, Floppy, 2S/1P, VGA, Ethernet)
 - EISA AND ISA passive backplanes
 - 8 and 10 slots, back to back (8-slot only) and standard

Other products available. CALL US!

Qty 2: \$595 ea.
(CPU and memory not included)



4780, Henri-Bourassa Blvd.
Charlesbourg, Qc. Canada G1H 3A7
(418) 622-6777 Fax: (418) 622-9996

Circle 247 on Inquiry Card.

PMP MEMORY UPGRADES
MEMORY EXPANSION BOARDS

16 Bit ISA/AT	2M/\$180	4M/\$260	8M/\$410
16 Bit MCA (PS/2 50 - 65SX)	2M/\$220	4M/\$300	8M/\$469
32 Bit MCA (PS/2 70 - 95)	2M/\$299	4M/\$450	8M/\$700
MEMORY MODULES		LASER PRINTER MEMORY	
PS/2 32 Bit SIMMS			
1M/\$59 • 2M/\$99 • 4M/\$189 • 8M/\$399	HP2P, 2D, III, IIP • 1M/\$89 • 2M/\$119 • 4M/\$195		
1Mx9 SIMM • 3 CHIP • 80ns/\$39	Panasonic 4420 • 1M/\$99 • 2M/\$139 • 4M/\$195		
60 ns/\$50 • 70ns/\$45 • 80ns/\$41	IBM4019, 4019E • 1M/\$89 • 2M/\$135 • 4M/\$189		
1Mx9 SIMM	EPL 6000 • 2M/\$149 • 4M/\$229		
60 ns/\$50 • 70ns/\$45 • 80ns/\$41	Toshiba Page Laser 6 • 2M/\$149 • 4M/\$229		
4Mx9 SIMM	Packard Bell • 2M/\$149 • 4M/\$229		
60 ns/\$199 • 70ns/\$159 • 80ns/\$149	Canon LBP4 • 1M/\$179 • 2M/\$239		

Call Us For ALL Your Memory And Hard Drive Needs

PMP PHOENIX
1438 Scottsdale Rd. • Tempe, AZ 85281
FAX (602) 994-0776
1-800-424-1968

PMP SAN DIEGO
1565 Creek Street • San Marcos, CA 92069
FAX (619) 471-9591
1-800-255-8607



Circle 298 on Inquiry Card.

TALK TO YOUR COMPUTER

WITH VOICE MASTER KEY® SYSTEM II

AN ALL-EXTERNAL PROFESSIONAL VOICE PROCESSING SYSTEM...
FOR ALL IBM PC/COMPATIBLES, PS/2, NOTEBOOKS, OR LAPTOPS

ADD UP TO 1024 VOICE COMMANDS TO EXISTING PROGRAMS! Speeds data entry and command input to CAD, desk-top publishing, word processing, spread sheet, data base, or game programs. Simply train the computer to recognize a word or phrase and assign a series of key strokes to that command. Pop-up TSR program features pull-down menus and mouse support. Requires under 15K of main memory if EMS present. Near instant response time and high recognition accuracy.



SOUND RECORDING STUDIO
Digitally record your own speech, sound, or music. Software controlled sampling rate (up to 25Kbytes/sec) with graphics-based editing and data compression utilities. Create customized audio software for use within education, language training, presentations, entertainment, etc.

INTERACTIVE SPEECH INPUT AND OUTPUT
Tag your own digitized audio files to voice recognition macros. Provides speech response to your spoken commands -- all from within virtually ALL DOS application software! Reduces CRT "eye fixation". Also ideal for training, security, robotics, factory-business-home automation, science experiments, handicapped, etc.

COMPATIBLE with talking software from IBM, Milliken, First Byte, Davidson, Optimum Resources, Britannica Software, Electronic Arts, Hyperglot, Orange Cherry, Wesson Int'l, Villa Crespo, McGraw-Hill, etc. -- both DOS and Windows-compatible versions.

EVERYTHING INCLUDED. Hardware enclosed in a sturdy vinyl-clad steel box with built-in speaker with separate tone/volume controls, external speaker and headphone jack ports, and external line-level inputs and outputs. (No card slots required.) Additional accessories include a durable lightweight microphone headset, 6-foot parallel port cable, 9 volt AC adapter, software (both 5.25" and 3.5" formats), and manual. Made in U.S.A. One year warranty on hardware.

ONLY \$239.95 (plus shipping)

ORDER HOTLINE call: (503) 342-1271 Monday-Friday 8 AM to 5 PM Pacific Time. VISA/MasterCard/American Express phone or FAX orders welcome. NO CODs. Add \$5 shipping charge for delivery in USA and Canada. Payment by personal check subject to 3 week shipping delay. Foreign inquiries contact Covox for C&F/CIF proformas.

30 DAY MONEY BACK GUARANTEE IF NOT COMPLETELY SATISFIED.

CALL, WRITE, or FAX US FOR FREE PRODUCT CATALOG



COVOX INC.
675 Conger Street
Eugene, Oregon 97402 U.S.A.

Tel: (503) 342-1271
FAX: (503) 342-1283
BBS: (503) 342-4135

Circle 248 (RESELLERS: 249) on Inquiry Card.

Direct Stepper Drive from PC



- Direct drive
- High speed up to 25,000 s/s
- Power supply fits in PC drive bay
- FREE HPGL interpreter
- 2D and 3D linear and circular interpolation

Call (613) 359-1029 Fax (613) 359-1147



P.O. Box 188, Elgin, Ontario, Canada K0G 1E0

From **\$199**
Qty 1

Circle 270 on Inquiry Card.

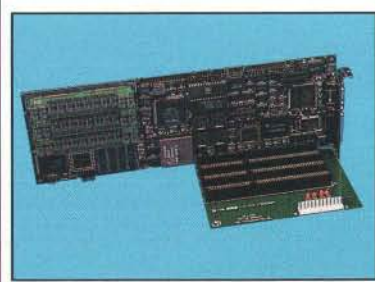

VMAX® 386DX COMPLETE COMPUTER

- FAST 80386 DX 40Mhz processor
- COMPACT size, AT Bus or stand alone
- 100% DOS Compatible, AMI BIOS
- CONTROL SVGA, IDE, FDC, 2Ser, Bi-Par
- SOLID STATE DISK 2 drives to 1.5 Meg
- SOFTWARE included for SSD, EMM, VGA
- CACHE to 128K. DRAM to 48M
- Made in USA, 1 Yr. Warr.
- \$1195 Qty. 1 OK

Fax for fast response! **TEMPUSTECH, INC.**

TEL: (800) 634-0701 295 Airport Road
FAX: (813) 643-4981 Naples, FL 33942

Circle 288 on Inquiry Card.

For Your Communication Needs!



PCSS-81 INTELLIGENT SERIAL COPROCESSOR

- On board processor handles serial communication tasks.
- 32K-128K Dynamemory.
- Eight ports per board.
- High performance — Low cost!
- DOS, SCO XENIX, SCO UNIX drivers included.

OEM & Dealer Inquiries Welcomed!

GTEK INC.

DEVELOPMENT HARDWARE & SOFTWARE
P.O. Box 2310 • Bay St. Louis, MS 39521-2310 U.S.A.
Order Toll-Free 1-800-282-4835 • Fax: 601-467-0935
Mississippi & Technical Support 601-467-8048

Circle 255 on Inquiry Card.

AT Systems in ROM

Single Board Computers

- Run DOS from ROM
- PC code compatible
- Large memory space
- Passive backplanes



Develop code on a PC. Use standard PC cards for expansion. Burn your code and DOS into ROM and run on our CPU cards.

KS6 CPU: NEC V53 uP(286eq). 5 serial, 2 Parallel, Clock, AT bus Max of 4M Ram, 2M Rom, 512K battery backed Sram. \$349-q1 oem

KS3 CPU: V40 uP. 3 Serial, 2 Par., Clock, Flop, Keybd. \$249-q1.

303-444-7737

Fax 303-786-9983 655 Hawthorn Ave., Boulder CO 80304

KILA

Circle 259 on Inquiry Card.

THE BEST NAME IN IEEE-488 INTERCONNECT PRODUCTS

L-com is your ONLY complete source for creative IEEE-488 wiring solutions.

L-com has not one, but seven IEEE-488 cable series. Includes all molded, aluminum shells, and in-line types for easy entry into PC ports.

L-com is the only provider of a full series of IEEE-488 adaptors. More than twenty varieties in all, such as slimline, bulkhead, reversers, & right angle. Many other accessory items also!

Call or Fax today for further information.

L-com Inc. TEL: 508-682-6936 FAX: 508-685-6467



Call for FREE catalog! Specify - BYTE

Circle 289 on Inquiry Card.

LOW-LOW-LOW

Computer Systems / Notebook / Complete Network Solutions

IBM Apple COMPAG AST ALR EVEREX and others

SURAH 386/486 ISA/EISA Compatible Computers

AMI/Mylex Motherboards
IOmega Bernoulli Drives
CD ROMS Tape Backup
Mini-SCSI • Parallel to SCSI
Host Adapter
Trantor Systems

LAN Cards/other products
3COM, Novell, Antherm, Gateway, Proteon & others
Hard Drives/Floppy Drives
IDE (Netware Ready)/SCSI
Also available for IBM, Compaq, Apple
Memory/Upgrades
DRAMs, SIMM Modules
Math coprocessors
Laser Printers/Scanners
Plotters/Digitizers/Software

44912 Osgood Road, Fremont CA 94539 USA
Phone: (510) 651-5101 Fax: (510) 651-5241
1-800-543-1001 Nationwide Orders
UK Fax: 081-855-9657

SURAH inc.

Circle 271 on Inquiry Card.

Best Value

Voice/Fax/Modem On A Single Card

TeleLink Turns Your PC Into A Personal Communication Center



- Both DOS and Windows software available
- Background operation capability
- Full answering machine functions
- Auto message forwarding
- Phonebook management with auto-dialing
- Precision scheduling/telemarketing
- 9600 background send/receive FAX
- 2400 Hayes compatible Modem
- Laser quality faxes with PCL4 language
- Direct fax from Wordperfect/Lotus
- One-year warranty

Distributors are welcome!

TeleLink TeleLink Tech. Corp. P.O. Box 497, Addison, IL 60101
Tel: 708-832-7527 Fax: 708-832-7571

Circle 296 (RESELLERS: 297) on Inquiry Card.

50 MHZ 80486 ISA/EISA 23 MIPS
Faster than Compaq & Dell



EISA/ISA BABY SIZE MADE IN USA

ISA SYSTEM BOARD					EISA UPGRADABLE BOARD				
MODEL	CACHE	MIPS	OK Board	Base System	MODEL	CACHE	MIPS	OK Board	Base System
486DX/50	64K	23.0	1150	1350	486DX/50	256K	23.0	1599	1799
486DX/2/50	64K	23.0	945	1145	486DX/2/50	2564K	23.0	1399	1599
486DX/33	64K	15.0	745	945	486DX/33	256K	15.0	1199	1399
486SX/20	64K	9.0	480	680					
386DX/40	64K	10.8	340	540					
386DX/33	64K	8.3	330	530					

All bare systems include a baby desktop, IDE 2s/1p, 101-keyboard, 200 Watt power supply. Tower system with 250 Watt power supply add \$150. FCC Class B, UL, TUV are available.

FEATURES

- 64/256K Write Back Cache
- Burst Mode Design
- Shadow RAM on Video & BIOS
- 64MB 32 Bit Memory Expansion
- Baby-size with Eight Expansion Slots
- 100% UNIX, OS/2 & Novell Compatible
- One Year Full Warranty
- Made in USA

386SX with IDE/2s/1p

MODEL	BOARD	Base System
386SX/33	210	410
386SX/25	199	399
386SX/20	185	385

TECHNOLOGY POWER ENT., INC.
47273 Fremont Blvd., Fremont, CA 94538
Tel: 510-623-3818 FAX: 510-623-3840

All names mentioned above are trademarks of their respective companies. Prices are subject to change without notice.

Circle 272 on Inquiry Card.

MYLEX Call EXALINX TODAY for: 1st QUALITY

MAE 486-50/33 EISA 128k - up to 32Mb
MDI 486-50/33 ISA 64k - Imbedded I/O
DCE-376 SCSI Controller 32-Bit - 80387 - 2-Floppy
GXE-020 Graphics Processor 1280x1024 - TIGA - 2/4Mb
LNE-390 SCSI Network Card 32-Bit - Novell/SCO Certified

MYLEX EISA KIT SPECIAL MAE 486-33 w/128k - up to 32Mb
DCE 376 EISA SCSI Controller LNE 390 EtherNet Card FOR ONLY \$ 2250
MYLEX ISA KIT SPECIAL MDI 486-33 w/64k
GLI 911 ISA 16-bit Graphics S/Chip IN2000 SCSI Controller FOR ONLY \$ 1449

We Accept MasterCard & VISA 2nd-year Warranties Available

EXALINX inc. SALES INQUIRIES AND ORDERS
COMPUTER HARDWARE **800/992-5469**

PO Box 454 Beautiful Buffalo, NY USA 14209 - Support: 716/882-0791 - Fax: 882-9650
Corporate & Government P.O.'s Welcome We Stock Memory & CHICONY K/Boards

The Difference IS Dedication to Excellence!

Circle 303 on Inquiry Card.

Computer Systems

Rackmount Solutions

- RACKMOUNT COMPONENTS - Qty 25 PRICING
- Rackmount Chassis 19"x7"x17" \$183
 - Rackmount VGA Monitors \$531
 - Rackmount Monitor Shelf \$113
 - Rackmount Keyboard Shelf \$88

- RACKMOUNT PLATFORMS - Qty 1 Pricing
- RMS286-12 \$549 RMS386-33 \$1095
 - RMS386SX-16 \$795 RMS486-33 \$1695
- System Platforms include 7" Rackmount Chassis, 200W Power Supply, Motherboard, 1.0MB Memory, IDE, FDC, 2-Ser, Par, 1.2MB or 1.44MB Floppy Disk Drive, 1 Year Warranty

- RACKMOUNT CHASSIS - 15 Models up to 20 Board Slots
 SLOT CPU BOARDS - 486, 386, 386SX, 286
 RACKMOUNT MONITORS - Super VGA and Monochrome
 RACKMOUNT CABINET - Modular from 21" to 96" high



2468 Armstrong Street
 Livermore CA 94550
 (510) 447-2030 FAX: (510) 447-4559

Circle 282 on Inquiry Card.

Data Acquisition

NEW, FREE 288 PAGE DATA ACQUISITION & CONTROL CATALOG/REFERENCE GUIDE FOR IBM PC/XT/AT, PS2, MICROCHANNEL COMPUTERS AND COMPATIBLES.



NEW 1992 CATALOG

- * A/D BOARDS
- * SIGNAL CONDITIONING
- * COMMUNICATION
- * INDUSTRIAL CONTROL
- * PC INSTRUMENTS
- * SCIENTIFIC SOFTWARE

SEND TODAY FOR YOUR FREE 288 PAGE KEITHLEY METRABYTE CATALOG
 440 Myles Standish Blvd., Taunton, MA 02780 Tel:(508)880-3000 TLX:503989 Fax:(508)880-0179

Circle 262 on Inquiry Card.

EMBEDDED COMPUTERS

If you would like to....

- Use powerful 3-MIPS 16-bit processing
- Drive graphics LCDs and keyboard
- Collect 10-bit analog data from 8 channels
- Store information on PCMCIA Cards
- Interface with a PC or modem
- Perform multitask operations
- Buy at competitive prices



...then the TDS2020 Series is for you



For more information contact:
The Saelig Company Tel (716) 425-3753 Fax (716) 425-3835
 Outside USA & Canada: **Triangle Digital Services Limited**
 223 Lea Bridge Road, London Tel 081-539 0285 Fax 081-558 8110

Circle 274 on Inquiry Card.

The Intelligent Solution For Data Acquisition



DAP 2400™ Data Acquisition Processor™

- ANALOG I/O
- DIGITAL I/O
- Inputs to 235K samples per second
- Outputs to 250K samples per second
- FFT and FIR-filtering
- Digital Signal Processing at 10 MIPS
- 16 MHz CPU with DRAM to 512K
- 20 MHz DSP with SRAM to 96K
- DAPL™ Operating System
- 100+ standard commands
- Custom commands in C



Send for FREE catalog.
 Or call us at (206) 453-2345

Circle 264 on Inquiry Card.

EYE POPPING!

Renegade Raises the Ceiling on 486/50 MHz Speed and Power at Huge Savings.

This is the machine with every feature you've read about and wanted: Intel 80486 processor, 128K cache RAM, 8 Mb RAM, 1.2 Mb and 1.44 Mb floppy drives, a GIANT 340 Mb 13 ms IDE hard drive with a 64K cache.

But there's more - we've added an IDE caching controller that lowers hard drive access time to less than 0.3 ms! Fifty time faster. And this is superb Renegade quality as delivered to leading industry.

- ✓ Intel 80486 Processor
- ✓ 256K Cache RAM
- ✓ 8MB RAM
- ✓ 1.2MB 5.25" Drive
- ✓ 1.44MB 3.5" Drive
- ✓ 200MB 15 ms IDE Drive with 64K Multi-Segmented Cache
- ✓ 16-Bit VGA with 1MB Color SVGA Monitor
- ✓ 1 Parallel / 2 Serial Ports
- ✓ 101-Key Enhanced Keyboard
- ✓ Microsoft Mouse
- ✓ MS DOS 5.0
- ✓ MS Windows 3.1

YOU WON'T BELIEVE HOW MUCH YOU CAN GET FOR YOUR MONEY WITH A RENEGADE 486. CALL TOLL-FREE NOW FOR SPECIAL PRICES!

1-800-825-8086
 Quantities are Limited



Circle 295 on Inquiry Card.

HANDSCOPE 12 bits COMPUTER-CONTROLLED MEASURING INSTRUMENT

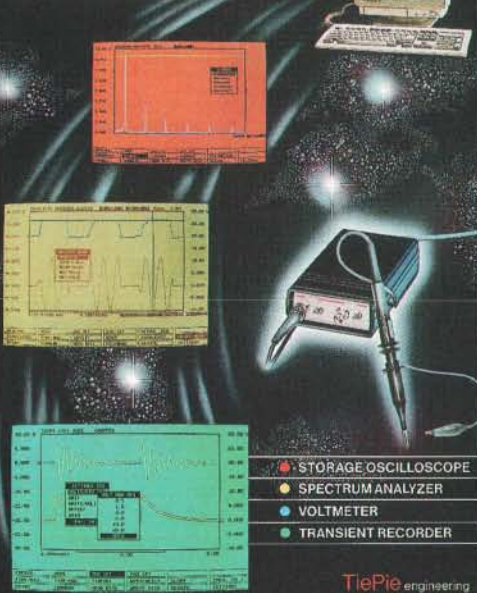

- STORAGE OSCILLOSCOPE
- SPECTRUM ANALYZER
- VOLTMETER
- TRANSIENT RECORDER

TiePie engineering

CALL for FREE demo diskette and information NOW:
COMPLETE SYSTEM \$449!
TIEPIE engineering
 Tel: (31) 5106 238 Fax: (31) 5106 704
 Battenserreed 2, 9023 AR Jorwerd
 The NETHERLANDS

The HANDSCOPE is a unique data acquisition instrument to be connected to the printer port of the computer (desktop, laptop, notebook), without external power supply. **HARDWARE:** 12 bits 100KHz, Sample & Hold, PGA (0.5-2-5-10 and 20 volt), two switchable probes (1:1, 1:10). **Data acquisition SOFTWARE:** two channel storage oscilloscope, spectrum analyzer, voltmeter, transient recorder.

Circle 284 on Inquiry Card.



Get the right connections for \$179.
The MiniSCSI™ Parallel-to-SCSI Adapter

Add a SCSI port to almost any printer port with our pocket-sized, self-contained **MiniSCSI**. Ideal for laptops, notebooks and systems which can't accommodate a standard SCSI interface, the **MiniSCSI** also lets you relocate SCSI devices easily.

- CD-ROM, hard disk, magneto-optical, SyQuest & Bernoulli support
- SCSI tape support available
- Retains use of parallel port
- Powered by SCSI bus
- Lightweight (only 2.5oz.)
- 2-year parts & labor warranty
- Other SCSI adapters available

"Genuinely interesting hardware department... Good idea"

John C. Dvorak, PC Magazine

"The neatest gadget at the CD-ROM show"

Jerry Pournelle, InfoWorld



Trantor Systems, Ltd.

5415 Randall Place,

Fremont, CA 94538-3151 USA

(510) 770-1400 • Fax: 770-9910

Call: 510-770-1400

Reseller Inquiries Welcome

© 1992, Trantor Systems, Ltd. All product names are trademarks or registered trademarks of their respective owners

Circle 281 on Inquiry Card.

NEW SHARE A SIGEN 250MB PORTABLE TAPE BACKUP & REDUCE COST/USER NEW

No controller card required. Connects to parallel port. Installs in less than 3 minutes. Great for Laptops. 9.5 MB/min transfer rate.

Capacity

60/100 MB 1/4" cartridge
 250/500 MB 1/4" cartridge
 1200/2000 MB 4mm DAT



Supports
 DOS, OS/2
 Novell 286, 386
 Unix, Xenix

Industry standard SYTOS Plus software and for file server based NLM and VAP Tapeware.



SIGEN

Phone (408) 737-3904 • Fax (408) 737-3910

Circle 273 on Inquiry Card.

Datapath Diskette Duplication Systems

Get exactly the duplication system you need...today!



- Complete duplication equipment product line
- Desktop Autoloaders
- Extended Hopper "production" Autoloaders
- PC and Mac based
- Expandable
- Runs 3.5" and 5.25" copy drives simultaneously
- Multiple formats including IBM, Apple and Amiga
- Standalone option
- High-speed copy drives
- High-performance "commercial" systems
- Prices starting at \$1995
- For more information, or to order, call 510-651-5580 or FAX 510-651-7814

Datapath

Circle 252 on Inquiry Card.

twiddler™

The mouse that can type!

- Pocket-sized, hand-held mouse pointer with the full power of a 101-key keyboard.
- Totally new, portable design: desktop-free mouse with touch-typable keyboard.
- Use with or without your existing keyboard.
- Reviewed in Byte, March 1992, page 51.
- \$199.00



Call: 1-800-638-2352

HANDYKEY CORPORATION

141 Mt. Sinai Ave., Mt. Sinai, NY 11766

Circle 305 (RESELLERS: 306) on Inquiry Card.

CUSTOM KEYBOARD PRODUCTS

- Custom Key Imprinting—all brands!
- Custom Colored keys for IBM®, DEC®, Wyse®, Key Tronic®, Cherry®, and more!
- Full color keyboard templates made to your exact specifications.
- Custom and stock keytop label kits for software support & languages.
- Custom membrane & full-travel keyboards.
- Express turnaround services.
- A total line of keyboard enhancements.



CUSTOM HOTLINE 800 937-1337
from the leader in Keytop Innovations™

P.O. Box 230 • Dept. BYTE
 Cornville, AZ 86325

Hooleon CORPORATION

602 634-7515
 FAX 602 634-4620

Circle 256 on Inquiry Card.

1.1 gigabytes in a Toshiba laptop?

**Not yet.
 But check with us
 in mid '92...**

**UP TO 525 MB
 FOR LAPTOPS**

DOS • OS/2 • UNIX • WINDOWS

**UP TO 180 MB
 FOR NOTEBOOKS**

Right now, we can install the capacity you need, from the smallest Toshiba notebook to the largest laptop.

Our faster (12-25 ms access time), higher-capacity drives won't add bulk or weight. Some are even lighter than the original drives.

Laptop Solutions' unique upgrade packages are thorough and complete. They're installed by appointment only, with a guaranteed 48-hour turn-around, including 24-hour burn-in and stringent testing to industry standards.



(800) 683-6839

Laptop Solutions, Inc.

Finally, you can put your laptop to work, the way you work!

10700 Richmond Ave., #114

Houston, Texas 77042

Phone: (713) 789-0878

FAX: (713) 789-8177

Quantity discounts available.

Circle 290 on Inquiry Card.

Memory/Chips/Upgrades

Why Pay More For Memory?

SIMMS		LAPTOP MEMORY	
256K x 9-70	\$13	AST-Ex. Notebook 1MB	\$72
1MB x 9-60	\$42	EVEREX-Tempo 2MB	\$98
1MB x 9-70	\$36	TI-Travelmate 2000	
1MB x 9-80	\$35		
4MB x 9-60	\$146	Sharp-G220 1MB	\$98
4MB x 9-70	\$132	HP-95LX, Paget PC	\$98
4MB x 9-80	\$125		
256K X 36	Call	512K	\$169
2MB X 36	Call	Compaq	
Laser Printer Memory		LTE 386s/20 1MB	\$125
Canon 1MB	\$125	4MB	\$296
LBP 8II/8IIR/8IIT 4MB	\$190	LTELite/20.5 2MB	\$195
Epson EPL-6000 2MB	\$125	4MB	\$289
4MB	\$190	8MB	\$625
Epson EPL-7000 2MB	\$135	LTE/286 1MB	\$99
Epson 2MB	\$125	2MB	\$149
Action Laser		SLT/286 1MB	\$99
Brother 2MB	\$138	4MB	\$269
HL-4/4V/PS 4MB	\$190	IBM-140SX/356X 2MB	\$109
Brother 2MB	\$170	4MB	\$189
HL-8E/8D/8V 4MB	\$225	8MB	\$375
Apple 4MB	\$225	Toshiba - T1000SE/LE/XE, T2000SX, T1000LE, T2000-SX, T2000SX	
Laser Writer II, IIINT, IIINTX 2MB	\$155		
HP LaserJet IIP/- 2MB	\$115		
IIP PIs/II/IIID/IIIP 4MB	\$180		
HP LaserJet 2MB	\$120	Toshiba -T1600, T3100E, T3100SX, T3200SX, T5100, T5200, C, T8500	
II, IID, 4MB	\$185		
HP LaserJet IIIsI 4MB	\$175		
T.J. Microlaser 1MB	\$75		
Sharp JX9500 1MB	\$75		
OKI Laser OL400 2MB	\$120		
OL800/820 2MB	\$135		
4MB	\$210		
Panasonic 4MB	\$135		
KXP4420, 44501 2MB			
KXP4455 2MB	\$196		

We carry Memory for all desktops, laptops notebooks, laser printers and workstations. **We will beat any advertised price.**

Memory Pipeline (800) 262-7466

Canada (800) 231-SIMM USA (805) 984-5683

Circle 286 on Inquiry Card.

Memory/Chips/Upgrades • Misc. Hardware

ICs PROMPT DELIVERY!!! Same day shipping (usually) Quantity one prices shown for April 19, 1992

Memory for almost ALL computers		80486, 50 MHz \$700	
DYNAMIC RAM		4464	64Kx4 100ns 1.40
4M Board for hp LJ's w/2MB	\$125.00	EPROM	
SIMM 4Mx9 70 ns	137.00	D28F010	128Kx8 150 ns \$24.00
SIMM 1Mx9 40ns	80.00	27C1000	128Kx8 200 ns 6.30
SIMM 1Mx9 53ns	65.00	27C512	64Kx8 120ns 4.75
SIMM 1Mx9 60ns	47.00	27128	16Kx8 250ns 2.95
SIMM 1Mx9 80ns	38.00	STATIC RAM	
4 Mbit 4Mx1 80ns	22.00	1 Mbit	128Kx8 Real \$21.50
4 Mbit 1Mx4 80ns	22.50	62256LP	32Kx8 100 ns 5.60
1 Mbit 1Mx1 70 ns	4.50	Sat. del. on Fed-Ex orders received by: Th: S-2 1-4 lbs \$6.25 Fr: P-1 1 lb \$17.00 FED-EX COD +\$5.00	
41256 256Kx1 80 ns	1.75		
44256 256Kx4 80ns	4.85		

OPEN 6 1/2 DAYS, 7-30 AM-8:00PM • SHIP VIA FED-EX ON SAT.
MICROPROCESSORS UNLIMITED, INC
24,000 S. Peoria Ave., Beggs, OK 74421
MasterCard/VISA or UPS CASH COD • No minimum order.
\$1 for packing materials. Shipping and insurance extra.
(918) 267-4961

Circle 263 on Inquiry Card.

BYTE

Breaks the 4-Color Price Barrier
with the **Hardware/Software Showcase**

See how affordable it is to advertise to BYTE's 500,000 computer professionals in this section!

Call for more advertising information:
(603) 924-2695 or (603) 924-2598

Circle 277 on Inquiry Card.

MEMORY UPGRADE KITS FOR
Desktops, Laptops, Notebooks, Laser Printers

IBM COMPAG HP AST PANASONIC
CANON TOSHIBA TI EPSON OKIDATA

THIS MONTH'S SPECIALS

IBM MEMORY	HEWLETT-PACKARD MEMORY	TOSHIBA LAPTOP MEMORY	COMPAG LAPTOP MEMORY
PS/2 30-396	IIP III IID IIP	T1000 LE/SE/XE	LTE 286
512K/2 MB	II IID	T2000SX	1MB/2MB
\$35/\$109		1MB/2MB	\$75/119
PS/2 70 55ax	1MB/2MB/4MB	\$99/139	LTE 386s/20
50x 65ax	\$75/109/195	T3100SX/3200SX	1 MB/4MB
1MB/2MB/4MB		T3100E / 2MB / \$119	\$159/359
\$59/109/229			444-1341

BPS INTERNATIONAL
116 W. Service Rd., Suite 152, Champlain, NY 12919
Fax: (514) 695-4811 Tel. (514) 695-1569

* 30-Day Money-Back Guarantee • 5-Year Warranty • 100% Compatibility Guarantee on Memory Products! • 5% Discount for Cash Payment! • No Surcharge on Credit Card Payments! • Corporation, University, Government, PO's accepted. • Various shipping options available. • Call for special prices on memory products not listed! • Other specialty priced products include postscript, font cartridges, additional trays for HP lasers, TOSHIBA & COMPAG laptops, TI notebooks, HP & OKIDATA laser printers. • Prices & availability subject to change without notice.

Circle 299 (RESELLERS: 300) on Inquiry Card.

SCSI BUS EXTENDER



- Conditions and Regenerates SCSI Bus
- Isolate Noisy Cables & Peripherals
- Extend Distance to Peripherals
- Increase SCSI Bus Performance
- Supports "Fast SCSI" (10 MBytes/sec)
- SCSI 1 and SCSI 2 Compatible
- No additional software required

\$ 295.00

CALL TODAY 1-800-624-6808

APPLIED CONCEPTS

30 DAY MONEY BACK GUARANTEE

APPLIED CONCEPTS, INC.
5350 Eastgate Mall
San Diego, CA 92121
TEL: 619-453-0090
FAX: 619-453-6715

Circle 245 on Inquiry Card.

2059 Camden Ave., #330 San Jose, CA 95124

AmRam 408-559-0603

1MB SIMM 80ns \$40 4MB SIMM 80ns \$130

TYPE	PKG.	80ns	60ns	— MATH CO-PROCESSORS —		
256K x 1	DIP	\$0.82	\$1.47	80287-XL	\$82.35	83587-25 \$117.65
256K x 4	DIP	\$4.76	\$4.76	80287-XLT	\$82.35	83D87-33 \$164.71
1M x 1	DIP	\$4.18	\$4.59	80387-SX25	\$120.75	83D87-40 \$200.00
256K x 9	SIMM	\$11.29	\$11.47	80387-DXP	\$199.00	2C87-12 \$64.71
1M x 9	SIMM	\$40.00	\$40.88	80487-SX	\$481.18	2C87-20 \$70.59
4M x 9	SIMM	\$130.00	\$139.15			

LOW WAREHOUSE PRICES!

All Merchandise 100% guaranteed. We accept VISA, MC, Discover and company PO's with prior approval. Price, delivery & manufacturer subject to change. Minimum order \$100.00. Returns require RMA; non-defective returns subject to 15% restocking fee.

Circle 258 on Inquiry Card.

REDUCE PC FAN NOISE BY 98%...

THE SILENCER is an electronic device which monitors the internal temperature within your PC/Laser Printer and reduces the fans speed (and noise) to ensure proper cooling is achieved - BUT NO MORE... Typical noise reduction is 80% to 98%...

Easy to install; built-in fail-safe, and 3 year warranty. *THE SILENCER* has to be heard (or not) to be fully appreciated. Take advantage of our 30 DAY NO RISK TRIAL OFFER... and join the thousands of PC users worldwide who now enjoy *THE SILENCER*.



Mini-12VDC Silencer..... \$69.95
Fail-Safe DC-Silencer..... 99.95
Laser Printer Silencer..... 99.95
AC-Fan Silencer..... 99.95

To Order Call 1-800-SILENCE

QUIET TECHNOLOGY INC.
P.O. Box 18216
West Palm Beach, FL 33416
Dealer Info./Fax: 407/683-6200

Circle 283 on Inquiry Card.

The Printer Sharing Works



PrintCube



LaserCard



LaserCard Si



- Starting at \$295, guaranteed high performance printer sharing.
- Connect any combination of PCs, Macs, HP mini's, DEC's, or LANs hundreds of feet away using low cost 4 wire telephone cables.
- Three desktop PrintCube models for sharing any two printers, including Wilco's powerful Fax-Printer system.
- Eight plug-in LaserCards for sharing HP LaserJet II, III or IIISi printers.
- More than 10,000 systems installed.

Call Wilco AMS
800-854-6548
 Workgroup Printing and Faxing Solutions

Circle 294 on Inquiry Card.

Universal Programmer from \$745

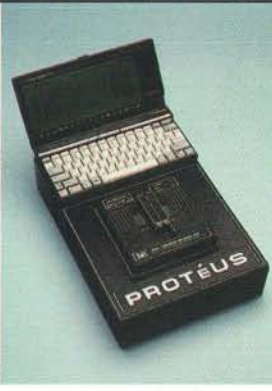

- Programs and Tests over 3,000 devices
- Memory (up to 8MB), FLASH, SERIAL EPROMs. All Intel/Signetics MICROs; Motorola 705, C11; PLDs: AMD MACH, PALCE; LATTICE GALs, LSI1032; ALTERA 6XX, 9XX, 18XX; NS MAPLE, GALs; CYPRESS MAX, CY7361
- Universal PLCC adapter (up to 84 pins)
- Gang Adapters for Memory, Micro, PCMCIA cards
- Up to 104 fully protected pins; 100W P.S.
- Standard parallel printer port
- Fully integrated Algorithm Development Language allows users to add/change parts
- True State Machine Testing capability
- True full Selfcalibration & Diagnostics
- Certified by all major device manufacturers

Low Cost Programmer from \$345

- 32 pin E/EPROMs to 4MBytes, Flash EPROMs, Intel Micros
- Gang Module (4 sockets), Motorola Micros Module
- RS232 interface; internal eraser option; Stand-alone capability

Intelligent Rom Emulator from \$395

- "In-Circuit-Emulator" type features: Address Compare (with HALT output), Address Snapshot, Trigger Input, Reset Output
- Standard parallel Printer Port (64Kbytes in 10 seconds)
- Stand-alone operation (rechargeable NiCad battery)



750 N. Pastoria Ave. Sunnyvale, CA 94086 USA
 Tel: (408) 730-5511 Fax: (408) 730-5521

Circle 246 on Inquiry Card.

BYTE

Breaks the 4-Color Price Barrier
 with the Hardware/Software Showcase

See how affordable it is to advertise to BYTE's
 500,000 computer professionals in this section!

Call for more advertising information:
 (603) 924-2695 or (603) 924-2598

IEEE 488.2

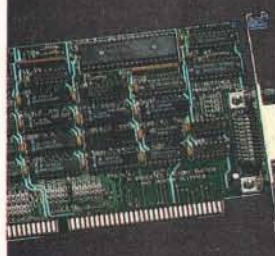

Hardware for IBM PC/AT, Micro Channel, Sun, Macintosh, DEC, and NeXT.

Software for DOS, Windows, UNIX, VMS, menu- and icon-driven environments.

IEEE 488 extenders, analyzers, converters, analog I/O, and digital I/O.

Call for your free IEEE catalog



IOtech, Inc. • 216.439.4091 • Fax 216.439.4093

Circle 257 on Inquiry Card.

200 MHz Logic Analyzer



- 400 MHz max sampling rate
- up to 128 channels
- 16K samples/channel
- 16 level triggering
- Variable threshold voltage
- Sophisticated triggering
- FREE software updates

\$799 - LA12100 (100 MHz)
 \$1299 - LA32200 (200 MHz-32-ch.)
 \$1899 - LA32400 (400 MHz-32-ch.)

Price is complete.
 Pods and software included.

POWERFUL • AFFORDABLE INSTRUMENTS

Universal Programmer

PAL
 GAL
 EPROM
 FLASH
 EEPROM
 PROM
 87xxx...

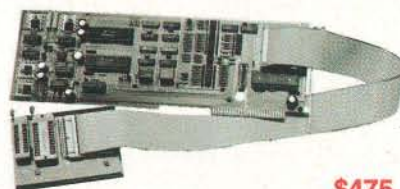

\$475

- *16V8, 20V8, 22V10, GALs
- *26V12, 20RA10, 18V10 GALs
- *2716-27040 EPROMs
- *87xxx MICROs
- *EEPROMs (incl. 8 pin serial)
- *16 bit EPROMs
- *Byte Split/Merge (16 & 32 bit)
- *JEDEC, INTEL HEX, Motorola 'S' files
- *Dallas NVS RAM programming
- *FREE software updates on BBS

Call - (201) 808-8990

Link Computer Graphics, Inc.

369 Passaic Ave., Suite 100, Fairfield, NJ 07004 FAX: 808-8786

Circle 261 on Inquiry Card.

Programmable Hardware

EPROM EMULATOR / PROGRAMMER

• High powered and versatile unit combines an emulator with a programmer to allow one step firmware design or trouble shooting. • Operates with any computer or terminal using RS-232 port. • Emulates, programs, copies and verifies 2716-27512 EPROMs and 2816-28256 EEPROMs (no emulation). • Easy to master emulation & programming features. • Battery backed up memory allows unit to auto-run user's firmware on startup. • Simple to use byte exchange feature allows microprocessor register dumps and user break points. • Ideal development or service tool for multi-processor users. • Light weight and portable unit easily fits in tool box or brief case.



\$499

Phone: 902-468-5911

Fax: 902-468-5912

OMNITECH ELECTRONICS INC.

10 Akerley Blvd., Dartmouth, Nova Scotia, Canada B3B 1J4

Circle 291 on Inquiry Card.

UNIVERSAL PROGRAMMER, EMULATOR, & TESTER

TUP-400 \$745.00 NEW
TUP-300 \$645.00

- New Improved hardware and software.
- The most complete PC-based Universal Programmer, Programs PLD (PAL, GAL, FPL, EPLD, PEEL, MAX, MACH...), E(E)PROM, (up to 16Mbit), Flash EPROM, BFPROM, Special PROM, MPU (87XX, 68XX, Z8, PSD301, PIC16XX, TMS320EXX, UPD75PXXX, HD637XXX...).
- Covers DIP, PLCC, QFP, SOP, and PGA with 8 to 84 pins. Gang Programming adapters available also.
- EPROM EMULATION capability.
- Tests digital ICs and DRAMs (SIMM/SIP adapter available).
- Free software updates and new device added upon request.
- IC Manufacturers' approval.
- 1-year warranty, 30-day money-back guarantee.

CALL TODAY FOR MORE INFORMATION.
Distributors are welcome!



Tribal Microsystems Inc. Tel (510) 623-8859
44388 S. GRIMMER BLVD., FREMONT, CA 94538 FAX (510) 623-9925

Circle 275 on Inquiry Card (RESELLERS: 276).

SUPERPRO®
now \$599 (US only)

Over 2,000 devices, desktop programmer for your IBM PC with high speed & reliability

- Easy to use menu driven Software.
 - Universal programming for E(E)PROM, Flash E(E)PROM, Bipolar PROM, PAL, FPL, PEEL, GAL, E(E)PLD, & Microcontroller, etc.
 - Test TTL/CMOS logic ICs, & memory (DRAM/SRAM).
 - Life time free Software updates on BBS & technical support.
 - 1 year Hardware warranty & 30 day money back guarantee.
 - Developed & made in U.S.A.
 - Call for demo disk.
- Distributors are welcome!!



EPROM programmer
• ROM MASTER: \$149
Low cost universal programmer
• UNIPRO: \$399
764 San Aleso Avenue Sunnyvale, CA 94086
(408) 745-7974
FAX 745-1401 BBS 745-7256

XELTEK

Circle 279 on Inquiry Card.

MICROCONTROLLERS

- C Programmable
- Data Acquisition
- Control / Test
- Excellent Support
- From \$159 Qty 1
- New Keyboard Display Modules

Use our Little Giant™ and Tiny Giant™ miniature controllers to computerize your product, plant or test department. Features built-in power supply, digital I/O to 48+ lines, serial I/O (RS232 / RS485), A/D converters to 20 bits, solenoid drivers, time of day clock, battery backed memory, watchdog, field wiring connectors, up to 8 X 40 LCD with graphics, and more! Our \$195 interactive Dynamic C™ makes serious software development easy. You're only one phone call away from a total solution.



Z-World Engineering

1724 Picasso Ave., Davis, CA 95616 (916) 757-3737 Fax: (916) 753-5141
Automatic Fax: (916) 753-0618 (Call from your fax, request catalog #18)

Circle 280 on Inquiry Card.

Tape Drives

9 Track/3480 Tape Subsystems
1/4" DAT 8mm Optical

- Best Quality
 - Lowest Prices
- 800/1600/3200/6250 BPI

CALL 1-800-886-4827



Laguna Data Systems

23151 Alcalde Drive, Suite B-3, Laguna Hills, CA 92653
Tel: 714-586-3010, Fax: 714-586-5538



Circle 260 on Inquiry Card.

Desktop 9-Track Tape Subsystem
#1-selling 9-track system on desktop.



Qualstar's low cost 1/2-inch 9-track Streaming tape systems bring full ANSI data interchange to IBM AT, PS/2 or Macintosh, giving your micro the freedom to exchange data files with nearly any mainframe or minicomputer in the world.

Systems include DOS or Xenix compatible software, coupler card and cables. High reliability 1600 or 6250 BPI capability may be used for disk backup as well as data interchange.

QUALSTAR®

Call us today! For details and to order: Fax (818) 882-4081
Phone (818) 882-5822

9621 Irondale Ave., Chatsworth CA 91311

©1989 Qualstar Corp.

All product and company names and trademarks are the exclusive property of their respective owners.

Circle 268 on Inquiry Card.

PC 9-Track
& 3480

- ✓ Widest choice of solutions
- ✓ Modern desktop subsystems
- ✓ Plug-and-play, easy to use
- ✓ Comprehensive software
- ✓ Excellent service and support

Call now for more information
and a free catalog.



800-729-8725
OVERLAND DATA

In Europe call:
49-6172-35027
fax: 49-6172-35028

PH: 619-571-5555

San Diego, CA

FAX: 619-571-0982

Circle 265 on Inquiry Card.

COMPUTER BOOKS at a discount



No clubs, memberships, or cards to return. Just the books you want at really great prices!

	COMPARE	
Call toll free for titles you don't see or to get catalog!	List	Ours*
Windows 3.1 Secrets, IDG, 980 pgs, 3 disks, 20% off	39.95	31.95
Windows Systems Programming, Abacus, 744 pgs, 1 disk	39.95	34.05
Maximizing Windows 3, NRP, 720 pgs, 1 disk	39.95	33.95
Running LANtastic, Bantam, 608 pgs	27.95	23.85
Borland's C++ Program'g for Windows, Bant., 864 pgs	29.95	25.55
Quattro Pro in Business, SAMS, 400 pages, 1 disk	29.95	25.55
ObjectVision Developer's Guide, Bantam, 640 pgs	26.95	23.05
Clipper 5: A Developer's Guide, M&T, 1349 pgs, 1 disk	44.95	38.20
Paradox 3.5 Power Prog Tech, IDG, 754 pgs, 1 disk	39.95	33.95
Windows 3.1 Prog Ref-Vol 1-4, MSPress, 2280 pgs	122.80	104.38
Using Visual Basic, Addison-Wesley, 432 pages, 1 disk	34.95	29.85
Norton's Windows 3 Power Program'g, Bant., 960 pgs	29.95	25.55
DRDOS 6.0 Complete, Abacus, 840 pgs, 1 disk	39.95	33.95

*add \$3.25 per book US shipping. Call for other shipping rates or see catalog.

BOOKS FROM: IDG, Peachpit, Osborne, QUE, NRP, Bantam, Windcrest, Hayden, Brady, MIS:Press, Sybex, Sams, Microsoft, Yourdon, TAB, Microtrend, Abacus, M&T, Prentice-Hall, Waite Addison-Wesley, Wordware, McGraw-Hill and many others.

CompuBooks  Order Line (800) 880-6818
 The Discount Computer Book People Hours: 8 AM - 5 PM CST Mon to Fri
 Route 1, Box 271-D Voice line 512-321-9652
 Cedar Creek, TX 78612

GO CBK 24 hrs.on CompuServe  

Circle 287 on Inquiry Card.

What have Mercedes, Motorola and 3M in common?
 They all make high-quality products. And they all use our PC Board Software.

 **EAGLE 2.6**
 Schematic • PCB Layout Editor • Autorouter

Many many other well-known big companies as well as middle-sized and small businesses use EAGLE for designing their PC boards. Why?

□ Unlike many other PCB programs, EAGLE has virtually no limitations. You can design any board on your AT compatible computer which can be manufactured.

□ EAGLE is very low priced and already with the first layout you will receive an immediate return on your investment.

□ EAGLE is very easy to understand and to use. This again saves you money.

What do experts say about EAGLE?
 The Dec. 91 issue of EDN listed EAGLE as one of the best products of the last six months. Electronics World + Wireless World: "...it will quickly become the sort of tool that you cannot live without..."
 But we want you to find out yourself. Call for our working demo which comes with the original manual.

EAGLE Demo \$ 12
EAGLE Layout Editor \$399
inc. drivers and libraries
Schematic Module \$399
Autorouter Module \$399

To order call toll-free 1-800-858-8355

 CadSoft Computer, Inc. • 801 S. Federal Highway
 Delray Beach, FL 33483 • Fax (407) 274-8218

Circle 304 on Inquiry Card.

HiWIRE II Schematic and PCB Software
 With support for expanded and extended memory, HiWIRE II can handle your most demanding schematic and PCB designs. The unique HiWIRE II editor allows you to display and edit schematics and PCBs simultaneously, using the same commands for each. HiWIRE II is \$995, and is guaranteed. Call (800) 742-6809 or (317) 448-1903

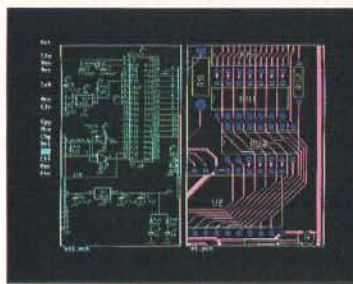

WINTBK
 Wintek Corporation
 1801 South Street
 Lafayette, IN 47904
(800) 742-6809

Circle 278 on Inquiry Card.

EM320
WINDOWS

DEC VT320 Emulation for Microsoft Windows 3.0

- 132 column display
- Automatic window sizing
- Cut and paste
- Double high/wide characters
- Kermit file transfer
- LAT or TCP/IP support
- Windows style help
- Modem dialer/Phone book
- Local or ANSI color
- Command language

Diversified Computer Systems, Inc. (303) 447-9251
 FAX (303) 447-1406 Tektronix 4105/07 Emulation also available

Circle 253 on Inquiry Card.

WEATHERLINK
 The Ultimate In Weather Monitoring!

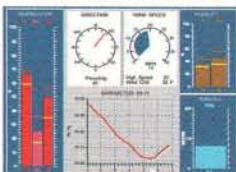

- Create daily, weekly, monthly, yearly plots
- Compare two weather conditions on the same graph
- Plot two days, weeks, months, or years on the same graph
- Store data for up to 4 months before transferring to the PC
- Monitor conditions at remote locations using a modem

The ultimate in weather monitoring systems, Weatherlink works with any of Davis' weather stations to bring the weather to your PC!
 • IBM compatible, 640K RAM required • Hercules, CGA, EGA, and VGA

Call Today: 1-800-678-3669 M-F 7 a.m. to 5:30 p.m. Pacific Time
 30-day money-back guarantee • M/C and VISA • FAX 1-510-670-0589 • BY818U

DAVIS INSTRUMENTS 3465 DIABLO AVE., HAYWARD, CA 94545

Circle 301 on Inquiry Card.

PAPER KEYBOARD 

Fast, affordable data entry!

OCR, OMR, hand print recognition software
 Scan and recognize using Windows DDE

Works with Visual Basic, ObjectVision and Others
 HP, Microtek, Pentax, Fujitsu scanners and fax modems

Datacap Inc. 914 347-7133 Fax: 914 347-7136

Circle 251 on Inquiry Card.

EARN YOUR COLLEGE DEGREE AT HOME

B.S. & M.S.

In Computer Science

Get the opportunity and earning power a college degree confers—without leaving home and without spending thousands of dollars.

- Approved for tuition reimbursement by leading corporations
- ALL COURSES BY CORRESPONDENCE
- Most courses interactive
- Approved Ada course available
- Qualified instructors available on telephone help lines

Phone: 1-205-323-6191 • FAX: 1-205-328-2229
2101 BYX Magnolia Ave. • Suite 200 • B'ham, AL 35205

AMERICAN
INSTITUTE
FOR
COMPUTER
SCIENCES
The leading edge of learning

FLOW CHARTING 3

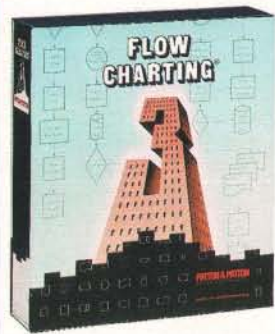

Powerful new features – for greater speed, flexibility, and ease-of-use!

- Single-page, multi-page or canvas charts – portrait or landscape
- Custom fonts support high resolution laser and 24-pin dot matrix printers
- 35 standard shapes, 10 text fonts
- Suggested retail price: only \$250

See your dealer today! or, for a "live" interactive demo disk, call: 800-525-0082, ext 1218
International: 408-778-6557, ext 1218
fax: 408-778-9972

PATTON & PATTON
Software Corporation

Circle 266 on Inquiry Card.

ROMboy

Low Cost, Reliable, High Quality ROM Emulation from the Creators of PROMICE



- Emulation of up to 1 Mbit ROMs (4 Mbit - soon)
- Supports any ROM type (DIP or PLCC)
- Supports high speed ROMs
- Supports any word size up to 2048 bits wide
- Host software for DOS, Unix, Mac, VMS
- Battery backed memory
- Intelligent micro-controller based unit
- SMT CMOS layout for robustness
- Tiny size: 2.5" x 3.8" x 0.9"
- Unbelievably low price! \$295

ROMboy...
from the authority in firmware development tools

Orders: (614)471-1113
West: (415)750-0219
FAX: (614)475-6871



Circle 302 on Inquiry Card.

Cross Assemblers, Simulators, Disassemblers



Processor Families:

8051	8096	8048
Z80	64180	6301
6805	6800	1802
6811	6502	68k
8085	6801	Z8

Join Thousands of Satisfied Customers Worldwide.

Call:

PseudoCorp

716 Thimble Shoals Blvd., Newport News, VA 23606
Tel: (804) 873-1947 • Fax: (804) 873-2154

Circle 267 on Inquiry Card.

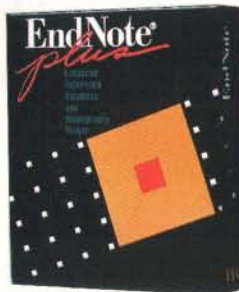

New Bibliographies in Seconds!

A powerful database that works with WordPerfect and MS Word for DOS, Windows and the Mac.
Niles and Associates, Inc.,
2000 Hearst Ave. Suite 200
Berkeley, CA 94709
1-800-554-3049

Perfect for research papers. See page 80 in the December 91 issue of Byte. 30-Day Money-Back Guarantee.

Circle 285 on Inquiry Card.

TURN YOUR PRINTER INTO A PEN PLOTTER

FPLOTT™ lets you use your printer as a pen plotter. You get fast, high resolution plots with FPLOT. If you use a CAD or graphics program, you can use FPLOT to produce your plots with the full capabilities of your printer.

- Supports most dot matrix, laser, and ink jet printers
- High resolution output, no jagged lines
- Faster than pen plotters or most laser built-in and cartridge emulations
- Screen preview with zoom and pan
- Supports background plotting
- Device driver mode plots from inside your graphics program
- Stand-alone mode for fastest plotting
- Plot multiple plots with a single command
- Lets you control line thickness
- Full color plotting support
- Plot large plots on wide carriage printers, or as a mosaic
- Compatible with most CAD and graphics programs
- 100% emulation of the HP 7475A pen plotter

List Price
\$119.00
+ S&H 3.00

FPLOT CORP.

24-16 STEINWAY STREET, SUITE 605
ASTORIA, NEW YORK 11103
(718) 545-3505

Circle 254 on Inquiry Card.

JMP® Statistical Discovery Software

"JMP, from the SAS Institute, is the most surprising Mac product in years...with the most helpful

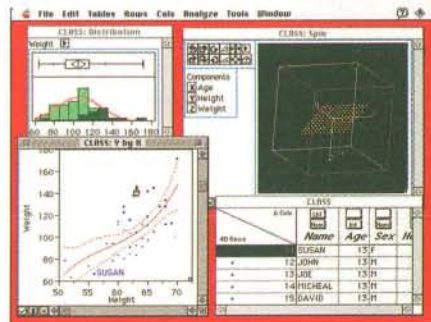

Mac interface of all the statistics programs and one of the best interfaces ever produced for scientific software. It's nothing less than dazzling."

MACWORLD

Call today for a free demo disk and Points of Interest from the leading name in data analysis software...SAS Institute Inc.
919-677-8000. Fax 919-677-8166.

JMP is a registered trademark of SAS Institute Inc.
Copyright © 1992



Circle 269 on Inquiry Card.

THE BUYER'S MART

A DIRECTORY OF PRODUCTS AND SERVICES

THE BUYER'S MART is a monthly advertising section which enables readers to easily locate suppliers by product category. As a unique feature, each BUYER'S MART ad includes a Reader Service number to assist interested readers in requesting information from participating advertisers.

Effective January 1, 1992.

RATES: 3 issues-\$625 6 issues-\$600 12 issues-\$525 13 issues \$500

Prepayment must accompany each insertion. VISA/MC Accepted.

AD FORMAT: Each ad will be designed and typeset by BYTE. Advertisers

must furnish typewritten copy. Ads can include headline (23 characters maximum), descriptive text (250 characters is recommended, but up to 350 characters can be accommodated), plus company name, address and telephone number. Do not send logos or camera-ready artwork.

DEADLINE: Ad copy is due approximately 2 months prior to issue date. For example: November issue closes on September 8. Send your copy and payment to THE BUYER'S MART, BYTE Magazine, 1 Phoenix Mill Lane, Peterborough, NH 03458. For more information call Margot Gnade at 603-924-2656. FAX: 603-924-2683.

ACCESSORIES

RADIOACTIVE?

Plot it on your PC with The RM-60 RADIATION MONITOR. Serial or printer port. Detects: ALPHA • BETA • GAMMA • X-RAY. MicroR, 1000 times the resolution of standard geiger counters. Excellent for tracking RADON GAS. Find sources. New; Version 2.8 + WINDCWS. Plot • Background • Cosmic Rays • Clouds • Foods. Call/Write for PC MAGAZINE review. • TSR • GM Tube VISA/MC/EURO Phone orders. Not satisfied? Full refund.

800-729-5397 or Tel/Fax: (302) 655-3800
Aware Electronics Corp.
 P.O.Box 4299, Wilmington, DE 19807 **\$149.50**

ACCOUNTING SOFTWARE

UNBEATABLE TRIO

THE BUSINESS MANAGER \$199.99/netwk/\$239.99
 The most integrated accounting system available. Tracks sales, quotes, inventory, and prints invoices.

PAYMASTER PAYROLL ACCOUNTING Single \$79.95
 Makes all deductions & prints payroll checks & W2 reports.

THE ORDER CENTER \$99.99/netwk/\$139.99
 Pop-up windows show inventory, quantity, price and back orders.

PIEDMONT DATA CORP.
 5511 Monroe Road, Charlotte, NC 28212
 1-800-343-3210

BAR CODE

PRINT BAR CODES/BIG TEXT FROM YOUR PROGRAM

Add bar codes and big graphics characters to your program. Print from ANY MS-DOS language. Bar codes: UPC, EAN, 2 of 5, MSI, Code 39. Epson, Oki, IBM dot matrix text up to 1/2". LaserJet up to 2". Font cartridges not required. \$179-\$239. 30-day \$\$ back.

Worthington Data Solutions
 417-A Ingalls St., Santa Cruz, CA 95060
(408) 458-9938 (800) 345-4220

CUT RIBBON COSTS

Re-ink your printer ribbons quickly and easily. Do all cartridge ribbons with just one inker! For crisp, black professional print since 1982. You can choose from 3 models:

Manual E-Zee Inker—\$39.50
 Electric E-Zee Inker—\$94.50
 Ink Master (Electric)—\$189.00

1000s of satisfied users. Money-back guarantee.

BORG INDUSTRIES
 525 MAIN ST., JANESVILLE, IA 50647
1-800-553-2404 In IA: 319-987-2976

AUTOMATION

DISTRIBUTED PROCESS CONTROL

Real-Time Plant Automation SCADA. Online control specification, dynamic plant mimics, alarm processing, trends, data archiving, reports, recipes, process overview, simulation facilities. Modbus I/O drivers and I/O specifications included. Demo system \$50. Full system \$750. Contact Dr. Etienne de Villiers at:

VVV PROCESS AUTOMATION
 P.O. Box 695, Parklands 2121, South Africa
Tel/Fax (+27)-11-646-8298

BAR CODE READERS

Keyboard emulation for PC/XT/AT & PS/2's, all clones and any RS-232 Terminal. Transparent to your operating system. Available with Steel wands, Lasers, Slot & Magstripe Readers. Same day shipping. 30-day money-back guarantee. One-year warranty. Reseller discounts available.

AMERICAN MICROSYSTEMS
 2190 A Regal Parkway, Euless, TX 76040
(800) 648-4452 (817) 571-9015 FAX (817) 685-6232

Inquiry 701.

Inquiry 706.

BAR CODE

KEYBOARD, VIDEO, MOUSE

Extension with **EXTENDER**
 Splitting with **COMPANION**
 Switching with **COMMANDER**

Boosts signals up to 600 feet. Control up to 96 PCs with one keyboard and monitor.

CYBEX CORPORATION
 2800H Bob Wallace Ave., Huntsville, AL 35805
Phone: 205-534-0011 Fax: 205-534-0010

LABELING SOFTWARE

On EPSON, IBM, OKI dot matrix or LaserJet. Flexible design on one easy screen. Any format/size. Up to 120 fields/label. 18 text sizes to 3'-readable at 100'. A1AG, MIL-STD, 2 of 5, 128, UPC/EAN, Code 39. File Input & Scanned logos/symbols (PCX)—\$279. Other programs from \$49. 30-day \$\$ back.

Worthington Data Solutions
 417-A Ingalls St., Santa Cruz, CA 95060
(408) 458-9938 (800) 345-4220

BAR CODE PRINTING SOFTWARE

- MS/PC DOS SYSTEMS
- 9 & 24 PIN DOT MATRIX
- H-P LASER JET/PLUS/SERIES II
- MENU-DRIVEN or MEMORY RECALL
- CODE 39, I 2/5, UPC A/E, EAN 8/13
- BIG TEXT & BAR CODE SOFTFONTS

AMERICAN MICROSYSTEMS
 2190 A Regal Parkway, Euless, TX 76040
(800) 648-4452 (817) 571-9015 FAX (817) 685-6232

Inquiry 702.

TAKING MAC OVERSEAS? We've Got 220V/115V Converters All Wattages
Your Converter & Cable Connection Source!
 Cables • Books • Computer Batteries
 No. California's Largest "In-Stock" Computer Supplies & Parts Inventory
(800) 321-4524 (CA)
(800) 548-7135 (US/Can)
ELECTRONICS PLUS Inc.

BAR CODE READERS

For PC, XT, AT, & PS/2, Macintosh, and any RS-232 terminal. Acts like 2nd keyboard, bar codes read as keyed data. With steel wand—\$399. Top rated in independent reviews. Works with DOS, Xenix, Novell, Alloy, -ALL software. Lasers, magstripe, & slot badge readers. 30-day \$\$ back.

Worthington Data Solutions
 417-A Ingalls St., Santa Cruz, CA 95060
(408) 458-9938 (800) 345-4220

PORTABLE BAR CODE READER

Battery operated, handheld reader with 64K RAM, 54 key keyboard, real-time clock, 2X16 LCD display, and built-in calculator. Supports WAND, CCD, and LASER. Built-in program generator supports multiple programs and data files. Interfaces to PC & PS/2 keyboards. RS-232 terminals, and HAYES compatible modems. 30-DAY MONEY-BACK GUARANTEE

AMERICAN MICROSYSTEMS
 2190 A Regal Parkway, Euless, TX 76040
(800) 648-4452 (817) 571-9015 FAX (817) 685-6232

Inquiry 703.

HEWLETT PACKARD

Buy - Sell - Trade

Laser Jet II/III Color Pro (7440)
 Laser 2000 2 Meg/4 Meg upgrades HP-7550A
 Desk Jet Draft Pro DXL/EXL
 Rugged Writer Draftmaster I/II
 Electrostatic Plotters C1600 (D Size) /C 1601 (E Size)
 Science Accessories Corporation Sonic Digitizers
 36" x 48" (2750) 60" x 72" (3175)

T. E. Dasher & Associates
 4117 Second Ave., S. Birmingham, AL 35222
Phone: (205) 591-4747 Fax: (205) 591-1108
(800) 638-4833

PORTABLE READER

Battery-operated, handheld reader with 64K static RAM, 2x16 LCD display, 32-key keyboard, Real-Time-Clock. Wand or laser scanner. Program prompts and data checking through its own keyboard. Easy data transfer by RS-232 port or PC, PS/2 keyboard. Doubles as On-Line Reader. 30-day \$\$ back.

Worthington Data Solutions
 417-A Ingalls St., Santa Cruz, CA 95060
(408) 458-9938 (800) 345-4220

BAR CODE READERS

Complete line of bar code reading hardware and software for PC/XT/AT/PS/2 & terminals. Reads all major symbologies (39, I2/5, UPC/EAN). Laser scanners, badge slot & mag stripe readers. We can assist in any stationary or portable application. 30-day \$\$ back. 1 year warranty. Reseller discount. We speak Spanish!

BARCODE INTERNATIONAL SYSTEMS
 9190 Palm Canyon Dr., Corona, CA 91719
(714) 277-1917 FAX: (714) 277-1005

Inquiry 704.

Inquiry 707.

BAR CODE

READ BAR CODES!

KNOW-WEDGE Laptop Edition
Complete with Wand only \$199.00.

For alternative hardware or software solutions

CALL

COMPUTER RESOURCES GROUP

629 Silverdale Dr., Claremont, CA 91711

VOICE: (714) 624-8734

BBS: (714) 626-1054

Inquiry 708.

BAR CODE WEDGE & WAND: \$188

(List \$300) **AGGRESSIVE PRICING!**...Software-transparent PC KEYBOARD EMULATION WEDGE DECODER autoselects all popular bar codes, with STAINLESS STEEL, RUBY-TIP WAND (RS-232 add \$30). MAGNETIC STRIPE readers/writers. PORTABLE READERS. OPTICAL MARK (test form) readers. TIMECLOCKS & facility entry security. LASERS, CCD scanners, slot (badge) readers. SOFTWARE for bar code printing. Reseller discounts. 30-day money back.

DATA HUNTER

6181 Medford, Huntington Beach, CA 92647
(714) 892-5461 Fax 714-892-9768

Inquiry 709.

I. T. S. Bar Code Solutions

Bar codes are easy using our FULL line of readers & printers. They plug and play with your existing CPU/printer/terminals/software systems in your office, store, truck, factory or warehouse. ITS' bar code DOS programs print on matrix or laser printers. 30 day refund. 1 year warranty. OEM/VAR/Dealer discounts.

International Technologies & Systems Corp.

655-K North Berry St., Brea, CA 92621 - Western USA
13 Welwyn Court, Richmond, VA 23229 - Eastern USA
(800) 228-9487 (714) 990-1880 (804) 741-6725 (FAX) 990-2503

Inquiry 710.

PC BAR CODE SPECIALISTS

Bar code readers designed for fast, reliable, cost-effective data entry. They emulate your keyboard, so scanned data looks just like it was typed in! Choose from stainless steel wand, laser gun, card slot reader, and magnetic stripe scanner. Also, powerful Bar Code and Text printing software. Great warranty. Generous dealer discounts.

Seagull Scientific Systems

15127 N.E. 24th, Suite 333, Redmond, WA 98052
206-451-8966 800-758-2001

BAR CODE LABELER

Menu driven program prints Code39, 12x5 Codabar, 128A, B, C, all auto. UPC-A/E. EAN-8/13 & add-ons, DUN-14/16. Avery laser label data supplied. You specify height, resolution. Prints functional, low cost bar code labels! \$99.00

SJ Programs

1127 S. Patrick Drive, S. 18, Satellite Beach, FL 32937
TEL: (407) 773-8020 FAX: (407) 773-0457

Inquiry 711.

BAR CODE DECODING SOFTWARE FOR PORTABLES PC'S

BAR-WEDGE is a TSR that allows you to read bar code without a decoder. The bar code read as keyed data. By connecting up the wand on the rs232 port, you just have to start the software and the reading can begin. Easy to use, full programmable, no power required, less than 4k, easy to integrate in your application.

SYMCO INC.

96 Arcand C.P. 57 Victoriaville, Qc, G6P 6S4
Phone: (819) 751-0095 Fax: (819) 751-1292

Inquiry 712.

BAR CODE

DATA INPUT DEVICES

Bar Code, Magnetic Stripe Readers & SmartCard Encoder/Reader for microcomputers & terminals, including IBM PS/2 & others, DEC, Macintosh, AT&T, CT, Wyse, Wang. All readers connect on the keyboard cable & are transparent to all software. UPC & 39 print programs, magnetic encoders, & portable readers are also available.

TPS Electronics

4047 Transport, Palo Alto, CA 94303

415-856-6833 Telex 371-9097 TPS PLA

1-800-526-5920 FAX: 415-856-3843

Inquiry 713.

VARIANT MICROSYSTEMS

BAR CODE READERS DELIVER WAND/LASER/MAGNETIC CARD CONNECTIVITY

- Keyboard wedges (Internal/External) for IBM PC/XT/AT, PS/2, and portables
- RS232 wedges for WYSE, Link, Kimtron terminals
- Bar code and label printing software
- Full two-year warranty
- 30-Day Money-Back Guarantee
- Extensive VAR/Dealer Discounts

46560 Fremont Blvd., Suite 206/Fremont, CA 94538/(510) 440-2670
800-666-4BAR FAX: (415) 623-1372

Inquiry 714.

BASIC LANGUAGE TOOLS

BASIC TOOLBOX - \$99

Advanced BASIC library for the serious MS BASIC PDS 7 & 7.1 and QuickBasic 4.5 programmer. Complete library comprised of nearly 350 routines including the following: file manipulation, string handling, mathematical, input fields, bit arrays, mouse, array management, memory manipulation, dos routines, list boxes, 2-D file scrolling/windowing, more.

CALL (409) 832-6510

AMERICAN DIGITAL TECHNOLOGY GROUP

PO Box 1375, Beaumont, TX 77704

Inquiry 715.

BOOKS/TECHNICAL

COMPUTER BOOKS OUR SPECIALTY

OVER 4400 TITLES IN STOCK.
MAIL, PHONE, SPECIAL ORDERS.

TAYLORS TECHNICAL BOOKS

5455 Belt Line Rd.
Dallas, TX 75240

214-239-TECH 800-926-READ Fax: 214-239-8527

Inquiry 716.

CAD

PCB & SCHEMATIC CAD-\$195

"EASY-PC" for single-sided and multilayer boards to 17"x17" with up to 1500 ICs including surface mount. Phenomenally fast and easy to use. Over 11,000 copies sold. Needs PC/XT/286/386 HERC/CGA/EGA/VGA. Output to laserjet/inkjet/dot matrix printer, pen-plotter, photo-plotter and NC Drill. Not copy protected. VISAMC/AMEX welcome. For full info circle inquiry # or contact us direct.

NUMBER ONE SYSTEMS LTD.

Harding Way, St. Ives, Huntingdon, Cambs, England, PE17 4WR
Tel: 011-44-480-61778 Fax: 011-44-48-494042

Inquiry 717.

VIEW CAD DRAWINGS

SirlinVIEW Allows non-CAD users to view AutoCAD DWG, DXF & HPGL files on PCs. Print, Plot, attach notes and hyper-link between files. Change views and layers. Accurate Query databases to locate & highlight objects on the screen. Also, linkable SirlinVIEW/LIB allows developers to add viewing capabilities to their own applications.

Sirlin Computer Corporation

25 Orchard View Dr., Ste. 14, Londonderry, NH 03053
(603) 437-0727 Fax: (603) 437-0737

Inquiry 718.

CAD/CAM

CONTOURING MOTION

FROM A PRINTER PORT!

NEW Indexer LPT™ software **\$249**
VERSION 3 VISA/MC

- Controls up to six step motors simultaneously.
- Linear and Circular Interpolation.
- New features to accommodate machine control.
- Easy-to-use DOS device driver. Super Manual.
- CAD-CAM interface available.

Ability Systems

Corporation, 1422 Arnold Ave.
Roslyn, PA 19001 (215) 657-4338
FAX: (215) 657-7815

Inquiry 719.

FREE TECHNICAL REPORT!

Just request info about the

"CAD/CAM Developer's Kit" Series

C Libraries for CAD/CAM, Engineering and GIS Applications
650+ routines for DXF input/output, graphical display, line/arc/ellipse/NURB spline construction/editing, and much more than can be described here.

Phone or FAX (617) 899-4350 for more information.

Building Block Software, Inc.

371 Moody Street, Waltham, MA 02154

Inquiry 720.

CD-ROM/COLLECTIBLES

PRAVDA ON CD-ROM

PRAVDA is no more but you can obtain the 1987 edition on CD ROM. English translated articles from the birth of Russian democracy. See the maneuvering that began in 1987. Only one of a kind, a real buy at \$49.00+ S/H.

Islo Tech Inc.

1-800-722-9724 (Voice)
612-934-2824 (Fax)

Inquiry 721.

CD-ROM/DESKTOP

12000 DOVER CLIP ART IMAGES ON CD-ROM

- All are bitmaps scanned at 300 dpi. 100's also in Post Script (AI) format.
- Search/Retrieve software for DOS, WINDOWS and Macintosh.
- Sampler floppys available @ \$4.00 each plus S/H.
- Call our BBS at 612-934-4775 to download a great demo.
- \$299.00 plus S/H (2.5 cents/image).

Islo Tech Inc.

800-722-9724

Inquiry 722.

CD-ROM/ENGINEERING

ADA RESOURCES ON CD-ROM

- Compilers, Source Code, Tutor, Language Reference Manual.
- Fully validated implementation of the Ada programming language.
- 75+ megabytes of Whitesands Ada Repository Software.
- 286/386 or 386-only compilers available.
- Call our BBS to download a detailed demo of the product.

Islo Tech Inc.

800-722-9724 (Voice)
612-934-2824 (Fax)
612-934-4775 (bbs)

Inquiry 723.

COMMUNICATIONS

SDLC, HDLC AND X.25 SUPPORT

Use Sangoma hardware and software to provide cost effective, robust and easy-to-use SDLC, HDLC and X.25 links from MS-DOS, UNIX, PC-MOS, etc.

All real time communication functions performed by intelligent co-processor card.

Full function SNA emulation packages also available.

Sangoma Technologies Inc.

(416) 474-1990 1-800-388-2475

Inquiry 724.

COMMUNICATIONS

3780 / BISYNC

Emulation software for DOS, UNIX & Windows. OS/2 Coming Soon! Perfect for POS, RJE, EDI, EFT, etc. Linkable API, Script, or Menu-Driven Interface.

End-Users • ISVs • VARs • OEMs

CALL (800) 634-3122 TODAY!

Inquiry 725.

THE CONNECTION MANAGER FOR LANS

Serial Port/Modem Manager—Inexpensive system for sharing communication ports among LAN workstations. LAN System Administrator can control number of modems, telephone lines, direct-connect ports, and other connection devices. Provides inbound support, conference calling support, multiple Server support (up to 16 ports/Server), topology independent-Network IPX/SPX or NetBIOS. Data rates 300 to 19200 baud. Bitcom Deluxe LAN communication package included.

The Connection Manager for IPX or NetBIOS: \$395.00

SOFTWAREHOUSE CORPORATION

326 State Street, Los Altos, CA 94022
(415) 949-0203 FAX: (415) 949-0208

Inquiry 726.

RS232 DATA ACQUISITION

Capture data from ANY serial device directly into ANY PC program—Lotus, dBASE, Excel, etc. Software makes com port act like 2nd keyboard. Many advanced features. *Supports 2-way I/O. DOS ver. \$129, Windows \$199 Fully Guaranteed!

T.A.L. - SOFTWARE WEDGE

2022 Wallace Street, Philadelphia, PA 19130
(800)-722-6004 (215)-763-2620 Fax: 215-763-9711

Inquiry 727.

RACK MOUNT MODEMS MULTI-PORT INTERNAL MODEMS (505) 899-8393

Eliminate the clutter of individual modems in multiple channel and central site installations.

Variety of rack mount and multiple-modem enclosures. Multiple channel internal modems, Multiport serial cards, State driven and multitasking communication tools for ASM, "C", BASIC. Serial data communication analysis software.

VENTANA TRANSACTION SERVICES, INC.

3301-R Coors Road NW, Albuquerque, NM 87120

Inquiry 728.

COMPUTER INSURANCE

INSURES YOUR COMPUTER

SAFEWARE Computerowners coverage provides replacement of hardware, media and purchased software. As little as \$49 a year covers accidents, theft, power surges and more. One call does it all. Call 8 am-10 pm ET. (Sat. 9 to 5)

TOLL FREE 1-800-848-3469

(Local 614-262-0550)

SAFEWARE, The Insurance Agency Inc.

Inquiry 729.

COMPUTER SYSTEMS

MULTIPROCESSOR BASED SYSTEMS

OS \$50 up; Lan/Wan Batch job Qing & Scheduling \$99, Remote Control \$50 up. Multi-PC's: e.g. 486-33-\$999, 386-33-\$699, 286-20-\$365; (case + 1Meg + 1.44FD/IDE + IO). Components: Multiprocessor, Transputer & accelerator cards, Svga, Hd, Ram, MultiPC housing, switches & cables, etc. Apps: Neural Nets, Distributed Apps., AI. Your single source for Lan/Wan/PC multiprocessing.

MB Scientific

7432 Lake Willis Drive, Orlando, FL 32821

PH: (407) 238-1451 FAX: (407) 238-0324

Inquiry 730.

CROSS ASSEMBLERS

CROSS ASSEMBLERS

Fast, reliable with unlimited length of source code. Conditional assembly, complete set of arithmetic and logical operators. Optional listing with sorted Cross-reference Table. Price \$100.00 each.

SIMULATOR-DEBUGGERS/DISASSEMBLERS

We offer excellent full-function simulators with built-in disassemblers for the 8048/49, 8051/52, 8080/85, and Z80 controllers, and now for the 8096 and 80C196, with their unique features fully supported. Prices from \$200 to \$300 each, with \$50.00 discounts for XASM + SIM packages.

Lear Com Company

2440 Kipling St., Ste. 206, Lakewood CO 80215
(303) 232-2226 FAX (303) 232-8721

Inquiry 731.

4-BAR SYNTHESIS FOR THE PC

Introducing Lear Links, Version 2.0, the fantastic linkages design package for the PC environment. The software works in any MS-DOS machine with EGA display and 512K minimum memory. You can specify 3 and 4 precision-point problems and have the program present you with thousands of possible solutions as Solution Maps with "Good" and "Bad" linkages regions from which you may choose any one and fully analyze its kinematic characteristics. You may also animate the linkage, add driving dyads, draw background geometry, and many other features. This is a must package for mechanical designers. Price: \$1250.00; interactive Demo: \$25.00

Lear Com Company

2440 Kipling St., Ste. 206, Lakewood, CO 80215
(303) 232-2226 FAX (303) 232-8721

Inquiry 732.

CROSS DISASSEMBLERS

PROFESSIONAL DEVELOPMENT SOFTWARE ASSEMBLERS/DISASSEMBLERS

8051, 8048, 8096, 8080/85, Z80/180,
Z8000, SPARC, 6800, 6809, 68HC11, 680X0,
6502/C02, 6301, 9900

COMPLETE, OPTIMIZED DEVELOPMENT TOOL SETS
FOR THE ENGINEERING PROFESSIONAL

CALL (408) 773-8465

LOGISOFT

PO BOX 61929, SUNNYVALE CA 94086
FAX: (408) 773-8466

Inquiry 733.

DATA RECOVERY

Lst yr dta? We can find it.

- 95% success rate • Fast turn around
- Priority service available • Clean room
- Servicing Novell, DOS, Macintosh, SyQuest and removable media, Unix, Xenix, OS/2, Banyan Vines, Bernoulli, Sun and more!

ONTRACK DATA RECOVERY, INC.

6321 Bury Drive, Eden Prairie, MN 55346
1-800-872-2599 • 612-937-5161

Inquiry 734.

Now we're ONTRACK in London Too.

ONTRACK DATA RECOVERY EUROPE, LTD.

Surrey House, 34 Eden St., Kingston upon Thames, Surrey KT1 1ER U.K.
0800-24-39-96 • 44-81-549-3444

Inquiry 735.

DATA/DISK CONVERSION

CONVERTING YOUR DISKETTES? ENTRUST THEM TO US!

2500 Word Processor & Computer formats,
3 1/2", 5 1/4", 8" Disks, Mag Tapes, Mag Cards, Cartridges,
Cassettes & 8 MM Custom Conversions, Programming
& Applications Development

DISK DUPLICATION OCR SCANNING SERVICES

Call us for Quality, Best Prices and Quickest Turnaround Time.

COMPANY COMPENDIA, INC., 55 E. Washington St.,
#237, Chicago, IL 60602 TEL: 1-800-374-DISK FAX: 312-419-1390

Inquiry 736.

DATA/DISK CONVERSION

THE #1 CHOICE

in disk & tape conversion

for many leading corporations, government agencies, law firms, and companies in every industry—world-wide.

Free test • Satisfaction guaranteed

Graphics Unlimited Inc.

3000 Second St. North, Minneapolis, MN 55411
(612) 588-7571 FAX: (612) 588-8783
1-800-745-7571

Inquiry 737.

QUALITY CONVERSIONS

to or from virtually

ANY TAPE OR DISK FORMAT!

Horan Data Services converts and translates data to/from 9-TRACK TAPE, 3480, 8MM & 1/2" CARTRIDGES AND ALL SIZES & DENSITIES OF DISKETTES.

Thousands of formats supported including EBCDIC, ASCII, databases, dedicated and PC word processors and typesetters.

Call 1-800-677-8885

Hours 8:00 AM to 5:30 PM Eastern Time
817 Main Street, Third Floor, Cincinnati OH 45202

Inquiry 738.

IBM PC ⇄ TO ⇄ HP FILE COPY FASTER EASIER TO USE

Update version uses windows: Call for free demo! IBM PC <to> HP File Copy allows IBM PCs, PS/2, compatibles to interchange files with Hewlett-Packard Series 70, 80, 200, 300, 1000, 9000s.

Oswego Software

Box 310 Oswego, IL 60543 708/554-3567
FAX 708/554-3573

Inquiry 739.

CONVERSION SERVICES

Convert any 9-track magnetic tape to or from over 3000 formats including 3 1/2", 5 1/4", 8" disk formats & word processors. Disk-to-disk conversions also available. Call for more info. Introducing OCR Scanning Services.

Pivar Computing Services, Inc.

165 Arlington Hgts. Rd., Dept #B
Buffalo Grove, IL 60089 (800) Convert

Inquiry 740.

DIAGNOSTIC

POTENT WEAPON Against Dead PCs!

Top-rated PocketPOST Power-On Self-Test Card with diagnostic software for ISA/EISA/Micro-channel. 180-page book. Hones your troubleshooting skills. **CALL NOW. 10% discount on phone orders!**

DATA DEPOT INC.

1710 Drew Street #5, Clearwater, FL 34615
813-446-3402 FAX 813-443-4377

Inquiry 741.

DISK DRIVES

IBM PS/2 HARD DRIVES

30MB	MOD 30, 30-286	\$350
30MB	MOD 50Z, 555X	450
60MB	MOD 50Z, 555X, 70	695
120MB	MOD 50Z, 555X, 70	795

New, genuine Big Blue Product with 1 yr. Warranty. Call for Model 60/80 drives. Terms: COD/MC/Visa

COMPUTER TECHNIQUES

Merritt Island, FL 32953-3484
Phone/Fax (407) 453-8783

Inquiry 742.

DISK EMULATION

New SRAM Disk Emulator

4 to 64Mbytes • No MOVING PARTS •
NO SOCKETS • ROBUST • RELIABLE • FAST
All SMT • Non-Volatile
Fits ATISA bus • DOS compatible
No external software required. From \$1590.

BUSINESS MACHINE INTERFACES INC.
1-800-663-4605 (USA)
(416) 756-9477 FAX (416) 756-4118

Inquiry 743.

EDUCATION

B.S. & M.S. In COMPUTER SCIENCE

The American Institute for Computer Sciences offers an in-depth correspondence program to earn your Bachelor of Science and Master of Science degrees in Computer Science at home. B.S. subjects covered are: MS/DOS, BASIC, PASCAL, C, Data File Processing, Data Structures & Operating systems. M.S. program includes subjects in Software Engineering and Artificial Intelligence.

AMERICAN INST. for COMPUTER SCIENCES
2101-BY Magnolia Ave. South, Ste. 200, Birmingham, AL 35205
800-767-2427 205-323-6191

ENTERTAINMENT

DESKTOP MODEL RAILROADING

Lay out some track! Design with precision CAD tools including ruler, grid, zoom, unique auto-curve tool. Sketch some scenery! Use color art tools to draw trees, structures, rivers, labels, logos.
Run some trains! Make custom trains, operate switches, speed controls, uncouplers, waybills, loads. Watch for tunnels, bridges, crashes.

Design Your Own Railroad \$59.95
Abacadata

PO Box 2440, Eugene, OR 97402
To order or request free catalog: (800) 451-4871
Inquiries: (503) 342-3030 FAX (503) 683-1925

Inquiry 744.

Go, NEMESIS, Go

Go - a Zen game. So appealing, it has endured 4,000 years. So useful governments study it.

NEMESIS Go Junior entices novices of any age.
NEMESIS Go Master Deluxe satiates the addicted.
Windows, Macintosh and DOS versions available.

Chaos Manor User's Choice Award (BYTE/1990)

Toyogo, Inc. (800) 869-6469
PO Box 25460-Y, Honolulu, HI 96825-0460
(808) 396-5526 fax: (808) 396-4126

Inquiry 745.

FLOW CHARTS

Have you seen the latest breakthrough in software diagramming?

ADS Diagrammer is a Microsoft windows 3.0 drawing tool that allows you to create complex software diagrams faster and more easily than ever before!
Call for your free trial disk today!

\$250 Atlantic Design Systems

77 Sprucewood Dr., Gifford, NH 03246
Phone: (800) 745-6095 or (603) 524-2943
Fax: (603) 524-3657

Inquiry 746.

WINDOWS FLOWCHARTER \$129

RFFlow 2.0 is a professional drawing tool for flowcharts & org. charts. Requires Microsoft Windows 3.0. 100 shapes auto adjust in size. Diagonal lines and curves. Auto line routing and re-routing. Click on a shape to bring up a sub-chart. Move charts to other apps. via the Clipboard. Call for free trial disk.

RFF ELECTRONICS

1053 Banyan Court, Loveland, CO 80538
Phone: (303) 663-5767 FAX: (303) 669-4889

G.I.S.

Digital Base Maps

Local Street Maps, State Maps, and World Maps for AutoCAD™, MicroStation™, Atlas★GIS, MapInfo™, or DXF™, Gigabytes of Map Data available!

Micro Map & CAD
(303) 988-4940

Inquiry 747.

HARD DRIVE REPAIR

Pre-Owned Electronics, Inc™

THE Independent Provider, serving the Dealer, Professional, Corporate, Government, and Educational Buyer since 1985

APPLE® II & MACINTOSH® SYSTEMS • PARTS • EXCHANGE REPAIRS

Call for a Catalog... **800-274-5343**
INT'L: 617-275-4600 • FAX: 617-275-4848
205 BURLINGTON ROAD • BEDFORD, MA 01730

Inquiry 748.

HARDWARE

MYLEX MOTHERBOARDS

386	33MHz, 64K IDE, 2SP&PP	\$ 595
386sx	20MHz, IDE, 2SP&PP	349
486	50/33MHz, 64k cache (baby) ISA	1195/895
486	50/33MHz, 128k, EISA	1995/1495
GXE 020 B	EISA/TIGA Graphics Adapter	1179
DCE 376	EISA/SCSI Adapter	695
LNE 390	Network Interface for EISA 32-Bit	325

2 Year Warranty Factory Service

EXALINX, Inc.

Beautiful Buffalo, New York USA
(800) 992-5469 FAX (716) 882-9650

Inquiry 749.

MAINFRAME POWER Microcomputer Price!

- Multi-Task
- REAL DOS
- Unlimited Users*
- NOVELL Compatible

A TRUE 32 BIT O/S

- Software only, or complete Hard Drive Setup (new)
- Complete setup with utilities, DOS & DOS files, menu & system manual.
- Chance to win one! 1-900-420-3709 ext.837 (\$10 per call free demo sent)

OCTOPUS SYSTEMS Inc.

"Many DOS arms to serve you"
404-448-4980 FAX: 404-448-5032

Inquiry 750.

HARDWARE/COMPUTERS

SC/FOX™ EMBEDDED COMPUTERS

PC Parallel Coprocessor Plug-in Boards: 15 MIPS avg 50 MIPS burst, using the SC32 32-bit CPU or the 16-bit Harris RTX 2000™

VME Master/Slave System Controller SBC: 18 MIPS avg 70 MIPS burst, uses RTX 2000 cpu, SCSI, 2 ser, 1 ptr ports, to 640K bytes.

Stand-Alone Single Board Computers: 18 MIPS avg 60 MIPS burst, 3U or 100x100mm Eurocard-size using either SC32 or RTX 2000.

Ideal for embedded real-time control, data acquisition, robotics, and signal processing. OEM software development system included.

SILICON COMPOSERS INC (415) 322-8763
208 California Avenue, Palo Alto, CA 94306

Inquiry 751.

SDK-386™*

*386 is a trademark of Intel Corporation. Used by permission
BRAND NEW AND AVAILABLE ONLY FROM URDA, INC. along with the URDA SDK-85 and SDK-86 educational trainers and microprocessor development systems. The URDA SDK-51 will be available next year. Other 8, 16, and 32 bit systems are available.

Phone URDA, Inc.

1-800-338-0517 or 412-683-8732

Inquiry 752.

HARDWARE/COPROCESSOR

DIGITAL SIGNAL PROCESSOR

DSP products for the IBM PC AT. Our TMS320C25 and TMS320C51 based boards, with extensive software, feature 250 Khz multi-channel A/D and D/A, up to 192 Kwords RAM, very high throughput to PC RAM and disk, and are priced competitively with traditional Analog IO boards. Call us about your applications.

DALANCO SPRY

89 Westland Ave., Rochester, NY 14618
Ph/FAX (716) 473-3610

Inquiry 753.

LANs

The \$25 Network

Try the 1st truly low-cost LAN

- Connect 2 or 3 PCs, XT's, AT's
- Uses serial ports and 5-wire cable
- Runs at 115K baud
- Runs in background, totally transparent
- Share any device, any file, any time
- Needs only 14K of RAM

Skeptical? We make believers!

Information Modes

P.O. Drawe, F. Denton, TX 76202
817-387-3339 Orders 800-628-7992

Inquiry 754.

LANs/SOFTWARE

NetRunner/FreeLAN NOS

The most reliable and lowest cost LAN software

NetRunner: Remote Control, Remote Printing, File Transfer, Remote Execution. Runs on NetBIOS, Novell, and Modem/RS-232. Starter Kit \$24.95. Unlimited: \$99.95.
FreeLAN NOS: File Sharing, Printer Sharing, File/Record Locking, Printer Spooling, NetBIOS based, non-dedicate solution. Runs on Ethernets, Arcnets, and Serial Ports. Starter Kit: \$39.95. Unlimited: \$149.95.

Crystal Computing Corporation

P.O. Box 9527, San Jose CA 95157-0527
Tel (800) 726-6209 (408) 446-1522 Fax: (408) 996-2899

Inquiry 755.

LAPTOP COMPUTERS

SAVE! LAPTOPS * NOTEBOOKS SAVE!

TOSHIBA • EVEREX • ZENITH • AT & T • TANDON

AST • SHARP • BONDWELL • ALR • LIBREX

PANASONIC • ALTIMA • LEADING EDGE

PACKARD BELL • SAMSUNG • NEC • TI • COMPAQ

• We ALSO carry accessories and software •

Computer Options Unlimited

12 Maiden Lane, Bound Brook, NJ 08805

CALL: (800) 424-7678 Need Help?: 908-469-7959

9-9 M-F 9-5 Sat. 6 days Worldwide Sales

Inquiry 756.

IBM CONVERTIBLE

MEMORY-128K \$79 256K \$225

MODEMS-Standard \$75 Enhanced \$175

CRT ADAPTER-for monitors \$99

SERIAL/PARALLEL ADAPTER-\$120

MONITORS-Monochrome \$59 Color \$109

COMPACT Carrying Case \$39

ENHANCED LCD-\$79 BATTERY-\$98

HARD DRIVES-20 Meg-\$495 40 Meg-\$695

MORE ACCESSORIES AVAILABLE

COMPUTER RESET

P.O. Box 461782, Garland, TX 75046

Phone (214) 276-8072 BBS & FAX (214) 272-7920

Inquiry 757.

LAPTOP PERIPHERALS

NEW LOW PRICES ON:

- Battery Powered Printers
- Portable Hard Drives
- Laptop Expansion Systems
- Backlites AND MORE!

Call for free catalog

AXONIX CORPORATION

(800) 866-9797

Inquiry 758.

LAPTOP PERIPHERALS

ACOUSTIC ADAPTERS NEW 9600 bps

- World Wide Data Connection
- To 9600 bps error free (w. V.32/V.42 modem)
- For Executives, Journalists, Sales Professionals
- RJ-11 Modem Connection
- Self Test, Auto On/Off
- Smallest, Most Adaptable, Made in USA
- Call for lowest price in the industry

Information Machines

Woodland Hills, CA

(818) 884-5779 FAX: 818-884-5853

Inquiry 759.

MULTI-MEDIA

UPGRADE KITS

MEDIA VISION KIT (\$799)—Pro Audio Spectrum Card, Int. Sony Cd Drive, Compton's Encyc. Cd, Jones in The Fast Lane Cd and MS Windows W/Multimedia On Cd. **SOUND BLASTER KIT** (\$679)—Sound Blaster Pro Card, Int. Panasonic Cd Drive, and 5 Cd Titles.

Other Kits And Cd Titles Available
Call for Prices and FREE INFO.

Computech Computer Services

9254 S.W. 38 Street, Miami, FL 33165 (305) 861-2723

Inquiry 760.

PRINTER UTILITY

NO MORE PAPER SWAPPING

Merge text and PCX files for output on a HP LaserJet or compatible with **FormPrinter 1.0**. Run from DOS or integrate into your app. Preload images in printer memory for increased throughput. Include Code 39 bar codes using escape sequences in the text file. Create the PCX files with the editor of your choice. Fully configurable. EXE \$79.00. With source code (MS-C & MASM) \$109.00

TLC TECHNOLOGY

1831 Wells Branch Pkwy, Suite 222, Austin, TX 78728
(512) 795-3403

Inquiry 761.

PROGRAMMERS TOOLS

C and C++ DOCUMENTATION TOOLS

- **C-CALL** (\$69) Graphic-tree of caller/called hierarchy.
- **C-CMIT** (\$69) Generate, insert, update comment-blocks.
- **C-METRIC** (\$59) Path complexity, lines/stmts/comments.
- **C-LIST** (\$69) List, action-diagram, reformat programs.
- **C-REF** (\$59) Local/global/parameter cross-references.
- **C-DOC** (\$199) All 5 as 1 DOS program. <=15,000 lines.
- **Professional** (\$299) <=150,000 lines, DOS, OS/2, Windows.

SOFTWARE BLACKSMITHS INC.

6064 St. Ives Way, Mississauga, ONT, Canada L5N-4M1
(416) 858-4466

Inquiry 762.

Boost Your BASIC!

ProBas adds 938 new commands to QB and PDS. Written in assembly for blinding speed, ProBas makes your programs fast and professional looking! Easy to use, money-back guarantee. Nine other add-ons for BASIC and Visual Basic available—call for your FREE copy of "10 Easy ways To Boost Your BASIC".

TeraTech (800) 447-9120 x111

Dept 86B, Suite 360, 3 Choke Cherry Rd., Rockville, MD 20850
(301) 330-6764 Fax (301) 963-0436

Inquiry 763.

ROM BIOS UPGRADES

AMI, PHOENIX & MR BIOS

Upgrade your IBM PC, XT, AT or compatible. Also 386SX & 386 versions. Supports 2 user-defined hard drives, 101/102 KB, 360, 720, 1.2 & 1.44 floppies, setup in ROM. All Video, Windows 3.0 Diagnostic in ROM AMI 286 & 386 versions only. CALL. New version just came in.

Advanced Software

8 Stiles Road, #1A, Salem, NH 03079
800-835-2467 603-898-2362
Fax: 603-890-1185

Inquiry 764.

SECURITY

FIGHT PIRACY!

- ★ EVERLOCK 3.0 ★
- SOFTWARE COPY PROTECTION
- New Option Board Safe-New Remote Registration
- New CPU LOCK-CD ROM LOCK and more
- ★ EVERKEY HARDWARE LOCKS ★

Az-Tech Software, Inc.

201 East Franklin, Richmond, MD 64085

Call for a

FREE Demo (800) 227-0644

(816) 776-2700
FAX (816) 776-8398

Inquiry 765.

THE ULTIMATE COPY PROTECTION

- Completely menu driven
- Defeats all Hardware/Software Copiers
- No Source Code Changes
- Multiple Layering
- No Damaged Media
- Full Hard Disk & LAN Support
- Unlimited Metering, FREE Demo Disk

Quite Simply

The Best

Ways To

Protect Your Valuable

Software Investment

STOPVIEW™ STOPCOPY PLUS™ (800) 879-2224

BBI COMPUTER SYSTEMS, INC. (301) 871-1094

14105 Heritage Lane, Silver Spring, MD 20906

FAX: (301) 460-7545

Inquiry 766.

Cop's CopyLock II

The professional software protection with TRUE Machine Install. Option Board safe. Supports OS/2, Windows and Trace.

LINK Computer

Int'l: + 45 31232350 Fax: + 45 31238448

US/CAN: 800-344-2545 FAX: 408-923-7061

BIT-LOCK® SECURITY

Piracy SURVIVAL 8 YEARS proves effectiveness of powerful multilayered security. Rapid decryption algorithms. PARALLEL or SERIAL port-transparent security device. Complemented by economical KEY-LOCK™ and multifunctioned COMPU-LOCK™ including countdown, timeout, data encryption, and multiproduct protection. (Dos/Unix/Mac). Also, access control.

MICROCOMPUTER APPLICATIONS

3167 E. Otero Circle, Littleton, CO 80122

(303) 770-1917

Inquiry 767.

OPEN SYSTEMS ?

Technical Crime is both Profitable and Low Risk AM/CrySys™ gives you the Banking Industry Solution

- ◊ US Govt. Approved Methods
- ◊ External & Internal Keys
- ◊ Protect, Authenticate Data
- ◊ Multiple Interlocked Arming
- ◊ Max. Performance, Min. Memory
- ◊ Key Manager and Distributor
- ◊ Files, Bases, Media, Messages
- ◊ Interfaces and Utilities

N L I Systems Inc.

PO Box 103, 5051 Nesstun, NORWAY

Int'l: +47 510 5620 Fax: +47 510 5621

Inquiry 768.

SHAREWARE

THE AMISH OUTLAW

SHAREWARE COMPANY

***** FREE *****
WITH EVERY ORDER YOU WILL RECEIVE A GREAT NEW GAME NOT LISTED IN OUR CATALOG ABSOLUTELY FREE

ALL DISKS HAVE EASY-TO-USE MENUS
SIMPLY TYPE "GO" TO ACCESS PROGRAMS
\$3.00 PER DISK 1-9 - \$2.50 PER DISK 10-UP
3.5" AND 5.25" DISKS SAME PRICE
(IBM PUBLIC DOMAIN AND SHAREWARE ONLY)
3705 RICHMOND AVE., STATEN ISLAND, NY 10312
1-(800) 947-4346 or (718) 317-0198 FAX 1-(718) 966-4766

Inquiry 769.

SHAREWARE

FREE SOFTWARE for IBM®

TRY US! GET 15/5.25" or 8/3.5" Disks full of our best selling software—FREE. Games, Windows® clip art, fonts, utilities, business, educational, desktop publishing, religion, home/health. Pay only \$5.00 shipping/handling. Credit cards only. Call Today!

SMC SOFTWARE PUBLISHERS 619-931-8111 ext. 511

Inquiry 770.

SOFTWARE/ACCOUNTING

dBASE BUSINESS TOOLS

- GENERAL LEDGER
- ORDER ENTRY
- JOB COSTING
- BILL OF MATLS
- PAYROLL
- PURCH ORD/INVENTORY
- ACCOUNTS RECEVABLE
- JOB ESTIMATING
- SALES ANALYSIS
- ACCOUNTS PAYABLE

\$99/\$198 ea. + S&H

DATAMAR SYSTEMS Cred. Card-Check-COD

8586 Miramar Place, San Diego, CA 92121

(619) 452-0044 (800) 223-9963

Inquiry 771.

SOFTWARE/BUSINESS

DATA ENTRY SOFTWARE

Full featured, heads-down data entry with two-pass verification, edit language, operator stats, much more! Designed for the PS/2®, PC, XT, AT or compatibles.

PCs from \$395 LAN version available

FREE 30 day trial

Computer Keys Tel: 206/776/6443
21929 Makah Rd., Fax: 206/776-7210
Woodway, WA 98020 USA: 800/356-0203

SOFTWARE/ENGINEERING

Analog & Digital

Circuit Design & Simulation

for Windows™ & the Macintosh™

B² Spice® \$130/ea. B² Logic®

MOSFET BJT, JFET & others. Over 100 components.
Transient, Ac, DC analyses. Interactive and batch simulations.
Graphs & tabulates results. View results in timing diagrams.

Graphical Schematic Entry

• Now in use at over 20 major universities •

Beige Bag Software Ph: (313) 663-4309
715 Barclay, Ann Arbor, MI 48105 Fax: (313) 663-0725

Inquiry 772.

Analog Circuit Simulation

- PC and Macintosh CAE
- Schematic Entry
- SPICE Simulation
- Monte Carlo Analysis
- Parameter Sweeping
- Filter Design
- Extensive Model Libraries
- Waveform Analysis
- Report-Quality Plotting
- Full SPICE programs starting at \$95. Complete systems from \$990

P.O. Box 710, San Pedro, Ca 90733-0710

310-833-0710, FAX: 310-833-9658

Call for your Free Demo and information kit

intusoft

Inquiry 773.

Worstcase Gets Even Better!

ECA-2 Analog Circuit Simulator

Offers the best Monte Carlo and Worst-Case Analyses

- Interactive/batch modes • Full Nonlinear Simulator
- On-line, Real-Time Graphics • Multiple Plots
- AC, DC, Transient, Fourier, Temperature
- AC & DC Sensitivity • Component Sweeping
- ALL included with TWICE the speed at HALF the cost!

Tatum Labs, Inc.

P.O. Box 1263, Ann Arbor, MI 48106-1263

(313) 663-8810

Inquiry 774.

SOFTWARE/GRAPHICS

TIFF, PCX, TARGA, GIF, DIB, BMP, WMF, WPG
AccuSoft Image Format Library
 Import, export, convert, display and print images. DOS & Windows versions included in one low priced, royalty free package. Sample applications with complete source code. Compatible with all major C, C++ compilers and all Windows languages. Supports all flavors of each format up to 24 bits/pixel. 30 day satisfaction guarantee. \$295

AccuSoft Corporation

160 E. Main St., Westboro, MA 01581
 (800) 525-3577 (508) 898-2770 FAX (508) 898-9662

Inquiry 775.

SUPER VGA GRAPHICS LIBRARY

for video boards using Tseng Labs ET4000 chip. Over 60 routines callable from MS FORTRAN. Up to 1024x768x256 colors with 1MB video memory. 2-D & 3-D w/perspective. Flat & Gouraud shaded polygons. Mouse & joystick support. Scale and rotate text. Store/retrieve in PCX format. \$100 postpaid. Demo \$10, refunded w/purchase. Specify 5.25" or 3.5" diskette.

AEROSOFT CORPORATION

5562 Bells Ferry Rd., Suite 233, Acworth, GA 30101
 (404) 917-1309

Inquiry 776.

TG-Professional v. 4.0

"The Ultimate CAD/CAM/CAE Graphics Engine"
TG-PROFESSIONAL, the most complete C/C++ toolbox of 2D & 3D geometric routines available today! Over 800 routines including NURBS, DXF, Graphics, Surfacing, Hidden Line, Volumes, Areas, Transforms, Perspectives, Polygon (In/Un/Out/Dir), Clipping, Tangents. A utilities library with Graphics routines for drawing using BGI or MSC Graphics and more. Full source. 30 day guarantee. USA \$500.00, Foreign \$565.00US. Technical information available.

Disk Software Inc.

2116 E. Arapaho Rd., Suite 487, Richardson, TX USA 75081
 Phone: 214-423-7288 • 800-635-7760 • FAX: 214-423-7288

Inquiry 777.

RAINDROP™

FAST, compact PrtScr Utility for end users AND developers. Hardcopy as fast as 10 secs. Average binary size - 8 kbyte. 14 video graphic standards. Scale, rotate, colorize and more. "CALL" from user-written programs. Complete 9- & 24-pin dot-matrix, inkjet, and laserjet library \$44.95 + \$3 s/h.

ECLECTIC SYSTEMS

8106 St. David Ct., Springfield, VA 22153
 (703) 440-0064 Fax (703) 455-8965

Inquiry 778.

FORTRAN GRAPHICS

GRAFATIC - FORTRAN callable graphics Library for creating 2-D and 3-D graphics, contour plots and solid models. PRINTMATIC and PLOTMATIC provide high resolution FORTRAN callable printer and plotter drivers for your graphics. NO ROYALTIES. \$249.95 ea.

Supports Microsoft/Lahay/RM FORTRAN compilers

Jewell Technologies, Inc.

130 Nickerson St., Suite 105, Seattle, WA 98109
 1 (800) 284-2574 (206) 285-6860

Inquiry 779.

SOFTWARE/MATHEMATICS

Mathematical Modeling On Your PC

Science Engineering Business

- Faster, Easier, more Powerful than other methods
- Nonlinear Algebraic and Differential Systems
- Solve For Any Parameter Values • No Programming
- Complex • Vectors • Natural Mathematics Editor
- Simulation • Optimization • Graphics

New Chico Solver 2.3 (916) 342-3279 Only \$399
 Full refund for 30 days if not satisfied. VISA/MC/PO#
 Chico Software Company PO Box 5174, Chico, CA 95927

Inquiry 780.

SOFTWARE/PACKAGING

FREE SOFTWARE PACKAGING CATALOG

Everything you will need to Package, Distribute, and Ship Your Software! From manuals and binders to mailers and shippers.

LABELS • LABELS • LABELS

For your diskettes, plain or custom printed dot matrix or laser printer... free samples

FREE CATALOG

Hice & Associates

8586 Monticello Dr., West Chester, OH 45069
 Phone/Fax: 513-777-8586

Inquiry 781.

SOFTWARE/SCIENTIFIC

Weather Monitor & Weatherlink!

The ultimate in weather monitoring systems! A state-of-the-art weather station and a PC link allow you to view, record, summarize, and graph weather information. The perfect marriage of computer and weather technology.

DAVIS INSTRUMENTS

3465 Diablo Avenue, Hayward, CA 94545
 1-800-678-3669 • FAX 1-510-670-0589

BT18

Inquiry 782.

SOFTWARE/SORT

OPT-TECH SORT/MERGE

Extremely fast Sort/Merge/Select utility. Run as an MS-DOS command or CALL as a subroutine. Supports most languages and file types including Btrieve and dBASE. Unlimited file sizes, multiple keys and much more! MS-DOS \$149. OS/2, XENIX, UNIX \$249.

(702) 588-3737

Opt-Tech Data Processing

P.O. Box 678 - Zephyr Cove, NV 89448

Inquiry 783.

SOFTWARE/VOICE/FAX

MULTI-VOICE® TOOLS

Multi-Voice Tools is a complete development Toolkit for Pascal or "C" to access all the features for most speech processing boards available today. It helps you write MULTI-LINE VOICE APPLICATION systems in minutes. A number of programming examples are provided. All programs and libraries are delivered with source code.

Dialogic, Rhetorex, Pika, VBX: \$599. Watson (Single Line): \$99. ALSO AVAILABLE: Fax Programmer's Toolkit (\$199). Based on CAS specifications. Visa/MC accepted.

ITI Logiciel

4263 Cristophe-Colomb, Montreal, Quebec, Can. H2J 3G2
 TEL (514) 597-1692 FAX (514) 526-2362

STATISTICS

VISUALIZE YOUR DATA

MCA+ transforms most marketing and social science data to easily understood perceptual maps. Communicate complex relations with ease using presentation quality charts. Most printers supported. Demos available.

Bretton-Clark

89 Headquarters Plaza, Morristown, NJ 07960
 (201) 993-3135 FAX: (201) 993-1757

Inquiry 784.

NCCSS 5.x Series - \$125

Easy-to-use menus & spread sheet. Multiple regression. T-tests. ANOVA (up to 10 factors, rep. measures, covariance). Forecasting. Factor, cluster, & discriminant analysis. Nonparametrics. Cross Tabulation. Graphics: histograms, box, scatter, etc. Reads ASCII/Lotus. Many new add-on modules.

NCSS

329 North 1000 East, Kaysville, UT 84037
 Phone: 801-546-0445 Fax: 801-546-3907

Inquiry 785.

TRANSLATION

SOFTWARE LOCALIZATION

Since 1980, IDOC has translated hundreds of packages for the world's most prominent computer firms: Ashton-Tate, Borland, HP, Sun Microsystems, Novell and many more. We offer FULL SOFTWARE ADAPTATION WITH IN-HOUSE ENGINEERING. TRANSLATION INTO ALL MAJOR LANGUAGES WITH IN-HOUSE LINGUISTS, DTP SPECIALISTS, AND EDITORS. With production and sales offices in Los Angeles, Dublin, Milan, Buenos Aires, and Tokyo (Fall '92). IDOC is the leader in worldwide translation services.

IDOC, an International Documentation Company

1-800-336-9898 (U.S.) 351-1-284-4223 (Europe)
 10474 Santa Monica Blvd, Suite 404, Los Angeles, CA 90025

Inquiry 786.

UPS

ELIMINATE LAN DOWNTIME AND DATA LOSS

APC protects more LANs than any other brand of UPS. Call for your FREE power protection handbook detailing:

- Smart-UPS high-performance protection, PC Magazine's Editors' Choice
- Back-UPS cost-effective protection starting at \$169
- PowerChute automatic shutdown software for all major OS
- SurgeArrest network grade surge protection

"Our highest marks go to the Smart-UPS 900" BYTE 5/91

American Power Conversion APC Europe
 132 Fairgrounds Road 4 Rue St. Claire DeVillegne
 West Kingston, RI 02892 77447 Marne la Vallee Cedex 2,
 800-541-8896 FRANCE (+33) 160178400
 Fax: (+33) 160178029

Inquiry 787.

UTILITIES

MEMORY MANAGER ON THE FLY

Dynamic Memory Control automatically loads and unloads TSRs and device drivers without having to reboot. Eliminate multiple CONFIG/AUTOEXEC files. Converts TSRs and drivers to self-removing programs. Order from: The Connection #49 1-800-336-1166.

Adlersparre & Associates Inc.

501-1803 Douglas St., Victoria, BC V8T 5C3
 Tel: (604) 384-1118 Fax: (604) 384-3363

Inquiry 788.

Sorry, Anti-Virus Software

Compare anti-virus software and the *VirusStop PC Immunizer Card*

	VirusStop	Leading Software
Occupies Ram	NO	YES
Needs constant updates	NO	YES
Vulnerable to virus infection	NO	YES
Take time to scan drives	NO	YES
Can be deleted	NO	YES
Password Function	YES	NO
Network Compatibility	YES	Requires Special Version
Cost (\$&H extra)	\$59	\$80 and up, plus the upgrade costs

MULTIX, INC. 4203 Beltway Dr., Suite 7, Dallas TX 75244
 Tel: (214) 239-4989 Fax: (214) 239-6826 We accept MasterCard and VISA

Inquiry 789.

Why You Want BATCOM!

BATCOM is a batch file compiler that transforms your .bat files to .exe files to make them faster. BATCOM extends DOS with many new commands so you can read keyboard input, use subroutines, and much more. In addition, BATCOM protects your source code. No royalties! Only \$59.95. Order today!

Wenham Software Company

5 Burley St., Wenham, MA 01984
 (508) 774-7036

Inquiry 790.

WINDOWS

A Hypertext-like database for scanned images under MS-Windows™ 3.x

A perfect image management tool for professionals. Displays multiple windows of images and documents in true color or with color matching. Associates text info, images or symbols to any pixel inside an image. Easily switches from image to image through successive levels of detail. Finds a point inside an image by entering its name e.g. address. Organize images and files in a network/relational database. Users can design their own information templates and search with multiple keys. Include a powerful editor. Pan and zoom within images. Work with PCX and BMP file formats. Major credit card accepted.

Friendly Information Systems, Inc.

34 Bow Avenue, Dedham, MA 02026
 (508) 486-0003 or (617) 329-1620 **\$350**

Inquiry 791.



PS/2 model 55SX-60 meg	1985
PS/2 model 70-120 meg	3195
IBM model 35-40 meg	1795
PS/2 model 70-A21	4195
PS/2 model 95-320 meg	14950
*** Monitor Extra ***	



DeskPro Models

386/25M	CALL
386/33M	CALL
486/25M	CALL
486/33M	CALL
486/50L	CALL

*Call for other models - Monitor Extra *



Network 386 V.3.11

5 users	CALL
10 users	CALL
20 users	1895
100 users	CALL
250 users	CALL

**WE STOCK
TOSHIBA**

**CITIZEN
OKIDATA
EPSON**

**HITACHI
TALLGRASS
ARCHIVE**

**NEC
ALR
WYSE**

**HOUSTON INSTRUMENTS
MICROSOFT
SUMMAGRAPHIC**

**INTEL
PC MOUSE
CALCOMP**

AES Computers
All systems include

Made
in
USA

- Intel CPU
- 4 meg RAM memory expandable to 64 meg
- Desktop or tower case
- 2 serial, 1 parallel, 1 game (joystick) ports
- 101 keyboard AT enhanced keyboard
- 1.2 (5.25") & 1.44 (3.5") Teac floppy drives
- SVGA card w/1 meg & SVGA 0.28mm monitor
- MS DOS 5.0 (complete w/manuals)
- MS Windows 3.1 (complete w/manuals) & mouse

486/33 with 200 meg HD.....	2250
386/40 with 120 meg HD.....	1595
386SX/25 with 40 meg HD.....	1295

One year limited warranty



**NOVELL
Authorized
Dealer**

LAN BOARDS

8 bit Arcnet	75
16 bit Arcnet	160
Novell NE 1000	160
Novell NE 2000	175
8 port Active Hub	325
Token Ring Card	399
Tokenhub 4-port	355

Call for other
LAN Accessories

LASER PRINTERS

HP Laser IIIISi	3595
HP Laser IIID	CALL
HP Laser III	1525
HP Laser IIIP	CALL
HP IIP Plus.....	CALL
OKI OL 800	CALL
OKI OL 840 P.S.	1720
Panasonic 4400	CALL
Panasonic 4450	1295
NEC Silentwriter 2.....	CALL

PRINTERS

Epson LQ 200	245
Epson LQ 570	295
Epson LQ 870	480
Epson LQ 1170	625
OKIDATA 320.....	330
OKIDATA 390.....	465
Citizen HSP-500	335

HARD DISKS

CONNOR	
CP30104 120 meg	CALL
CP3204F 220 meg	CALL

**QUANTUM, MAXTOR,
SEAGATE**

CALL FOR ALL MODELS

BRAND NAMES LOW PRICES

**LEADER
SINCE 1983**

*We export to Europe, Asia
& the Far East*

*We Honor Manufacturer's
Warranties*

Call for details

AST NOTEBOOKS

Exec 386SX/25, 60 meg	2575
Exec 386SX/25, 80 meg	2725
Exec 386SXC/25, 60 meg, color	2895
Exec 386SXC/25, 80 meg, color	3295
Exec 386SX/25, 120 meg, color	3795

OTHER NOTEBOOKS

TI 3000, 386SX, 120 meg	CALL
Compaq LTE Lite 386SL	CALL
Toshiba 2200SX, 80 meg	CALL
Toshiba 4400SX, 80 meg	CALL
Toshiba 6400SXC, 120 meg	CALL
Toshiba 3300SL, 80 meg	CALL

Call for pricing on other brand name models



MEGACUBE ISA BUS

486-33 MHz System
8/16 meg, 128K Cache, ESDI..... **CALL**

486/33 MHz Tower

4 meg, 256K Cache, 1.2 &
200 meg drives, SVGA Combo

Step 386-33 MHz System

2 meg, 64K Cache, 1.2 & 150 meg
Drives, 1024x768 SVGA Combo

Step 386-25 MHz System

1meg, 64K Cache,
640x480 VGA Combo



AST Bravo 386SX25 model 1.....	1070
AST Bravo 386/25 model.....	2295
AST Premium 386SX20 model 1	1295
AST Premium 386/33 MDL 1	2225

INTEL COPROCESSORS

80287 XL	\$99.00
80387 SX-16	\$135.00
80387 SX-20	\$149.00
80387 DX25/33	\$205.00

Corporate Accounts
Welcome

**Call for Discounts
on Volume**

And
Consultant Orders

**Exports
Available**

Computerlane inc.

Outside California: 1-800-526-3482

Inside California: 818-884-8644 • FAX: 818-884-8253

7500 Topanga Canyon Boulevard, Canoga Park, CA 91303

Hours: Monday - Friday 9 -6, Saturday 10-6

Compaq is a Registered Trademark of Compaq. IBM is a Registered Trademark of International Business Machines.

ALL QUOTED
PRICES ARE CASH
PRICES ONLY

Visa, MasterCard
and
American Express
are higher

Prices subject to change
without notice.

*Quantities are limited

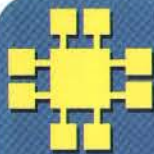

JDR Microdevices®

2233 Samaritan Drive, San Jose, CA 95124

Serving you since 1979

BUY WITH CONFIDENCE FROM JDR!

- 30-DAY MONEY BACK GUARANTEE
- 1 YEAR WARRANTY
- TOLL-FREE TECH SUPPORT



CALL FOR YOUR FREE JDR CATALOG TODAY!

FOR PC'S, SOFTWARE, MONITORS, DISK DRIVES, KEYBOARDS, MODEMS, CABLES, CONNECTORS, ICs, COMPONENTS, PROGRAMMERS, TEST EQUIPMENT, TOOLS & MORE!



16-BIT VGA CARD

- 8/16-bit 8088 or 286/386/486 compatible
- 640 x 480 in 16 colors
- 320 x 200 in 256 colors
- 256Kb video RAM

\$499⁹⁵



- MCT-VGA-16 \$49.95
- MCT-VGA-1024+ 1024x768, 512 Kb VGA card **\$149.95**
- MCT-IDEFH 16-bit IDE hard/floppy controller \$29.95
- MCT-IDEIO 16-bit IDE floppy/hard multi I/O \$69.95
- MCT-AIO Serial/parallel/game port card \$49.95
- MCT-AIO+ Two NS16550 serial/par/game port .. \$89.95
- MCT-FDC-HD 1.44Mb floppy controller \$49.95
- DFINET-400 16-bit Ethernet card \$149.95
- GATEKEEPER PC security card \$49.95
- PCODE Diagnostic display card \$49.95

1024 X 768 NON-INTERLACED VGA PACKAGE

\$499⁹⁵

- 0.28mm dot pitch non-interlaced monitor & high-resolution VGA card
- Resolution up to 1024 x 768 in 256 colors*
- 512Kb video RAM expandable to 1Mb



- VGA-PKG-1024N .. \$499.95
- VGA-PKG-1024+ 1024x768 interlaced VGA pkg. **\$469.95**
- VGA-PKG 640x480 interlaced VGA pkg. \$349.95
- VGA-MON-1024 1024x768 interlaced monitor \$349.95
- VGA-MON-1024N 1024x768 non-interlaced mon. **\$389.95**

* Note: Requires 1Mb RAM for 1024 x 768 in 256 colors

MOTHERBOARDS



20MHZ CACHE 486SX \$549

- 20MHz Intel 80486SX CPU • 64Kb cache memory on board (expandable to 256Kb) • Expandable to 32Mb on-board using 256Kb, 1Mb or 4Mb SIMMs (0Kb installed) • Includes Intel's "Vacancy" socket

- MCT-M486SX \$549.00
- MCT-M486-30 Mini-size 50MHz cache 486 **\$1495.00**
- MCT-M486-33 Mini-size 33MHz cache 486 **\$995.00**
- MCT-C386-40 Mini-size 40MHz cache 386 **\$699.00**
- MCT-C386-33 Mini-size 33MHz cache 386 **\$599.00**
- MCT-M386-25 Mini-size 25MHz 386 **\$399.95**
- MCT-M386SX-20 Mini-size 20MHz 386SX **\$299.95**
- MCT-M386SX Mini-size 16MHz 386SX **\$249.95**
- MCT-M286-16 Mini-size 16MHz 286 **\$149.95**
- MCT-M286-12 Mini-size 12MHz 286 **\$129.95**
- MCT-TURBO-10 Mini-size 10/4.77MHz 8088 .. **\$69.95**

CONNER 84Mb DRIVE PACKAGE

\$319

- CP-30084 84Mb, 19ms IDE hard drive, 16-bit floppy/hard disk controller, cables and instructions



HDKIT80 \$319

IDE HARD DRIVES

PART #	BRAND	CAP.	SPD.	TYPE	PRICE
CP-3000	Conner	42Mb	28ms	3.5" IDE	\$199
ST-351A	Seagate	42Mb	28ms	3.5" IDE	\$209
CP-30084	Conner	84Mb	19ms	3.5" IDE	\$299
ST-3096A	Seagate	88Mb	16ms	3.5" IDE	\$319
CP-30104	Conner	120Mb	19ms	3.5" IDE	\$379
ST-3144A	Seagate	131Mb	16ms	3.5" IDE	\$399
CP-3204F	Conner	212Mb	16ms	5.25" IDE	\$599

FLOPPY DRIVES

- FDD-1.44A 1.44Mb, 3.5", Beige .. **\$79.95**
- FDD-1.44X 1.44Mb, 3.5", Black .. **\$79.95**
- FDD-1.2 1.2Mb, 5.25", Beige **\$89.95**
- FDD-360 360Kb, 5.25", Black **\$79.95**



ENHANCED KEYBOARD

\$499⁹⁵



BTC-5339 101/102-key enhanced layout \$49.95

3-BUTTON MOUSE

\$149⁹⁵

- Accuracy 290-1450 DPI
- Opto-mechanical design
- Windows 3.0 compatible



JDR-MOUSE-3 \$14.95
MOUSE-PAD \$4.95

DYNAMIC RAM

PART #	SIZE	SPEED	TYPE	PRICE
41256-80	256K x 1	80ns	DIP	1.69
41256-60	256K x 1	60ns	DIP	2.39
414256-80	256K x 4	80ns	DIP	5.95
1M8-80	1M x 1	80ns	DIP	5.99
1M8-60	1M x 1	60ns	DIP	6.49
41256A98-80	256K x 9	80ns	SIMM	16.95
41256A98-60	256K x 9	60ns	SIMM	19.95
421000A98-10	1M x 9	100ns	SIMM	49.95
421000A98-80	1M x 9	80ns	SIMM	54.95
421000A98-60	1M x 9	60ns	SIMM	59.95
424000A98-80	4M x 9	80ns	SIMM	179.95
424000A98-60	4M x 9	60ns	SIMM	219.95

MATH CO-PROCESSORS



Each co-processor includes a manual, software guide and Intel's lifetime warranty.

PART #	SPEED	PRICE	PART #	SPEED	PRICE
8087	5MHz	89.95	80387-DXP	33MHz	199.95
8087-2	8MHz	129.95	80387-SX20	20MHz	149.95
80287-XL	12MHz	94.95	80487-SX	20MHz	499.95

UNIVERSAL PROGRAMMER



- Programs EPROMs, EEPROMs, microprocessors, PROMs, PAL/GALs and other PLDs; tests logic & memory devices
- Optional adaptors available for PLCC, PGA, QFP and multiple DIP devices
- Includes host adaptor card and cable

MOD-EMUP \$699.00

EPROM PROGRAMMER

\$1199⁹⁵

- Programs 24-52 pin EPROMs & EEPROMs from 16K-1024K
- Hex to OBJ converter
- Vpp 5, 12.5, 12.75, 13, 21 & 25V

MOD-MEP* \$119.95

MOD-MEP-4* 4-EPROM programmer unit \$169.95

MOD-MAC Host adaptor card & cable \$29.95

*Note: Requires host adaptor card

EPROM ERASER

\$399⁹⁵

- Quickly and simultaneously erases up to 4 standard EPROMs

DATARASE II \$39.95



BREADBOARD ON-A-CARD



- Solderless breadboard with I/O, decode & timing circuitry

PDS-601 8-bit card \$79.95

PDS-611 16-bit version \$89.95

WIRE-WRAP PROTOTYPE CARDS

JDR-PR2 8-bit with I/O decode layout \$29.95

JDR-PR10 16-bit with I/O decode layout \$34.95

PORTABLE IC TESTER

- Tests the following 14 to 20-pin devices: 74 series TTL, 40 & 45 series CMOS & 41/44 series DRAM up to 1Mb
- Identifies unknown part numbers

MOD-HIC \$129.95



UPRIGHT CASE

\$999⁹⁵

- Accommodates std. motherboards
- Mounts 3 floppy and 4 hard drives
- 2 digit LED display

- CASE-100A \$99.95
- PS-250TW 250W p. supply \$129.95
- PS-300TW 300W p. supply \$149.95
- CASE-50 Mini 286-style case \$59.95
- CASE-70 Full-size stand. case \$89.95
- CASE-120 \$199.95

Mini-upright case w/200W power supply



POWER SUPPLIES

- UL approved
- 110/220V, 50/60Hz
- PS-150 8088 150 watt \$69.95
- PS-200X 8088 200 watt \$89.95
- PS-200 286/386/486 200 watt \$89.95
- PS-250 286/386/486 250 watt \$129.95
- PS-300 286/386/486 300 watt \$149.95



2400 BAUD MODEM

\$499⁹⁵

- Internal data modem
- Hayes AT compatibility
- Incl. Procomm software

MCT-241 \$49.95

2400 BAUD EXTERNAL MODEM

• 2400/1200/300 baud • Just 6.25 x 3.8 x 2 inches

PRO-24ME \$89.95

9600 BAUD EXTERNAL MODEM

- CCITT V.42bis/V.32/V.22bis/Bell 212A & Hayes AT compatible • Asynchronous / synchronous

PRO-96E \$399.95

FAX/MODEM SWITCH

- Save phone line charges! • Supports fax, modem, phone and answering machine from 1 phone line

FAXM-SWITCH \$119.95

FAX-SWITCH Without modem connection \$89.95



NOW ORDER 24 HOURS A DAY!

800-538-5000

Toll-free Fax ordering 800-538-5005

Local 408-559-1200
BBS 408-559-0253

TERMS: For shipping & handling include \$5.00 for ground & \$7.50 for air. Orders over 1 lb. and foreign orders may require additional shipping charges—contact our Sales Dept. for the amount. CA residents must include applicable sales tax. Prices subject to change without notice. We are not responsible for typographical errors. We reserve the right to limit quantities and to substitute manufacturer. All merchandise subject to prior sales. A full copy of our terms is available upon request. Items pictured may only be representative. JDR, the JDR logo, JDR Microdevices, and the MCT logo are registered trademarks of JDR Microdevices, Inc. Modular Circuit Technology is a trademark of JDR Microdevices, Inc. Copyright 1992 JDR MICRODEVICES.

KEY CODE 1030

FREE PRODUCT INFORMATION

Fill in Your Completed Card Today. For Quicker Response, Fax to 1-413-637-4343!

Circle the numbers on Inquiry Card which correspond to inquiry numbers assigned to items of interest to you.

2. Check all the appropriate answers to questions "A" through "E".

3. Print Your name and address and mail, or fax to 1-413-637-4343

Fill out this coupon carefully. PLEASE PRINT.

NAME _____
 TITLE _____
 COMPANY _____
 ADDRESS _____
 CITY () COUNTY () CODE _____
 PHONE () FAX ()

A. What is your primary job function/principal area of responsibility? (Check one.)

- 1 MIS/DP
 2 Programmer/Systems Analyst
 3 Administration/Management
 4 Sales/Marketing
 5 Engineer/Scientist
 6 Other

B. What is your level of management responsibility?

- 7 Senior-level
 8 Middle-level
 9 Professional

C. Are you a reseller (VAR, VAD, Dealer, Consultant)?

- 10 Yes
 11 No

D. What operating systems are you currently using? (Check all that apply)

- 12 PCIMS-DOS
 13 DOS + Windows
 14 OS/2
 15 UNIX
 16 Mac/OS
 17 VAX/VMS

E. For how many people do you influence the purchase of hardware or software?

- 18 1-25
 19 26-50
 20 51-99
 21 100 or more

Inquiry Numbers 1-493

1 2 3 4 5 6 7 8 9 10 11 12 13 14 15 16 17
 18 19 20 21 22 23 24 25 26 27 28 29 30 31 32 33 34
 35 36 37 38 39 40 41 42 43 44 45 46 47 48 49 50 51
 52 53 54 55 56 57 58 59 60 61 62 63 64 65 66 67 68
 69 70 71 72 73 74 75 76 77 78 79 80 81 82 83 84 85
 86 87 88 89 90 91 92 93 94 95 96 97 98 99 100 101 102
 103 104 105 106 107 108 109 110 111 112 113 114 115 116 117 118 119
 120 121 122 123 124 125 126 127 128 129 130 131 132 133 134 135 136
 137 138 139 140 141 142 143 144 145 146 147 148 149 150 151 152 153
 154 155 156 157 158 159 160 161 162 163 164 165 166 167 168 169 170
 171 172 173 174 175 176 177 178 179 180 181 182 183 184 185 186 187
 188 189 190 191 192 193 194 195 196 197 198 199 200 201 202 203 204
 205 206 207 208 209 210 211 212 213 214 215 216 217 218 219 220 221
 222 223 224 225 226 227 228 229 230 231 232 233 234 235 236 237 238
 239 240 241 242 243 244 245 246 247 248 249 250 251 252 253 254 255
 256 257 258 259 260 261 262 263 264 265 266 267 268 269 270 271 272
 273 274 275 276 277 278 279 280 281 282 283 284 285 286 287 288 289
 290 291 292 293 294 295 296 297 298 299 300 301 302 303 304 305 306
 307 308 309 310 311 312 313 314 315 316 317 318 319 320 321 322 323
 324 325 326 327 328 329 330 331 332 333 334 335 336 337 338 339 340
 341 342 343 344 345 346 347 348 349 350 351 352 353 354 355 356 357
 358 359 360 361 362 363 364 365 366 367 368 369 370 371 372 373 374
 375 376 377 378 379 380 381 382 383 384 385 386 387 388 389 390 391
 392 393 394 395 396 397 398 399 400 401 402 403 404 405 406 407 408
 409 410 411 412 413 414 415 416 417 418 419 420 421 422 423 424 425
 426 427 428 429 430 431 432 433 434 435 436 437 438 439 440 441 442
 443 444 445 446 447 448 449 450 451 452 453 454 455 456 457 458 459
 460 461 462 463 464 465 466 467 468 469 470 471 472 473 474 475 476
 477 478 479 480 481 482 483 484 485 486 487 488 489 490 491 492 493

Inquiry Numbers 494-986

494 495 496 497 498 499 500 501 502 503 504 505 506 507 508 509 510
 511 512 513 514 515 516 517 518 519 520 521 522 523 524 525 526 527
 528 529 530 531 532 533 534 535 536 537 538 539 540 541 542 543 544
 545 546 547 548 549 550 551 552 553 554 555 556 557 558 559 560 561
 562 563 564 565 566 567 568 569 570 571 572 573 574 575 576 577 578
 579 580 581 582 583 584 585 586 587 588 589 590 591 592 593 594 595
 596 597 598 599 600 601 602 603 604 605 606 607 608 609 610 611 612
 613 614 615 616 617 618 619 620 621 622 623 624 625 626 627 628 629
 630 631 632 633 634 635 636 637 638 639 640 641 642 643 644 645 646
 647 648 649 650 651 652 653 654 655 656 657 658 659 660 661 662 663
 664 665 666 667 668 669 670 671 672 673 674 675 676 677 678 679 680
 681 682 683 684 685 686 687 688 689 690 691 692 693 694 695 696 697
 698 699 700 701 702 703 704 705 706 707 708 709 710 711 712 713 714
 715 716 717 718 719 720 721 722 723 724 725 726 727 728 729 730 731
 732 733 734 735 736 737 738 739 740 741 742 743 744 745 746 747 748
 749 750 751 752 753 754 755 756 757 758 759 760 761 762 763 764 765
 766 767 768 769 770 771 772 773 774 775 776 777 778 779 780 781 782
 783 784 785 786 787 788 789 790 791 792 793 794 795 796 797 798 799
 800 801 802 803 804 805 806 807 808 809 810 811 812 813 814 815 816
 817 818 819 820 821 822 823 824 825 826 827 828 829 830 831 832 833
 834 835 836 837 838 839 840 841 842 843 844 845 846 847 848 849 850
 851 852 853 854 855 856 857 858 859 860 861 862 863 864 865 866 867
 868 869 870 871 872 873 874 875 876 877 878 879 880 881 882 883 884
 885 886 887 888 889 890 891 892 893 894 895 896 897 898 899 900 901
 902 903 904 905 906 907 908 909 910 911 912 913 914 915 916 917 918
 919 920 921 922 923 924 925 926 927 928 929 930 931 932 933 934 935
 936 937 938 939 940 941 942 943 944 945 946 947 948 949 950 951 952
 953 954 955 956 957 958 959 960 961 962 963 964 965 966 967 968 969
 970 971 972 973 974 975 976 977 978 979 980 981 982 983 984 985 986

Inquiry Numbers 987-1479

987 988 989 990 991 992 993 994 995 996 997 998 999 1000 1001 1002 1003
 1004 1005 1006 1007 1008 1009 1010 1011 1012 1013 1014 1015 1016 1017 1018 1019 1020
 1021 1022 1023 1024 1025 1026 1027 1028 1029 1030 1031 1032 1033 1034 1035 1036 1037
 1038 1039 1040 1041 1042 1043 1044 1045 1046 1047 1048 1049 1050 1051 1052 1053 1054
 1055 1056 1057 1058 1059 1060 1061 1062 1063 1064 1065 1066 1067 1068 1069 1070 1071
 1072 1073 1074 1075 1076 1077 1078 1079 1080 1081 1082 1083 1084 1085 1086 1087 1088
 1089 1090 1091 1092 1093 1094 1095 1096 1097 1098 1099 1100 1101 1102 1103 1104 1105
 1106 1107 1108 1109 1110 1111 1112 1113 1114 1115 1116 1117 1118 1119 1120 1121 1122
 1123 1124 1125 1126 1127 1128 1129 1130 1131 1132 1133 1134 1135 1136 1137 1138 1139
 1140 1141 1142 1143 1144 1145 1146 1147 1148 1149 1150 1151 1152 1153 1154 1155 1156
 1157 1158 1159 1160 1161 1162 1163 1164 1165 1166 1167 1168 1169 1170 1171 1172 1173
 1174 1175 1176 1177 1178 1179 1180 1181 1182 1183 1184 1185 1186 1187 1188 1189 1190
 1191 1192 1193 1194 1195 1196 1197 1198 1199 1200 1201 1202 1203 1204 1205 1206 1207
 1208 1209 1210 1211 1212 1213 1214 1215 1216 1217 1218 1219 1220 1221 1222 1223 1224
 1225 1226 1227 1228 1229 1230 1231 1232 1233 1234 1235 1236 1237 1238 1239 1240 1241
 1242 1243 1244 1245 1246 1247 1248 1249 1250 1251 1252 1253 1254 1255 1256 1257 1258
 1259 1260 1261 1262 1263 1264 1265 1266 1267 1268 1269 1270 1271 1272 1273 1274 1275
 1276 1277 1278 1279 1280 1281 1282 1283 1284 1285 1286 1287 1288 1289 1290 1291 1292
 1293 1294 1295 1296 1297 1298 1299 1300 1301 1302 1303 1304 1305 1306 1307 1308 1309
 1310 1311 1312 1313 1314 1315 1316 1317 1318 1319 1320 1321 1322 1323 1324 1325 1326
 1327 1328 1329 1330 1331 1332 1333 1334 1335 1336 1337 1338 1339 1340 1341 1342 1343
 1344 1345 1346 1347 1348 1349 1350 1351 1352 1353 1354 1355 1356 1357 1358 1359 1360
 1361 1362 1363 1364 1365 1366 1367 1368 1369 1370 1371 1372 1373 1374 1375 1376 1377
 1378 1379 1380 1381 1382 1383 1384 1385 1386 1387 1388 1389 1390 1391 1392 1393 1394
 1395 1396 1397 1398 1399 1400 1401 1402 1403 1404 1405 1406 1407 1408 1409 1410 1411
 1412 1413 1414 1415 1416 1417 1418 1419 1420 1421 1422 1423 1424 1425 1426 1427 1428
 1429 1430 1431 1432 1433 1434 1435 1436 1437 1438 1439 1440 1441 1442 1443 1444 1445
 1446 1447 1448 1449 1450 1451 1452 1453 1454 1455 1456 1457 1458 1459 1460 1461 1462
 1463 1464 1465 1466 1467 1468 1469 1470 1471 1472 1473 1474 1475 1476 1477 1478 1479

JUNE
IRNE006

PLACE
POSTAGE
HERE

BYTE

TNT MAILFAST
 FRG/BOS/700252/MO1
 P.O. Box 66
 Hounslow
 TW5 9RT
 England

FREE PRODUCT INFORMATION

Mail Your Completed Card Today. For Quicker Response, Fax to 1-413-637-4343!

1. Circle the numbers on Inquiry Card which correspond to inquiry numbers assigned to items of interest to you.
2. Check all the appropriate answers to questions "A" through "E".
3. Print Your name and address and mail, or fax to 1-413-637-4343

PLACE
POSTAGE
HERE

BYTE

TNT MAILFAST
FRG/BOS/700252/MO1
P.O. Box 66
Hounslow
TW5 9RT
England

Fill out this coupon carefully. PLEASE PRINT.

NAME _____
TITLE _____
COMPANY _____
ADDRESS _____
CITY _____ COUNTY _____ CODE _____
PHONE _____ FAX _____

A. What is your primary job function/principal area of responsibility? (Check one.)

- 1 MIS/DP
2 Programmer/Systems Analyst
3 Administration/Management
4 Sales/Marketing
5 Engineer/Scientist
6 Other

B. What is your level of management responsibility?

- 7 Senior-level
8 Middle-level
9 Professional

C. Are you a reseller (VAR, VAD, Dealer, Consultant)?

- 10 Yes
11 No

D. What operating systems are you currently using? (Check all that apply.)

- 12 PC/MS-DOS
13 DOS + Windows
14 OS/2
15 UNIX
16 MacOS
17 VAX/VMS

E. For how many people do you influence the purchase of hardware or software?

- 18 1-25
19 26-50
20 51-99
21 100 or more

Inquiry Numbers 1-493

1 2 3 4 5 6 7 8 9 10 11 12 13 14 15 16 17
18 19 20 21 22 23 24 25 26 27 28 29 30 31 32 33 34
35 36 37 38 39 40 41 42 43 44 45 46 47 48 49 50 51
52 53 54 55 56 57 58 59 60 61 62 63 64 65 66 67 68
69 70 71 72 73 74 75 76 77 78 79 80 81 82 83 84 85
86 87 88 89 90 91 92 93 94 95 96 97 98 99 100 101 102
103 104 105 106 107 108 109 110 111 112 113 114 115 116 117 118 119
120 121 122 123 124 125 126 127 128 129 130 131 132 133 134 135 136
137 138 139 140 141 142 143 144 145 146 147 148 149 150 151 152 153
154 155 156 157 158 159 160 161 162 163 164 165 166 167 168 169 170
171 172 173 174 175 176 177 178 179 180 181 182 183 184 185 186 187
188 189 190 191 192 193 194 195 196 197 198 199 200 201 202 203 204
205 206 207 208 209 210 211 212 213 214 215 216 217 218 219 220 221
222 223 224 225 226 227 228 229 230 231 232 233 234 235 236 237 238
239 240 241 242 243 244 245 246 247 248 249 250 251 252 253 254 255
256 257 258 259 260 261 262 263 264 265 266 267 268 269 270 271 272
273 274 275 276 277 278 279 280 281 282 283 284 285 286 287 288 289
290 291 292 293 294 295 296 297 298 299 300 301 302 303 304 305 306
307 308 309 310 311 312 313 314 315 316 317 318 319 320 321 322 323
324 325 326 327 328 329 330 331 332 333 334 335 336 337 338 339 340
341 342 343 344 345 346 347 348 349 350 351 352 353 354 355 356 357
358 359 360 361 362 363 364 365 366 367 368 369 370 371 372 373 374
375 376 377 378 379 380 381 382 383 384 385 386 387 388 389 390 391
392 393 394 395 396 397 398 399 400 401 402 403 404 405 406 407 408
409 410 411 412 413 414 415 416 417 418 419 420 421 422 423 424 425
426 427 428 429 430 431 432 433 434 435 436 437 438 439 440 441 442
443 444 445 446 447 448 449 450 451 452 453 454 455 456 457 458 459
460 461 462 463 464 465 466 467 468 469 470 471 472 473 474 475 476
477 478 479 480 481 482 483 484 485 486 487 488 489 490 491 492 493

Inquiry Numbers 494-986

494 495 496 497 498 499 500 501 502 503 504 505 506 507 508 509 510
511 512 513 514 515 516 517 518 519 520 521 522 523 524 525 526 527
528 529 530 531 532 533 534 535 536 537 538 539 540 541 542 543 544
545 546 547 548 549 550 551 552 553 554 555 556 557 558 559 560 561
562 563 564 565 566 567 568 569 570 571 572 573 574 575 576 577 578
579 580 581 582 583 584 585 586 587 588 589 590 591 592 593 594 595
596 597 598 599 600 601 602 603 604 605 606 607 608 609 610 611 612
613 614 615 616 617 618 619 620 621 622 623 624 625 626 627 628 629
630 631 632 633 634 635 636 637 638 639 640 641 642 643 644 645 646
647 648 649 650 651 652 653 654 655 656 657 658 659 660 661 662 663
664 665 666 667 668 669 670 671 672 673 674 675 676 677 678 679 680
681 682 683 684 685 686 687 688 689 690 691 692 693 694 695 696 697
698 699 700 701 702 703 704 705 706 707 708 709 710 711 712 713 714
715 716 717 718 719 720 721 722 723 724 725 726 727 728 729 730 731
732 733 734 735 736 737 738 739 740 741 742 743 744 745 746 747 748
749 750 751 752 753 754 755 756 757 758 759 760 761 762 763 764 765
766 767 768 769 770 771 772 773 774 775 776 777 778 779 780 781 782
783 784 785 786 787 788 789 790 791 792 793 794 795 796 797 798 799
800 801 802 803 804 805 806 807 808 809 810 811 812 813 814 815 816
817 818 819 820 821 822 823 824 825 826 827 828 829 830 831 832 833
834 835 836 837 838 839 840 841 842 843 844 845 846 847 848 849 850
851 852 853 854 855 856 857 858 859 860 861 862 863 864 865 866 867
868 869 870 871 872 873 874 875 876 877 878 879 880 881 882 883 884
885 886 887 888 889 890 891 892 893 894 895 896 897 898 899 900 901
902 903 904 905 906 907 908 909 910 911 912 913 914 915 916 917 918
919 920 921 922 923 924 925 926 927 928 929 930 931 932 933 934 935
936 937 938 939 940 941 942 943 944 945 946 947 948 949 950 951 952
953 954 955 956 957 958 959 960 961 962 963 964 965 966 967 968 969
970 971 972 973 974 975 976 977 978 979 980 981 982 983 984 985 986

Inquiry Numbers 987-1479

987 988 989 990 991 992 993 994 995 996 997 998 999 1000 1001 1002 1003
1004 1005 1006 1007 1008 1009 1010 1011 1012 1013 1014 1015 1016 1017 1018 1019 1020
1021 1022 1023 1024 1025 1026 1027 1028 1029 1030 1031 1032 1033 1034 1035 1036 1037
1038 1039 1040 1041 1042 1043 1044 1045 1046 1047 1048 1049 1050 1051 1052 1053 1054
1055 1056 1057 1058 1059 1060 1061 1062 1063 1064 1065 1066 1067 1068 1069 1070 1071
1072 1073 1074 1075 1076 1077 1078 1079 1080 1081 1082 1083 1084 1085 1086 1087 1088
1089 1090 1091 1092 1093 1094 1095 1096 1097 1098 1099 1100 1101 1102 1103 1104 1105
1106 1107 1108 1109 1110 1111 1112 1113 1114 1115 1116 1117 1118 1119 1120 1121 1122
1123 1124 1125 1126 1127 1128 1129 1130 1131 1132 1133 1134 1135 1136 1137 1138 1139
1140 1141 1142 1143 1144 1145 1146 1147 1148 1149 1150 1151 1152 1153 1154 1155 1156
1157 1158 1159 1160 1161 1162 1163 1164 1165 1166 1167 1168 1169 1170 1171 1172 1173
1174 1175 1176 1177 1178 1179 1180 1181 1182 1183 1184 1185 1186 1187 1188 1189 1190
1191 1192 1193 1194 1195 1196 1197 1198 1199 1200 1201 1202 1203 1204 1205 1206 1207
1208 1209 1210 1211 1212 1213 1214 1215 1216 1217 1218 1219 1220 1221 1222 1223 1224
1225 1226 1227 1228 1229 1230 1231 1232 1233 1234 1235 1236 1237 1238 1239 1240 1241
1242 1243 1244 1245 1246 1247 1248 1249 1250 1251 1252 1253 1254 1255 1256 1257 1258
1259 1260 1261 1262 1263 1264 1265 1266 1267 1268 1269 1270 1271 1272 1273 1274 1275
1276 1277 1278 1279 1280 1281 1282 1283 1284 1285 1286 1287 1288 1289 1290 1291 1292
1293 1294 1295 1296 1297 1298 1299 1300 1301 1302 1303 1304 1305 1306 1307 1308 1309
1310 1311 1312 1313 1314 1315 1316 1317 1318 1319 1320 1321 1322 1323 1324 1325 1326
1327 1328 1329 1330 1331 1332 1333 1334 1335 1336 1337 1338 1339 1340 1341 1342 1343
1344 1345 1346 1347 1348 1349 1350 1351 1352 1353 1354 1355 1356 1357 1358 1359 1360
1361 1362 1363 1364 1365 1366 1367 1368 1369 1370 1371 1372 1373 1374 1375 1376 1377
1378 1379 1380 1381 1382 1383 1384 1385 1386 1387 1388 1389 1390 1391 1392 1393 1394
1395 1396 1397 1398 1399 1400 1401 1402 1403 1404 1405 1406 1407 1408 1409 1410 1411
1412 1413 1414 1415 1416 1417 1418 1419 1420 1421 1422 1423 1424 1425 1426 1427 1428
1429 1430 1431 1432 1433 1434 1435 1436 1437 1438 1439 1440 1441 1442 1443 1444 1445
1446 1447 1448 1449 1450 1451 1452 1453 1454 1455 1456 1457 1458 1459 1460 1461 1462
1463 1464 1465 1466 1467 1468 1469 1470 1471 1472 1473 1474 1475 1476 1477 1478 1479

JUNE

IRNE006

SUBSCRIBE TO BYTE!

With BYTE, you can compete more effectively in complex global markets...

YES I want to receive BYTE for a full year. 12 monthly issues plus the FREE Annual Special Issue.

Payment method — charge my subscription to:

- Visa Access/Eurocard/MasterCard American Express

Card No: _____ Expiry date _____

Signature: _____

or I enclose payment now

Name _____ Title _____
(Please Print)

Address _____

_____ Code _____

Country _____

Please allow 8-10 weeks for processing. Thank you.

For fastest service — call from within the UK at 0628-23431. Outside the UK call 44-628-23431. Or fax credit card order 0628-782181 from within UK. From outside the UK 44-628-782181.

Your satisfaction is GUARANTEED! If you are dissatisfied, cancel anytime for a refund on all unmailed issues.

✓ Tick your subscription price Please tick one box:

- Fast Surface Delivery IB26150**
 £29 United Kingdom
 100 DM Germany
 343FF France
 113 Guilders Netherlands
 85 SFR Switzerland
 74,150 Lire Italy
 \$US50 All other European Countries

- Air Delivery IB26168**
 £41 United Kingdom
 140DM Germany
 480 FF France
 158 Guilders Netherlands
 119 SFR Switzerland
 103,810 Lire Italy
 \$US70 All other European Countries

PAR AVION **BYTE HAS EXCLUSIVE GLOBAL COVERAGE...** **BY AIR MAIL** **PAR AVION**

*each month, you can take advantage of BYTE's International Section with hard-hitting news, and coverage of important world-wide events...

YES I want to receive BYTE for a full year. 12 monthly issues plus the FREE Annual Special Issue.

Payment method — charge my subscription to:

- Visa Access/Eurocard/MasterCard American Express

Card No: _____ Expiry date _____

Signature: _____

or I enclose payment now

Name _____ Title _____
(Please Print)

Address _____

_____ Code _____

Country _____

Please allow 8-10 weeks for processing. Thank you.

For fastest service — call from within the UK at 0628-23431. Outside the UK call 44-628-23431. Or fax credit card order 0628-782181 from within UK. From outside the UK 44-628-782181.

Your satisfaction is GUARANTEED! If you are dissatisfied, cancel anytime for a refund on all unmailed issues.

✓ Tick your subscription price Please tick one box:

- Fast Surface Delivery IB26150**
 £29 United Kingdom
 100 DM Germany
 343FF France
 113 Guilders Netherlands
 85 SFR Switzerland
 74,150 Lire Italy
 \$US50 All other European Countries

- Air Delivery IB26168**
 £41 United Kingdom
 140DM Germany
 480 FF France
 158 Guilders Netherlands
 119 SFR Switzerland
 103,810 Lire Italy
 \$US70 All other European Countries

... and receive up to date information on new products and emerging technologies.

SUBSCRIBE TO BYTE!

BY AIR MAIL
PAR AVION

Place
Stamp
Here

BYTE

McGraw-Hill Information Services
McGraw-Hill House
Shoppenhangers Road
Maidenhead, Berkshire SL6 2QL
England



FAST & CONVENIENT!

Have BYTE delivered direct to your door
and never miss an issue again!

BY AIR MAIL
PAR AVION

BY AIR MAIL
PAR AVION

Place
Stamp
Here

BYTE

McGraw-Hill Information Services
McGraw-Hill House
Shoppenhangers Road
Maidenhead, Berkshire SL6 2QL
England

READER SERVICE

ALPHABETICAL INDEX TO ADVERTISERS

Inquiry No.	Page No.	Inquiry No.	Page No.	Inquiry No.	Page No.	Inquiry No.	Page No.
312 3-D VISIONS	197	250 CURTIS INC	402	121 LAHEY COMPUTER SYSTEMS	108	147 QUANTUM SOFTWARE	363
69-70 ABACUS SOFTWARE	139	229-234 CYBER RESEARCH	377	221-222 LANDMARK RES INT'L CORP	269	* QUARTERDECK OFFICE SYS	120A-P
8-9 ABACUS SOFTWARE	227	583 CYBERTRON	400PC-8	241 LANWISE INC	380	309 QUARTERDECK OFFICE SYS	120
456-457 ACE CAD	100IS-58	204 CYBEX CORPORATION	372	290 LAPTOP SOLUTIONS, INC	405	283 QUIET TECHNOLOGY	406
71-72 ACER INCORPORATED	59	92 CYBEX CORPORATION (INT'L)	CIII	53-54 LIANT SOFTWARE CORP (N.A.)	185	149 RAIMA CORP	99
554 ACTION COMP SUPPLIES	400MW-4	451 DAN TECHNOLOGY PLC	100IS-5	55-56 LIANT SOFTWARE CORP (INT'L)	185	35-36 RAINBOW TECHNOLOGIES	175
571 ACTION COMP SUPPLIES	400NE-5	93-94 DATA ACCESS CORP	251	315-316 LIANT SOFTWARE CORP (N.A.)	361	* REASONABLE SOLU	100IS-60A-B
197 ADVANCED COMPUTER PROD	386	251 DATACAP	409	317-318 LIANT SOFTWARE CORP (INT'L)	361	589 RECORTEC INC	400SO-11
73-74 ADVANCED LOGIC RESEARCH	301	95-96 DATALUX CORPORATION	150	122 LIBREX COMPUTER SYS (N.A.)	96,97	295 RENEGADE	404
76 ADVANCED MICRO DEVICES	112,113	252 DATAPATH TECHNOLOGIES, INC	405	261 LINK COMPUTER GRAPHICS	407	313 ROSE ELECTRONICS	380
67 AG COMMUNICATION SYS	179	24 DATASTORM TECHNOLOGIES	169	236 LODGE STAR COMPUTER	368,369	37-38 RR SOFTWARE	238
411-412 AGC ELECTRONICS CORP	100IS-53	301 DAVIS INSTRUMENTS	409	179 LOGICUS INCORPORATED	176	150 S'NW ELECTRONICS	108
466 AIR TECH	100IS-9	98 DELL COMPUTER CORP (N.A.)	CIII	123-124 LOGITECH INC	163	443 S'NW ELECTRONICS	100IS-16
75 ALADDIN KNOWLEDGE SYS	71	99 DELL COMPUTER CORP (N.A.)	CIV	437-438 LONGSHINE ELECT CORP	100IS-48	569 SAI SYSTEMS	400NE-2
413 AMDS EUROPE LTD	100IS-15	97 DELPHI	425	59-60 LUCAS MANAGEMENT SYS	209	269 SAS INSTITUTE INC	410
* AME INSTIT FOR COMP SCI	410	188 DIGITAL CONSULTING INC	345	406 MAGSTORE	100UK-8	240 SECURTECH COMPANY	400
414 AMER BUYING & EXPORTING	100IS-58	* DIGITAL EQUIPMENT CORP	165	* MANCHESTER EQUIP CO	400NE-A-B	58 SEQUELINK/GNOSIS NV	239
77-78 AMERICAN MEGATRENDS	105	398 DIGITAL EQUIP CORP (N.A.)	100A-H	568 MANCHESTER EQUIP CO	400NE-1	39 SEQUITER SOFTWARE INC	225
415 AMERICAN POWER CONV	100IS-46	560 DIGITAL MEDIA LABS	400MW-2	* MARK WILLIAMS CO	115	273 SIGEN	405
79 AMERICAN POWER CONV (N.A.)	283	603 DIGITAL MEDIA LABS	400SO-4	127 MATHSOFT INC	174	* SILICON GRAPHICS	144
80 AMERICAN SMALL BUSI COMP	95	101 DIGITAL RESEARCH INC (N.A.)	151	126 MATHSOFT INC	253	180 SIMPLICITY COMPUTING	236
258 AMRAM	406	253 DIVERSIFIED COMPUTER SYS	409	439-440 MEGADATA	100IS-28	* SOFTLINE CORP	100IS-21
198 AMT INCORPORATED	396	205-206 DPT	393	286 MEMORY PIPELINE	406	307-308 SOFTWARE SECURITY INC	110
579 ANCOT CORPORATION	400PC-8	102 DSP DEV CORP	152	557 MICRO DATA COMPUTERS	400MW-8	152 SONY (N.A.)	147
324-325 AOX	228	207 E T VALUELINE/ELEK-TEK	378	574 MICRO DATA COMPUTERS	400NE-12	153 SONY (N.A.)	153
245 APPLIED CONCEPTS	406	410 E. I. T. LTD	100UK-13	585 MICRO DATA COMPUTERS	400PC-3	154 SPECTRUM SOFTWARE	262
592 APPRO INT'L INC	400SO-7	103 EASTMAN KODAK CO	325	601 MICRO DATA COMPUTERS	400SO-12	155-156 STASTOFT	285
311 APPROACH SOFTWARE	167	402 EDINBURGH PORTABLE COMPLAS	100UK-17	218 MICRO SOLUTIONS COMP PROD	391	444-445 STONY BROOK SOFTWARE	100IS-11
* APS TECHNOLOGIES	397	57 ELOGRAPHICS	202	597-598 MICRO-INTERNATIONAL INC	400SO-2	270 STRADA AUTOTECH, INC	402
416 ASP COMPUTER PROD	100IS-14	* ELOXNET	100IS-2	63 MICROCAL INC	238	157 STRATEGIC MAPPING	111
330-331 ATI RESEARCH INC	195	25 ETAP	239	235 MICROLANE COMPUTERS INC	389	158 SUMMAGRAPHICS CORP	249
10 ATI TECHNOLOGIES INC	231	562-563 EVOLUTION COMPUTING	400NE-7	263 MICROPROCESSORS UNLTD	406	553 SUMMIT MICRO DESIGN	400MW-3
159 ATRONICS	370	577-578 EVOLUTION COMPUTING	400PC-7	217 MICROPROSE SOFTWARE	379	159 SUN MICROSYSTEMS	128,129
11 AUTODESK INC	156-158	303 EXALINX, INC	403	* MICROSOFT CORPORATION	8,9	190 SUNSOFT	117
292-293 AXIOM	402	401 EXPERT SYSTEMS LTD	100UK-12	* MICROSOFT CORPORATION	21	271 SURAH INC	403
246 B&C MICROSYSTEMS	407	426 FAST ELECTRONIC GMBH	100IS-29	* MICROSOFT CORPORATION	67	178 SYMANTEC / ZORTECH	52
319-320 BAY TECHNICAL ASSOC	381	453-454 FIRST INT'L COMPUTER	100IS-41	* MICROSOFT CORPORATION	83	51 SYMANTEC / ZORTECH	170,171
200-201 BAY TECHNICAL ASSOC	383	208-209 FIRST SOURCE INT'L	388	* MICROSOFT CORPORATION	106,107	160 SYGEN INC	295
602 BEC	400SO-5	26-27 FORESIGHT RESOURCES	223	* MICROSOFT CORPORATION	119	161-162 SYSTAT INC	278
247 BECTERM INCORPORATED	402	104 FOX SOFTWARE INC	88-89	* MICROSOFT CORPORATION	142,143	407 SYSTEMSTAR	100UK-15
* BIX	147	254 FLOXT CORP	410	* MICROSOFT CORPORATION	149	467-468 TATUNG CO	100IS-55
450 BIX	424	105 FRAME TECHNOLOGY	141	264 MICROSTAR LABORATORIES	404	581 TDSI, INC	400PC-6
417 BLAISE COMPUTING INC	100IS-36	403 GANDLAK GROUP	100UK-5	* MICROWAY	130	272 TECHNOLOGY PWR ENTRPRSE, INC	403
81-82 BORLAND INTERNATIONAL	17	* GATEWAY 2000	CII,1	* MICROWAY	358	471-472 TECHPOWER COMPANY LTD	100IS-10
12-13 BORLAND INTERNATIONAL	161	* GATEWAY 2000	33-44	582 MICROWORLD	400PC-5	469-470 TECHPOWER COMPANY LTD	100IS-12
14-15 BORLAND INTERNATIONAL	247	321 GENOA SYSTEMS	201	452 MINICOM LTD	100IS-38	163 TEKTRONIX	328,329
299-300 BPS INTERNATIONAL	406	427 GFK HAMBURG	100IS-47	441 MINOLTA GMBH	100IS-27	164 TELETYPE TECHNOLOGY	154
399 BUFFALO PRODUCTS	375	106-107 GLENCO ENGINEERING	326	442 MIX SOFTWARE	100IS-35	296-297 TELELINK	403
83-84 BUREAU OF ELECT PUBL	102	* GLOBALINK INC	400SO-A-B	130 MORTICE KERN (MKS)	137	288 TEMPUS TECH, INC	402
243-244 BUSINESS INSTR	398	587-588 GLOBALINK INC	400SO-1	131 MOTOROLA INC	22-23	40 TEXAS INSTRUMENTS	193
604 BYTE CARD DECK	400MW-6	564-565 GLOBALINK INC	400NE-9	184 MOUNTAIN NETWK SOLU (INT'L)	CIV	165 TEXAS INSTRUMENTS	56,57
605 BYTE CARD DECK	400NE-6	302 GRAMMAR ENGINE, INC	410	409 NAG	100UK-2	570 THE WNDX CORP	400NE-3
332 BYTE EURODECK	164	428 GREY MATTER LTD	100IS-17	31-32 NANAOU USA CORP	213	580 THE WNDX CORP	400PC-1
329 BYTE LISTINGS ON DISK	230	255 GTEK INC	403	219-220 NATIONAL DESIGN	371	284 TIEPIE ENGINEERING	404
327 BYTE REPRINTS	276	210-211 H. CO. COMP PROD	374	33 NATIONAL INSTRUMENTS	239	166 TMS	303
328 BYTE SUB MESSAGE	236	463 HANDTOP COMPUTERS LTD	100IS-49	* NATIONAL INSTRU	100IS-60C-D	167 TOSHIBA AMERICA INC	50,51
100 BYTE/DEMOLINK	423	305-306 HAN DYKEY	405	133 NEC	68,69	310 TOTE-A-LAP	387
333 BYTEWEEK	243	429 HANTAREX SPA	100IS-19	132 NEC	87	168-169 TOUCHSTONE SOFTWARE	114
334 BYTEWEEK	401	* HARD DRIVES INT'L	373	134 NEC	254,255	281 TRANTOR SYSTEMS LTD	405
* C USERS JOURNAL	100IS-60C-D	28 HAUPPAUGE COMP WORKS	235	214 NEVADA COMPUTER	392	282 TRI VALLEY TECH INC	404
304 CADSOFT COMPUTER, INC	409	29 HERCULES COMPUTER TECH	221	572 NEW ENGLAND ELECT	400NE-10	274 TRIANGLE DIGITAL SERVICES	404
462 CANON EUROPA N.V.	100IS-13	566-567 HERTZ	400NE-8	285 NILES & ASSOCIATES INC	410	275-276 TRIBAL MICROSYSTEMS	408
86 CANON USA INC	321	* HEWLETT PACKARD	7	* NORTHGATE COMPUTER SYS	84,85	447 TULIN TECHNOLOGY	100IS-40
85 CANON USA INC	356	256 HOLEON CORPORATION	405	* NORTHGATE COMPUTER SYS	203-205	223-224 ULTIMA ELECTRONICS CORP	398
87 CAPITAL EQUIPMENT CO	264	430 I-COM	100IS-40	186-187 ODYSSEY DEVELOPMENT	324	* ULTIMATE TECH	100IS-60A-B
88 CAPITAL EQUIPMENT CO	265	109 IBM CORP	30,31	291 OMNITECH ELECTRONICS, INC	408	448 UNIAIR	100IS-42
460 CASE DESIGN	100IS-22	108 IBM CORP	60,61	458 ON TIME MKRTKARSTEN PETERSEN	100IS-60	459 UNITRON	100IS-33
322-323 CELERITE GRAPHICS INC	237	600 ICS COMPUTER	400SO-3	265 OVERLAND DATA INC	408	225-226 UNIVERSAL MEMORY PROD	399
192-193 CERTUS INT'L CORP	80,81	593-594 IEPS	400SO-6	* PACIFIC DATA PRODUCTS	323	* UNIXWORLD	334A-B
238-239 CITITRONICS	384	61-62 IMAGE NORTH TECH	222	68 PACIFIC GOLD COAST	214	* UNIXWORLD	335
418-419 CLARION SOFTWARE	100IS-37	116 INTEGRAND RESEARCH	282	135 PANASONIC	26,27	326 VALITEC INC	362
424 COBALT BLUE	100IS-16	112-113 INTEGRATED INFO TECH	297	136 PARA SYSTEMS	127	170-171 VENTURA SOFTWARE INC	92,93
420-421 COMPEX	100IS-31	114-115 INTEGRATED INFO TECH	299	266 PATTON & PATTON	410	* VENTURA SOFTWARE INC	92A-B
202 COMPEX INTERNATIONAL	396	117 INTEL CORPORATION	46,47	556 PC IMPORTERS INC	400MW-6	41-42 VENTURA SOFTWARE INC	186,187
89 COMPUADD EXPRESS	75-77	314 INTEL CORPORATION	288,289	573 PC IMPORTERS INC	400NE-6	172 VERMONT CREATIVE SW	55
287 COMPUBOOKS	409	185 INTERACTIVE IMAGE TECH	104	584 PC IMPORTERS INC	400PC-6	43-44 VIEWSONIC	229
18 COMPUCLASSICS	212	212-213 INTERSYS	395	599 PC IMPORTERS INC	400SO-6	404 VOGUE COMP CO. LTD, THE	100UK-11
422 COMPUCLASSICS	100IS-6	* INTUIT INC	2,3	137-138 PC POWER & COOLING	103	449 WALKER, RICHER & QUINN	100IS-45
423 COMPUSAVE INT'L	100IS-39	257 IO TECH	407	551-552 PC-EASE INC	400MW-5	173 WATCOM PRODUCTS INC	29
* COMPUSERVE	133,134	473 ITALIAN S/W AGENCY	100IS-51	590-591 PC-EASE INC	400SO-9	174-175 WESTERN DIGITAL	109
90 COMPUSERVE	135	118 JAMECO ELECTRONICS	72-73	139-140 PERSPECTIVE COMPANY, THE	116	294 WILCO AMS	407
21 COMPUTER ASSOCIATES	183	461 JASON MACKENZIE	100IS-32	141-142 PINNACLE MICRO	18-19	* WINDOWS/DOS JOURNAL	100IS-60C-D
19 COMPUTER ASSOCIATES	199	* JDR MICRODEVICES	418	143 PIONEER COMMUNICATIONS	125	561 WINDOWS & OS/2 CONFERENCE	400NE-11
20 COMPUTER ASSOCIATES	218	455 JEN ELECTRONICA	100IS-25	144 PKWARE INC	304	278 WINTEK CORP	409
425 COMPUTER QUICK	100IS-8	30 KEA SYSTEMS LTD	168	586 PLUSTEK USA, INC	400PC-2	555 WIT	400MW-7
242 COMPUTER WAREHOUSE	390	262 KEITHLEY METRABYTE	404	298 PMP/MEMORY WORLD	402	47-49 WOLFRAM RESEARCH	191
203 COMPUTERLANE UNLTD	417	259 KILA	403	34 POPKIN SOFTWARE	215	237 WORLDWIDE TECHNOLOGIES	382
227-228 COMTRADE	385	558-559 KINGLI TECHNOLOGY, INC	400MW-1	125 PROGRAMMER'S PARADISE	63-65	279 XELTEC	408
* COPIA INTERNATIONAL	184	575-576 KINGLI TECHNOLOGY, INC	400NE-4	* PROGRAMMER'S SHOP	240-242	45-46 XYT SOFTWARE INC	234
91 COREL SOFTWARE	24	119-120 KINGSTON TECHNOLOGY	252	145-146 PROTECH MARKETING INC	275	50 Z-NIX COMPANY INC	233
248-249 COVOX INC	402	435-436 KUO FENG CORP	100IS-34	267 PSEUDOCORP	410	280 Z-WORLD ENGINEERING	408
181 CREATIVE LABS INC	343	191 KYOCERA ELECTRONICS (N.A.)	261	408 PSION	100UK-6,7	464-465 ZECKS	100IS-30
66 CSI PUBLISHING, INC	238	289 L-COM, INC	403	148 QUA TECH INC	366	176 ZENITH DATA SYSTEMS	91
22-23 CTX INT'L INC	177	260 LAGUNA DATA SYSTEMS	408	268 QUALSTAR CORP	408	177 ZEOS INTERNATIONAL	11-15

*Correspond directly with company.

INDEX TO ADVERTISERS BY PRODUCT CATEGORY

Inquiry No.	Page No.	Inquiry No.	Page No.	Inquiry No.	Page No.	Inquiry No.	Page No.	
HARDWARE								
926 ACCESSORIES/SUPPLIES								
554	ACTION COMP SUPPLIES	400MW-4	571	ACTION COMP SUPPLIES	400NE-5	240	SECURTECH COMPANY	
152	SONY (N.A.)	147	284	TIEPIE ENGINEERING	404	464-465	ZECKS	
927 ADD-IN BOARDS								
77-78	AMERICAN MEGATRENDS	105	10	ATI TECHNOLOGIES INC	231	292-293	AXIOM	
247	BECTERM INCORPORATED	402	420-421	COMPEX	100IS-31	248-249	COVOX INC	
181	CREATIVE LABS INC	343	250	CURTIS INC	402	560	DIGITAL MEDIA LABS	
603	DIGITAL MEDIA LABS	400MW-2	205-206	DPT	393	25	ETAP	
453-454	FIRST INT'L COMPUTER	100IS-41	321	GENOA SYSTEMS	201	427	GFK HAMBURG	
29	HERCULES COMPUTER TECH	221	118	JAMECO ELECTRONICS	72, 73	46	JASON MACKENZIE	
455	JEN ELECTRONICA	100IS-25	221-222	LANDMARK RES INT'L CORP	269	*	MICROWAY	
219-220	NATIONAL DESIGN	371	139-140	PERISCOPE COMPANY, THE	116	298	PMP/MEMORY WORLD	
148	QUA TECH INC	366	270	STRADA AUTOTECH, INC	402	288	TEMPUTECH, INC	
447	TULIN TECHNOLOGY	100IS-40	174-175	WESTERN DIGITAL	109			
928 COMMUNICATIONS/NETWORKING								
71-72	ACER INCORPORATED	59	319-320	BAY TECHNICAL ASSOC	381	255	GTEK INC	
289	L-COM, INC	403	437-438	LONGSHINE ELECT CORP	100IS-48	452	MINICOM LTD	
467-468	TATUNG CO	100IS-55	296-297	TELELINK	403			
929 COMPUTER SYSTEMS								
71-72	ACER INCORPORATED	59	411-412	AGC ELECTRONICS CORP	100IS-53	592	APPRO INT'L INC	
330-331	AST RESEARCH INC	195	199	ATRONICS	370	602	BEC	
238-239	CITITRONICS	384	202	COMPEX INTERNATIONAL	396	89	COMPUADD EXPRESS	
227-228	CONTRADE	385	583	CYBERTROL	400PC-8	451	DAN TECHNOLOGY PLC	
95-96	DATALUX CORPORATION	100IS-5	96	DELL COMPUTER CORP (N.A.)	CII	99	DELL COMPUTER CORP (N.A.)	
398	DIGITAL EQUIPMENT CORP (N.A.)	100A-H	207	E T VALUELINE/ELEK-TEK	378	*	ELONEX	
303	EXALINX, INC	403	453-454	FIRST INT'L COMPUTER	100IS-41	403	GANDLAKE GROUP	
566-567	HERTZ	400NE-8	600	ICS COMPUTER	400S-3	212-213	INTERSYS	
558-559	KINGLI TECHNOLOGY, INC	400MW-1	437-438	LONGSHINE ELECT CORP	100IS-48	*	MANCHESTER EQUIP CO	
439-440	MEGADATA	100IS-28	557	MICRO DATA COMPUTERS	400MW-8	574	MICRO DATA COMPUTERS	
585	MICRO DATA COMPUTERS	400PC-3	601	MICRO DATA COMPUTERS	400S-12	597-598	MICRO-INTERNATIONAL, INC	
235	MICROLANE COMPUTERS INC	389	582	MICROWORLD	400PC-5	572	NEW ENGLAND ELECT	
556	PC IMPORTERS INC	400MW-6	573	PC IMPORTERS INC	400NE-6	584	PC IMPORTERS INC	
589	PC IMPORTERS INC	400PC-6	594	PC IMPORTERS INC	400S-6	137-138	PC POWER & COOLING	
551-552	PC-EASE INC	400MW-5	590-591	PC-EASE INC	400S-9	295	RENEGADE	
319-320	BAY TECHNICAL ASSOC	381	243-244	BUSINESS INSTRUMENTS	398	296-297	TELELINK	
930 DATA ACQUISITION								
262	KEITHLEY METRABYTE	404	264	MICROSTAR LABORATORIES	404			
931 DISK & OPTICAL DRIVES								
77-78	AMERICAN MEGATRENDS	105	*	APS TECHNOLOGIES	397	*	HARD DRIVES INTERNAT	
406	MAGSTORE	100UK-8	218	MICRO SOLUTIONS COMP PROD	391	141-142	PINNACLE MICRO	
143	PIONEER COMMUNICATIONS	125	273	SIGEN	405	180	SIMPLICITY COMPUTING	
153	SONY (N.A.)	153	271	SURAH INC	403	160	SYSGEN INC	
281	TRANTOR SYSTEMS LTD	405						
932 DISKETTES/DUPLICATORS								
252	DATAPATH TECHNOLOGIES, INC	405						
933 FAX BOARDS/MACHINES								
558-559	KINGLI TECHNOLOGY, INC	400MW-1	575-576	KINGLI TECHNOLOGY, INC	400NE-4			
934 GRAPHICS TABLETS/MICE/PEN INPUT								
456-457	ACE CAD	100IS-58	57	ELOGRAPHICS	202	305-306	HANDYKEY	
123-124	LOGITECH INC	163	158	SUMMAGRAPHICS CORP	249	50	Z-NIX COMPANY INC	
935 KEYBOARDS								
95-96	DATALUX CORPORATION	150	256	HOOLEEN CORPORATION	405	*	NORTHGATE COMPUTER SYS	
936 LAN HARDWARE								
204	CYBEX CORPORATION	372	92	CYBEX CORPORATION (INT'L)	CII	403	GANDLAKE GROUP	
452	MINICOM LTD	100IS-38	184	MOUNTAIN NETWK SOLU (INT'L)	CIV	137-138	PC POWER & COOLING	
271	SURAH INC	403						
937 LAPTOPS & NOTEBOOKS								
71-72	ACER INCORPORATED	59	73-74	ADVANCED LOGIC RESEARCH	301	398	DIGITAL EQUIP CORP (N.A.)	
453-454	FIRST INT'L COMPUTER	100IS-41	403	GANDLAKE GROUP	100UK-5	290	LAPTOP SOLUTIONS, INC	
122	LIBREX COMPUTER SYS (N.A.)	96, 97	134	NEC	254, 255	*	NORTHGATE COMPUTER SYS	
408	PSION	100UK-6, 7	40	TEXAS INSTRUMENTS	193	167	TOSHIBA AMERICA INC	
310	TOTE-A-LAP	387	177	ZEOS INTERNATIONAL	11-15			
938 MAIL ORDER								
197	ADVANCED COMPUTER PROD	386	414	AMER BUYING & EXPORTING	100IS-58	198	AMT INCORPORATED	
238-239	CITITRONICS	384	89	COMPUADD EXPRESS	75-77	242	COMPUTER WAREHOUSE	
203	COMPUTERLANE UNLTD	417	229-234	CYBER RESEARCH	377	398	DIGITAL EQUIP CORP (N.A.)	
560	DIGITAL MEDIA LABS	400MW-2	603	DIGITAL MEDIA LABS	400S-4	210-211	H. CO. COMPUTER PROD	
118	JAMECO ELECTRONICS	72, 73	*	JDR MICRODEVICES	418	289	L-COM, INC	
241	LANWISE INC	380						
939 MEMORY/CHIPS/UPGRADES								
76	ADVANCED MICRO DEVICES	112, 113	413	AMDS EUROPE LTD	100IS-15	258	AMRAM	
324-325	AOX	226	299-300	BPS INTERNATIONAL	406	87	CAPITAL EQUIPMENT CO	
88	CAPITAL EQUIPMENT CO	265	208-209	FIRST SOURCE INT'L	388	28	HAUPPAUGE COMP WORKS	
112-113	INTEGRATED INFO TECH	297	114-115	INTEGRATED INFO TECH	299	117	INTEL CORPORATION	
314	INTEL CORPORATION	46, 47	118	JAMECO ELECTRONICS	72, 73	119-120	KINGSTON TECHNOLOGY	
286	MEMORY PIPELINE	406	263	MICROPROCESSORS UNLTD	406	225-226	UNIVERSAL MEMORY PROD	
237	WORLDWIDE TECHNOLOGIES	382						
940 MISCELLANEOUS HARDWARE								
554	ACTION COMP SUPPLIES	400MW-4	571	ACTION COMP SUPPLIES	400NE-5	245	APPLIED CONCEPTS	
246	B&C MICROSYSTEMS	407	462	CANON EUROPA N.V.	100IS-13	181	CREATIVE LABS INC	
410	E. I. T. LTD	100UK-13	116	INTEGRAND RESEARCH	282	131	MOTOROLA INC	
283	QUIET TECHNOLOGY	406	240	SECURTECH COMPANY	400	284	TIEPIE ENGINEERING	
941 MODEMS/MULTIPLEXORS								
319-320	BAY TECHNICAL ASSOC	381	243-244	BUSINESS INSTRUMENTS	398	296-297	TELELINK	
942 MONITORS & TERMINALS								
22-23	CTX INTERNATIONAL INC	177	25	ETAP	239	429	HANTAREX SPA	
108	IBM CORP	60, 61	435-436	KUO FENG CORP	100IS-34	31-32	NANAO USA CORP	
133	NEC	68, 69	467-468	TATUNG CO	100IS-55	43-44	VIEWSONIC	
943 MULTIMEDIA								
462	CANON EUROPA N.V.	100IS-13	85	CANON USA INC	356	181	CREATIVE LABS INC	
22-23	CTX INT'L INC	177	560	DIGITAL MEDIA LABS	400MW-2	603	DIGITAL MEDIA LABS	
586	PLUSTEK USA, INC	400PC-2	163	TEKTRONIX	328, 329			
944 PRINTERS/PLOTTERS								
416	ASP COMPUTER PRODUCTS	100IS-14	399	BUFFALO PRODUCTS	375	86	CANON USA INC	
398	DIGITAL EQUIP CORP (N.A.)	100A-H	410	E. I. T. LTD	100UK-13	103	EASTMAN KODAK CO	
191	KYOCERA ELECTRONICS (N.A.)	261	441	MINOLTA GMBH	100IS-27	132	NEC	
135	PANASONIC	26, 27	313	ROSE ELECTRONICS	360	163	TEKTRONIX	
165	TEXAS INSTRUMENTS	56, 57	294	WILCO AMS	407			
945 PROGRAMMABLE HARDWARE								
246	B&C MICROSYSTEMS	407	257	IO TECH	407	261	LINK COMPUTER GRAPHICS	
291	OMNITECH ELECTRONICS, INC	408	275-276	TRIBAL MICROSYSTEMS	408	279	XELTEK	
280	Z-WORLD ENGINEERING	408						
946 SCANNERS/OCR/DIGITIZERS								
462	CANON EUROPA N.V.	100IS-13						
947 TAPE DRIVES								
77-78	AMERICAN MEGATRENDS	105	260	LAGUNA DATA SYSTEMS	408	184	MOUNTAIN NETWK SOLU (INT'L)	
268	OVERLAND DATA INC	408	268	QUALSTAR CORP	408	326	VALITEK INC	
948 UPS								
415	AMERICAN POWER CONV	100IS-46	79	AMERICAN POWER CONV (N.A.)	283	319-320	BAY TECHNICAL ASSOC	
200-201	BAY TECHNICAL ASSOC	381	136	PARA SYSTEMS	127	137-138	PC POWER & COOLING	
SOFTWARE								
949 BUSINESS								
19	COMPUTER ASSOCIATES	199	*	COPIA INTERNATIONAL	154	101	DIGITAL RESEARCH INC (N.A.)	
104	FOX SOFTWARE INC	88, 89	*	INTUIT INC	2, 3	473	ITALIAN S/W AGENCY	
35-36	RAINBOW TECHNOLOGIES	175	157	STRATEGIC MAPPING	111			
950 CAD/CAM								
80	AMERICAN SMALL BUSI COMP	95	11	AUTODESK INC	156-158	304	CADSOFT COMPUTER, INC	
562-563	EVOLUTION COMPUTING	400NE-7	26-27	FORESIGHT RESOURCES	223	278	WINTEK CORP	
951 COMMUNICATIONS/NETWORKING								
24	DATASFORM TECHNOLOGIES	169	253	DIVERSIFIED COMPUTER SYS	409	*	GLOBALINK INC	
564-565	GLOBALINK INC	400NE-A-B	452	MINICOM LTD	100IS-38	35-36	RAINBOW TECHNOLOGIES	
449	WALKER, RICHER & QUINN	100IS-45						
952 DATA ACQUISITION								
301	DAVIS INSTRUMENTS	409	*	NATIONAL INSTRU	100IS-60C-D	164	TELEBYTE TECHNOLOGY	
953 DATABASE								
14-15	BORLAND INTERNATIONAL	247	21	COMPUTER ASSOCIATES	183	*	COPIA INTERNATIONAL	
251	DATACAP	409	104	FOX SOFTWARE INC	88, 89	186-187	ODYSSEY DEVELOPMENT	
149	RAIMA CORP	99	39	SEQUIER SOFTWARE INC	225	166	TMS	
170-171	VENTURA SOFTWARE INC	92, 93						
954 EDUCATIONAL								
69-70	ABACUS SOFTWARE	139	8-9	ABACUS SOFTWARE	227	*	AME INSTIT FOR COMP SCI	
83-84	BUREAU OF ELECT PUBL	102	179	LOGICUS INCORPORATED	176			
955 ENGINEERING/SCIENTIFIC								
102	DSP DEV CORP	152	302	GRAMMAR ENGINE, INC	410	221-222	LANDMARK RES INT'L CORP	
126	MATHSOFT INC	253	127	MATHSOFT INC	174	63	MICROCAL INC	
285	NILES & ASSOCIATES INC	238	154	SPECTRUM SOFTWARE	262	161-162	SYSTAT INC	
47-49	WOLFRAM RESEARCH	191						
956 ENTERTAINMENT								
217	MICROPROSE SOFTWARE	379						
957 GRAPHICS								
312	3-D VISIONS	197	91	COREL SOFTWARE	24	22-23	CTX INT'L INC	
254	FLOP CORP	410	105	FRAME TECHNOLOGY	141	61-62	IMAGE NORTH TECH	
266	PATTON & PATTON	323	31-32	NANAO USA CORP	213	*	PACIFIC DATA PRODUCTS	
157	STRATEGIC MAPPING	111	163	TEKTRONIX	328, 329			
958 MACINTOSH								
558-559	KINGLI TECHNOLOGY, INC	400MW-1	575-576	KINGLI TECHNOLOGY, INC	400NE-4	161-162	SYSTAT INC	

*Correspond directly with company.

INDEX TO ADVERTISERS BY PRODUCT CATEGORY

Inquiry No.	Page No.	Inquiry No.	Page No.	Inquiry No.	Page No.	Inquiry No.	Page No.
959	MAIL ORDER	109	IBM CORP. 30,31	426	FAST ELECTRONIC GMBH 100IS-29	30	KEA SYSTEMS LTD. 168
18	COMPUCLASSICS 212	*	MARK WILLIAMS CO 115	106-107	GLENCOE ENGINEERING 326	59-60	LUCAS MANAGEMENT SYS 209
422	COMPUCLASSICS 100IS-6	147	QUANTUM SOFTWARE 363	145-146	PROTECH MARKETING INC 275	*	MICROSOFT CORPORATION 67
423	COMPU SAVE INT'L 100IS-39	964 PROGRAMMING LANGUAGES/TOOLS		307-308	SOFTWARE SECURITY INC 110	*	MICROSOFT CORPORATION 83
425	COMPUTER QUICK 100IS-8	579	ANCOT CORPORATION 400P-8	966 SHAREWARE		*	MICROSOFT CORPORATION 106,107
428	GREY MATTER LTD 100IS-17	417	BLAISE COMPUTING INC 100P-36	*	REASONABLE SOLU 100IS-60A-B	*	MICROSOFT CORPORATION 119
125	PROGRAMMER'S PARADISE 63-85	81-82	BORLAND INTERNATIONAL 17	967 SPREADSHEETS		31-32	NANAO USA CORP 213
150	S'NW ELECTRONICS 108	*	C USERS JOURNAL 100IS-60C-D	12-13	BORLAND INTERNATIONAL 161	33	NATIONAL INSTRUMENTS 239
443	S'NW ELECTRONICS 100IS-16	460	CASE DESIGN 100IS-22	*	MICROSOFT CORPORATION 8,9	68	PACIFIC GOLD COAST 214
58	SEQUEL/KNOWSIS NV 239	424	COBALT BLUE 100IS-16	968 UNIX		37-38	RR SOFTWARE 238
161-162	SOFTLINE CORP 100IS-21	93-94	DATA ACCESS CORP 251	*	MARK WILLIAMS CO 115	51	SYMANTEC/ZORTECH 170,171
960 MATHEMATICAL/STATISTICAL		101	DIGITAL RESEARCH INC (N.A.) 151	130	MORTICE KERN (MKS) 137	407	SYSTEMSTAR 100UK-15
102	DSP DEVELOPMENT CORP 152	402	EDINBURGH PORTABLE COMPIERS 100UK-17	190	SUNSOFT 117	41-42	VENTURA SOFTWARE INC 186,187
409	NAG 100UK-2	401	EXPERT SYSTEMS LTD 100UK-12	47-49	WOLFRAM RESEARCH 191	*	WINDOWS/SDOS JOURNAL 100IS-60C-D
269	SAS INSTITUTE INC 410	428	GREY MATTER LTD 100IS-17	969 UTILITIES		47-49	WOLFRAM RESEARCH 191
155-156	STATSOFT 285	428	INTERACTIVE IMAGE TECH 104	418-419	CLARION SOFTWARE 100IS-37	971 WORD PROCESSING/DTP	
161-162	SYSTAT INC 278	121	LAHEY COMPUTER SYSTEMS 108	424	COBALT BLUE 100IS-16	413	AMDS EUROPE LTD 100IS-15
961 MISCELLANEOUS SOFTWARE		53-54	LIANT SOFTWARE CORP (N.A.) 185	221-222	LANDMARK RES INT'L CORP 269	186-187	ODYSSEY DEVELOPMENT 324
554	ACTION COMP SUPPLIES 400MW-4	55-56	LIANT SOFTWARE CORP (INT'L) 185	144	PKWARE INC 304	*	PACIFIC DATA PRODUCTS 323
571	ACTION COMP SUPPLIES 400NE-5	315-316	LIANT SOFTWARE CORP (N.A.) 361	309	QUARTERDECK OFFICE SYS 120A-P	*	
329	BYTE LISTINGS ON DISK 230	317-318	LIANT SOFTWARE CORP (INT'L) 361	168-169	TOUCHSTONE SOFTWARE 114	*	
593-594	IEPS 400S0-6	*	MICROSOFT CORPORATION 21	172	VERMONT CREATIVE SW 55	972 BOOKS/PUBLICATIONS	
458	ON TIME MKRT/KARSTEN PETERSEN 100IS-60	*	MICROSOFT CORPORATION 142,143	970 WINDOWS		*	C USERS JOURNAL 100IS-60C-D
157	STRATEGIC MAPPING 111	442	MIX SOFTWARE 100IS-35	312	3-D VISIONS 197	287	COMPUBOOKS 409
962 ON-LINE SERVICES		409	NAG 100UK-2	67	AG COMMUNICATION SYSTEMS 179	*	UNIXWORLD 334A-B
* BIX 147		34	POPKIN SOFTWARE 215	311	APPROACH SOFTWARE 167	*	UNIXWORLD 335
450	BIX 424	267	PSEUDOCORP 410	322-323	CELERITE GRAPHICS INC 237	*	WINDOWS/DOS JOURNAL 100IS-60C-D
100	BYTE/DEMOLINK 423	35-36	RAINBOW TECHNOLOGIES 175	20	COMPUTER ASSOCIATES 218	973 MISCELLANEOUS	
*	COMPU SERVE 133,134	37-38	RR SOFTWARE 238	66	CSI PUBLISHING, INC 238	604	BYTE CARD DECK 400MW-6
90	COMPU SERVE 135	444-445	STONY BROOK SOFTWARE 100IS-11	24	DATASTORM TECHNOLOGIES 169	605	BYTE CARD DECK 400NE-6
97	DELPHI 425	178	SYMANTEC/ZORTECH 52	26-27	FORESIGHT RESOURCES 223	332	BYTE EURODECK 164
430	I-COM 100IS-40	570	THE WNDX CORP 400NE-3	61-62	IMAGE NORTH TECHNOLOGIES 222	327	BYTE REPRINTS 276
963 OPERATING SYSTEMS		580	THE WNDX CORP 400PC-1	971 WINDOWS		328	BYTE SUB MESSAGE 236
101	DIGITAL RESEARCH INC (N.A.) 151	173	WATCOM PRODUCTS INC 29	68	CSI PUBLISHING, INC 238	333	BYTEWEEK 243
		965 SECURITY		66	CSI PUBLISHING, INC 238	334	BYTEWEEK 401
		466	AIR TECH 100IS-9	24	DATASTORM TECHNOLOGIES 169	188	DIGITAL CONSULTING INC 345
		75	ALADDIN KNOWLEDGE SYSTEMS 71	26-27	FORESIGHT RESOURCES 223	561	WINDOWS & OS/2 CONFERENCE 400NE-11
		192-193	CERTUS INT'L CORP 80,81	61-62	IMAGE NORTH TECHNOLOGIES 222		

*Correspond directly with company.

BYTE ADVERTISING SALES STAFF:

Jennifer L. Bartel, National Sales Manager, 14850 Quorum Drive, Suite 380, Dallas, TX 75240, tel. (214) 701-8496
Liz Coyman, Inside Advertising Sales Director, One Phoenix Mill Lane, Peterborough, NH 03458, tel. (603) 924-2518

NEW ENGLAND
ME, NH, VT, MA, RI, CT, ONTARIO
CANADA & EASTERN CANADA
Michael Lamatina (617) 860-6344
Patricia Payne (603) 924-2654
McGraw-Hill Publications
24 Hartwell Avenue
Lexington, MA 02173
FAX: (617) 860-6899

SOUTHEAST
NC, SC, GA, FL, AL, TN, MS, AR, LA, KY
(604) 843-4782
Patricia Payne (603) 924-2654
McGraw-Hill Publications
4170 Ashford-Dunwoody Rd., Suite 520
Atlanta, GA 30319
FAX: (404) 252-4056

SOUTHWEST
ROCKY MOUNTAIN
CO, OK, TX
Jennifer Walker (214) 701-8496
Barry Echavaria (603) 924-2574
McGraw-Hill Publications
14850 Quorum Dr., Suite 380
Dallas, TX 75240
FAX: (214) 991-6208

NORTH PACIFIC: Campbell, CA
SILICON VALLEY, HI, WA, AK,
W. CANADA
Bill McAfee (408) 879-0381
Joseph Mabe (603) 924-2662
McGraw-Hill Publications
1999 South Bascom Ave., Suite 210
Campbell, CA 95008
FAX: (408) 879-9067

SOUTH PACIFIC: Costa Mesa, CA
ORANGE COUNTY
SAN DIEGO COUNTY
Beth Dumas (714) 753-8140
Jonathan Sawyer (603) 924-2665
McGraw-Hill Publications
15635 Alton Pk., Suite 290
Irvine, CA 92718
FAX: (714) 753-8147

EAST COAST
NY, NYC, NJ, DC, DE, MD, VA, WV, PA
Kim Norris (212) 512-2645
Ariane Casey (212) 512-2368
Barry Echavaria (603) 924-2574
McGraw-Hill Publications
1221 Avenue of the Americas—
28th Floor
New York, NY 10020
FAX: (212) 512-2075

MIDWEST
IL, MO, KS, IA, ND, SD, MN,
WI, NE, IN, MI, OH
Kurt Kelley (312) 616-3328
MaryAnn Goulding (603) 924-2664
McGraw-Hill Publications
Two Prudential Plaza
180 North Stetson Ave.
Chicago, IL 60601
FAX: (312) 616-3370

NORTH PACIFIC: San Francisco, CA
NORTHERN CA, OR, ID, MT,
WY, NORTHERN NV, UT
Roy J. Kops (415) 954-9728
Leslie Hupp (408) 879-0381
Joseph Mabe (603) 924-2662
McGraw-Hill Publications
425 Battery Street
San Francisco, CA 94111
FAX: (415) 954-9786

SOUTH PACIFIC: Los Angeles, CA
LOS ANGELES COUNTY, AZ,
NM, SOUTHERN NEVADA
Alan El Faye (213) 480-5243
Jonathan Sawyer (603) 924-2665
McGraw-Hill Publications
3333 Wilshire Boulevard #407
Los Angeles, CA 90010
FAX: (213) 480-5249

Regional Advertising
Brian Higgins (603) 924-2651
Larry Levine (603) 924-2637
BYTE Publications
One Phoenix Mill Lane
Peterborough, NH 03458

Peterborough, NH Office: Inside Sales FAX: 603-924-2683 Advertising FAX: 603-924-7507

Hardware/Software Showcase
Mark Stone (603) 924-2685
Ellen Perham (603) 924-2598
BYTE Publications
One Phoenix Mill Lane
Peterborough, NH 03458

The Buyer's Mart (1x2)
Margot Gnade (603) 924-2656
BYTE Publications
One Phoenix Mill Lane
Peterborough, NH 03458

BYTE Deck
Ed Ware (603) 924-2596
BYTE Publications
One Phoenix Mill Lane
Peterborough, NH 03458

EURO-DECK
James Bail (603) 924-2533
BYTE Publications
One Phoenix Mill Lane
Peterborough, NH 03458

BYTE International Direct Response Postcards
Ellen Perham (603) 924-2598
BYTE Publications
One Phoenix Mill Lane
Peterborough, NH 03458

International Advertising Sales Staff:

McGraw-Hill Publishing Co., Wimbledon Bridge House, One Hartfield Road, Wimbledon, London, SW19 3RU, England, Tel: 44 81 543 1234, Fax: 44 81 540 3833

GERMANY, SWITZERLAND, AUSTRIA, UNITED KINGDOM
Ron Cordek, Managing Director
European Operations
Christina Barton (44 81 545 6270)
McGraw-Hill Publishing Co.
Wimbledon Bridge House
One Hartfield Road
Wimbledon, London SW19 3RU
England
Tel: 44 81 543 1234
FAX: 44 81 540 3833
TELEX: 892191

BENELUX
Ellen Pardeede
Balenburg 105
3437 AB Nieuwegein
The Netherlands
Tel: 31 34 02 49496
FAX: 31 34 02 37944

HONG KONG
William Chu
Seavex Ltd
503 Wilson House
19-27 Wyndham St
Central, Hong Kong
Tel: (852) 868-2010
FAX: (852) 810-1283
TELEX: 60904 SEVEX HX

AUSTRALIA
Ian McDonald
Hugh Anderson Pty. Ltd.
119 Market Street
South Melbourne, Australia
Tel: (61) 3-696-5411
FAX: (61) 3-696-5692

KOREA
Jeon-Gwon Seo
DooBee International Limited
Center Building (Byulgwang)
1-11 Jeong-dong, Choong-ku
C. P. O. Box 4557
Seoul, Korea
Tel: (82) 2 776-2096
FAX: (82) 2 755-9860
TELEX: 787-27117

SINGAPORE
Jocelyn Domingo
Seavex Ltd
400 Orchard Road, #10-01
Singapore 0823
Republic of Singapore
Tel: 65 734 9790
Fax: 65 732 5129
TELEX: RS35539 SEAVEX

FRANCE, ITALY
Zena Coupé, Amanda Blaskett
A-Z International Sales Ltd.
70 Chalk Farm Road
London NW1 8AN
England
Tel: 44 71 284 3171
FAX: 44 71 284 3174

TAIWAN
Summer Chien
Candice Lo
Acer TWP Corp.
19-2, Lane 231,
Fu Hsing North Road
Taiper 10445, Taiwan
R. O. C.
Tel: (886) 2 713 6959
FAX: (886) 2 713 1950

INDIA
Ronny Mistry
Ronny Mistry Associates Pvt Ltd
Shrinabad
581 Jam-E-Jamshed Rd
Matunga
Bombay 400019, India
Tel: (91) 22-413-7396
FAX: (91) 22-204-4973

PHILIPPINES
Luis Nunez
Far East Media Consultants
806 B Filipinas Life Bldg.
6786 Ayala Ave.
1200 Makati
Metro Manila, Philippines
Tel: (63) 2-810-1330
FAX: (63) 2-818-1974

PAKISTAN
Arif Salahuddin
INS Media Sales (Pvt) Ltd
205, 2/F, Panorama Centre
Patina, Jinnah Road
Karachi, Pakistan
Tel: (92) 21-526-901
FAX: (92) 21-526-207

JAPAN
Masaki Mori
McGraw-Hill Publishing Co.
Overseas Corp.
Room 1528
Kasumigaseki Bldg.
3-2-5 Kasumigaseki,
Chiyoda-Ku
Tokyo 100, Japan
Tel: 81 33 581 9811
FAX: 81 33 581 4018

ISRAEL
Dan Ehrlich
Ehrlich Communication
International
P.O. Box 11297
Tel Aviv 61112, Israel
Tel: 972-52-586 245
Tel: 972-52-586 248
FAX: 972-52-586 885

INDONESIA
Paula Kalangie
Pacific Intermedia
14/F, Arthaoka Bldg.
Jalan Jend. Sudirman No. 2
Jakarta Pusat, Indonesia
Tel: (62) 21-586-611
FAX: (62) 21-720-2609

FREE Software Instantly On-Line With BYTE DEMOLINK



Download free demo software from top publishers directly to your computer. . . for just the cost of a phone call!

BYTE DEMOLINK lets you preview software instantly by calling the telephone number in the city nearest you. All you need to access BYTE DEMOLINK is a PC, a modem and a telecommunications program. The latest demo software is at your fingertips for your evaluation.

Call BYTE DEMOLINK today to connect with these free software demos—it's only a phone call away!

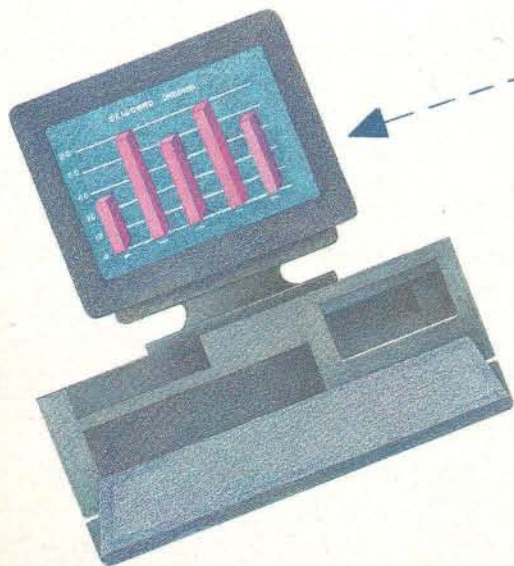

Here are the newest software packages available on DEMOLINK:

AutoPACK Tutor

A powerful interactive computer-based AutoCAD training program for novice or experienced users. Tutor starts with an introductory module on the basics of AutoCAD, includes an exercise module that takes the user through step-by-step instructions of object snap, dimensioning, blocks, etc., and has a complete on-line reference system that replaces AutoCAD "Help" with animated examples and clear explanations. AutoPACK Tutor by Gräbert Systems, Inc.

Select the file aptdemo.exe

TropicSoft C++ Classes

A set of the most efficient and complete C++ classes for building MS-DOS Windows application interfaces. Designed to dramatically reduce memory and exe size, increase execution speed and reduce lines of code by as much as 80%. Also features the flex "C" programming to compile in any memory model and run in any Windows mode. (Source code available.)

Select the file tsdemo.exe

WINFAX PRO 2.0

Send and receive laser quality faxes from any Windows 3 application directly to any fax device or your PC. WINFAX PRO is recognized by Windows as a print device so a single fax can be composed from within pages of different Windows applications. Specify at what date and time the fax will be sent, and WINFAX PRO will send the fax to either one recipient or a group of recipients. Faxes can be printed or viewed upon receipt. WINFAX PRO manages fax numbers, recipients and groups with its built-in phonebooks. Cover pages can be fully customized to include log files, ASCII text files and fax merge capabilities. Call 1-800-268-6082 for more information.

Select the file winfax.exe

ZyINDEX

ZyINDEX, by ZyLAB Corp., is the premiere text retrieval system for DOS and Windows. Search thousands of documents in seconds, regardless of where documents are located or with what word processor they were created.

Select the file zyindex.exe

DEMOLINK Windows

Use our new Windows front-end software to automate your DEMOLINK sessions.

Select the file dlwin.exe

Other Software Packages Available:

ASQ, by Qualitas

C++/Views, CNS, Inc.

C-Scape with Look & Feel, Liant Software Corp.

BYTE Free Demo Download
DEMOLINK 617-861-9767*

*Call the nearest DEMOLINK office anytime. Telecom settings: 2400 or 1200 baud, 8 data bits, 1 stop bit, and no parity. Enter DEMOLINK at the prompt.

Chicago 312-616-1071 Denver 303-220-0328 Los Angeles 213-383-9856 New York 212-797-5620 San Francisco 415-434-4510 Toronto 416-960-3187 Washington, DC 202-463-4920

Where Do You Go for Help When You're the Expert?

BIX – the On-Line Service for People Who Know Computers!

Get answers, advice and code from top programmers, designers, and consultants. BIX is home to hardware and software engineers, systems designers, independent consultants, technology buffs and computer industry celebrities. *All sharing information on their favorite subject ... computing!* And the resources on BIX are substantial.

More High-Quality Tools and Information on BIX.

Our software libraries are packed with the latest high-quality tools, programs and code to help you do a better job. So, whether you're looking for a special utility, TSR, highly qualified advice or just stimulating conversation, you'll find it on BIX.

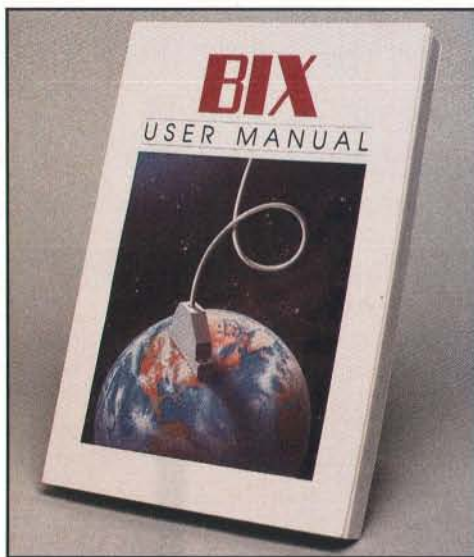

Get Answers in These Conferences and Many Others:

borland	Borland International official technical support
c.plus.plus	Discuss the C++ programming language
ibm.windows	IBM/Microsoft Windows
ibm.os2	OS/2 Operating System
ibm.utils	Utility software for IBM Computers
microsoft	Products from Microsoft

Subscribe to BIX On-line for Only \$39 a Quarter Now!

Just set your telecommunications program for full duplex, 2400 or 1200 baud, 7 bits, even parity, 1 stop bit. Get your Visa, MasterCard, or American Express card ready. Have your modem call 617-861-9767*, enter "bix" at the prompt. When you are prompted for "Name?" enter "bix.deal" and complete on-line registration.

Money-Back Guarantee!

Try BIX for 30 days and if you're not completely satisfied, call Customer Service and we'll refund your subscription fees. **But if you decide BIX is for you, we'll give you an additional 30 days on your annual subscription.**

*Connect to BIX locally via BT Tymnet—call 800-336-0149 for your local access number; fees are outlined on-line. Bix handles billing for BT Tymnet connect fees. Other access available. Call BIX at 800-227-2983 or 617-354-4137 for more information.

YOU MIGHT FIND AN ONLINE SERVICE FOR LESS, BUT THERE ARE PROBABLY SOME STRINGS ATTACHED.

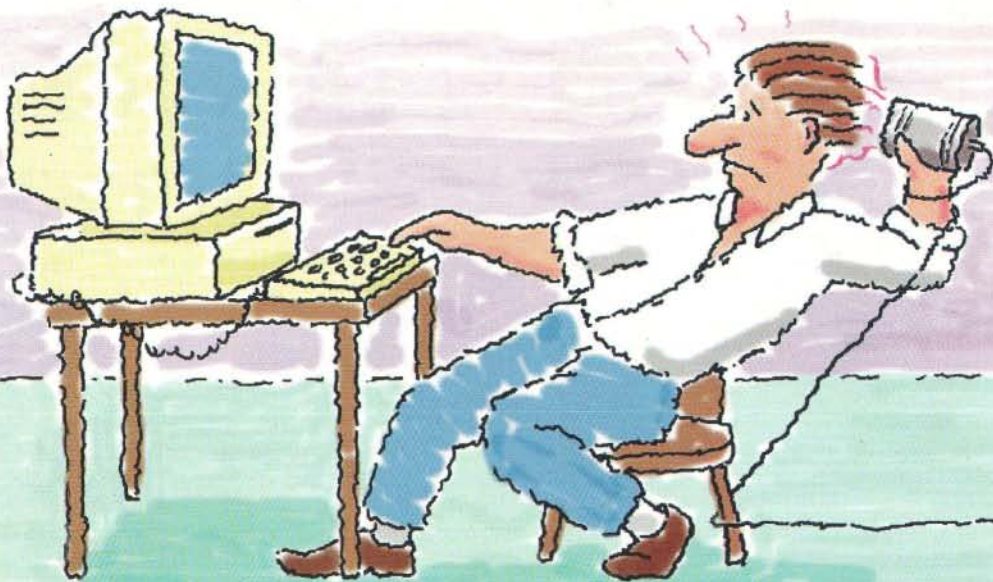

Special Trial Offer: 5 hours for \$5!

Some online services charge a monthly fee for "unlimited access."

This might sound like a good deal.

But take a closer look: the monthly fee doesn't include

any of the services you want! All of the valuable features, like downloadable programs, chat, and multi-player games cost extra—sometimes a lot extra. With DELPHI's 20/20 Advantage Plan, you get 20 hours for only \$20—that's 20 hours of real productivity and



Downloadable Programs

Download from file libraries with thousand of programs. Join groups for nearly every type of computer and other special interests.



E-mail



Special Interest Groups

Chat with members from around the world. Send unlimited electronic mail messages. You can even challenge

your skills in lively multi-player games. And all within easy reach: just connect with a local phone call from over 600 cities and towns.

Trial Offer: 5 hours for \$5!

Try DELPHI at \$1 per hour. Join today and get 5 hours of evening and week-end access for only \$5. If you're not satisfied, simply cancel your account before the end of the calendar month with no further obligation. Keep your account active and you'll automatically be enrolled in the 20/20 plan for the next month. So don't be strung along by another online service—get it all for less with DELPHI!



Worldwide Chat Lines

Give DELPHI a try...Register Now!

Dial by modem 1-800-365-4636
Press RETURN once or twice
At Password, enter BT55

Rates apply for evening and weekend access from within the mainland US. There is a one-time enrollment fee of \$19 when you join the 20/20 Advantage Plan.



Multi-player Games

entertainment, using the features you expect from a quality online service.

DELPHI

A service of General Videotex Corporation,
1030 Massachusetts Avenue, Cambridge, MA 02138
Phone: 1-800-695-4005



STOP BIT

WILLIAM F.
BUCKLEY JR.

REFLECTIONS ON THE "PRIVACY" QUESTION

Who benefits when your medical records go on-line?

You have gonorrhea. No, that's unctuous. I have gonorrhea. As of Monday, who knew this? The lab technician to whom Dr. Klein sent my blood for testing, and he knows only that "BS 3/1/92/13—Klein #493399" (blood sample tested on March 1, 1992, number 13 of the blood samples directed to the laboratory by Dr. Klein, whose license to practice medicine in New York is number 493399) came up positive on a gonorrhea test. Now your doctor knows, his nurse knows, and you know. Should anyone else know?

That question reaches into the library of questions confronted by the recently established United States Privacy Council.

Let us suppose that the doctor asks you—as the Consumer Interest Research Institute demands he do, before giving anyone access to the information he collects from his patients—whether you will permit him to furnish your medical data to the Physician Computer Network.

"Will anyone have my name?"

"No. You will be merely a numbered patient."

"OK. But will Mr. Hired Sleuth be able to find out from the Physician Computer Network that Dr. Klein has four patients with AIDS, eight with venereal disease, and one with Kreutzfeld syndrome?"

Dr. Klein had never been asked that question. He pauses. "The Physician Computer Network is interested not in 'my' patients, but in every doctor's patient-histories; interested in the number of patients with this disease or the other (is the number growing? diminishing?)."

Dr. Klein asked me to come over and have a look at what comes out at the other end of the medical-research computer. "Yesterday," (he draws up the information on the screen) "we had this perplexing patient." I note that the name of the patient is given in code. Dr. Klein points to the four symptoms.

"I did not see a pattern in those four symptoms, which included a rash under the right ear. I sent the data into the Physician Computer Network, and in about 1 minute, I was told that these symptoms in the past have indicated a very rare disease called Lombardicunctis, one treatment for which is 200 grams of Glasisturine injected into muscle tissue behind the neck. I did this. The boy's fever this morning is gone, also the rash."

"What about my gonorrhea? If I get appointed to the Supreme Court, is there any way the government inves-

tigators could find out? They would discover, easily enough, that you are my doctor. If they came to you, you would say that my medical records are private."

Yes, and the investigators could go to the pharmacy and try to find out what pharmaceuticals regularly go to my New York apartment. But assuming that they succeeded in bribing the pharmacist, they still are pretty well up against it, since there is no drug labeled, "For exclusive use against the clap."

The privacy nuts, in my judgment, will have a hard time. I say this though I believe passionately in privacy and would willingly serve as the jailkeeper at any penitentiary that collected violators of those privacy laws that do make sense. But which are they?

Last December, Congress passed the Telephone Consumer Protection Act, the purpose of which is to enable you to block salespeople from access to your telephone. Fair enough. There is a law that forbids rental agencies from giving out the record of your patronage of their videotapes. It is a very old law, and a good one, that protects your income tax returns from scrutiny by the tabloids or, for that matter, by the *New York Times*.

When my brother served in the Senate, he introduced a law that gave to students the right to examine the dockets, containing faculty evaluations of their work, that follow them about—sometimes for the rest of their lives. Jim's law is understandable—one faculty grouch or spurned lover should not be allowed indelibly to stain your academic record without challenge. On the other hand, it proves more difficult to get faculty to express themselves freely if they know that the subject will see what they write.

It is, in short, a vexed question. The presumption should always be in favor of privacy, but presumptions are rebuttable, and the data in most of the cases here examined suggest that they have been rebutted. My gonorrhea record—taking into account my allergies, the derivative treatment of it, its effect on me—is data with a useful life for others, and it is thoughtless and selfish to deprive the Physician Computer Network of such use as my little iniquity might provide others, bent on sinning 70 x 7 times.

So that, then, is the rule: In favor of privacy arrangements presumptively. But then listen, listen to the other side. It is often compelling. ■

William F. Buckley Jr.'s forthcoming book is called WindFall: The End of the Affair. You can reach him on BIX c/o "editors."

CONTROL UP TO 96 PC FILE SERVERS WITH 1 KEYBOARD AND MONITOR USING...

COMMANDER

by cybex



- **Select via Keyboard**
- **Dual access up to 250 feet away (optional)**
- **No external power**
- **Mix PC, PC/XT, PC/AT and PS/2**
- **"AutoBoot™" Feature boots attached computers without operator intervention**
- **Shows PC power status**

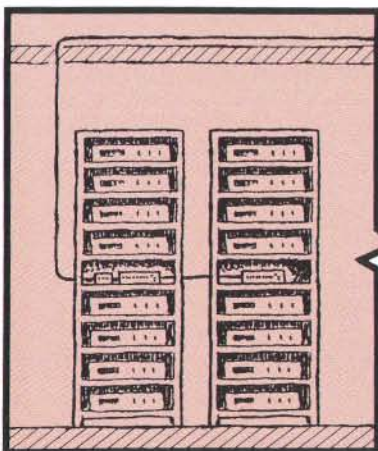
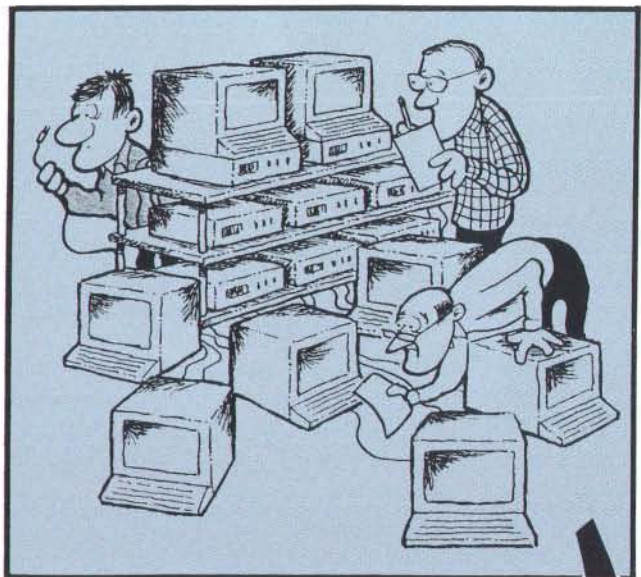

- **PS/2 Mouse support available**
- **Each unit accommodates from 2 to 8 PCs**
- **Up to 12 units can be cascaded**
- **Mounting kit available for 19" and 24" rack installation**

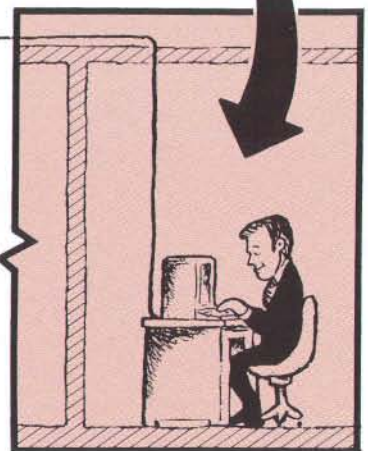

Dealer Program Available

Cybex Corporation

2800-H Bob Wallace Ave.
Huntsville, Alabama 35805.

(205) 534-0011

Fax (205) 534-0010

PC, PC/XT, PC/AT and PS/2 are trademarks of International Business Machines Corp.

Cut Your Server Storage Costs by 30% ...

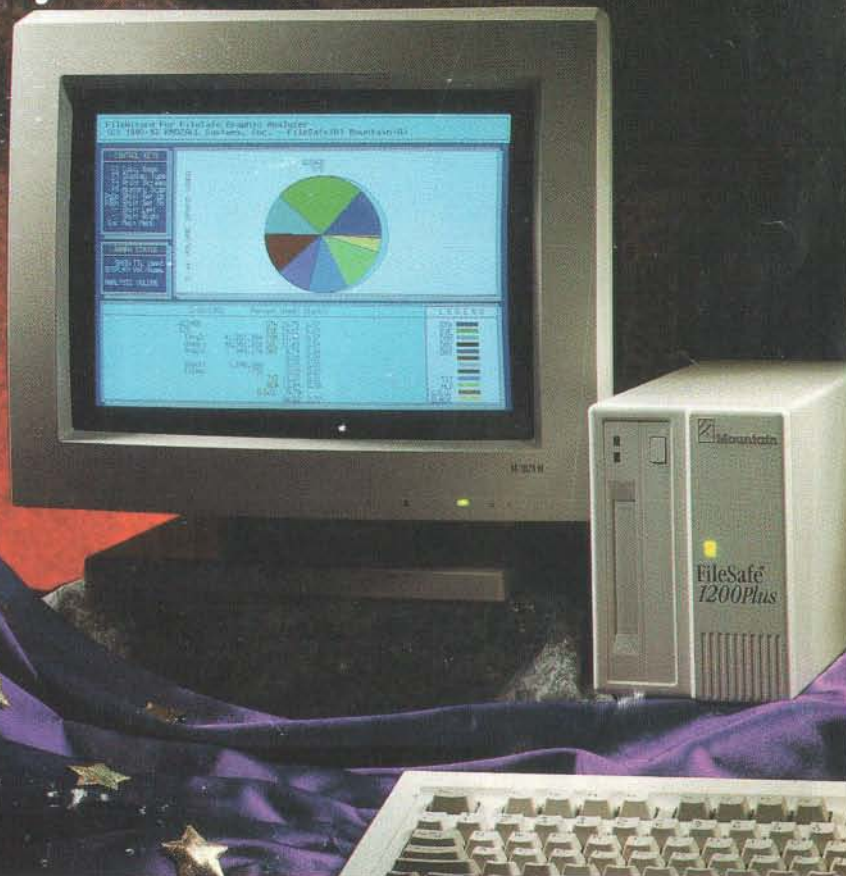

And manage your server disk, too!

Mountain®, the leader in tape storage management now makes network storage management easier. Mountain's FileWizard® for FileSafe® is the breakthrough you've needed in Novell® NetWare® file server management. Get 30% of your server disk space back the first time you use FileWizard for FileSafe, and analyze your server to see how it is being used.

FileWizard for FileSafe brings you:

- Server Grooming
- File Migration and Archiving
- Server Storage Analysis & Reporting
- Archive Librarian

Mountain combines the analysis, grooming, and archiving functions of the widely acclaimed FileWizard with the security of Mountain's award winning FileSafe tape subsystems. FileWizard for FileSafe provides a powerful data management solution for today's Novell NetWare file servers. Automate archiving files to Mountain's FileSafe tape subsystems and retrieve them off tape with the FileWizard for FileSafe Librarian.

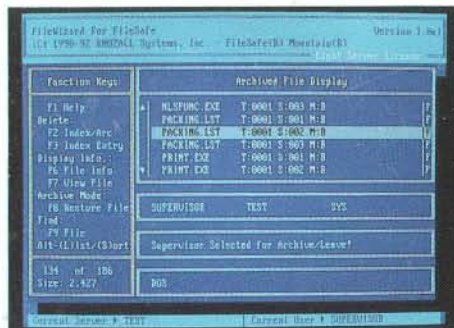

Automate your file grooming and archiving jobs. Retrieve files using the Librarian.

FileWizard for FileSafe works with all of Mountain's FileSafe subsystems. And it comes in one, three, and eight server versions.



Call 408-379-4300 (USA) or 44-276-686454 (EUROPE) for more information.

Circle 184 on Inquiry Card.